



Installation Instructions

HighRock 4x4™ Rear Bumper

Vehicle Application: 1986 - 2006 Jeep® Wrangler and Wrangler Unlimited

- HighRock 4x4™ Rear Bumper
Part Number: 42903
- HighRock 4x4™ Departure Roller™
Part Number: 42905

www.Bestop.com - We're here to help! Visit our web site and click on "[Ask a Question](#)". Click here for more [Jeep® Accessories by Bestop](#).

INSTALLATION TIME	SKILL LEVEL
 1-1/2 Hours	 3 - Moderately Difficult
TOOLS	
 18mm, 19mm and 15/16"	 18mm and 19mm
 Safety Glasses	



⚠ WARNING This product is designed primarily to enhance the appearance of the vehicle. Do not rely in any way on the components of this product to protect against injury or death in the event of an accident. Never operate the vehicle in excess of manufacturer's specifications.

WEAR SEAT BELTS AT ALL TIMES

Read and follow, precisely, all installation instructions provided when installing product. Failure to do so may result in a poor fit and could place occupants of the vehicle in a potentially dangerous situation.

HighRock 4x4™ Rear Bumper Installation Instructions

Parts List and Hardware Identification

□ Rear Bumper, Part Number 414.44, Qty - 1

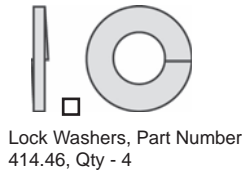
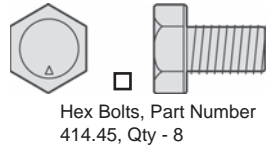
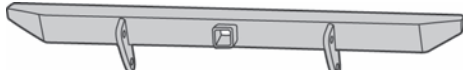

42905 HighRock 4x4™ Departure Roller™

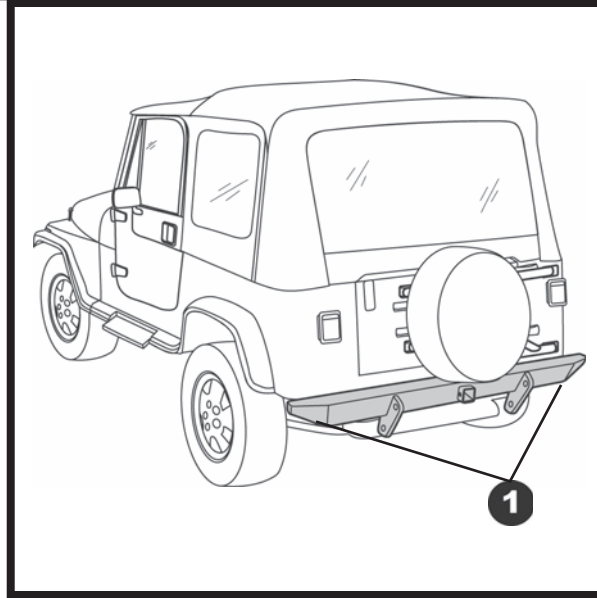
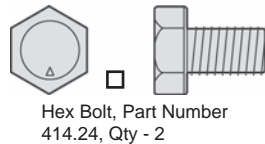
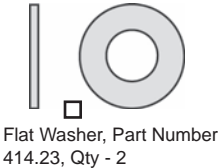

CAUTION

Two or more people may be required to lift the bumper safely.

1 Remove the Original Bumper

Use a socket wrench and an 18mm socket to remove the two (2) bolts on each end of the bumper that attach it to the frame.

Remove the 18mm bolts that attach the bumper to the frame, one under each end of the bumper. Set the bolts aside to be used to install the HighRock 4x4™ Rear Bumper.

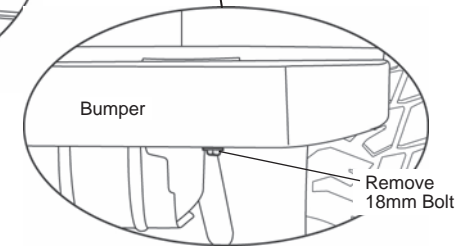
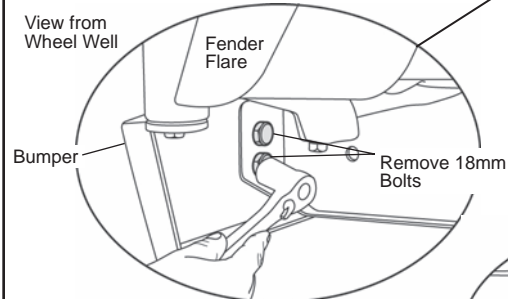
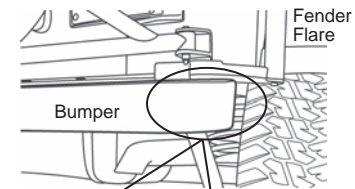

HighRock 4x4™ Rear Bumper Installation Instructions

CAUTION Two or more people may be required to lift the bumper safely.

2 Install Rear Bumper

Place the HighRock 4x4™ Rear Bumper on the vehicle and install two (2) Hex Bolts from the parts kit on each side of the vehicle for '97 - '06 Wranglers. For '86 - '96 Wranglers install four (4) Hex Bolts. Then reinstall the 18mm Bolt under the bumper on each side of the vehicle.

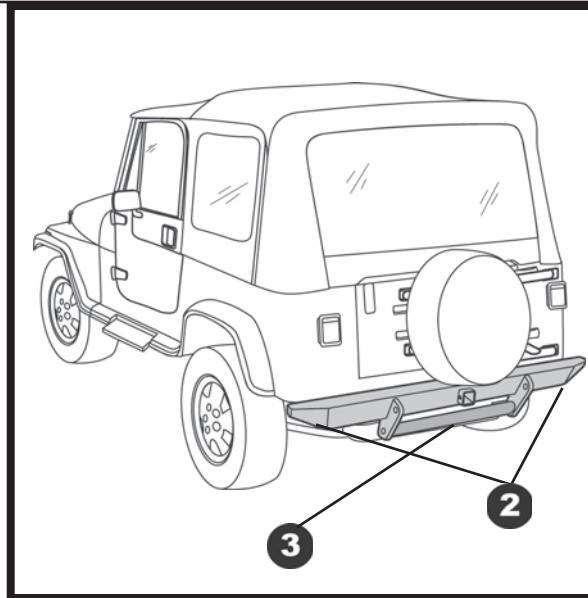
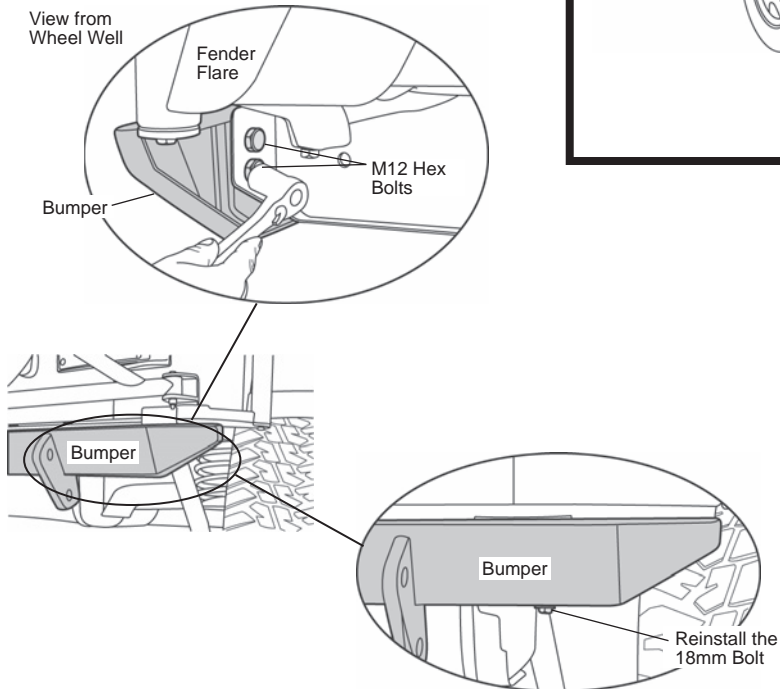

3 Install 42905 HighRock 4x4™ Departure Roller™ – Sold Separately

Place the Roller between the flanges on the Rear Bumper and align the holes in the Roller with the holes in the flange. Slide the Rod through the flanges and the Roller. Install a Hex Bolt and a Washer in each end of the Rod to secure it to the flanges.

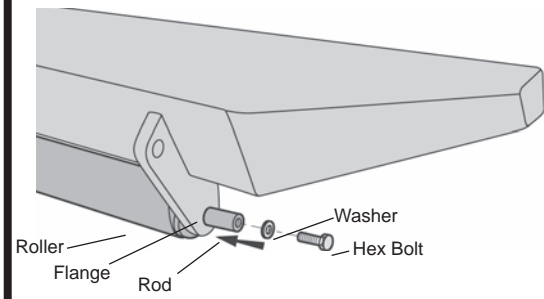

WARNING Tow Rating Warning

Do not exceed the vehicle manufacturer's recommended towing capacity.

WARNING DO NOT cut, drill, weld or modify the Bumper.

HighRock 4x4™ Rear Bumper Installation Instructions

Limited Warranty

We warrant our product to be free from defects in material and workmanship, for the terms specified below, provided there has been normal use and proper maintenance. This warranty applies to the original purchaser only. All remedies under this warranty are limited to the repair or replacement of any item or items found by the factory to be defective within the time period specified.

If you have a warranty claim, first you must call our factory at the number below for instructions. You must retain proof of purchase and submit a copy with any items returned for warranty work. Upon completion of warranty work, if any, we will return the repaired or replaced item or items to you freight prepaid. Damage to our products caused by accidents, fire, vandalism, negligence, misinstallation, misuse, Acts of God, or by defective parts not manufactured by us, is not covered under this warranty.

THE WARRANTY TIME PERIOD IS AS FOLLOWS: ALL "PRODUCTS" MANUFACTURED BY OUR COMPANY: ONE YEAR FROM DATE OF PURCHASE.

ANY IMPLIED WARRANTIES OF MERCHANTABILITY AND/OR FITNESS FOR A PARTICULAR PURPOSE CREATED HEREBY ARE LIMITED IN DURATION TO THE SAME DURATION AND SCOPE AS THE EXPRESS WRITTEN WARRANTY. OUR COMPANY SHALL NOT BE LIABLE FOR ANY INCIDENTAL OR CONSEQUENTIAL DAMAGE.

Some states do not allow limitations on how long an implied warranty lasts, or the exclusion or limitation of incidental or consequential damages, so the above limitations or exclusions may not apply to you.

This warranty gives you specific legal rights, and you may also have other rights which vary from state to state.



For further information or request for warranty work, please contact:
Bestop Inc. Customer Service
(800) 845-3567
(303) 465-1755