

3. Once all 4 Winch bolts have been started, tighten them. Installation of the Winch and the Winch Spacers is now complete! Proceed with the remainder of the installation as demonstrated in the main Bumper Installation Instructions.

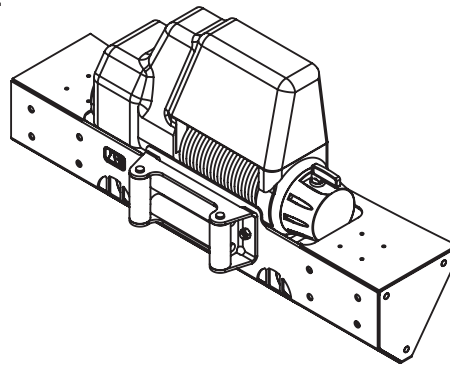

Congratulations on the purchase and installation of a quality Rugged Ridge product! Ask your retailer about the following additional accessories to the JK Modular HD Bumper:

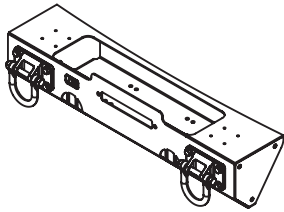

11540.10 - Winch Center Section

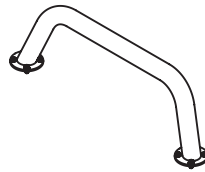

11540.14 - Optional Hoop - Black
11540.16 - Optional Hoop - Stainless

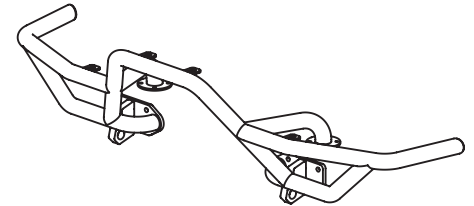

11540.17 - Optional RRC Hoop

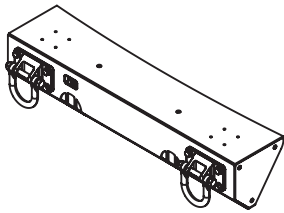

11540.11 - Non-winch Center Section

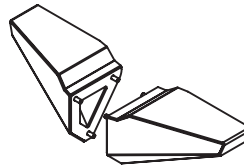

11540.12 - Optional Bumper Ends

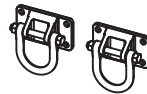

11540.17 - Optional Stainless D-Rings

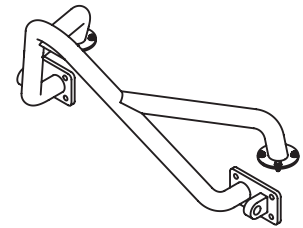

11540.13 - Optional Stinger

LIMITED 90 DAY WARRANTY
Applies to Rugged Ridge by Omix-Ada Inc. Products

Rugged Ridge Off Road (the Company) warrants to the original purchaser of this product that should the product or any part thereof, under normal use and conditions, be proven defective in material or workmanship within 90 DAYS from the date of original purchase, such defect(s) will be repaired or replaced or credited at the Company's sole option.

To obtain repair or replacement within the terms of this Warranty, the product is to be delivered with proof of warranty coverage (e.g. Dated bill of sale), specification of defect(s) to the place of purchase or, with prior approval from the Company (Return Authorization Number is required), freight pre-paid to the Company address listed below.

This warranty does not apply to any product or part thereof which, in the opinion of the Company, has suffered or been damaged through alteration, improper installation, mishandling, misuse, neglect, accident or by acts of nature. THE EXTENT OF THE COMPANY'S LIABILITY UNDER THIS WARRANTY IS LIMITED TO THE REPAIR OR REPLACEMENT PROVIDED ABOVE AND, IN NO EVENT, SHALL THE COMPANY'S LIABILITY EXCEED THE PURCHASE PRICE PAID BY PURCHASER FOR THE PRODUCT.

This Warranty is in lieu of all express warranties or liabilities. ANY IMPLIED WARRANTIES, INCLUDING ANY IMPLIED WARRANTY OF MERCHANTABILITY, SHALL BE LIMITED TO THE DURATION OF THIS WRITTEN WARRANTY. ANY ACTION FOR BREACH OF ANY WARRANTY HEREUNDER INCLUDING ANY IMPLIED WARRANTY OF MERCHANTABILITY MUST BE BROUGHT WITHIN THE PERIOD OF 90 DAYS FROM DATE OF ORIGINAL PURCHASE.

IN NO CASE SHALL THE COMPANY BE LIABLE FOR ANY CONSEQUENTIAL OR INCIDENTAL DAMAGES FOR BREACH OF THIS OR ANY OTHER WARRANTY, EXPRESS OR IMPLIED, WHATSOEVER. No person or representative is authorized to assume for the Company any liability other than expressed herein in connection with the sale of this product.

Some States do not allow limitations on how long an implied warranty lasts or the exclusion or limitation of incidental or consequential damage, so the above limitations may not apply to you. This warranty gives you specific legal rights and you may also have other rights, which vary from state to state.

Omix-Ada Inc.
460 Horizon Dr. Suite 400
Suwanee, Georgia 30024