



3651 N Highway 89 • Chino Valley, AZ 86323
(928) 636-7080 • www.p-a-g.net

JEEP WRANGLER, RUBICON, UNLIMITED (TJ & TJL) 1" BODY LIFT KIT INSTALLATION INSTRUCTIONS 1997-2006 KIT# 951

⚠WARNING

Installation of a Performance Accessories body lift will change the center of gravity and the handling characteristics of the vehicle. Because of the higher center of gravity and larger tires, the vehicle will handle and react differently both on and off road. You must drive it safely! Extreme care must be taken to prevent vehicle rollover or loss of control, which could result in serious injury or death. Avoid sudden sharp turns or abrupt maneuvers and always make sure all vehicle occupants have their seat belts fastened.

⚠WARNING

Read and understand all instructions, warnings, cautions, and notes in this sheet and in your owners manual before you begin the installation of this body lift kit.

⚠CAUTION

Proper installation of a Performance Accessories body lift kit requires knowledge of the factory recommended procedures for disassembly and assembly of original equipment components. We recommend that the factory shop manual and any special tools necessary to your vehicle be on hand during the installation. Installation of this body lift kit without proper knowledge of the factory recommended procedures may affect the performance of these components and the safety of your vehicle. We strongly recommend that a certified mechanic familiar with the installation of similar components install this body lift kit.

⚠WARNING

This body lift kit should only be installed on vehicles in good working condition. Before installation, the vehicle should be thoroughly inspected for evidence of corrosion or deformation of the sheet metal around the factory body mounts. This body lift kit should not be installed on any vehicle that is suspected to have been in a collision or misused. Off road use of your vehicle with this body lift installed may increase the stress applied to the factory body mounts. We do not recommend that any vehicle with a body lift installed be involved in any extreme off road maneuvers such as jumping. Failure to observe this warning may result in serious personal injury and/or severe damage to your vehicle.

⚠WARNING

Many states now have laws restricting bumper heights and vehicle lifts. Local laws should be consulted to determine if the changes you intend to make to your vehicle comply with state laws. Before combining a body lift with a suspension lift, consult an installation professional to see how this will affect your specific application.

⚠WARNING

The installation of larger wheel and tire combinations may reduce the effectiveness of the Anti-lock Braking System.

⚠WARNING

We will not warranty any damage to the a/c system.

⚠WARNING

Always wear eye protection when operating power tools.

⚠WARNING

Ensure that your vehicle tires are properly blocked and secured before you begin installation of this lift kit.

⚠WARNING

To ensure the Supplemental Restraint System (SRS, or air bag) is not accidentally deployed during lift kit installation, always ground yourself and the vehicle. Do not use power or pneumatic tools. Exercise extreme caution while working near SRS sensors and wiring. Do not allow anyone near air bags during lift kit installation. Accidental deployment can result in serious personal injury or death.

⚠NOTE

Performance Accessories recommends using the Loctite® supplied in the kit on all hardware unless noted in the instructions.

A. Before you start.

⚠NOTE

As you read through this procedure, note that each part referenced has the same callout number throughout. Also, the part number in the text matches the corresponding part number in the art. Kit parts are prefaced by the word *kit* in italics.

1. Read all warnings and instructions completely and carefully before you begin.
2. Check to make sure the kit is complete (refer to the Parts List).
3. Only install this kit on the vehicle for which it is intended. If anytime during the installation you encounter something different from what is outlined in the instructions, call [technical support](#) at (928) 636-7080.
4. Park vehicle on a clean, dry, flat, level surface and block the tires so vehicle cannot roll in either direction.
5. Disconnect both battery cables. Disconnect the negative cable (1) first, then the positive cable (2) from the battery (3).

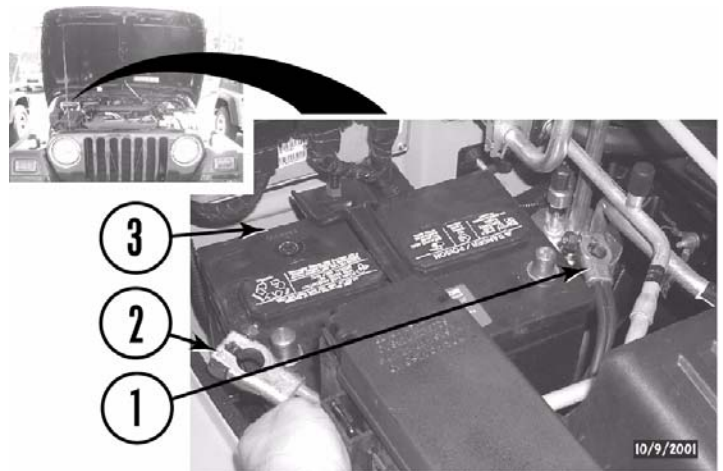

6. Open glove box (4), remove strap (5) from glove box. Remove glove box from dash (6) and vehicle.

⚠NOTE

Fuse locations may vary. Check fuse chart in owners manual.

7. Remove airbag fuse (7) from fuse panel (8). See owners manual for fuse location.

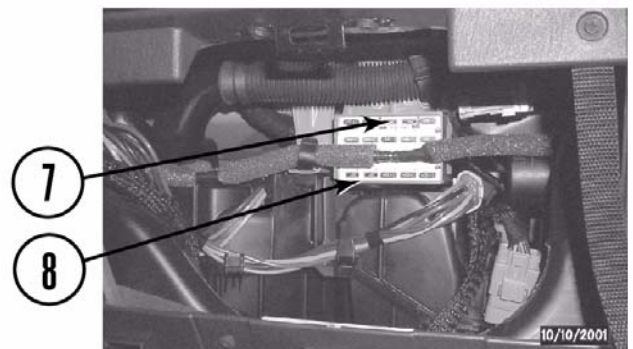
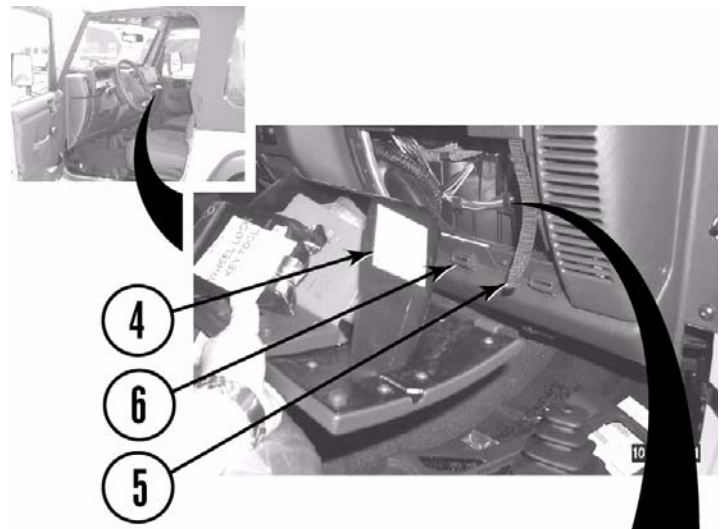

B. Get ready to install the kit.

1. Jeep front bumper cover.

- a. Remove four bolts (9) and plastic cover (10) from frame (11) and front bumper (12).

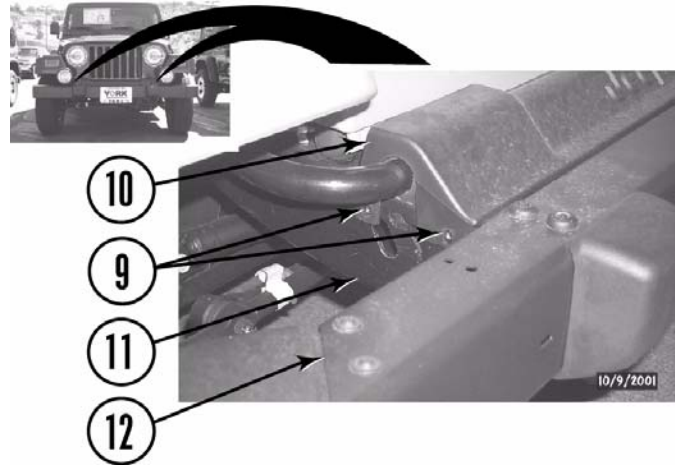

2. Headlights.

- a. Remove six screws (13) and two headlight bezels (14) from core support (15) and vehicle.

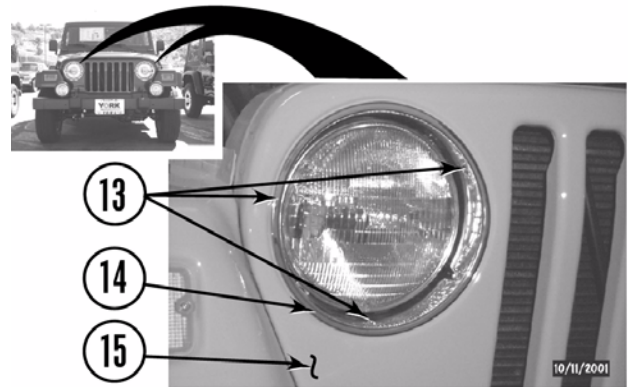

- b. If equipped with a second set of headlights on front bumper, remove two push clips (16) and wiring harness (17) from fenders (18).

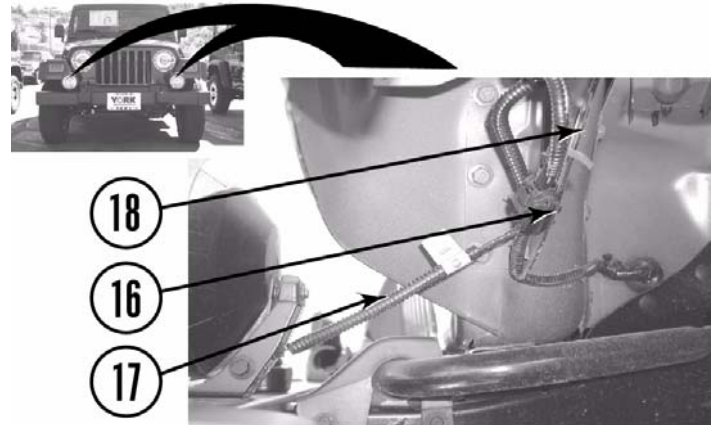

3. Under the hood (radiator).

- a. Remove overflow hose (19) and overflow bottle (20) from fan shroud (21), radiator (22), and vehicle.

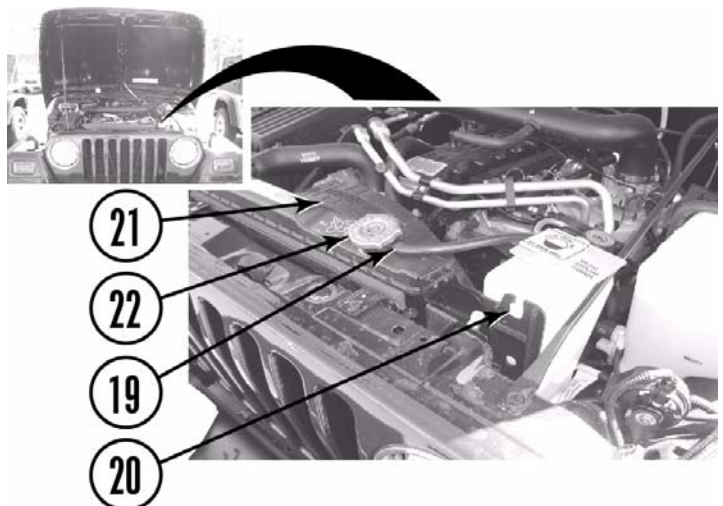

△NOTE

Skip step B.3.b. if vehicle is not equipped with A/C.

- b. Remove four fan shroud mounting bolts (23) from fan shroud (21) and radiator (22).
- c. Remove six radiator mounting bolts (24) and radiator (22) from core support (15). Let fan shroud and radiator rest against fan.

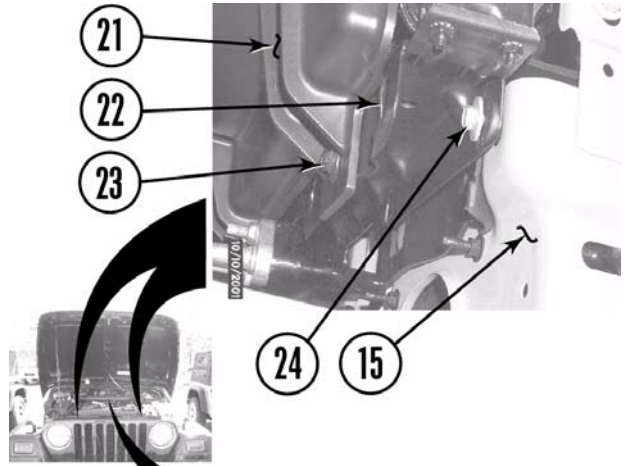

4. Under the hood (air intake).

- a. Remove vacuum hose (25) from air intake (26).
- b. Remove two clamps (27) and air intake (26) from air filter box (28), throttle body (29), and vehicle.

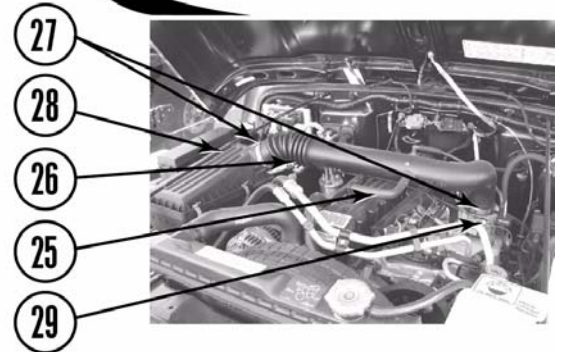

5. Under the hood (steering carrier bearing).

- a. Remove two bolts with captive washers (30) and steering carrier bearing bracket (31) from frame (11).

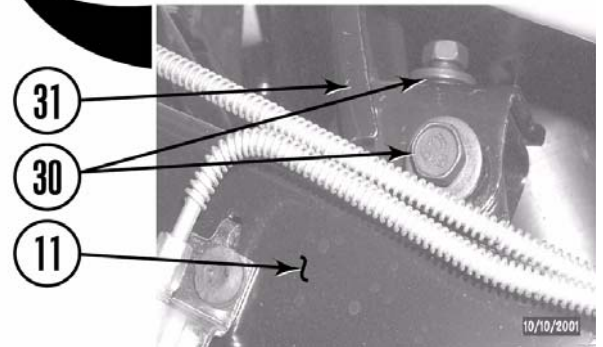

△NOTE

If your jeep is equipped with an automatic transmission skip steps B.6.a through B.6.e.

△NOTE

Automatic transmission models come equipped with a cable shifting mechanism. Care should be taken to make sure the cable shifting mechanism remains flexible and loose during the lifting process.

6. Inside cab (manual transmission).

- a. Remove shift pattern display cap (32) from transmission shift knob (33).
- b. Remove locknut (34) and transmission shift knob (33) from transmission shift lever assembly (35).

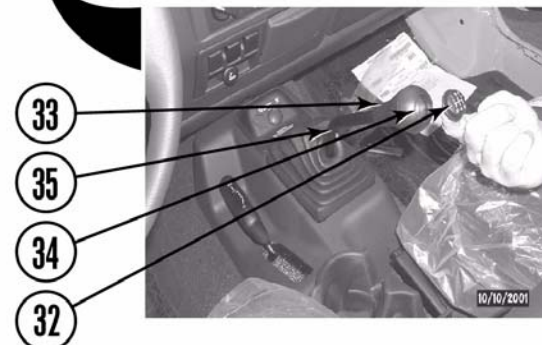

- c. Squeeze and remove manual shift lever cover (36) from shift lever console (37) and transmission shift lever assembly (35).

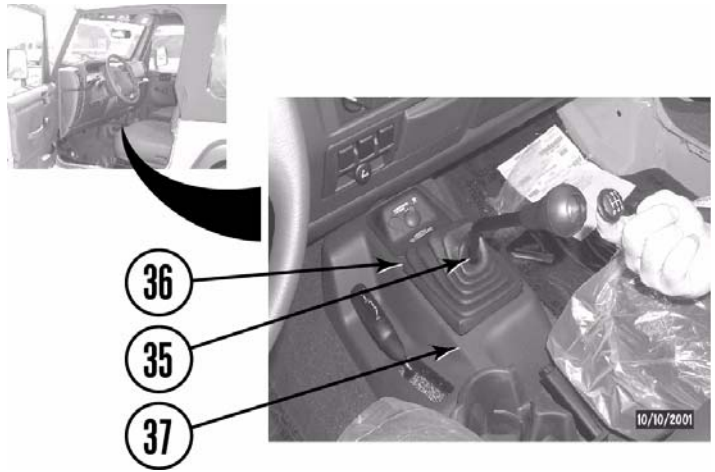

- d. Remove cup holder (38) from shift lever console (37).



- e. Remove two screws (39) from shift lever console (37) and body (40).

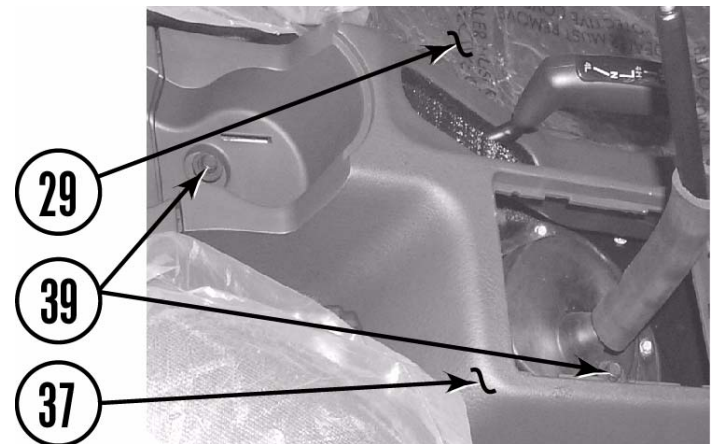

- f. Lift shift lever console (37) and remove four clips (41) and passenger side air bag switch panel (42) from shift lever console.

- g. Remove shift lever console (37) from transmission shift lever assembly (35), 4wd shift lever (43) and vehicle.

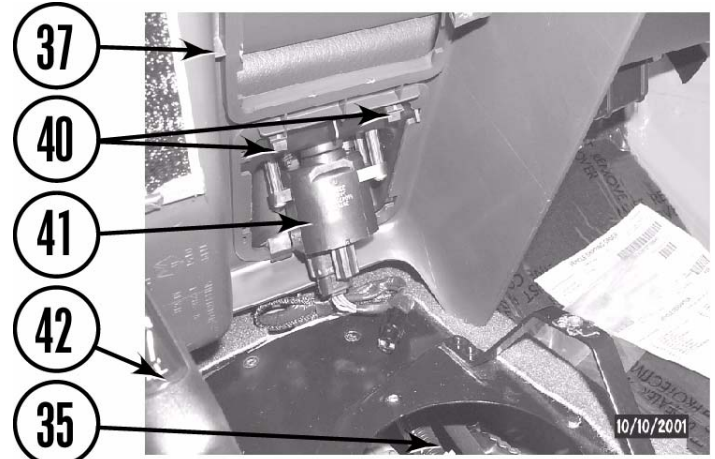

- h. Remove four bolts (44) from inner shift boot (45) and body (40).

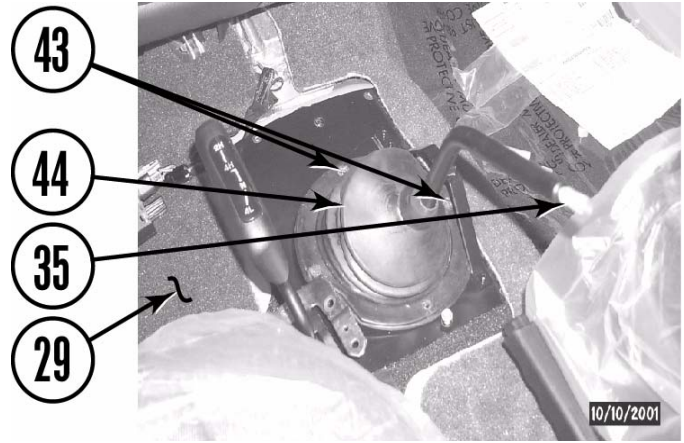

NOTE
 If your jeep is equipped with a 2.5 liter (4 cylinder) engine skip steps B.6.j and B.6.k.

- i. Lift transmission shift lever boot (46) from transmission (47).
- j. (6 cylinder) Remove four screws (48) and transmission spring plate (49) from transmission (47).
- k. Remove transmission shift lever assembly (35) from vehicle.

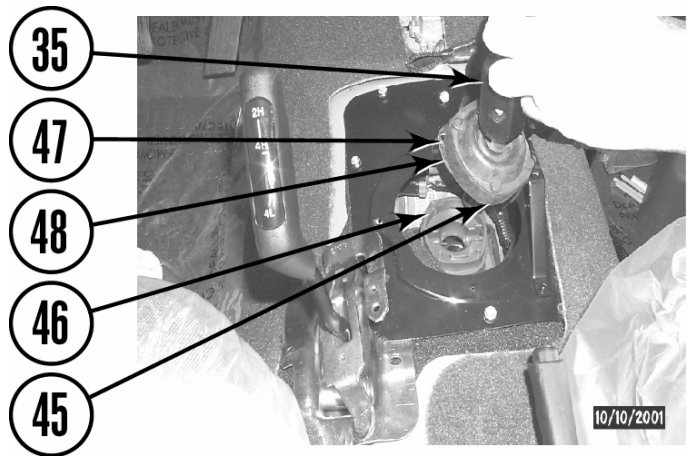

- l. (4 cylinder) Push down on cap (50) and turn counter clockwise to release cap from transmission (47).
- m. Remove boot (46), cap (50), spring (51), and transmission shift lever assembly (35) from transmission (47).

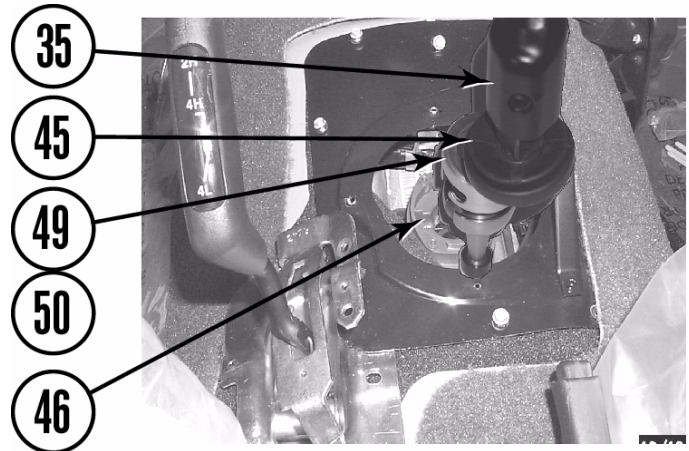

7. Manual 4wd.

- a. Remove two bolts (52) from transfer case shift linkage (53), 4wd shift lever pivot (54) and bracket (55).

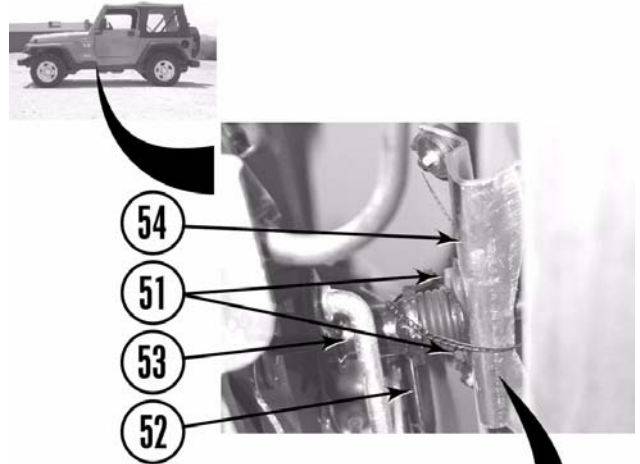

- b. Lift driver side carpet (56) as shown and remove four bolts with captive washers (57) from body (40) and bracket (55).

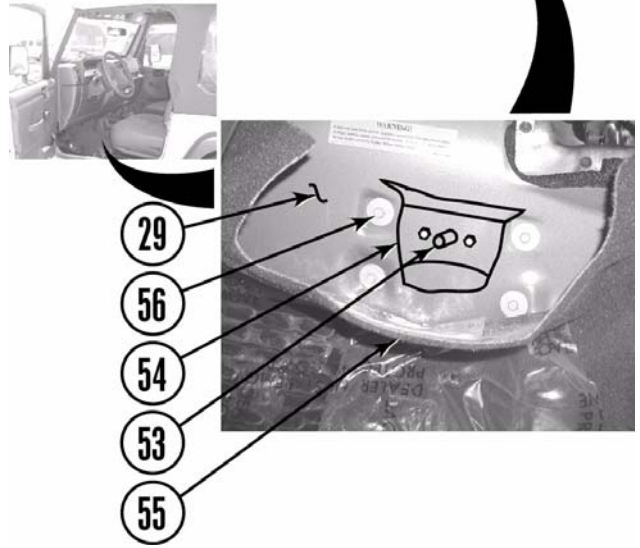

- c. Remove bracket (55) from body (40) and 4wd shift lever pivot (54).

8. Remove fuel filler.

- a. Remove fuel cap (58) from fuel filler assembly (59).

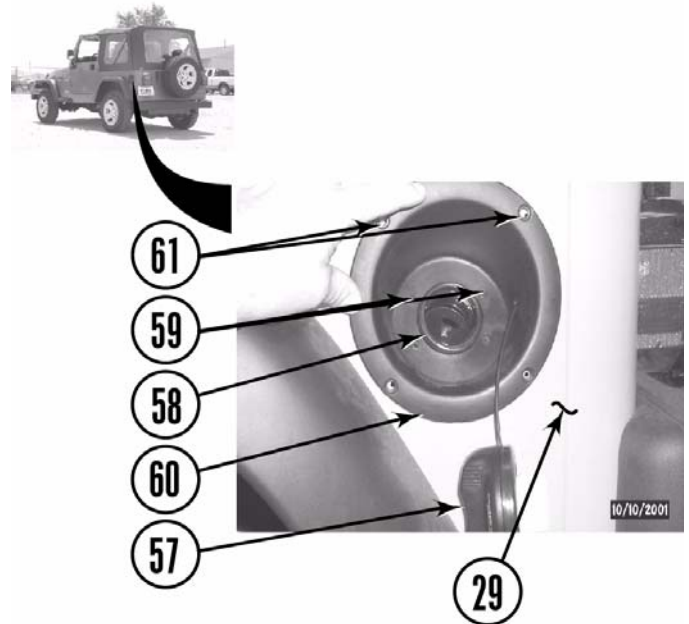

- b. Remove four screws (60) and fuel filler assembly (59) from fuel filler surround (61).

- c. Remove four screws (62) and fuel filler surround (61) from body (40).

C. Install the kit.

1. Prepare to lift body from frame.

⚠WARNING

Failure to replace the OEM cab mounting hardware (except mounting bolts in the *kit*) in the stock locations could result in serious personal injury or damage to the vehicle.

- a. Loosen but do not remove eleven body bolts (63) from core support mounting pad (64) and frame mounting pads (65), core support (15) and body (40).

⚠WARNING

Use extreme caution when lifting body from frame. Ensure lifting device is securely placed. Keep hands out from between frame and body, or serious personal injury could result.

⚠CAUTION

Continually check hoses, wires, lines, etc. to be sure that everything is flexing properly and not binding, or damage to the vehicle could result. Be especially careful of the a/c hoses at the firewall, the belt pulley, and at the core support. Ensure brake lines stretch while lifting. Bending the lines to gain ample slack may be necessary. Be extremely careful not to kink the lines.

⚠NOTE

Ensure stock spacers and cab mounting pads stay on vehicle unless otherwise specified in these instructions. *Kit* spacer blocks are installed in addition to the stock spacers and cab mounting pads.

- b. Remove bolt (63) and lower bushing (66) from core support mounting pad (64).
- c. Remove five bolts (63) and lower bushings (66) from frame mounting pads (65), and body (40) passenger side.

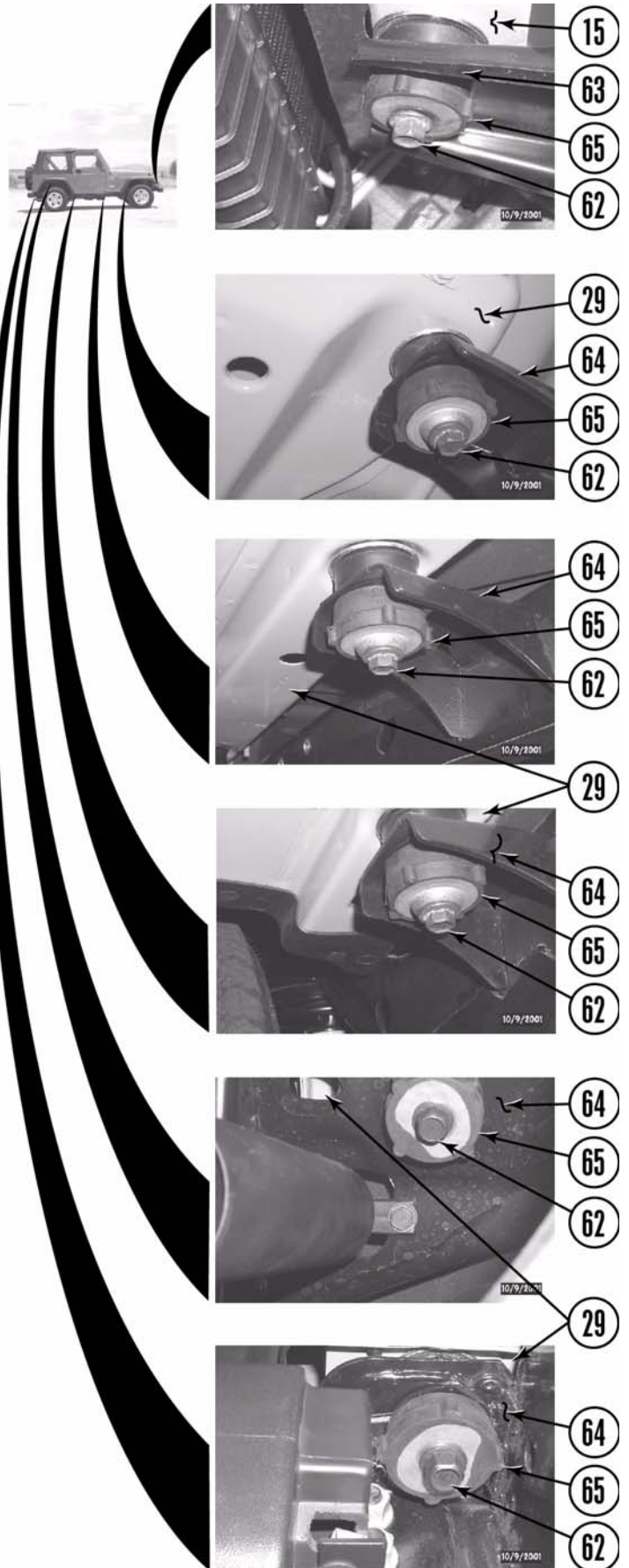

2. Lift body and install passenger side spacer blocks.

NOTE

3" *kit* spacer blocks shown, for clarity. Wait to install *kit* spacer block under the core support until the passenger side of the body is lifted and the driver side of the body is being lifted.

- a. Using a hydraulic jack and a wooden block, slowly lift the body (40) passenger side just high enough to position the five *kit* spacer blocks (67 and 68) between the body and top body bushings (69).
- b. Install *kit* 1/2" x 4 1/2" bolt (70) through *kit* 1/2" SAE washer (71), lower body bushing (66), frame mounting pad (65), top body bushing (69), *kit* 1" x 3" spacer block (67), and body (40).
- c. Install *kit* 1/2" x 4 1/2" bolt (70) through *kit* 1/2" SAE washer (71), lower body bushing (66), frame mounting pad (65), top body bushing (69), *kit* 1" x 2" spacer block (68), and body (40).
- d. Install *kit* 1/2" x 4 1/2" bolt (70) through *kit* 1/2" SAE washer (71), lower body bushing (66), frame mounting pad (65), top body bushing (69), *kit* 1" x 2" spacer block (68), and body (40).
- e. Install *kit* 7/16" x 3 1/2" bolt (72) through *kit* 3/8" USS washer (73), lower body bushing (66), frame mounting pad (65), top body bushing (69), *kit* 1" x 2" spacer block (68), and body (40).

NOTE

Wait to install *kit* 7/16" x 5 1/2" bolt through body bushing, rear bumper, *kit* lift block, and body until the passenger side of the body is lifted and the driver side of the body is being lifted.

- f. Install *kit* 7/16" x 3 1/2" bolt (72) through *kit* 3/8" USS washer (73), lower body bushing (66), frame mounting pad (65), top body bushing (69), *kit* 1" x 2" spacer block (68), and body (40).

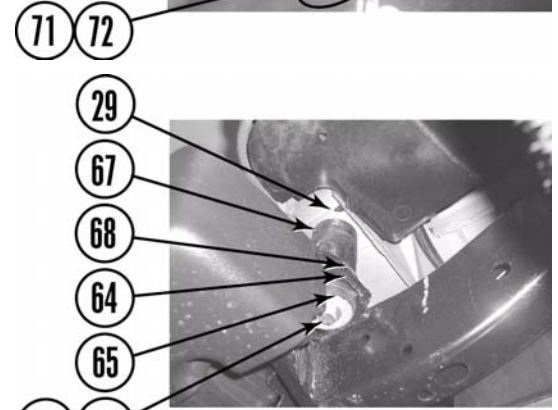
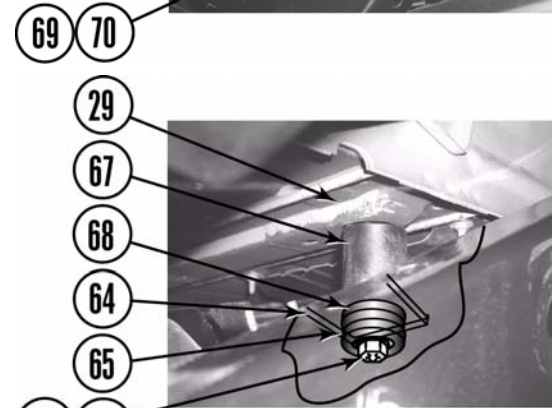
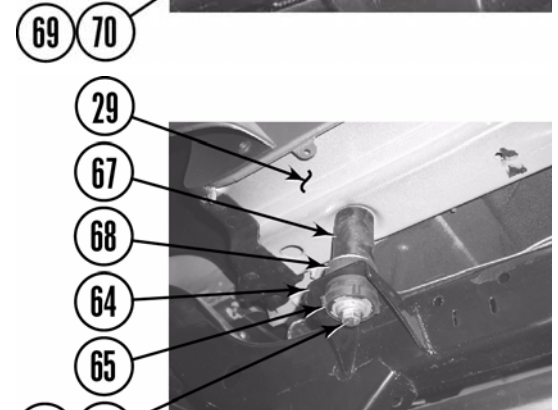
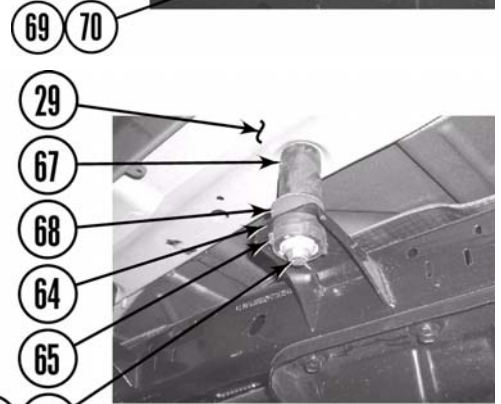
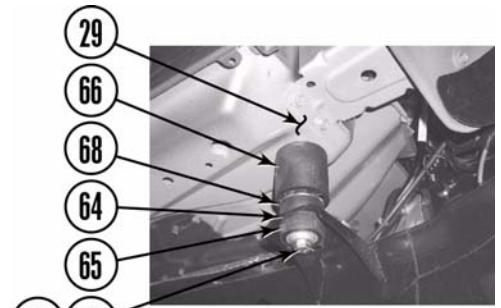

3. Passenger side bump stop / head light bezel.

- a. Remove urethane bumper (74) from core support (15) passenger side.

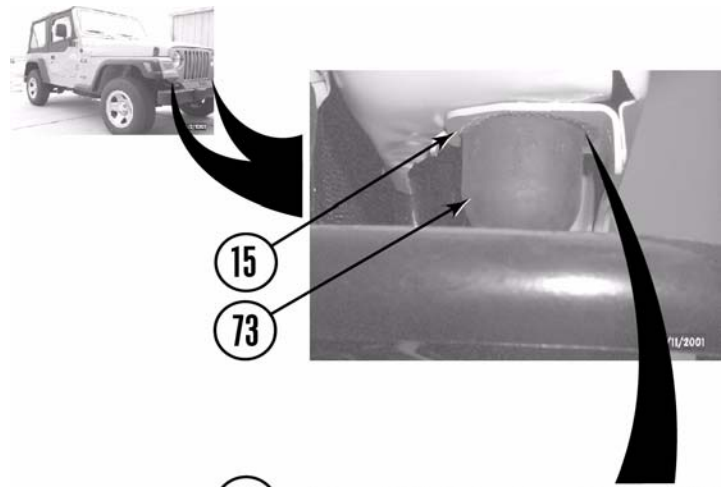

- b. Coat threads of *kit* 5/16" x 3/4" bolt (75) with Loctite.

- c. Install *kit* bump stop (76) on core support (15) with *kit* 5/16" USS washer (78) and *kit* 5/16" x 3/4" bolt (75). Torque to 10 lb-ft. DO NOT over-tighten.

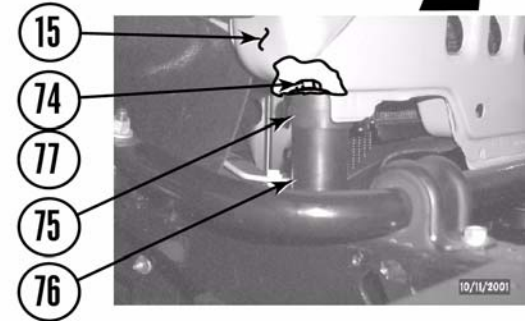

- d. Install head light bezel (14) on core support (15) with three screws (13).

- e. Lower body (40) onto *kit* spacer blocks (67 and 68).

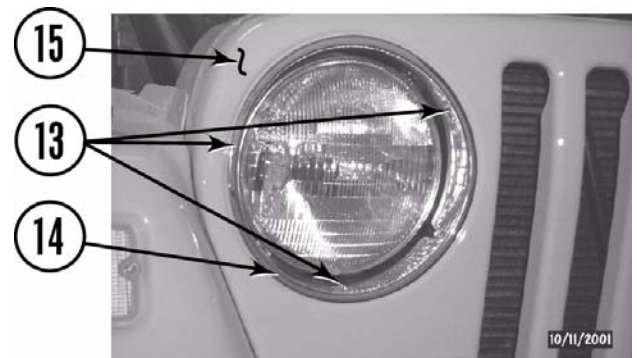

4. Install body driver side spacer blocks.

- a. Repeat steps C.2.a. through C.2.f. for driver side body (40).

- b. Install *kit* 7/16" x 3 1/2" bolt (72) through *kit* 3/8" USS washer (73), lower body bushing (66), core support mounting pad (64), top body bushing (69), *kit* 1" x 2" spacer block (68), and core support (15).

- c. Repeat steps C.3.a. through C.3.e. for driver side core support (15).

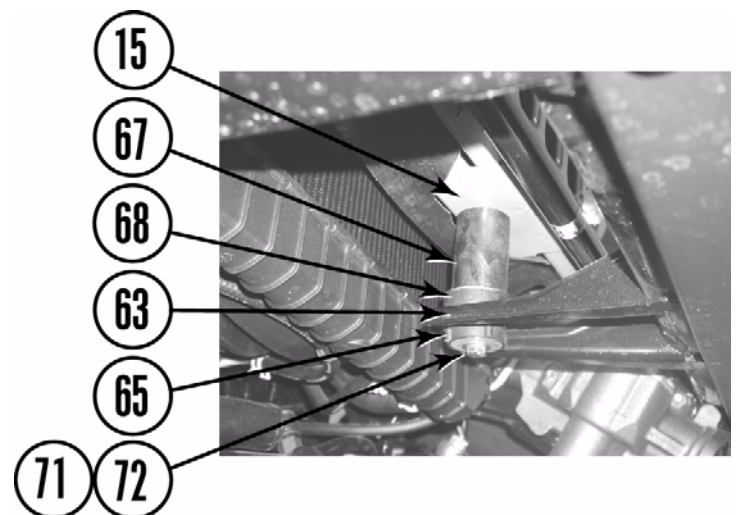

5. Finish 3 spacer block installation.

- a. Remove five *kit* 7/16" x 3 1/2" bolts (72) and six *kit* 1/2" x 4 1/2" bolts (70) one at a time from core support, body, and frame mounting pads (15, 40, and 65), coat threads with Loctite® and reinstall.
- b. Adjust body (40) to frame alignment and tighten bolts (70) to 50 lb-ft and bolts (72) to 35 lb-ft.

6. Fuel filler.

- a. If necessary, adjust rear axle vent line (79), and zip tie (80) down vent line and vent hose (81).

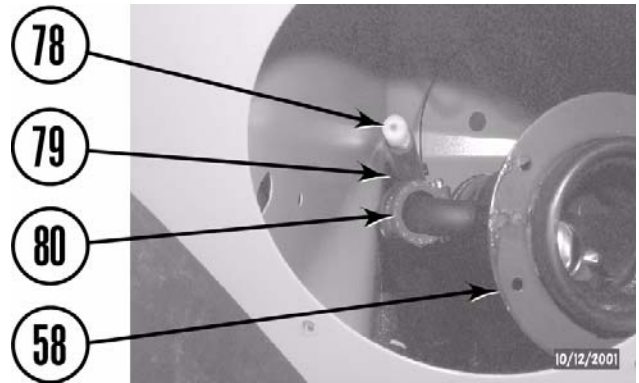

- b. If necessary, adjust two clamps (82 and 83), fuel filler hose (84), vent hose (81), and fuel filler assembly (59) on fuel tank (85) and vehicle.

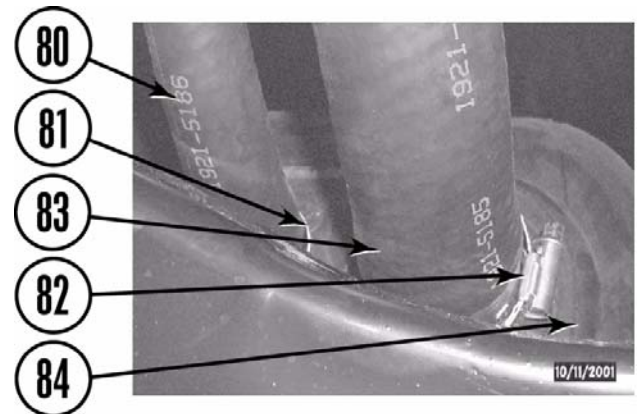

- c. Install fuel filler surround (61) on body (40) with four screws (62).
- d. Install fuel filler assembly (59) on fuel filler surround (61) with four screws (60).
- e. Install fuel cap (58) on fuel filler assembly (59).

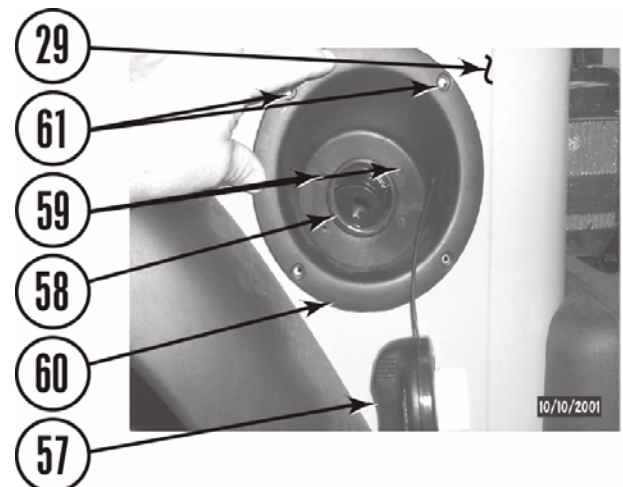

7. Manual 4wd.

- a. Install *kit* transfer case linkage lowering plate (86) on bracket (55) with two bolts (52).
- b. Install 4wd shift lever pivot (54) on *kit* transfer case linkage lowering plate (86) with two *kit* 1/4" x 1" bolts (87), four *kit* 1/4" SAE washers (88), and two *kit* 1/4" nylock nuts (89).
- c. Install bracket (55) on body (40) driver side with four bolts with captive washers (57).
- d. Check 4wd shift lever (43) operation. Ensure there is complete engagement in all ranges. If range or ranges does not engage, shorten or lengthen transfer case shift linkage (53) with adjusting nut (90).
- e. Position carpet (56) on body (40).

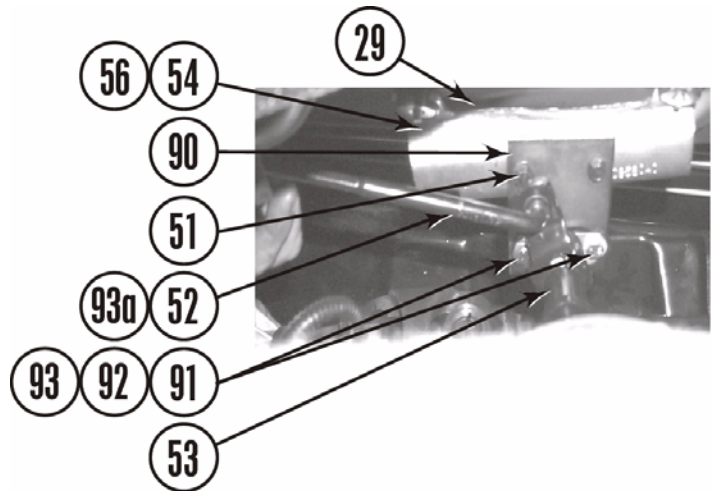

8. Inside cab (manual transmission).

NOTE
If your jeep is equipped with a 2.5 liter (4 cylinder) engine skip steps C.9.e and C.9.g.

- a. Position transmission shift lever assembly (35) on transmission (47).
- b. (6 cylinder) Install transmission spring plate (49) on transmission (47) with four screws (48).
- c. Install transmission shift lever boot (46) on transmission (47).
- d. Check shift lever assembly (35) operation. Ensure there is no interference in between shift lever and body (40). If interference occurs, notch body where necessary.
- e. (4 cylinder) Position transmission shift lever assembly (35), boot (46), cap (50), and spring (51) in transmission (47).
- f. Push down on cap (50) and turn clockwise to lock cap in transmission (47).
- g. Position boot (46) on transmission (47).

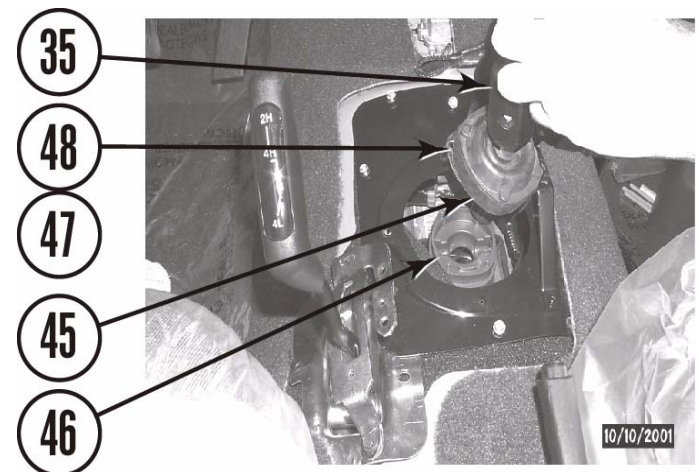
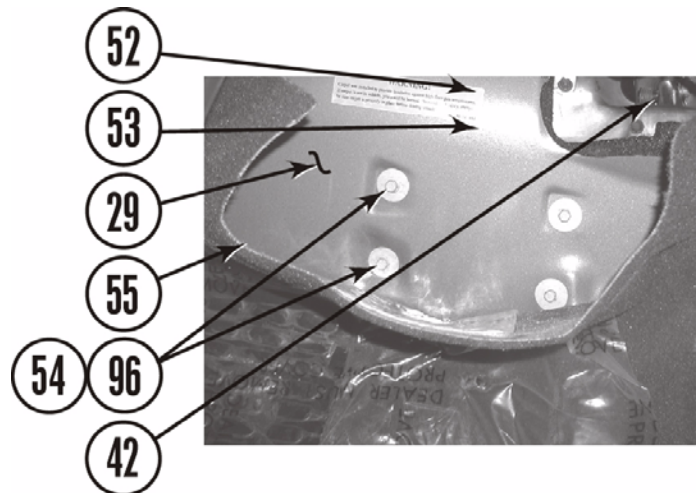

- h. Install inner shift boot (45) on body (40) with four bolts (44).
- i. Check shift lever assembly (35) operation. Ensure there is no interference in between shift lever and body (40). If interference occurs, notch body where necessary.
- j. Position shift lever console (37) on body (40), transmission shift lever assembly (35), and 4wd shift lever (43).
- k. Position passenger side air bag switch panel (42) on shift lever console (37) with four clips (41).
- l. Install shift lever console (37) on body (40) with two screws (39).
- m. Check transmission shift lever assembly (35) operation. Ensure there is complete engagement in all ranges. Ensure there is no interference with shift lever console (37) and/or body (40).
- n. Install shift lever cover (36) on shift lever console (37) and transmission shift lever assembly (35).
- o. Install cup holder (38) on shift lever console (37).
- p. Install transmission shift knob (33) on transmission shift lever assembly (35) with locknut (34).
- q. Install shift pattern display cap (32) on transmission shift knob (33).

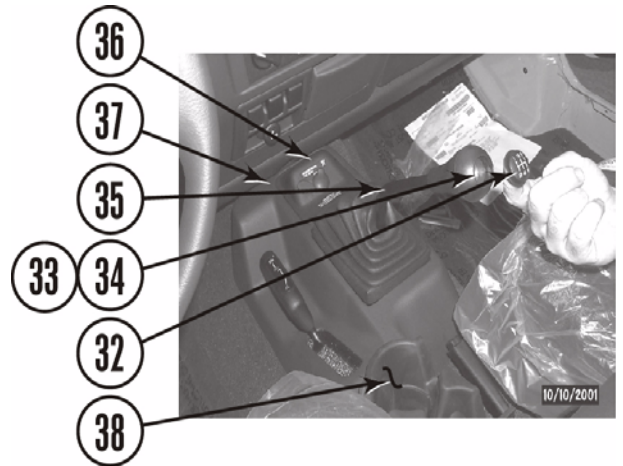
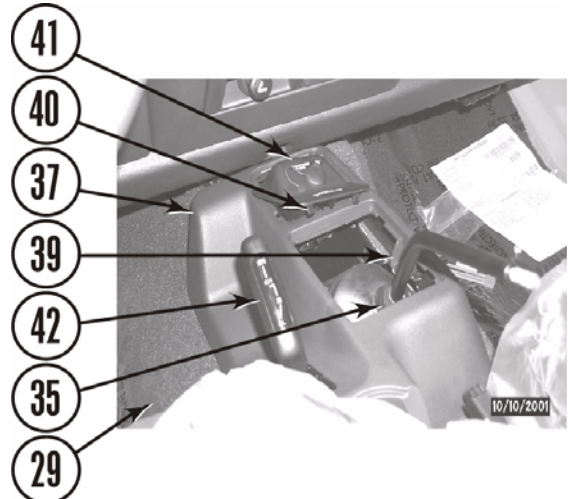
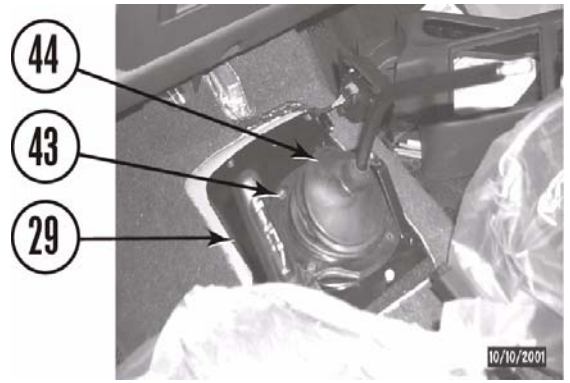

9. Under the hood (steering carrier bearing).

- a. Install steering carrier bearing bracket (31) on frame (11) with two bolts with captive washers (30).
- b. Tighten kit bolts (30) to 25 lb-ft.

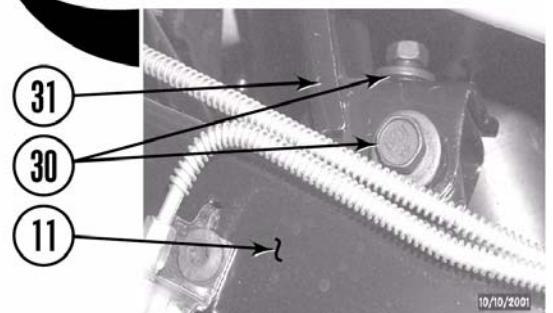

10. Under the hood (air intake).

- a. Install air intake (26) on air filter box (28) and throttle body (29) with two clamps (27).
- b. Install vacuum hose (25) on air intake (26).

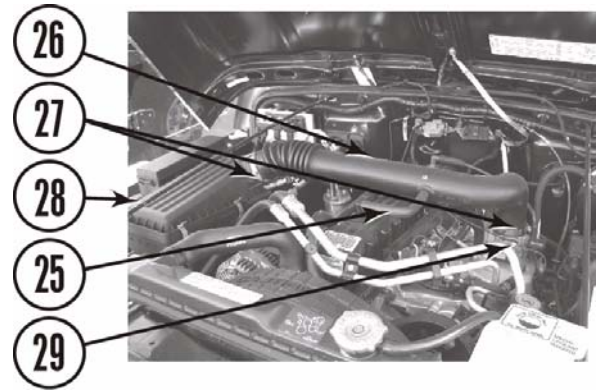

11. Under the hood (radiator).

- a. Install six *kit* radiator brackets (91) on core support (15) with six radiator mounting bolts (24).
- b. Install radiator (22) on six *kit* radiator brackets (91) and core support (15) with six *kit* 1/4" SAE washers (88) and *kit* nylock nuts (89).

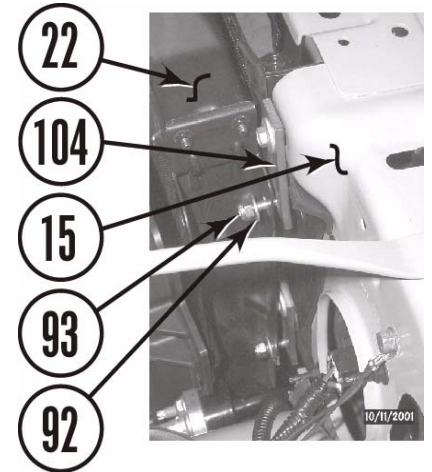

- c. Install fan shroud (21) on radiator (22) with four fan shroud mounting bolts (23).

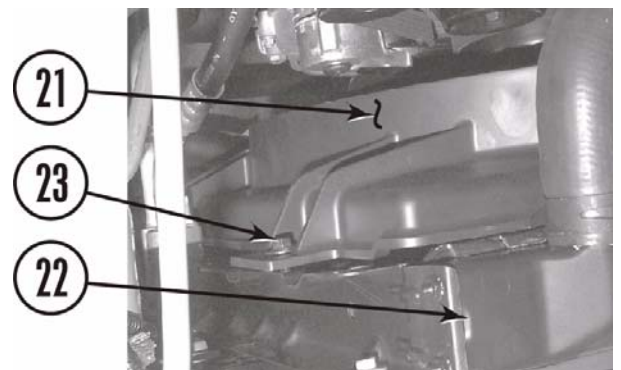

- d. If removed, install overflow hose (19) and overflow bottle (20) on fan shroud (21) and radiator (22).

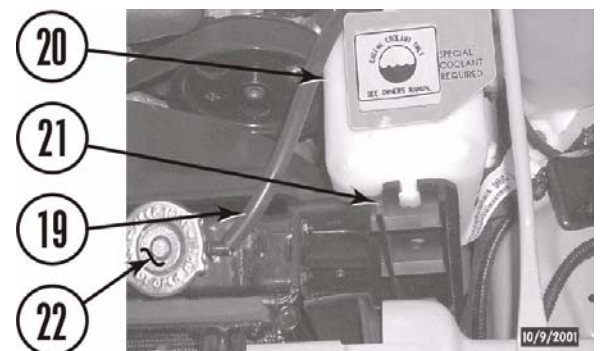

12. Head lights.

- a. If equipped with a second set of headlights on front bumper, secure wiring harnesses (17) to fenders (18) with two *kit* zip ties (92).

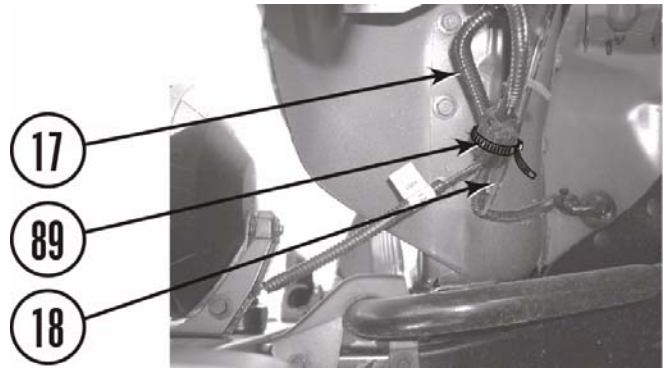

13. Jeep cover front bumper.

- a. Install plastic cover (10) on frame (11) and front bumper (12) with four bolts (9).

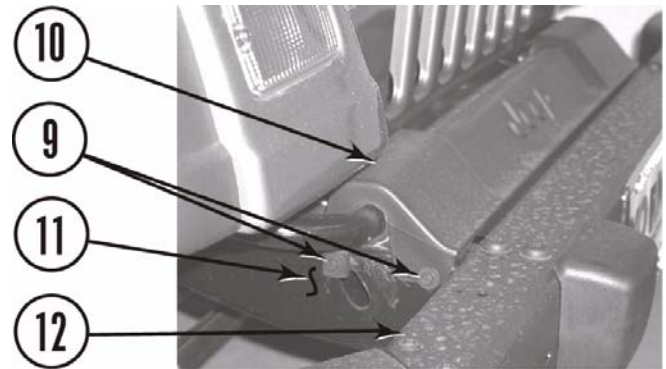

D. After installation is complete.

1. Install airbag fuse (7) in fuse panel (8).
2. Position glove box (4) on dash (6) and connect strap (5).
3. Connect both battery cables to the battery (3). Be sure to reconnect the positive cable (2) first, then the negative cable (1).
4. Install Gap Guards™ in front and rear wheel wells (you did get your gap guards, didn't you?).
5. Stick *kit* warning sticker on the dash in plain sight of all vehicle occupants.
6. Double check the vehicle.

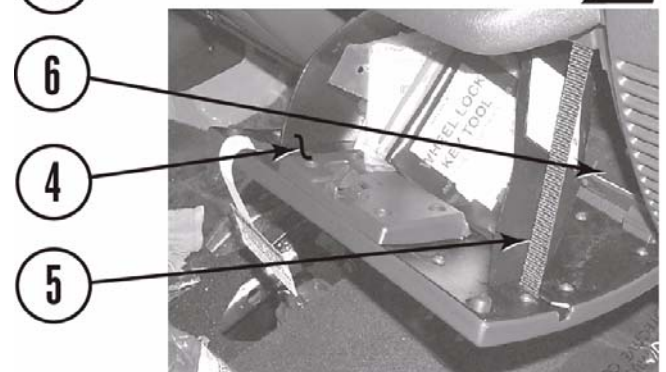
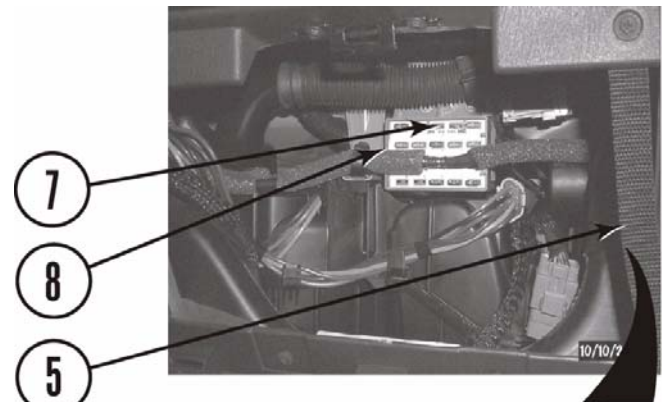

⚠ CAUTION

Retired all fasteners after 500 miles and after off road use. All body lift components should be visually inspected and fasteners re torqued during routine vehicle servicing.

- a. Check all mounting hardware to ensure it is properly tightened.

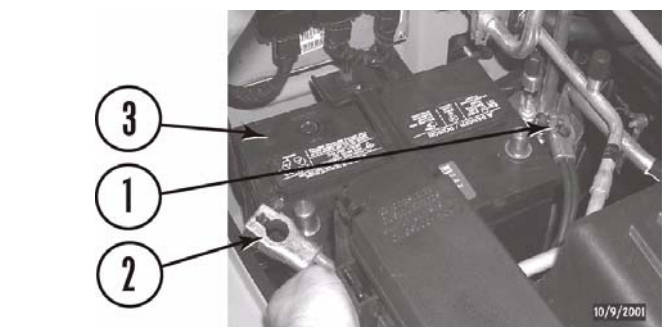

- b. Check all wires, hoses, cables, etc. to ensure they have been properly connected and there is ample slack.
- c. Check vehicle electrical system.
- d. Start vehicle and check the steering in both directions to ensure that there is no bind. Check clutch operation. Check the operation of the brake system and the parking brake. Check both shift levers' operation. Ensure that there is proper engagement in all gears and 4 wheel drive ranges.

⚠CAUTION

Never open a closed cooling system after the vehicle has been started. Only fill the cooling system if the cap has been removed while the vehicle was still cold.

- e. Check coolant level. Fill coolant to the proper level (refer to the Owner's Manual).
- f. Test drive vehicle in all gears and 4 wheel drive ranges. Pay close attention to all vehicle systems. Check all hardware again in 500 miles and as part of your regular maintenance schedule.

⚠CAUTION

Performance Accessories does not recommend any particular wheel and tire combinations for use with its body lifts and cannot assume responsibility for the customer's choice of wheels and tires. Reference your owner's manual for recommended tire sizes and warnings related to the use of oversized tires. Larger wheel and tire combinations increase stress and wear on steering and suspension components, which leads to increased maintenance and higher risk for component failure. Larger wheel and tire combinations also alter speedometer calibration, braking effectiveness, center of gravity, and handling characteristics. Consult with an experienced local off road shop to find what wheel and tire combinations work best with your vehicle.

⚠NOTE

All warranty information, instruction sheets, and other documents regarding the installation of this product must be retained by the vehicle owner. Information contained in the instructions and on the warranty card will be required for any warranty claims. The vehicle owner needs to understand the modifications made to his vehicle and how they affect vehicle handling and performance. Failure to provide the customer with this information can result in damage to the vehicle and severe personal injury.

D. 1" Parts List

Callout	Quantity	Description
(67)	2	1" x 3" Lift blocks
(68)	9	1" x 2" Lift blocks
(76)	2	Bump stops
(90)	1	Trans shift linkage drop plate
(89)	3	Zip tie
	1	6ml bottle Loctite
	1	Warning to driver sticker
	1	Logo sticker
	1	Bolt Pack
(70)	6	1/2" x 13 x 4 1/2" bolts
(72)	5	7/16" x 14 x 3 1/2" bolts
(71)	6	1/2" SAE washers
(73)	5	3/8" USS washers
	1	Hardware Pack
(75)	2	5/16" x 3/4" bolts
(91)	2	1/4" x 1" bolts
(93)	8	1/4" nylock nuts
(77)	2	5/16" USS washers
(92)	10	1/4" SAE washers
(95)	6	Radiator brackets