



ABUSED WORLD WIDE

2121 Blount Road

Pompano Beach, FL 33069

1-(800)-886-8647 • 1-(954)-782-0604

www.milemarker.com

Installation and Operator's Manual:

Electric Winch System:

SEC8 (PN 77-50141)



Table of Contents:

Safety Warnings & Precautions.....	3
Winching Tips & Techniques.....	6
Getting Started:	
Unpacking Your Winch.....	8
Winch Mounting.....	8
Control Box Installation.....	9
Winch Operation.....	11
Maintenance.....	13
Troubleshooting.....	13
Parts Lists.....	14
Warranty.....	15



Safety Warnings

When using this winch, safety precautions should always be followed to reduce the risk of personal injury and damage to the winch.

1) **LEARN TO USE YOUR MILE MARKER WINCH:**

a. After winch has been installed, take some time and practice using it so you will be familiar with ALL OPERATIONS. Periodically check the winch installation to ensure that all bolts are tight.

b. To ensure proper operation, carefully inspect for any damaged parts before operating the winch.

2) **KEEP WINCHING AREA CLEAR:**

Do not allow people to remain in the area during winching operations. Do not step over a taut wire rope or allow anyone else to do so. Due to the possibility of cable failure, direct all personnel to stand clear of any possible pathway. A snapped cable could cause winch failure, injury or death. Keep proper footing and balance at all times. Do not reach over or across the winch and/or pulling cable while the winch is in operation.

3) **INSPECT WIRE ROPE AND EQUIPMENT FREQUENTLY:**

The wire rope should be inspected for damage that could reduce its breaking strength. A frayed rope with broken strands should be replaced immediately. Always replace the rope with a rope that is rated to sustain any load that the winch is capable of pulling. Any substitute must be IDENTICAL in strength, quality, lay and stranding to the Mile Marker cable originally supplied.

4) **WORKING AREA CONDITIONS:**

Keep the working area well lit. Do not use this winch in the presence of flammable gases or liquids.

5) **KEEP CHILDREN AWAY:**

Keep children away from working area. Never let children operate the winch.

6) **DRESS PROPERLY:**

Do not wear loose clothing or jewelry as they can be caught in moving parts. Protective, electrically non-conductive clothes and non-skid footwear is the only type of clothing you should be using when operating the winch. Wear restrictive hair covering to contain long hair.

7) **USE LEATHER GLOVES:**

When handling or rewinding wire rope always use hand protection to eliminate the possibility of cuts caused by burrs & slivers from broken strands.

8) **DRUM ROPE:**

Always make sure that there are at least 5 complete turns of rope left on the drum before winching.

9) **KEEP HANDS AND FINGERS CLEAR OF WIRE ROPE AND HOOK WHEN OPERATING WINCH:**

Never put your finger through the hook when reeling in the last few feet. If your finger should become trapped in the hook or rope, you could lose your finger. Never guide a wire rope under tension onto the drum with your hand.

10) **NEVER HOOK THE ROPE BACK ONTO ITSELF:**

Hooking the rope back onto itself creates an excessive strain that could break individual strands; this, in effect, weakens the entire wire rope.

11) **KEEP PULLING DURATIONS AS SHORT AS POSSIBLE:**

The winch is designed for intermittent use and cannot be used in constant duty applications. Do not pull more than one minute at or near rated load. If the motor becomes too hot to touch, stop and let it cool off for a few minutes. If the motor stalls, cut off the power immediately.

Safety Warnings-Cont'd

When using this winch, safety precautions should always be followed to reduce the risk of personal injury and damage to the winch.

12) DO NOT OVERLOAD:

For your safety and efficient performance, always use this winch at or under its rated capacity for your safety and for better performance. Do not use inappropriate attachments in an attempt to exceed its rated capacity.

13) AVOID CONTINUOUS PULLS FROM EXTREME ANGLES:

This will cause the rope to pile up at one end of the drum. When possible, please get the rope as straight as possible to the direction of the object.

14) NEVER OPERATE THE WINCH WITHOUT THE ROPE FAIRLEAD FITTED:

Operator injury or winch damage can result if a fairlead is not installed.

15) STAY ALERT:

Watch what you are doing. Use your common sense. Do not use this winch when you are tired, stressed or **WHEN UNDER THE INFLUENCE OF DRUGS, ALCOHOL OR MEDICATION.**

16) DISCONNECT REMOTE CONTROL:

Unplug the winch's remote control when not in use.

17) REPLACEMENT PARTS & ACCESSORIES:

When servicing, use only identical replacement parts. Usage of any other parts will void the warranty. Approved accessories are available from your local distributor.

Precautions

When using this winch, safety precautions should always be followed to reduce the risk of personal injury and damage to the winch.

- 1) Keeps hands and body away from Fairlead (cable intake slot) when operating.
- 2) Secure vehicle in position before using winch.
- 3) Do not exceed winch load weight capacity (see Winch Specifications).
- 4) Be certain winch is properly bolted to a structure (or vehicle) that can hold the winch load.
- 5) Always use proper couplings when connecting winch cable hook to load.
- 6) Do not lift items vertically. The winch was designed for horizontal use only.
- 7) Do not overload the winch (see Model Specifications). It will do the job better at the load it was intended.
- 8) Do not use inappropriate attachments to extend the length of the winch cable.
- 9) NEVER LIFT PEOPLE OR HOIST LOADS OVER PEOPLE.
- 10) Never come in between the winch and the load when operating.
- 11) Do not apply load to winch when cable is fully extended. Keep AT LEAST 5 FULL TURNS of cable on the drum.
- 12) After moving an item with the winch, secure the item. Do not rely on the winch to hold it for an extended period.
- 13) Examine winch before using. Components may be affected by exposure to everyday weathering, chemicals, salts, and rust.
- 14) When loading a boat into a trailer without reel or side hull rollers, make sure the trailer is submerged in the water when the boat is loaded by the winch. Attempting to drag the boat on to the trailer while on land can cause winch failure and possible injury.
- 15) Never operate winch if cable shows any signs of weakening, is knotted or kinked.
- 16) Do not cross over or under the cable while it is in process of loading.
- 17) Do not move vehicle with cable extended and attached to load to pull it. The cable could snap.
- 18) Apply blocks (such as a wheel choke) to vehicle when parked on an incline.
- 19) Re-spool cable properly.

Winching Tips & Techniques

WINCHING TIPS AND USE OF A SNATCH BLOCK

- Use OEM tow hooks, recovery eyes or a clevis mount for attachment of a tow strap or winch cable. Warning: Never use a ball and /or ball mount as an anchor point for tow strap or winch cable. Severe personal injury or death could occur.
- Always heed all winch manufacturer's recommendations, cautions, and warnings.
- Attach return cable to tow hook or recovery eye when using a snatch block. Always use a clevis to secure snatch block to strap, or severe damage could occur to persons and vehicle. (See Figure Below). Caution: Never attach return cable to winch mount. This may overload winch mount

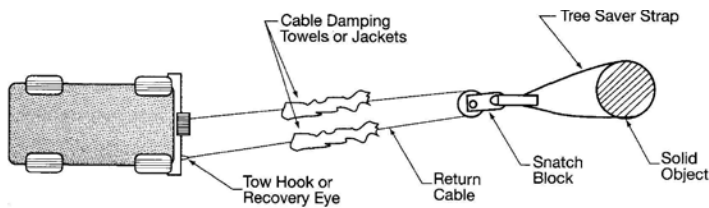

RATING

For maximum line pull rating, winch cable direction must not exceed:

1. 15° angle up or down from horizontal (See Figure Below).
2. 45° angle left or right from straight ahead (See Figure Below). Caution: Exceeding the maximum line pull rating may overload winch, winch mount, and/or front mounted

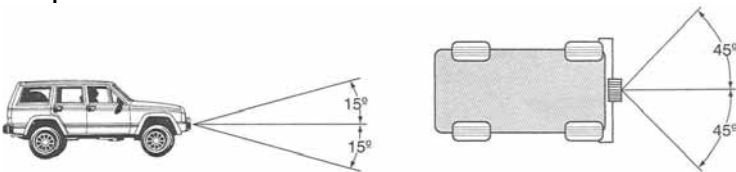

SAFETY TIPS

- NEVER DISENGAGE CLUTCH LEVER WHEN THERE IS A LOAD ON THE WINCH. Mile Marker electric winches utilize an automatic load holding brake, therefore no adjustment to clutch is needed to maintain load.
- Store the remote control cord in a safe place when not in use to prevent use by children or other unauthorized persons who could injure themselves or others or damage the controls.
- Do not operate winch under the influence of drugs, alcohol, or medications.
- Isolate winch before putting hands in or around the fairlead or wire rope drum (The Danger Zone).
- DO NOT OVERLOAD YOUR WINCH. Do not maintain power to the winch if the drum stops. Overloads can damage the vehicle, winch or winch rope and create unstable operating conditions.
- It is recommended to lay a heavy blanket or jacket over the rope about halfway along to the hook attachment. If a rope failure should occur, the weight of the cloth will act as a damper and help prevent the broken rope from whipping (See Figure Below). Remember to move the blanket or jacket as winching proceeds, but halt winching when doing so. Partially raising the hood of the vehicle will also give a measure of protection to its occupants from broken rope or cable, consistent with sufficient forward visibility for the operator.

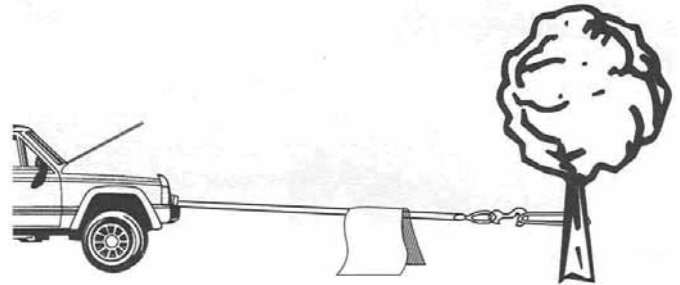

Winching Tips & Techniques

SELF-RECOVERY

1. Always attempt to get the cable as straight as possible to the direction of the vehicle. It is acceptable to start a pull at an angle if it is obvious that the vehicle will turn towards the hook anchoring point. Turning the steering wheel will assist the process. It is recommended that the driver is in the vehicle.
2. Make sure hand brake and foot brake are free and that the transmission is in neutral.
3. When the driver's attempt to regain vehicle traction is successful, he or she should be careful not to overrun the cable and risk the possibility of it being trapped under the vehicle.
4. DO NOT move your vehicle in reverse to assist the winch. The combination of the winch and vehicle pulling together could overload the cable and winch itself.

USE OF A PULLEY BLOCK OR SNATCH BLOCK

Vehicle self-recovery using the pulley block attached to the anchor point for direct pull. In this instance the vehicle becomes the "load" and the actual pulling power on the vehicle will be double at half winch rope speed. Never connect wire rope or hook back to winch mount!

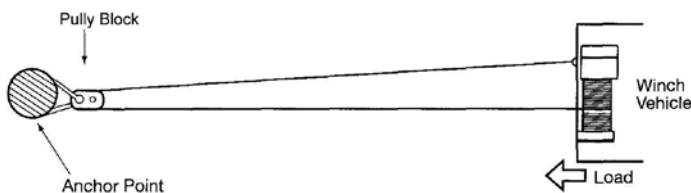

Below: Direct pull on load using the winch vehicles as the anchor with pulley block attached to the load.

The most important aid to successful winching (after the winch) is the pulley block, which can be used to increase the pulling power of the winch or for indirect pulls. Pulley blocks can be used in two modes. First mode is attached to the load and second is secured to an anchor point.

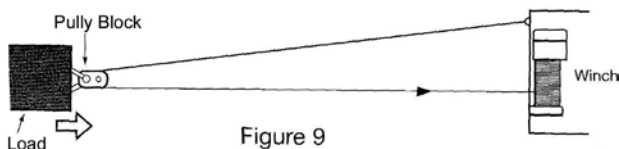

Below: Indirect pull necessitated by obstructions or soft ground. Pulley block attached to load using a suitable anchor point. Note the angled direction taken by the load and subsequent angle of rope feedback on the winch drum (extreme example shown). There may be unavoidable circumstances requiring this mode, though in general it is not recommended unless applied in stages by moving the anchor point or vehicle to avoid the sharp angled rewind on the winch drum. The actual load pulling power and rope speed will depreciate with any increased angle between the ropes.

The anchor point, when used must be secure, using a tree, another vehicle or any firm structure to which a pulley block can be used to your advantage.

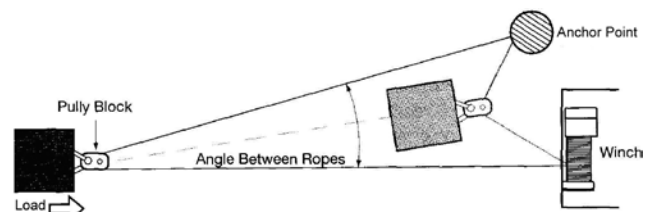

USE OF A NYLON SLING AND SHACKLE

- A shackle should always be used when attaching winch hooks to nylon slings. NOTE: The shackle must pass through both eyes of the sling. The safe working load of the nylon sling is based on the use of both eye ends. Never use the cable or hook to connect directly to the nylon sling.

USE OF GLOVES

- When handling or rewinding the cable always use gloves to eliminate the possibility of cuts caused by burrs and broken strands. Inspect cable and equipment frequently. The cable should be replaced immediately if any sign of burrs or broken strands are evident. A frayed cable with broken strands should be replaced immediately. Always replace the cable with a Mile Marker recommended replacement part. Any substitution must be IDENTICAL in strength, quality, lay and stranding. Never hook the cable back onto itself. Hooking the cable back onto itself creates an unacceptable strain, breaking individual strands which in turn weakens the entire cable. Use a sling. Avoid continuous pulls from extreme angles as this causes cable to pile up at one end of the drum.

Getting Started

Unpacking Your Winch

•Unpack your new Mile Marker winch and ensure that all the parts are included by referring to parts list and exploded view drawings provided in this manual.

NOTE: If you find any missing or broken parts, please call Mile Marker as soon as possible at the number present on the cover page of this manual.

Clocking Instructions

Winch gear housing can be clocked in 12 ways enabling the user to position the clutch lever at 12 equidistant locations (0°, 30°, 60°...360°). Undo the 11 bolts (item # 33, M5x58) on the gear housing. Rotate the gear housing to any one of the above position so that all holes align. Secure the gear side housing to the winch leg by the 11 bolts (item # 33, M5x58) that were earlier removed.

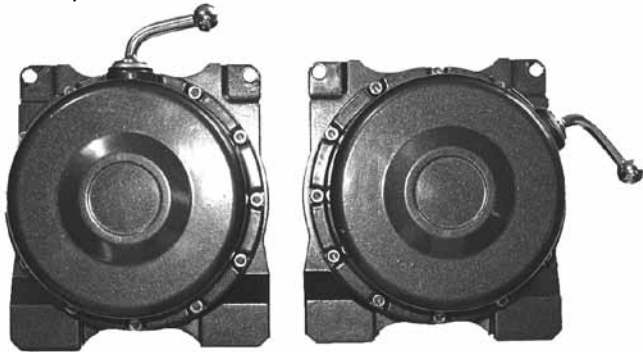

Clocking Positions: 0° and 60°

Winch Mounting

NOTE: Mile Marker recommends the use of its mounting systems for proper winch installation and optimum winch performance. However, when not using Mile Marker Mounting System, ensure that the mounting platform is strong enough to meet the maximum rated load of the winch in use. Mile Marker recommends steel plates with thickness of at least 0.25".

Your Winch should be aligned and secured to a solid part of the vehicle (front or rear) where the full rated load will be evenly distributed.

CAUTION: It is essential that the mounting surface be flat and the winch is mounted such that the three major sections (Gear housing end, drum and motor end) are in proper alignment.

1. Drill four mounting holes (10mm in Dia.), if necessary, according to the bolt pattern mentioned in the winch specifications.
2. Fasten the winch body to the mounting platform using the four Capscrews (M10 X 34mm) and Nuts (M10) provided.
3. Torque the Capscrews to about 35 ft-lb (47.5 N-m).
4. All Mile Marker Mounting Systems come predrilled with fairlead holes. If you are using any other mounting platforms, drill two holes for the roller fairlead installation. Position the holes such that the fairlead opening hole stretches from the circumference of the drum to the end of the maximum permissible layers on the drum in the direction cable is being rolled.

CAUTION: When replacing the capscrews or when longer bolts are required, make sure that you use bolts of Grade 5 or greater.

Control Box Installation



2-1: Control Box and Tools Needed: 14mm & 10mm Wrench, Metric Allen Wrench Set



2-2: Install the mounting bracket to the bottom of the control box with a 10mm wrench.

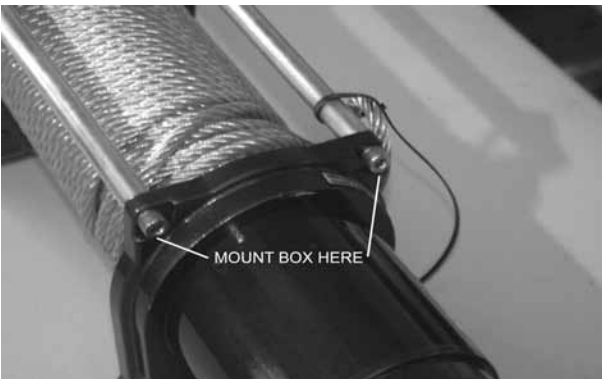

2-3: Control Box Mounting Points

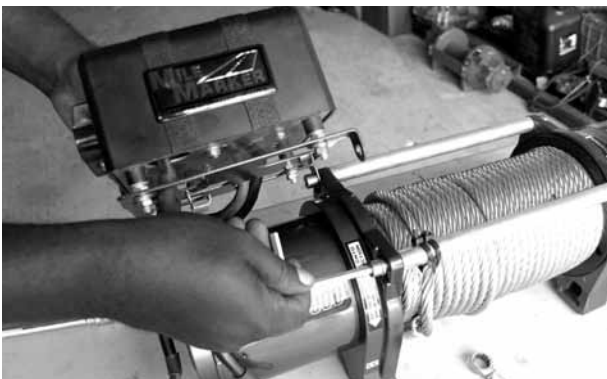

2-4: Front Control Box Mounting Point with Screw

NOTE: Your Mile Marker Control Box can either be mounted to the winch or in a remote location. However, Mile Marker recommends you to mount it to the winch following the instructions below. If you choose to mount it in a remote location, please ensure that: (a) the location does not interfere with any vehicle's moving / functioning parts, and (b) you use electrical cables with similar or better specifications as that provided by Mile Marker.

CAUTION: Make sure that all exposed electrical connections are covered with insulation boots to avoid electrical short.

Battery cables should not be drawn taut; leave some slack for cable movement. Also, ensure that they are routed properly with out any interference with the vehicular components that could potentially damage the cable or cause electrical short.

Long battery cable runs may have significant voltage drops that may cause the winch motor controller to not operate.

SEC Series Control Box Installation

You will need a 14mm wrench, 10mm wrench, a metric Allen wrench set and a pair of snips. Also you will need general hand tools for mounting the winch.

1. Unpack the control box (fig. 2-1).
2. Mount the control box to mounting bracket using 10 mm wrench (fig 2-2).
3. Mount the motor control box to the motor die casting and tie bars (fig. 2-3 & 2-4) by removing the tie bar bolts on the winch body, ensuring that one of the bolts is secure at all times.
4. Further secure the bracket to the motor using the provided tie-wrap and trim excess (Fig. 2-5 & 2-6).
5. Slips the boots onto pertinent cables and make electrical connection in accordance with the schematic on following page. Slide the boots onto all the electrical connections made (figs. 2-7 through 2-9).
6. Run battery power cables carefully under hood of vehicle, avoiding interference with moving parts and abrasion points which could potentially cause electrical short.

Control Box Installation Cont'd

7. Attach Black Cable to Negative Battery Terminal (-), followed by Red Cable to Positive Battery Terminal (+) (fig. 2-14). Refer to Winch Operation Section of this manual for proper functioning; if drum rotates in the incorrect direction when "IN" button is pressed, green and yellow motor cables need to be switched.



2-5: Attach Tie Wrap

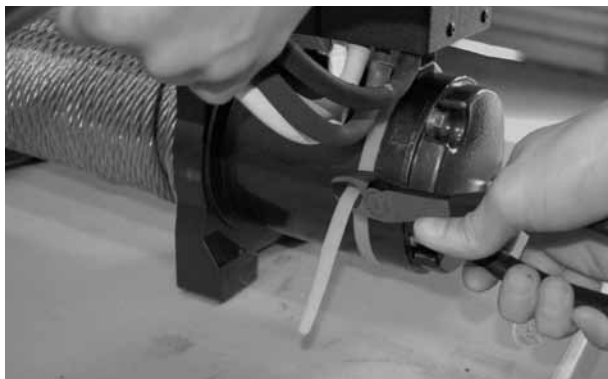

2-6: Clip Excess Length

CAUTION: Do Not Connect Cables to Battery until unit is completely wired to control box and installed on vehicle. Reserve for last step of installation.



2-7: Complete Wiring Schematic: SEC8

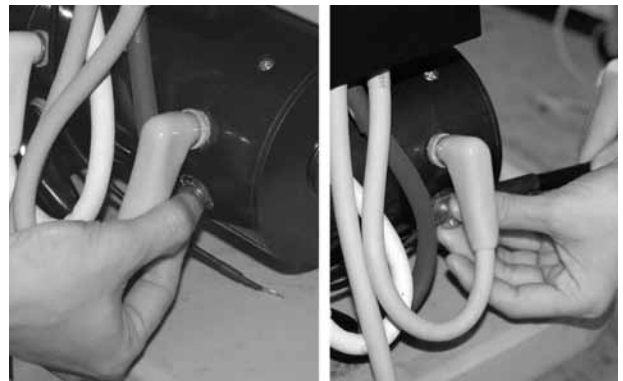

2-8: Black Cables (ground): Remove bolt, Attach both large and small cables, and return bolt to motor.

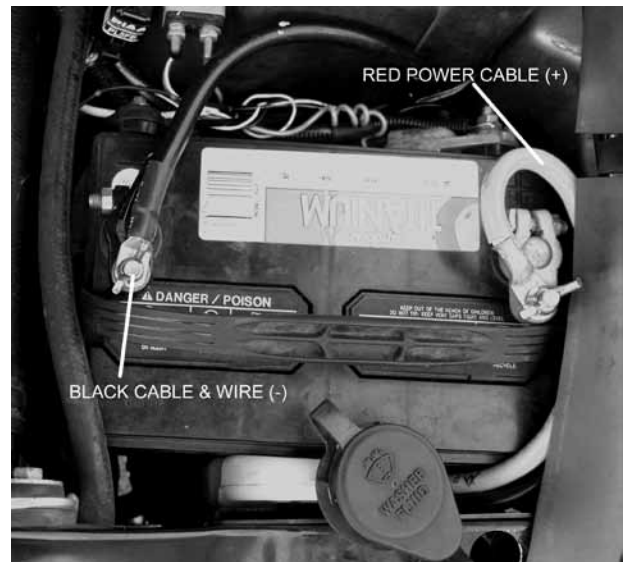

2-9: Complete Wiring to Battery

Winch Operation:

NOTE: For optimal winch performance, it is recommended that you use a fully charged 12V battery with at least 650 Cold Cranking Amperes. Further, it is advised to keep the engine running during the winch operation, so that the battery is being charged continuously.

All Mile Marker winches are equipped with a Clutch Lever that engages / disengages the clutch. Clutch, when engaged, will couple the gear train with winch drum; this is also known as Locking of the winch. The Clutch, when disengaged, de-couples the gear train from the winch drum enabling the drum to rotate independently; this is also called Freespooling the winch.

CAUTION: Before you start using your new Mile Marker winch, you will have to re-wind the entire cable on the drum under a load of at least 500 lbs (227 Kg) starting with at least 5 wraps on the initial layer. Failure to do so will result in the outer wraps pressing against the inner wraps resulting in the damage of the cable.

Always have at least 5 wraps of cable on the winch drum before winching.

Always ensure that the clutch is fully engaged or fully disengaged to avoid any injuries and damages.

All electric winches are for intermittent use only. Never run the winch for more than 1 min at maximum rated load. Wait until the motor cools down before resuming winching operation. Usage of a snatch block is recommended to reduce the load on the winch motor.

All Mile Marker Electric Winches feature an Automatic Load Holding brake; so never run the winch against the brake (OUT on the hand control) for more than 10 seconds. Failure to do so might result in damage to the brake and motor.

Always stay clear of the loaded winch cable.

DISENGAGED



ENGAGED



3-1: Clutch Engagement: SEC/PEC Models

Operational Instructions

1. Disengage the clutch by moving the Clutch Lever to Disengage Position (or Freespool mode) (Fig. 3-1).
2. Free Spool the cable and connect to the desired anchor point (self recovery) or vehicle being recovered.
3. Fully Engage the clutch by moving the Clutch Lever to Engage Position (Fig. 3-1).
4. Lift the protective boot covering the hand control plug-in. Insert the hand control plug.
5. Rotate the red Kill Switch from the "OFF" position, to the "ON" position. (Figs. 3-2 & 3-3).
6. Start winching IN (Figs. 3-4) to remove the slack on the cable, ensuring that the cable is winding onto the drum properly (with out any overlapping or gaps). Never disengage the clutch while the cable is under load!
7. When finished winching, let off the load by winching OUT. With adequate slack created, unhook the cable and re-wind the cable onto the drum.
8. Turn Red Kill Switch back to the "OFF" position. Unplug the hand control and push the protective boot cover back on to the Plug-in.

Winch Operation, Cont'd



3-2: Power OFF



3-3: Power ON

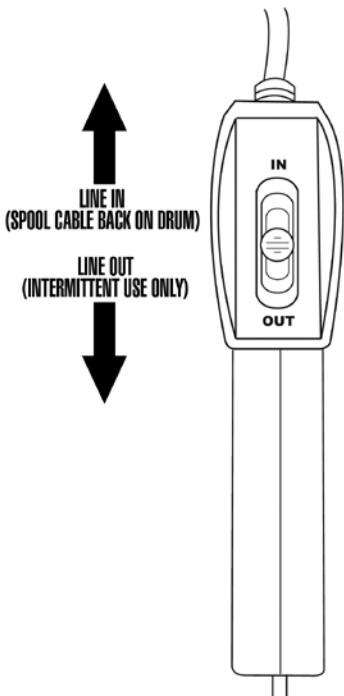

3-4: Remote Control Function Diagram

Winch Features and Specs: SEC8



Features: Clockable Clutch, Planetary Gear System, Automatic Load Holding Brake, Free Spooling, Power In & Power Out, Low Electric Current, Galvanized Roller Fairlead, Series Wound Motor

Specifications:

Part Number	77-50141
Rated line pull	8,000 LBS (3,629 KG)
Gear Train	3 Stage Planetary
Gear Ratio	152:1
Motor	4.8 HP Series Wound (3.6 KW) 12V DC
Control Pendant	Power In, Power Out
Dimensions (LxWxH)	21.5" X 6.25" X 8.0" (546.1 MM X 158.8 MM X 203.2 MM)
Cable	5/16" x 100' (9,800 nominal) (7.94 MM X 30.5M)
Drum Size:	2.5" (6.4 cm)/9" (23cm)
Net weight	81 lbs. (37 kg)
Bolt Pattern	10" x 4.5" (254MM X 114MM) (4 bolts, 3/8")

Performance:

Line Pull		Line Speed		Motor
lbs.	kgs.	fpm	mpm	amps@12v
0	0	26	7.9	95
2000	907	20	6	175
4000	1814	14	4.3	240
6000	2722	12	3.8	295
8000	3629	10.8	3.3	370

Winch Maintenance

- All moving parts within the Electric Winch have been lubricated using high temperature lithium grease at the factory. No further internal lubrication is required for the life of the winch.
- Lubricate the cable periodically using light penetrating oil.
- Electrical connections may corrode over a period of time due to environmental changes. This may result in reduced performance of the winch or even possible electrical shorting. Hence, always clean the electrical connections before and after using the winch.
- After every use of the winch, inspect the cable for damages such as kinks, broken strands etc. When damaged, replace the cable immediately!

CAUTION: It is recommended that you replace the cable with superior Mile Marker cables. If replacing from other sources, carefully compare for the maximum load capacity of the cable with that mentioned in the Specifications Section of this manual.

Troubleshooting

SYMPTOM	POSSIBLE CAUSE	SUGGESTED REMEDY
Motor does not turn on	Safety switch is OFF	Turn safety switch to ON position.
	Switch Assy not connected properly	Insert Switch Assy firmly to the connector.
	Loose battery cable	Tighten nuts on cable connectors
	Solenoid malfunctioning	Tap solenoid to free contact, applying 12 volts to coil terminal directly. Makes an audible clicking when activating.
	Defective Switch Assembly	Replace Switch Assy.
	Defective motor	Check for voltage at armature port with switch pressed. If voltage is present, replace motor.
	Water has entered motor	Drain and dry. Run in short bursts without load until completely dry.
Motor runs too hot	Long period of operation	Let winch cool down periodically.
Motor runs slowly or without normal power	Battery runs down	Recharge battery by running vehicle's engine.
	Insufficient current or voltage	Clean, tighten or replace the connector.
Motor runs but cable drum does not turn	Clutch not engaged	Ensure lever is completely in "engaged" position. If that does not work, contact qualified technician to check and repair.
Motor runs in one direction only	Defective or stuck solenoid	Tap solenoid to free contacts. Repair or replace solenoid.
	Defective Switch Assy	Replace Switch Assy

Parts Breakdown & Assembly

Item	Quantity	Part Number	Description
1	1	76-50151-06	Solenoid Assembly
2	1	76-50151-31	Mounting Bracket
3	2	--	Spring Washer 6
4	2	--	Flat Washer 6
5	2	76-50140-18	Screw M6x12
6	4	76-50140-27	Bolt M8x25
7	4	76-50140-28	Spring Washer ø8
8	1	76-50151-07	Motor End Bearing Assembly
9	2	76-50140-30	Tie Bar
10	2	76-50140-24	Brake shoe
11	1	76-50151-08	Brake Assembly
12	1	76-50140-20	Spring Pin 3x12
13	1	76-50146-09	Drum
14	1	76-50115-19	Cable Anchor
15	1	76-50140-18	Screw M6x12
16	1	76-50151-15	Seal
17	1	76-50151-38	Seal Cover
18	1	76-50151-39	Clutch Handle
19	1	76-50151-23	Retaining Screw M5x16

Item	Quantity	Part Number	Description
20	1	77-50141-20	Gear Ring-input/intermediate
21	1	77-50141-21	Gear Bushing
22	1	77-50141-22	Gear Input Sun
23	1	77-50141-23	Gear Carrier Assy-Input
24	1	77-50141-24	Gear Carrier-Intermediate
25	2	76-50151-12	Gasket
26	1	77-50141-26	Gear Carrier
27	1	77-50141-27	Gear Ring
28	1	76-50151-29	Washer
29	1	76-50151-33	End Bearing
30	2	76-50151-13	Dry Bearing
31	1	76-50151-11	Gear Ring Housing
32	12	76-50140-35	Spring Washer, Diameter 5mm
33	11	76-50151-10	Bolt M5x58
34	1	WH-10	Roller Fairlead
35	1	19-50010C	Cable Assembly ø7.94mmx30.5m
36	1	19-50042	Hook Strap
37	1	76-50152-32	Plastic Binding Strap
38	1	76-50140-05B	Remote Control

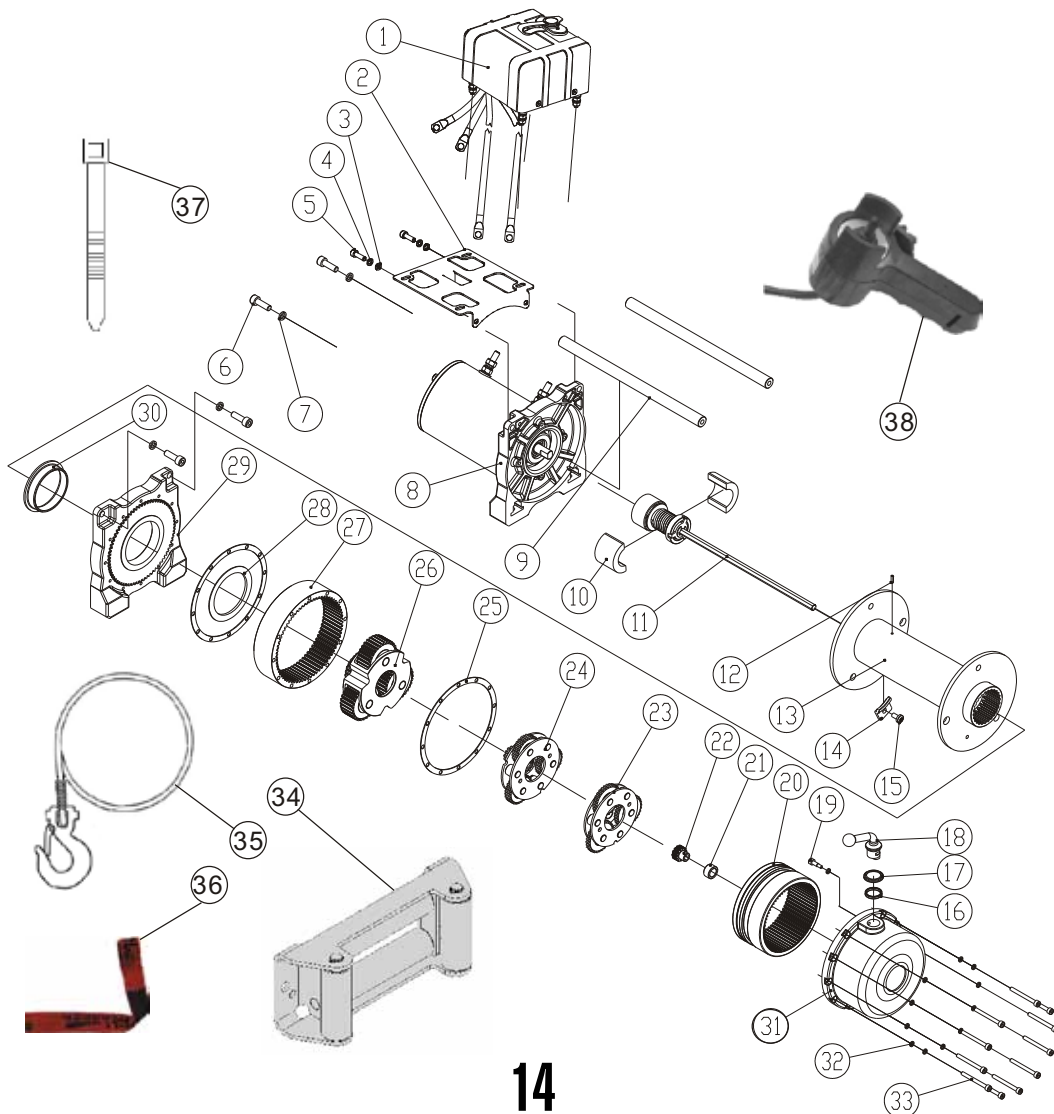

Warranty Information

Limited 2-Year Electric Winch Warranty

Mile Marker, Inc. offers a limited two (2) year warranty to the original retail purchaser for each new Mile Marker electric winch, used as a recreational recovery winch only, against manufacturing defects in workmanship and materials on all mechanical components. Electrical components consisting of motors, solenoids, wiring, wire connectors and associated parts have a limited one (1) year warranty. New cable assemblies are warranted against defects in workmanship and materials when received by the retail purchaser. There is no applicable warranty after initial use. Excluded from this warranty are the finish of the winch and any condition Mile Marker determines to have been caused by misuse or abnormal use. Warranty registration cards for each winch must be submitted at the time of purchase or within 30 days by the end user. Registration cards must reference winch serial number to be valid. Warranty will only be valid for the original purchaser of the winch and installed on the vehicle for which it was originally registered. The owner will be responsible for removing the winch and returning it to Mile Marker freight prepaid unless a determination is made that replacement parts can be sent out which will remedy the problem. Mile Marker will repair or replace any or all winch parts, which after inspection determines to be defective. If the product was purchased in the United States, the owner must contact our warranty department to get a Return Goods Authorization (RGA) Number before returning the product. If the product was purchased outside the United States, the owner must return the product to the original place of purchase.

Mile Marker electric winches are intended for recreational self recovery usage. The warranty is void if the winch is used in commercial or industrial applications.

General Warranty Procedure and Policy:

For U.S. Customers: DO NOT RETURN TO PLACE OF PURCHASE. The end user MUST contact Mile Marker directly by calling 1-800-886-8647. Our customer service representatives will work to resolve any warranty issues. The owner must receive a Return Goods Authorization (RGA) Number before returning any product. The owner will be responsible for removing the product and returning it to Mile Marker freight prepaid unless a determination is made that replacement parts can be sent out which will remedy the problem. Mile Marker will repair or replace any or all parts, which after inspection determines to be defective.

For International Customers: RETURN PRODUCT TO PLACE OF PURCHASE, OR IF NOT FEASIBLE, CONTACT MILE MARKER. The Distributor or Dealer may then repair or replace the product. The dealer may then contact Mile Marker by calling 1-800-886-8647 to receive an RGA number to return merchandise for warranty consideration. If a Distributor or Dealer chooses to submit warranty claims for the end user or Jobber there are certain guidelines that need to be adhered to. They are as follows:

- The merchandise must be within the warranty period. See the Mile Marker warranty statement for time periods.
- Freight must be prepaid to the designated warranty service location.
- Mile Marker will inspect the returned merchandise and make a determination if the problem is warrantable. If it is warrantable Mile Marker will repair and return freight prepaid.

For all returned merchandise: If it is determined that a problem is not warrantable Mile Marker will contact the returning party to determine a disposition of the merchandise as follows:

- Return "as is" without repairing.
- Provide an estimate of the repair costs to the sender for approval/disapproval and take action as directed by the sender.

After receiving the Returns Good Authorization (RGA) Number: Attach the RGA Number, your name, address, phone number and a detailed description of problem relating to malfunction and a copy of a bill of sale. To obtain any warranty coverage, it is absolutely necessary that you present proof of purchase acceptable to Mile Marker, such as a purchase receipt. Please remove the cable from any winch to save both parties on freight costs, and package the product either in its original packaging, or other adequate means of packaging. Mile Marker will not repair or warranty items that are damaged in shipment to us, unless it is no fault of the customer.

Warranty Information cont'd

Limited 2-Year Electric Winch Warranty

Warranty Exclusions:

There are certain conditions that are not eligible for warranty consideration by Mile Marker. They are as follows but not limited to the following:

- Winches returned in pieces will not be considered for warranty.
 - Any item that has been involved in an accident will not qualify for warranty.
 - Winches caked in mud will not qualify for warranty.
 - Winches that have been modified or taken apart and reassembled will not qualify for warranty.
 - Winches that have the tie bars separated from the housing will not qualify for warranty.
 - Winches that show general abuse will not qualify for warranty.
 - Products damaged in shipping due to poor packaging will not qualify for warranty.
-
- Mile Marker will not issue an RGA for products that have been batched. If a Distributor or dealer receives a winch or other item for warranty consideration by Mile Marker, it must have an RGA issued and sent to the designated service location within 15 days of receipt from the end user. Mile Marker will not accept any merchandise without an RGA number or that exceeds the 15 day period. No credits will be provided. Products returned to Mile Marker will be repaired or replaced and returned.

Important Notice: To the fullest extent permitted by applicable law, the following are hereby excluded and disclaimed:

1. All warranties of fitness for a particular purpose;
2. All warranties of merchantability;
3. All claims for the face hereof.

Some states do not allow the above exclusions or disclaimers in consumer transactions and as such this disclaimer/exclusion may not apply to you. To the extent such warranties of fitness or merchantability are deemed to apply to this product, they exist for only so long as the express limited warranty elsewhere set forth is in existence.

The obligation under this warranty, statutory or otherwise, is limited to the replacement or repair at the manufacturer, upon inspection of such part(s), to have been defective in material or workmanship. This warranty does not obligate Mile Marker, Inc. to bear the cost of labor or transportation charges in connection with the replacement or repair of defective parts, nor shall it apply to a product upon which repairs or alterations have been made, unless authorized by the manufacturer, or for equipment misused, neglected or improperly installed.

Mile Marker, Inc. reserves the right to change, alter or improve its products in design, materials or appearance without incurring any obligation to incorporate such changes in products that were previously manufactured.

Consequential Damages: Mile Marker accepts no liability, responsibility or obligations for incidental, indirect or consequential damages from the use of Mile Marker products no matter what the conditions of use. This includes injuries, repair costs, lost time, economic impacts and other similar impacts. Some states do not allow the above exclusions or disclaimers in consumer transactions and as such this disclaimer/exclusion may not apply to you.

This warranty gives you specific legal rights and you may have other legal rights which vary from state to state. To submit a warranty claim contact; Mile Marker, Inc. Warranty Administrator 2121 Blount Road, Pompano Beach , FL 33069 (800) 886-8647

ISO
9001
QUALITY
ASSURANCE
#11940



International
Organization for
Standardization

MILE MARKER^{INCORPORATED}

2121 BLOUNT ROAD
POMPANO BEACH, FL 33069 USA

800.886.8647 TOLL FREE
954.782.0604 USA & INT'L
954.782.0770 FAX

WWW.MILEMARKER.COM
INFO@MILEMARKER.COM

