

QuadraTop® Clearview Windstopper

Installation Manual for '80-'06 Jeep® CJ, YJ & TJ Wrangler Vehicles
#11028.001X and #11028.0135



⚠ WARNING ⚠

Loss of vehicle control involves risk of death or serious injury, particularly to parts of your body not restrained within vehicle. This product is intended for weather protection only and should Not be relied upon to contain occupants in the event of an accident or to protect from either ground contact or falling objects. To reduce risk of accident or injury:

- **ALWAYS WEAR SEATBELTS**
- Always keep head, arms & body parts within vehicle.
- Fully secure or stow the fabric top before driving according to instructions. Never try to adjust the fabric top while driving. Do not use if damaged or worn.
- Read and follow all instructions & warnings accompanying this product, in your vehicle owner's manual and Off Road Driving Supplement.

⚠ CAUTION ⚠

RISK OF EYE INJURY. Safety glasses should be worn at all times while installing or maintaining this product.

PARTS LIST: ALL VERSIONS

FABRIC WINDSTOPPER CURTAIN - QTY 1
SNAP HEAD SCREWS - QTY 3
ACORN LOCKNUTS - QTY 3

FOR 1980-2002 WRANGLER:

#10 x 1/2" OVAL HEAD SCREWS - QTY 4
FOOTMAN LOOP - QTY 2

FOR 2003-2006 TJ WRANGLER:

#8 x 1" PAN HEAD SCREWS - QTY 5
29.5" Z CHANNEL - QTY 1

REQUIRED TOOLS:

SAFETY GLASSES
POWER DRILL AND 1/8" DRILL BIT
PHILLIPS SCREWDRIVER
PENCIL OR CHALK (FOR MARKING)
SILICONE SEALANT
CENTER PUNCH OR UTILITY KNIFE



The Trusted Source

Important Safety Information:

Your QuadraTop® Clearview Windstopper is intended to increase the fair weather enjoyment of your off-road capable vehicle. Before installation, please take a moment to review the

following safety information and installation instructions. Important safety information is generally preceded by one of three signal words indicating the relative risk of injury. The signal words mean:

⚠ WARNING ⚠

a hazardous situation which, if not avoided, could result in death or serious injury. You CAN be KILLED or SERIOUSLY HURT if you don't follow instructions.

⚠ CAUTION ⚠

a hazardous situation which, if not avoided, could result in minor or moderate injury. You CAN be moderately HURT and also may suffer property damage if you don't follow instructions.

NOTICE

Careful attention is required to this instruction or operation but does generally not relate to personal injury. Damage to your Quadratec® product or other property may result if you don't follow instructions.

Before You Begin Installation:

Congratulations on your purchase of the QuadraTop Clearview Windstopper! This high quality roll bar curtain is designed to enhance fair weather driving pleasure while limiting wind buffeting, providing shade and minimal shelter from light rains. We have used only the finest materials in creating this curtain but like any product that is exposed to the elements, there is some general maintenance that is required to keep it looking like new. Please see page 9 for these important maintenance tips.

When unpacking, check to make sure all parts are included. If any part is missing or broken, please call Quadratec Customer Service at 800-745-6037 as soon as possible.

Important: Make sure you become familiar with the installation process of this top by reading the following instruction sheet thoroughly. As you will see, these instructions are broken-out depending on the model year/generation of your Jeep CJ or Wrangler (YJ or TJ) vehicle.



Important: For a smooth fit and ease of installation, this product should be installed at temperatures above 72 degrees. Below this temperature, the fabric may contract an inch or more making it difficult to install. We highly recommend taking the product out of the package and letting it sit inside a warm place or direct sun light for 1-2 hours before you install the top. When warm, this product will install quickly.

It is normal for fabric and soft glass to contract and wrinkle when stored in the shipping carton. In a few days the fabric will relax and wrinkles will disappear. Thank you again for your purchase and let's start the installation process!



The Trusted Source

Clearview Windstopper Installation:

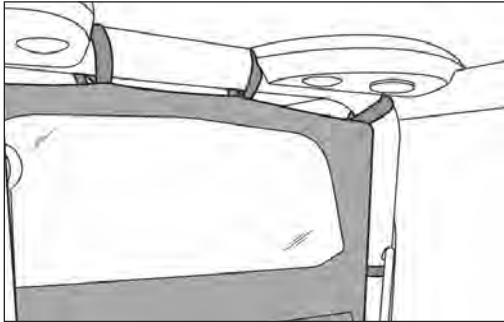

Clearview Windstopper Concept:
The Quadratec Clearview Windstopper cab curtain is ideally designed to attach to the leading edge of a separate Tonno Cover for the rear cargo area. Later steps of this instruction booklet show how to attach the Windstopper to the Tonno. If you need to purchase a Tonno cover, go online to quadratec.com to find the correct application for your particular Jeep Wrangler vehicle.

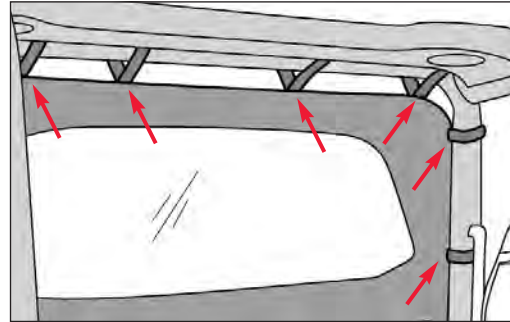

Threading Straps Through Buckles:
Throughout the course of installation, you will need to thread straps through the buckles several times. Please review the diagram for correct strap routing through all buckles.

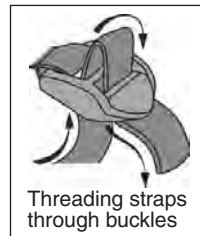

CAUTION

ALWAYS WEAR SAFETY GLASSES DURING INSTALLATION. SOME STEPS FOR SOME VERSIONS REQUIRE DRILLING.

Step One: for ALL Windstopper Versions

REMOVE HARD TOP / FOLD SOFT TOP
Remove any hard top present on your vehicle. If you have a soft top, fold it down before you begin installation. Please follow manufacturer's instructions or guidelines. Store top safely.



CAUTION

BEFORE DRILLING ANY HOLES IN FLOOR AREA, BE SURE TO CHECK FOR WIRING AND/OR FUEL LINES. DO NOT DRILL TOO DEEP. THE DRILL SHOULD ONLY LIGHTLY PENETRATE THE FLOOR METAL AND THEN BE RETRACTED.

NOTICE

AFTER INSTALLATION, DO NOT REMOVE ANY FOOTMAN LOOPS OR Z CHANNEL FROM YOUR VEHICLE. IF FUTURE REMOVAL BECOMES NECESSARY, MAKE SURE ALL SCREW HOLES WILL BE COVERED WITH A SILICONE SEALANT TO MAKE WEATHER TIGHT.



The Trusted Source

Step Two: for 1980-2002 Vehicles only

for '03-'06 TJ, Install skip to page 6

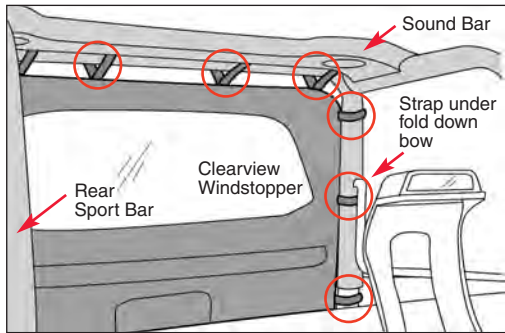

SECURE ALL CENTER/TOP STRAPS
Orient the Clearview Windstopper with the window toward the top and with the vinyl side facing to rear of vehicle.

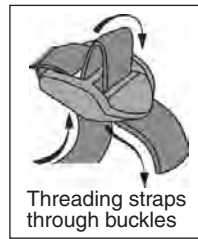

Start at the top and wrap the four top straps around the sport bar, between the sport bar and the Sound Bar, if one is present. Then thread the end of each strap

through each buckle. Loosely tighten each strap to hold the Windstopper in position. Repeat this procedure with the side straps. It may be necessary to lift up slightly on the Fold Down Bow to work the middle strap underneath, in order to wrap it around the sport bar.

NOTICE

IF VEHICLE IS EQUIPPED WITH SOUNDBAR, THE UPPER STRAPS MUST BE INSERTED BETWEEN THE SOUNDBAR AND ROLL BAR PAD.

Step Three: for 1980-2002 Vehicles only

INSTALL FLOOR FOOTMAN LOOPS
Fold the front seats forward and locate the Footman Loop Kit in the parts kit. Center a Footman Loop on the floor of the vehicle below each of the straps sewn to the bottom of the Windstopper. Before drilling, check for wiring or fuel lines underneath the vehicle.

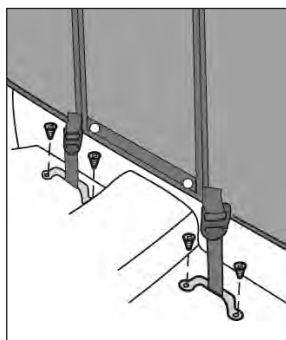
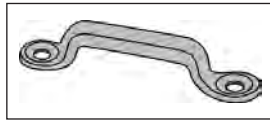

Use the holes in the Footman Loops as guides to mark, center punch and drill four 1/8" holes. Seal the edges of the holes with Silicone Sealer. Install the Footman

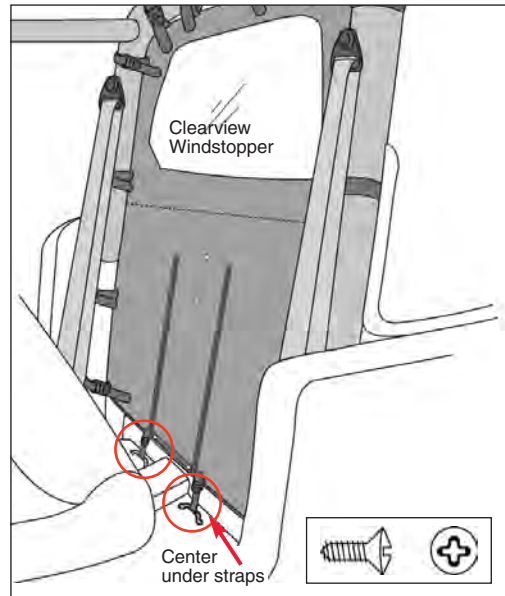

Loops using the four screws from the Footman Loop Kit. We suggest you do not remove footman loops once they are installed, but if you do, be sure to seal all holes with silicone sealer.



The Trusted Source

Step Four: for 1980-2002 Vehicles only

**THREAD BOTTOM STRAPS
THEN TIGHTEN ALL STRAPS**

Gently pull down on the bottom of the Cab Curtain fabric and thread the ends of the straps on the bottom through the Footman Loops and back through the buckles. Tighten all of the straps on the Cab Curtain, top, sides and bottom. Windstopper now in place.

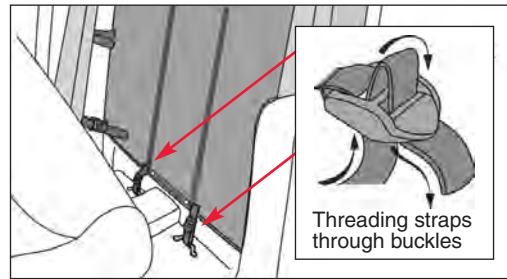

NOTICE Windstopper features 2 sets of snaps on the sewn-on flap for use with our optional Tonno Cargo Cover. The version for '87-'95 YJ uses the upper snaps. The Version for '96-'02 YJ & TJ, uses the lower snaps on the sewn-on flap.

**Optional Steps for use with Tonno
Cargo Cover: for '80-'02 Vehicles only**

**INSTALL SNAPS FOR TONNO ON
WINDSTOPPER FLAP FOR CLOSURE**
Locate the flap sewn to the rear of the Windstopper. Pull the flap out over the top of the front edge of the Tonno Cargo Cover. Pull up on the front, reinforced edge of the Tonno Cargo Cover and mark the locations matching the three snaps on the Windstopper flap, on the material along the top of the Tonno.

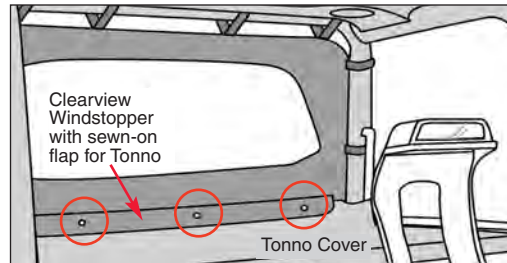

At the marked locations, push the sharp end of a Snap Head Screw through the Cargo Cover from the backing side, to make a hole. Once a hole is formed, pull the screw back out of the hole. Then push the screw through the hole from the vinyl side so that the snap is on top

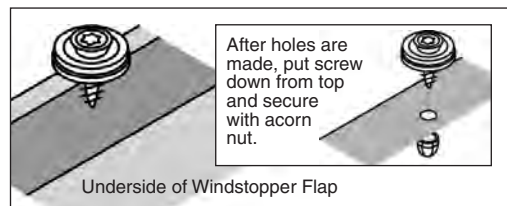

of the vinyl. Thread an Acorn Locknut over the pointed end of the Snap Head Screw. Snap the Tonno Cover and Windstopper together with the three snaps.

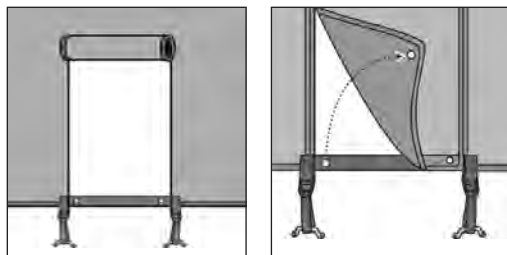

**USING THE WINDSTOPPER
LOWER CENTER FLAP**

To open the center flap in the Cab Curtain, unsnap the flap on each side. Roll the flap up, and snap it to the stud on the vinyl side of the Cab Curtain.

Install complete for '80-'02 Vehicles!



The Trusted Source

Step Two: for 2003-2006 Vehicles only

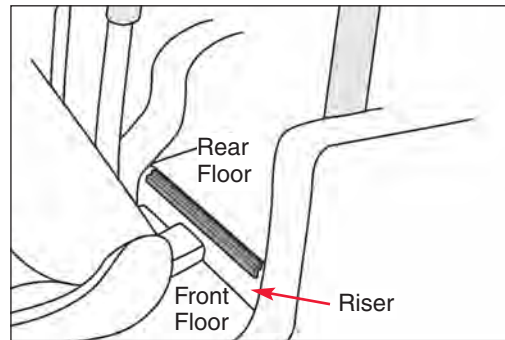
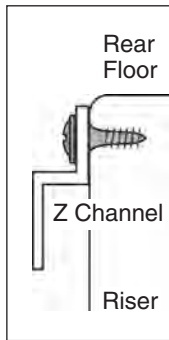
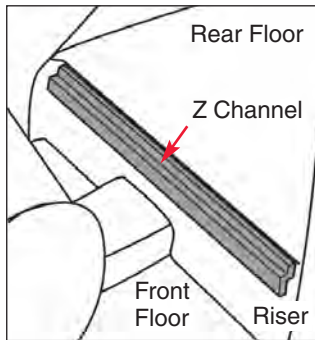

INSTALL "Z" CHANNEL

Fold the front seats forward and locate the "Z" Channel in the parts kit. Orient the channel so that, when installed, the opening will be down. Place the channel on the vertical face of the riser between the front and rear floors, centered in the flat area in the middle of the vehicle. The top edge of the channel should be flush with the top of the riser. Use the holes in the channel as guides to mark, center punch and drill five 1/8" holes. Install the channel using the five #8 x 1" Pan Head Screws from the parts kit.

NOTE:

It is easier to drill holes by either slitting the carpet with a 1/2" "X" shape to access the sheet metal, or center punch through the carpet, remove the carpet and drill the necessary holes - then add smaller slits in the carpet to access the holes for attachment. After drilling the holes for the Z Channel in the floor riser, put silicone sealer on the holes before installing the channel with the screws. If the vehicle is equipped with a factory console, it will be necessary to leave the center screw out of the Z channel.

CAUTION

BEFORE DRILLING ANY HOLES IN FLOOR AREA, BE SURE TO CHECK FOR WIRING AND/OR FUEL LINES. DO NOT DRILL TOO DEEP.

Step Three: for 2003-2006 Vehicles only

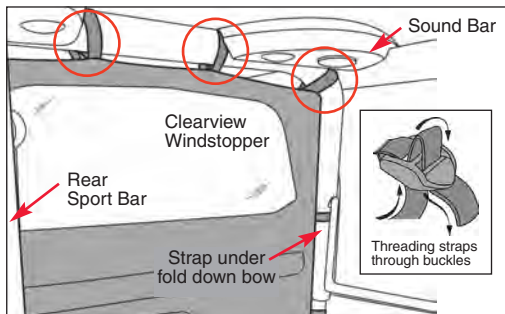

SECURE ALL CENTER/TOP STRAPS
Orient the Clearview Windstopper with

the window toward the top and with the vinyl side facing to rear of vehicle. Start at the top and wrap the four top straps around the sport bar. Then thread the end of each strap through each buckle. Loosely tighten each strap to hold the Windstopper in position. Repeat this procedure with the side straps. It may be necessary to lift up slightly on the Fold Down Bow to work the middle strap underneath, in order to wrap it around the sport bar.



The Trusted Source

Step Four: for 2003-2006 Vehicles only

SECURE THE CLEARVIEW WINDSTOPPER TO Z CHANNEL

Gently pull down on the bottom of the Windstopper fabric and slip the plastic strip sewn on the bottom of the fabric into the Z Channel installed earlier. Once the plastic strip is in place in the Z Channel, fasten the web straps on the door to the fuzzy "loop" strips on either side of the opening. Adjust the plastic strip if necessary. Tighten up all the straps. **The install is complete!**

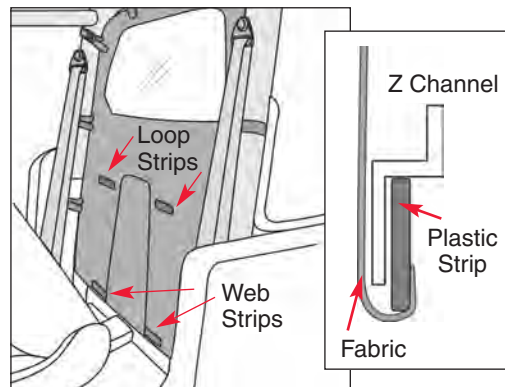

Step Five (optional): for '03-'06 Vehicles only

TO OPEN THE CENTER FLAP

To open the center flap in the Windstopper, pull on the Web "hook" Straps at the bottom of the door to release them from the fuzzy "loop" Strips. Roll the door and fasten the Web Straps to the Loop Strips on each side of the top of the door.

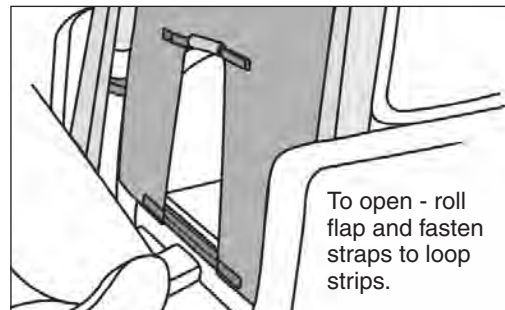

Step Six (optional): for '03-'06 Vehicles only

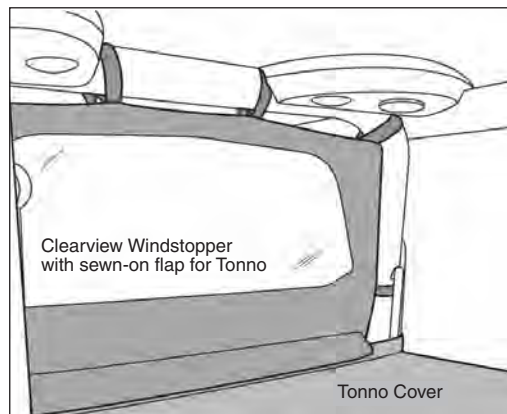

FOR USE WITH OUR OPTIONAL

QUADRATOP TONNO CARGO COVER
To use with the QuadraTop Tonno cover (sold separately @ www.quadratec.com) Locate the flap sewn to the vinyl side of the Clearview Windstopper. Pull the flap out over the top of the front edge of the Tonno Cover.

The final optional steps (see next page) explain how to install 3 snaps for a more secure installation in conjunction with the QuadraTop Tonno Cargo Cover. If you do not choose to use the snaps at this time, we suggest you save them for possible future use.



The Trusted Source

NOTICE

There are two sets of snaps on the Clearview Windstopper. If you have an '03-'06 TJ, use the lower snaps to attach to Tonno Cover.

Step Seven (optional) for use with Tonno Cargo Cover: *for '03-'06 Vehicles*

INSTALL SNAPS FOR TONNO ON WINDSTOPPER FLAP FOR CLOSURE
Locate the flap sewn to the rear of the Windstopper. Pull the flap out over the top of the front edge of the Tonno Cargo Cover. Pull up on the front, reinforced edge of the Tonno Cargo Cover and mark the locations matching the three snaps on the Windstopper flap, on the material along the top of the Tonno.

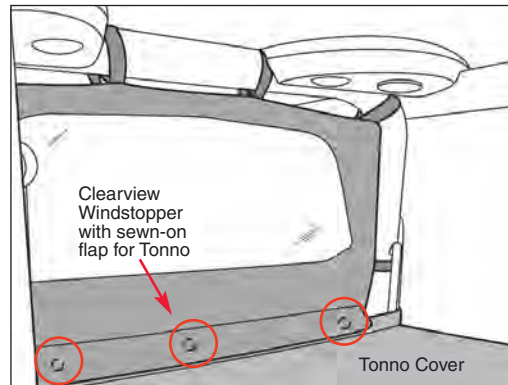

At the marked locations, push the sharp end of a Snap Head Screw through the Cargo Cover from the backing side, to make a hole. Once a hole is formed, pull the screw back out of the hole. Then push the screw through the hole from the vinyl side so that the snap is on top of the vinyl. Thread an Acorn Locknut over the pointed end of the Snap Head Screw. Snap the Tonno Cover and Windstopper together with the three snaps.

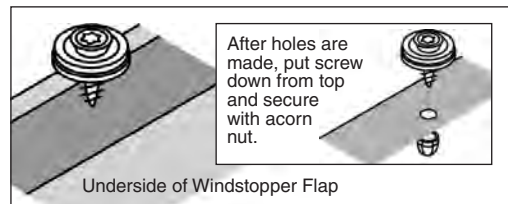

The Trusted Source

Care and Maintenance:

Your QuadraTop accessory is made of the finest materials available but to keep it looking new and for the maximum possible wear, it will need periodic cleaning and basic maintenance. The main threats to your soft top are pollutants, dirt and grime. By keeping your product clean you will prolong its life. We recommend the following to keep your top like new:

Washing: The soft top fabric should be washed often using a mild soap, warm water and a soft bristle brush. You can also use special soft top cleaners available on our website at quadratec.com. Make sure that after cleaning you rinse with clear water to remove all traces of soap to avoid residue.

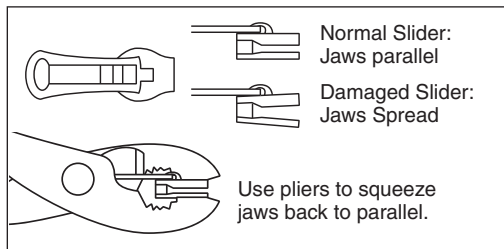

Zippers: Keeping the zipper cleaned and lubricated with a silicone lubricant (available online) will help prevent damage and keep the zippers in a smooth working condition. If zipper opens behind the slider, the slider may have been spread apart. This problem can usually be fixed by using an ordinary pair of pliers to bring the sides back into parallel. Return slider to the end of the zipper in the normal Open position. Squeeze lightly at first and test zipper. If the zipper continues to remain open squeeze more firmly with pliers and try the zipper again. Repeat procedure until your zipper operates correctly.

Windows: It is very important that you keep your QuadraTop windows clean! Use a mild soap and water solution to gently clean your windows. NEVER wipe your windows clean with a dry cloth! Dust and dirt on a dry cloth can scratch your windows causing "fogging" and permanent damage. When removing your windows, store them with a towel between the panels/rear windows to protect them from damage. If frost or ice forms on the outside of your windows during the winter, DO NOT use an ice scraper to remove this frost. Over time you will see small micro scratches in your windows which are natural wear and tear. These Micro scratches can be "polished" out using the window polish available at Quadratec.com.

Water/Fabric: In the event of seeping through the seams, 3M Scotchgard® may be applied on the inside of the seams to stop the leak. Rips in the fabric may be repaired with Bondex® iron on patches. Iron the patches to the Inside of the top, carefully following the Bondex® instructions.

Snaps: Not all models have snaps. If present, keep snaps cleaned and lubricated with silicone to help prevent snaps from sticking to the studs. If a snap does become stuck to a stud, use a screwdriver and GENTLY pry apart to prevent permanent damage to the snap or the top fabric.



The Trusted Source

NEW! QuadraTop®



Key QuadraTop Features

1. Fabric: Tough 23 ounce mildew and UV resistant vinyl coated polyester and cotton fabric provides lasting durability and is backed by a limited three year warranty. QuadraTops are available in factory original colors and textures to keep your Jeep® looking showroom new!

2. Stitching: Our QuadraTop panels are sewn together with marine grade 135 gauge bonded Anefil® polyester thread that's super strong and UV protected. This rot resistant thread will provide years of worry free durability.

3. Seams: All exposed QuadraTop seams feature heat tape seals over double stitching to keep moisture out.

4. Windows: QuadraTops are available with your choice of zip out crystal clear windows or rear and quarter windows with a dark 31% tint keeping interiors much cooler in hot summer months. Our glass panels are 30mil thick and DOT approved for the ultimate in clarity and durability and feature leak proof heat seals. All windows are completely removable for open air enjoyment.

5. Zippers: QuadraTop window zippers are stitched in place like the original tops and feature jam resistant technology and heavy duty plastic teeth. Side quarter windows feature single metal pulls while the rear glass zippers have user friendly double pulls.

6. Hook & Loop Attachment: Our patterns are fully tested to ensure a tight and wrinkle free fit like the originals. All necessary snaps and Heavy Duty Hook & Loop strips are in place to install over the factory bows and there's never any drilling or modifications required!

7. Belt Rail System: Each QuadraTop utilizes the original belt rail attachment methods for a fit that's as tight as a drum!

8. Upper Door Skins: Our fabric upper doors install in just minutes onto your existing factory upper door frames by hook and loop fastener strips. It's quick and easy with our step by step illustrated instructions. Fabric upper doors have double sided weather strip bulb seals and double window zipper pulls. Note: Wranglers with half steel doors only feature clear upper door windows to meet federal and state requirements.

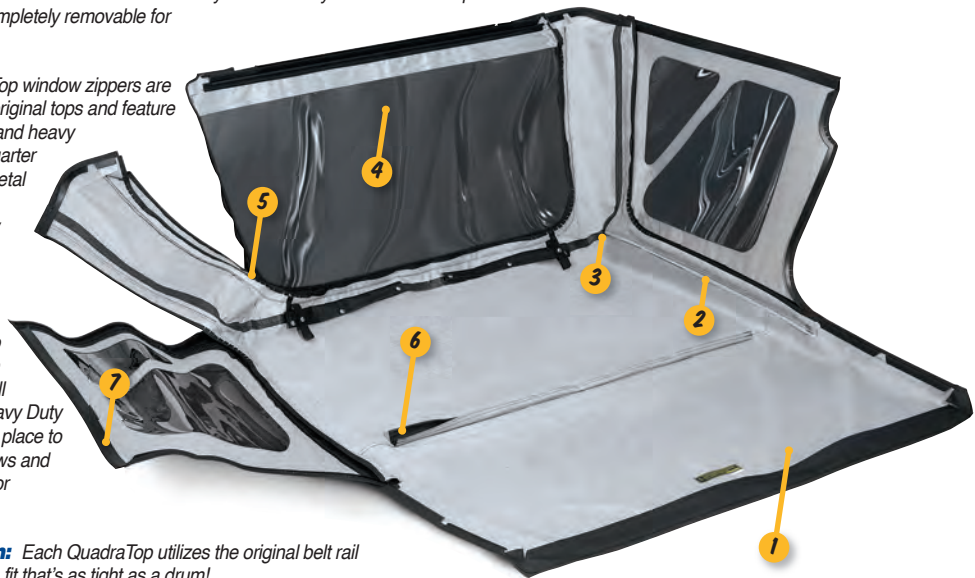

The Trusted Source

QuadraTop® Replacement Soft Tops

Affordable quality and durability with no compromises! Our top kits are designed to work with factory hardware and feature finer quality materials and workmanship along with the latest in manufacturing technologies for unprecedented value. Our new product team with decades of soft top knowledge and experience delivers you all the great features you want in a replacement top with unsurpassed customer service and support. Our QuadraTop is the best value in replacement soft tops compared to other tops costing hundreds more. If for any reason, you are not completely satisfied with your soft top purchase or have an installation question, please contact our professional customer support staff for a solution. All QuadraTops feature a limited Three year warranty against defects. The incredible fit & detailed instructions make installation as easy as... One, Two, Three!

Applications for YJ and TJ Wrangler Vehicles:

- For '88-'95 Wrangler w/Upper Doors & Clear Windows #11000.00XX
- For '88-'95 Wrangler w/Upper Doors & Tinted Windows #11000.01XX
- ▶ Colors: 09 · 15 · 17
- For '97-'02 Wrangler w/Clear Windows #11000.02XX
- For '97-'02 Wrangler w/Tinted Windows #11000.03XX
- For '97-'02 Wrangler w/Upper Doors & Clear Windows #11000.04XX
- For '97-'02 Wrangler w/Upper Doors & Tinted Windows #11000.05XX
- ▶ Colors: 15 · 17 · 33
- For '03-'06 Wrangler w/Clear Windows #11000.0635
- For '03-'06 Wrangler w/Tinted Windows #11000.0735
- For '03-'06 Wrangler w/Upper Doors & Clear Windows #11000.0645
- For '03-'06 Wrangler w/Upper Doors & Tinted Windows #11000.0745
- ▶ Colors: 35



**QUADRATOPS
START AT
\$299.99!**

to the RESCUE!

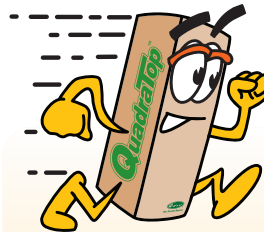

SAME DAY SHIPPING!*
**Factory Trained Soft Top
Advisors Always on Call!**

Go online or call for latest price...



**AFFORDABLE
QUALITY
WITH NO COMPROMISES!**

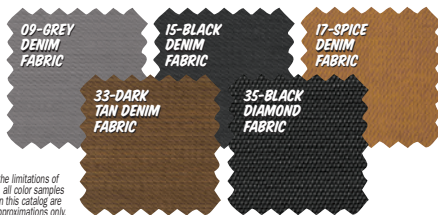

Due to the limitations of printing, all color samples shown in this catalog are close approximations only.

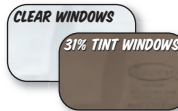

*Order an In Stock New QuadraTop Soft Top for Delivery in the Lower 48 States Before 4pm Eastern Standard Time, and It'll Ship UPS Ground the Same Day. Ground Shipments take between 1-7 Business Days to Deliver. Need Your Top Faster? Expedited Shipping Options are Available with a UPS Air Freight Surcharge.



The Trusted Source

Quadratec Limited Warranty

for QuadraTop® Clearview Windstopper Roll Bar Curtains

Your QuadraTop Clearview Windstopper is covered by the following **Limited Warranty** provided exclusively by Quadratec, Inc. 1028 Saunders Lane, West Chester, PA 19380.

This **Limited Warranty** is the only warranty made in connection with purchase. Quadratec neither assumes nor authorizes any vendor, retailer or other person or entity to assume for it any other obligation or liability in connection with this product or **Limited Warranty**.

What is Covered:

Subject to the terms, exclusions and limitations herein and with respect only to soft tops first sold in the United States, Quadratec warrants to the initial retail purchaser only that your QuadraTop Clearview Windstopper shall be free of defects in material and workmanship **for a period of 3 years from date of initial retail sale**.

All other warranties are hereby disclaimed, except to the extent prohibited by applicable law in which case any implied warranty of merchantability or fitness for a particular purpose on this product is limited to 3 years from date of initial retail sale. Quadratec reserves the rights to: (a.) require invoice or other proof your product is within the terms of this **Limited Warranty** as a condition of warranty service and, (b.) make future revisions to this product and **Limited Warranty** without prior notice or obligation to upgrade your product.

What is Not Covered:

Your Quadratec **Limited Warranty** does not cover products or parts Quadratec determines to have been damaged by or subjected to: (a.) installation damage, alteration, modification, failure to maintain or attempted repair or service by anyone not authorized by Quadratec, (b.) normal wear and tear, cosmetic damage or damage from water immersion, (c.) Acts of God, accidents, misuse, negligence, inadequate mounting or impact with vehicle(s), obstacles or other aspects of the environment, (d.) theft, vandalism or other intentional damage.

Remedy Limited to Repair/Replacement:

The exclusive remedy provided hereunder shall, upon Quadratec inspection and at Quadratec's option, be either repair or replacement of product or parts (new or refurbished) covered under this Limited Warranty. Customers requesting warranty consideration on QuadraTop soft top should first contact Quadratec to obtain a RGA number (610-701-3336). All labor, removal, shipping and installation costs are customer's responsibility.

Other Limitations - Exclusion of Damages - Your Rights Under State Law:

In consideration of the purchase price paid, neither Quadratec nor any independent Quadratec distributor/licensee are responsible for any time loss, rental costs, or for any incidental, consequential, punitive or other damages you may have or incur in connection with any part or product purchased. Your exclusive remedy hereunder for covered parts is repair/replacement as described above.

This **Limited Warranty** gives you specific rights. You may also have other rights that vary from state to state. For example, some states do not allow limitations of how long an implied warranty lasts and/or do not allow the exclusion or limitation of incidental or consequential damages, so the limitations and exclusions herein may not apply to you.

©Quadratec, Inc. 2013. All Rights Reserved.
Version 12.02.13 A4

The terms Quadratec®, QuadraTop®, Essentials® and Essential® are Registered Trademarks of Quadratec Inc. Registered in U.S. Patent and Trademark Office.

Part #12999.8004



The Trusted Source