

QuadraTop® Clearview Windstopper

Installation Manual for '07-'Current Jeep® JK Wrangler Vehicles
#11028.0235 and #11028.0335



⚠ WARNING ⚠

Loss of vehicle control involves risk of death or serious injury, particularly to parts of your body not restrained within vehicle. This product is intended for weather protection only and should not be relied upon to contain occupants in the event of an accident or to protect from either ground contact or falling objects. To reduce risk of accident or injury:

- **ALWAYS WEAR SEATBELTS**
- Always keep head, arms & body parts within vehicle.
- Fully secure or stow the fabric top before driving according to instructions. Never try to adjust the fabric top while driving. Do not use if damaged or worn.
- Read and follow all instructions & warnings accompanying this product, in your vehicle owner's manual and Off Road Driving Supplement.

⚠ CAUTION ⚠

RISK OF EYE INJURY. Safety glasses should be worn at all times while installing or maintaining this product.

PARTS LIST:

FABRIC WINDSTOPPER CURTAIN - QTY 1

FOR JK 2 DOOR VERSION:

MALE SIDE RELEASE BUCKLES - QTY 2

FOR JK 4 DOOR VERSION:

SNAP HEAD WITH PHILLIPS SCREW - QTY 3

PLASTIC ACORN NUT - QTY 3

REQUIRED TOOLS:

SAFETY GLASSES

FOR JK 4 DOOR VERSION:

PIECE OF CHALK (FOR MARKING)

PHILLIPS SCREWDRIVER

9MM WRENCH



The Trusted Source

Important Safety Information:

Your QuadraTop® Clearview Windstopper is intended to increase the fair weather enjoyment of your off-road capable vehicle. Before installation, please take a moment to review the

following safety information and installation instructions. Important safety information is generally preceded by one of three signal words indicating the relative risk of injury. The signal words mean:

⚠ WARNING ⚠

a hazardous situation which, if not avoided, could result in death or serious injury. You CAN be KILLED or SERIOUSLY HURT if you don't follow instructions.

⚠ CAUTION ⚠

a hazardous situation which, if not avoided, could result in minor or moderate injury. You CAN be moderately HURT and also may suffer property damage if you don't follow instructions.

NOTICE

Careful attention is required to this instruction or operation but does generally not relate to personal injury. Damage to your Quadratec® product or other property may result if you don't follow instructions.

Before You Begin Installation:

Congratulations on your purchase of the QuadraTop Clearview Windstopper! This high quality roll bar curtain is designed to enhance fair weather driving pleasure while limiting wind buffeting, providing shade and minimal shelter from light rains. We have used only the finest materials in creating this curtain but like any product that is exposed to the elements, there is some general maintenance that is required to keep it looking like new. Please see page 6 for these important maintenance tips.

When unpacking, check to make sure all parts are included. If any part is missing or broken, please call Quadratec Customer Service at 800-745-6037 as soon as possible.

Important: Make sure you become familiar with the installation process of this top by reading the following instruction sheet thoroughly. As you will see, these instructions are broken-out depending on the door configuration of your 07-Current JK Wrangler vehicle.



Important: For a smooth fit and ease of installation, this product should be installed at temperatures above 72 degrees. Below this temperature, the fabric may contract an inch or more making it difficult to install. We highly recommend taking the product out of the package and letting it sit inside a warm place or direct sun light for 1-2 hours before you install the top. When warm, this product will install quickly.

It is normal for fabric and soft glass to contract and wrinkle when stored in the shipping carton. In a few days the fabric will relax and wrinkles will disappear. Thank you again for your purchase and let's start the installation process!



The Trusted Source

Clearview Windstopper Installation:

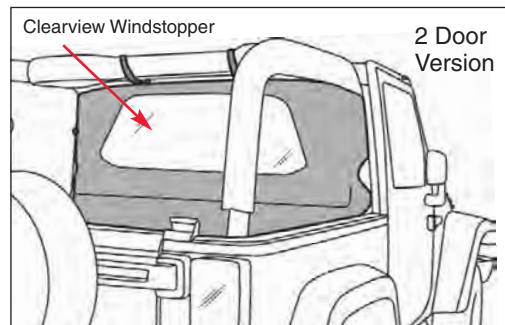
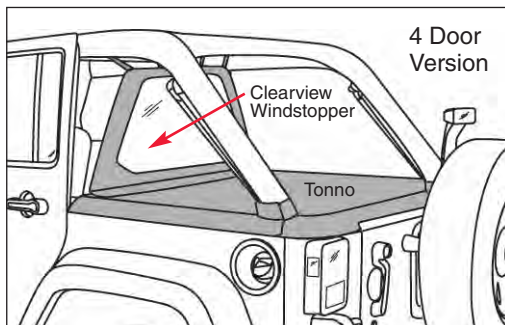

Clearview Windstopper Concept:

The Quadratop Clearview Windstopper cab curtain is ideally designed to attach to the leading edge of a separate Tonno Cover, also available from Quadratec. For the 4 Door Version, the Tonno is required for the Windstopper to be fully functional. The later steps of this instruction booklet show how to attach the Windstopper to the Tonno. If you still need to purchase a Tonno cover, go online to quadratec.com to find the correct application for your particular Jeep Wrangler vehicle.

Threading Straps Through Buckles:

Throughout the course of installation, you will need to thread the straps

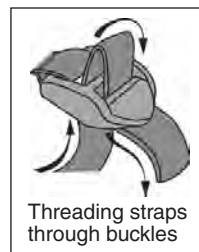

through the buckles several times. Please review the diagram for correct strap routing through all buckles.

ALWAYS WEAR SAFETY GLASSES DURING INSTALLATION PROCESS.

Step One: for ALL '07- Current JK

REMOVE ANY SOFT OR HARD TOP
Remove any soft or hard top present on your vehicle before you begin installation. Removal of top should follow the top manufacturer's instructions or guidelines. Safely set it aside.

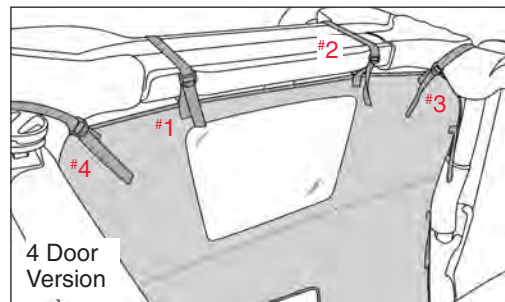

Step Two: for ALL '07- Current JK

SECURE ALL CENTER/TOP STRAPS
Orient the Clearview Windstopper with the window toward the top and with the vinyl side facing to rear of vehicle. Start with the center top straps and thread the end of each strap around the sport bar and through each buckle. Loosely tighten each strap to hold the Clearview Windstopper in position.

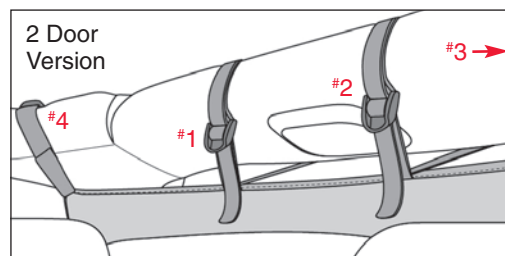

The Trusted Source

Step Three: for 2 Door JK Only

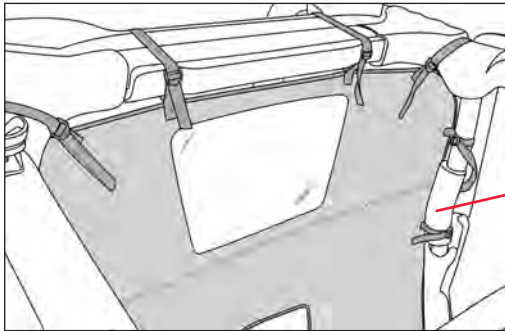

SECURE SIDE STRAPS TO SPORT BARS
Thread side straps loosely around the side sport bar on each side of vehicle.

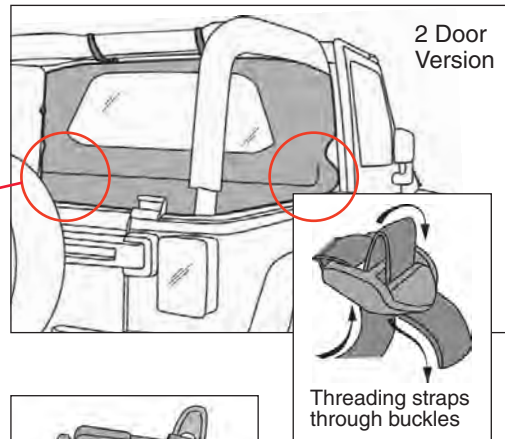

2 Door Version

Threading straps through buckles

Step Four: for 2 Door JK Only

THREAD BUCKLES ON STRAPS
As shown in Figure A, thread the end of the 15" buckle straps (attached to the curtain) through the male half of each quick-release buckle as shown.

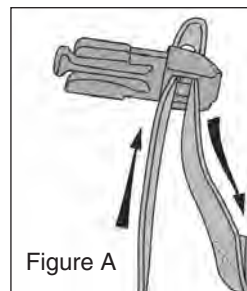
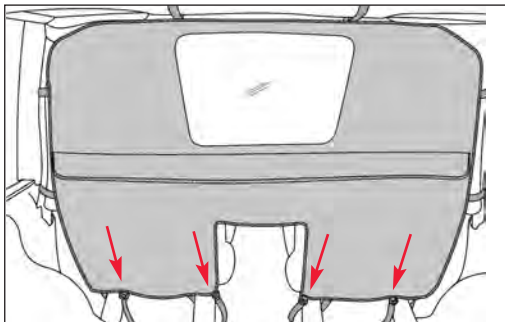
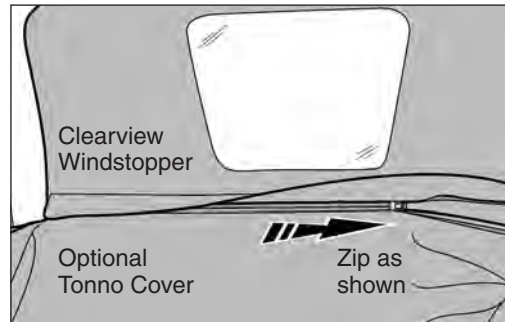
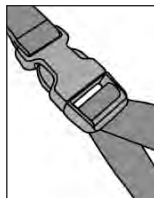

Figure A



Step Five: for 2 Door JK Only

SECURE WINDSTOPPER TO FACTORY SEAT BRACKETS
Pull down gently on the fabric and thread the 15" straps through the back of the seat brackets. Buckle the straps and then proceed to tighten all straps on the rollbar curtain.



Step Six: for 2 Door JK Only

SECURE WINDSTOPPER TO TONNO
If you have an optional Quadratec Tonno Cover for your vehicle, attach it to the zipper under the flap on the Clearview Windstopper.

Install complete for 2 door JK Clearview Windstopper!



The Trusted Source

Step Three: for 4 door JK only

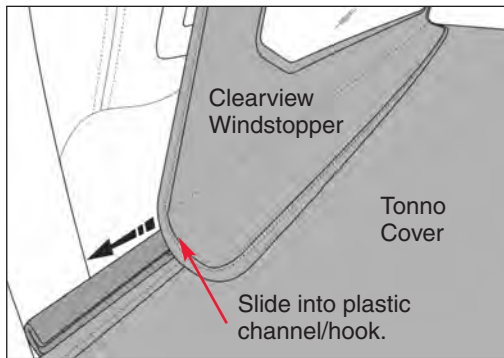

As mentioned in the introduction, the Clearview Windstopper for 4 Door JK Wrangler is only fully functional when used in conjunction with our QuadraTop Tonno Cover. These are the steps to make the proper attachment between your Clearview Windstopper and the compatible Tonno Cover.

SECURE TONNO TO CLEARVIEW WINDSTOPPER

With your Tonno Cover in position, slide the plastic hook inside the bottom of the Clearview Windstopper onto the plastic hook along the front of the Tonno.

OPTIONAL: INSTALL 3 SNAPS TO SECURE TONNO TO CURTAIN
Pull the flap on the rear of the Clearview Windstopper out over the top of the front edge of the Tonno. Rub chalk on the snaps on the Windstopper flap.

Step Four: Bimini Plus for 4 door JK

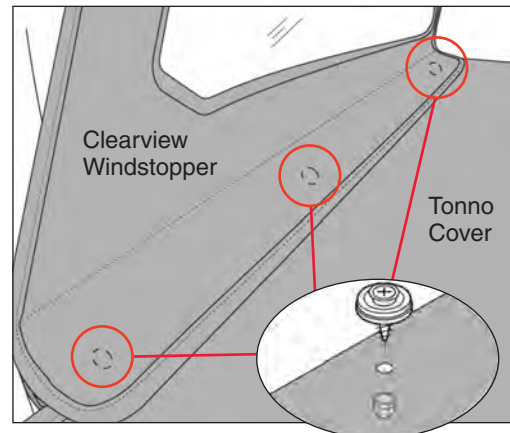

Pull up on the front reinforced edge of the Tonno and press the snaps against the Tonno to mark the locations.

At the 3 marked locations, push the sharp end of a Snap Head Screw through the Tonno from the backing side and through both layers of fabric, to make a hole for each snap. Once the holes are formed, pull the screw back out of the hole. Then push the screw through the hole from the finished vinyl side so that the snap is on top of the vinyl. Using a phillips head screwdriver and a 9mm wrench, install an Acorn Locknut over the pointed end of each Snap Head Screw. Snap each of the 3 snaps for secure attachment.

Install complete for 4 door JK Clearview Windstopper!



The Trusted Source

Care and Maintenance:

Your QuadraTop accessory is made of the finest materials available but to keep it looking new and for the maximum possible wear, it will need periodic cleaning and basic maintenance. The main threats to your soft top are pollutants, dirt and grime. By keeping your product clean you will prolong its life. We recommend the following to keep your top like new:

Washing: The soft top fabric should be washed often using a mild soap, warm water and a soft bristle brush. You can also use special soft top cleaners available on our website at quadratec.com. Make sure that after cleaning you rinse with clear water to remove all traces of soap to avoid residue.

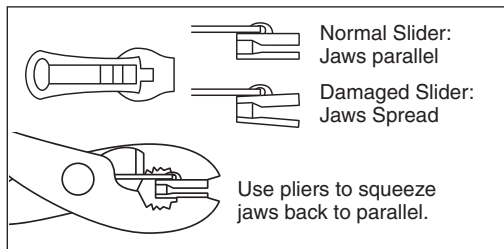

Zippers: Keeping the zipper cleaned and lubricated with a silicone lubricant (available online) will help prevent damage and keep the zippers in a smooth working condition. If zipper opens behind the slider, the slider may have been spread apart. This problem can usually be fixed by using an ordinary pair of pliers to bring the sides back into parallel. Return slider to the end of the zipper in the normal Open position. Squeeze lightly at first and test zipper. If the zipper continues to remain open squeeze more firmly with pliers and try the zipper again. Repeat procedure until your zipper operates correctly.

Windows: It is very important that you keep your QuadraTop windows clean! Use a mild soap and water solution to gently clean your windows. NEVER wipe your windows clean with a dry cloth! Dust and dirt on a dry cloth can scratch your windows causing "fogging" and permanent damage. When removing your windows, store them with a towel between the panels/rear windows to protect them from damage. If frost or ice forms on the outside of your windows during the winter, DO NOT use an ice scraper to remove this frost. Over time you will see small micro scratches in your windows which are natural wear and tear. These Micro scratches can be "polished" out using the window polish available at Quadratec.com.

Water/Fabric: In the event of seeping through the seams, 3M Scotchgard® may be applied on the inside of the seams to stop the leak. Rips in the fabric may be repaired with Bondex® iron on patches. Iron the patches to the Inside of the top, carefully following the Bondex® instructions.

Snaps: Not all models have snaps. If present, keep snaps cleaned and lubricated with silicone to help prevent snaps from sticking to the studs. If a snap does become stuck to a stud, use a screwdriver and GENTLY pry apart to prevent permanent damage to the snap or the top fabric.



The Trusted Source

QuadraTop® Replacement Soft Tops

Affordable quality and durability with no compromises! Our top kits are designed to work with factory hardware and feature finer quality materials and workmanship along with the latest in manufacturing technologies for unprecedented value. Our new product team with decades of soft top knowledge and experience delivers you all the great features you want in a replacement top with unsurpassed customer service and support. Our QuadraTop is the best value in replacement soft tops compared to other tops costing hundreds more. If for any reason, you are not completely satisfied with your soft top purchase or have an installation question, please contact our professional customer support staff for a solution. All QuadraTops feature a limited Three year warranty against defects. The incredible fit & detailed instructions make installation as easy as... One, Two, Three!

Applications for '07- Current JK Wrangler Vehicles:

For '07-'09 Wrangler 2 Door without Doors #11000.0835

For '10-Current Wrangler 2 Door without Doors #11000.0935

For '07-'09 Wrangler 4 Door without Doors #11000.1035

For '10-Current Wrangler 4 Door without Doors #11000.1135

► Colors: 35

**QUADRATOPS
START AT
\$369.99!**

Go online or call for latest price...

to the RESCUE!

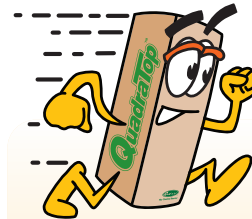

SAME DAY SHIPPING!*

**Factory Trained Soft Top
Advisors Always on Call!**



**BLACK
DIAMOND
FABRIC**

Due to the limitations of printing, all color samples shown in this booklet are close approximations only.



31% TINT WINDOWS

**AFFORDABLE
QUALITY
WITH NO COMPROMISES!**



*Order an In Stock New QuadraTop Soft Top for Delivery in the Lower 48 States Before 4pm Eastern Standard Time, and It'll Ship UPS Ground the Same Day. Ground Shipments take between 1-7 Business Days to Deliver. Need Your Top Faster? Expedited Shipping Options are Available with a UPS Air Freight Surcharge.



The Trusted Source

Quadratec Limited Warranty

for QuadraTop® Clearview Windstopper Roll Bar Curtains

Your QuadraTop Clearview Windstopper is covered by the following **Limited Warranty** provided exclusively by Quadratec, Inc. 1028 Saunders Lane, West Chester, PA 19380.

This **Limited Warranty** is the only warranty made in connection with purchase. Quadratec neither assumes nor authorizes any vendor, retailer or other person or entity to assume for it any other obligation or liability in connection with this product or **Limited Warranty**.

What is Covered:

Subject to the terms, exclusions and limitations herein and with respect only to soft tops first sold in the United States, Quadratec warrants to the initial retail purchaser only that your QuadraTop Clearview Windstopper shall be free of defects in material and workmanship **for a period of 3 years from date of initial retail sale.**

All other warranties are hereby disclaimed, except to the extent prohibited by applicable law in which case any implied warranty of merchantability or fitness for a particular purpose on this product is limited to 3 years from date of initial retail sale. Quadratec reserves the rights to: (a.) require invoice or other proof your product is within the terms of this **Limited Warranty** as a condition of warranty service and, (b.) make future revisions to this product and **Limited Warranty** without prior notice or obligation to upgrade your product.

What is Not Covered:

Your Quadratec **Limited Warranty** does not cover products or parts Quadratec determines to have been damaged by or subjected to: (a.) installation damage, alteration, modification, failure to maintain or attempted repair or service by anyone not authorized by Quadratec, (b.) normal wear and tear, cosmetic damage or damage from water immersion, (c.) Acts of God, accidents, misuse, negligence, inadequate mounting or impact with vehicle(s), obstacles or other aspects of the environment, (d.) theft, vandalism or other intentional damage.

Remedy Limited to Repair/Replacement:

The exclusive remedy provided hereunder shall, upon Quadratec inspection and at Quadratec's option, be either repair or replacement of product or parts (new or refurbished) covered under this Limited Warranty. Customers requesting warranty consideration on QuadraTop soft top should first contact Quadratec to obtain a RGA number (610-701-3336). All labor, removal, shipping and installation costs are customer's responsibility.

Other Limitations - Exclusion of Damages

- Your Rights Under State Law:

In consideration of the purchase price paid, neither Quadratec nor any independent Quadratec distributor/licensee are responsible for any time loss, rental costs, or for any incidental, consequential, punitive or other damages you may have or incur in connection with any part or product purchased. Your exclusive remedy hereunder for covered parts is repair/replacement as described above.

This **Limited Warranty** gives you specific rights. You may also have other rights that vary from state to state. For example, some states do not allow limitations of how long an implied warranty lasts and/or do not allow the exclusion or limitation of incidental or consequential damages, so the limitations and exclusions herein may not apply to you.

©Quadratec, Inc. 2013. All Rights Reserved.

Version 12.02.13 A4

The terms Quadratec®, QuadraTop®, Essentials® and Essential® are Registered Trademarks of Quadratec Inc. Registered in U.S. Patent and Trademark Office.

Part #12999.8005



The Trusted Source