

Installation Instructions

I - Sheet Number BF76 Rev.A



Bugflector® - Bugflector II® - Carflector® - Chrome Hood Shield™

For proper installation and best possible fit, please read all instructions BEFORE you begin.
For technical assistance or to obtain missing parts, please call Customer Relations at 1-800-241-7219.

Important Safety Information



- CAUTION - Before driving, ensure that the hood shield is properly anchored to vehicle.
- Do not use automatic "brush-style" car washes.
- Do not use cleaning solvents of any kind.
- Periodically check all components for tightness.

Contents **NOTE:** Actual product may vary from illustration.

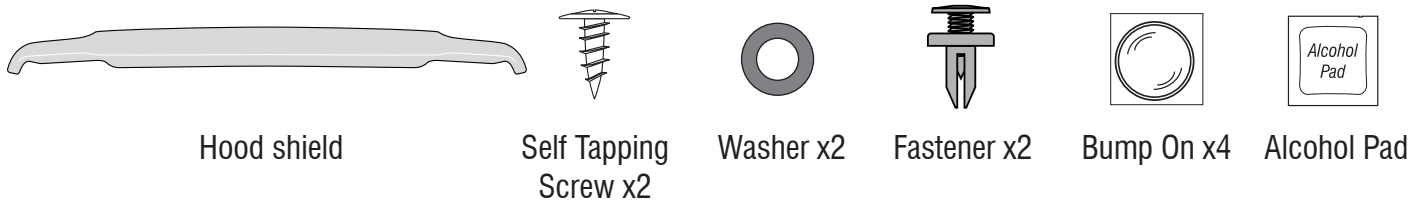

Tools Required

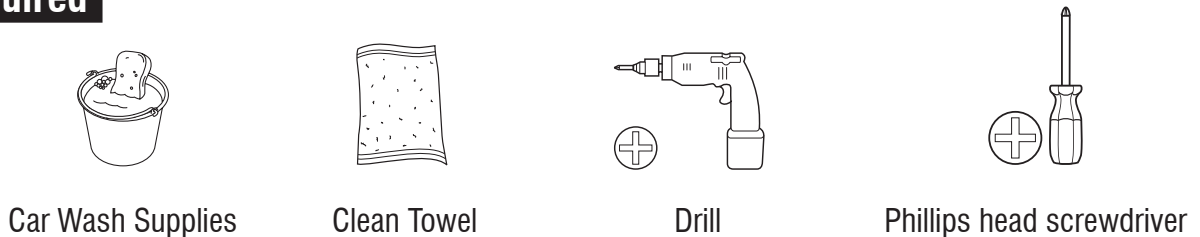

Preparation Before Painting / Installation

- A trial fit is recommended to ensure proper positioning and fit.
- Check fit of parts before painting as we will not accept the return of modified or painted parts.
- Wash your vehicle's hood to remove any debris and/or dirt.
- Dry the hood with a clean towel.

Installation Steps **NOTE:** Actual application may vary slightly from illustrations.

	<p>Open Hood. Clean indicated areas with an alcohol pad.</p>	<p>Expose 2" (5 cm) of tape liner from each end of the flanges on the hood shield.</p>
<p>1</p>		

Installation Steps **NOTE:** Actual application may vary slightly from illustrations.

Center part on front edge of hood and align holes.

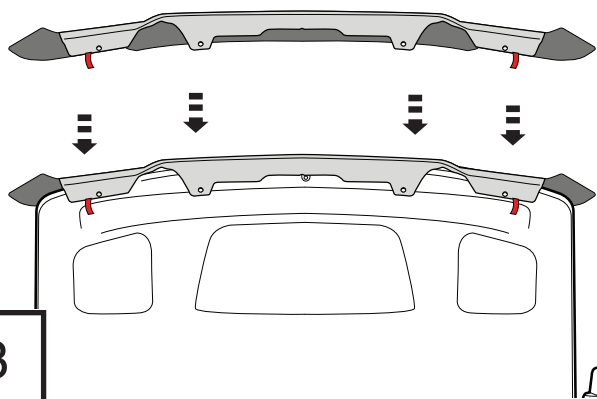

3

Install (2) fasteners in the INBOARD holes.

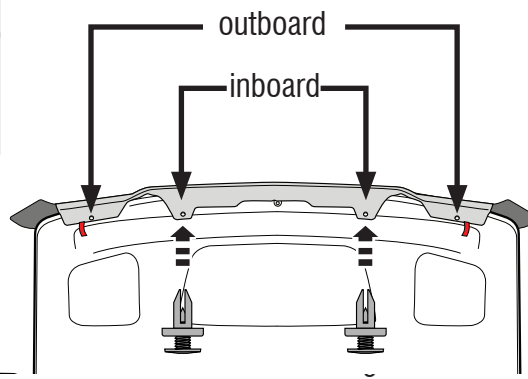

4

Remove remaining tape liner by pulling on exposed ends. Apply pressure to outboard flanges to ensure tape adhesion.

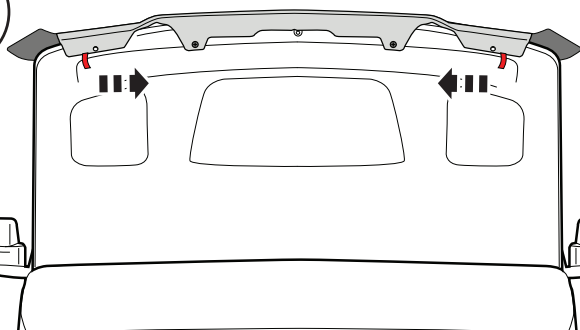

5

Install (2) self tapping screws through the OUTBOARD holes on hood shield.

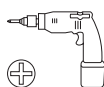

6

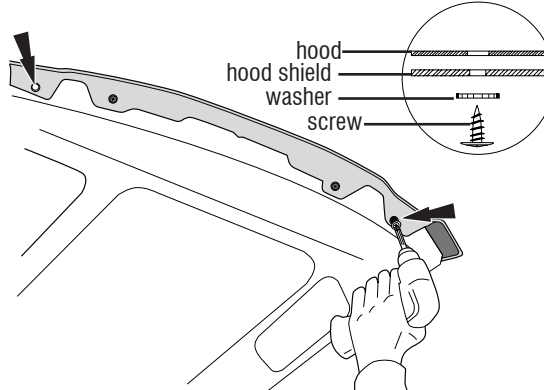

Close Hood.

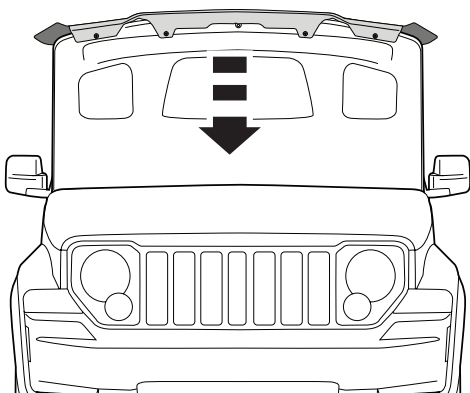

7

Apply bump ons to surface of hood.

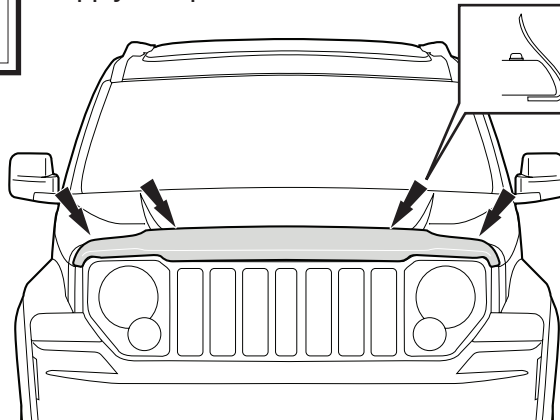

8

Care and Cleaning

- Wash only with mild soap & dry with a clean cloth.

Congratulations!

You have purchased one of the many quality Auto Ventshade™ branded products offered by Lund International, Inc. We take the utmost pride in our products and want you to enjoy years of satisfaction from your investment. We have made every effort to ensure that your product is top quality in terms of fit, durability, finish and ease of installation.



Lund International, Ventshade Accessories Division

655 Raco Drive, Lawrenceville, GA 30045

800-241-7219 • Fax 770-339-5839 • Visit us at lundinternational.com

© 2007 Lund International, Inc. All rights reserved.



Auto Ventshade™, the Auto Ventshade™ logo, Chromelector™, and the AVS™ logo are trademarks of Lund International, Inc.





Bugflector® - Bugflector II® - Carflector® - Chrome Hood Shield™

Pour obtenir une installation correcte et le meilleur ajustement possible, lire toutes les instructions AVANT de commencer. Pour toute assistance technique ou obtention de pièces manquantes, appeler le service des relations avec la clientèle au 1-800-241-7219.

Informations importantes concernant la sécurité



- ATTENTION – Avant de conduire, s'assurer que le pare-insectes est solidement assujéti sur le véhicule.
- Ne pas utiliser les stations de lavage de voitures à brosses.
- Ne pas utiliser de solvants.
- Vérifier régulièrement le serrage des composants.

Contenu REMARQUE : Le produit peut être différent de celui représenté sur l'illustration.

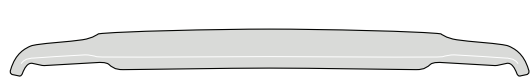

Pare-insectes



Vis (2)



Rondelle (2)

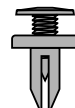

Attache (2)



Butoirs (4)



Tampons à l'alcool

Outils nécessaires



Fournitures pour lavage de voiture



Serviette propre

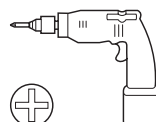

Foret



Tournevis cruciforme

Préparation pour la peinture/l'installation

- Il est recommandé de procéder à un essai pour s'assurer que le positionnement et l'ajustement sont corrects.
- Vérifier l'ajustement des pièces avant peinture, car nous n'acceptons pas le retour de pièces modifiées ou peintes.
- Laver le véhicule pour éliminer toute poussière et tous débris.
- Sécher le capot avec une serviette propre.

Étapes d'installation

REMARQUE : La méthode d'application peut être légèrement différente de celle représentée par les illustrations.



Ouvrez le capot. Nettoyez les zones indiquées à l'aide d'un chiffon imbibé d'alcool.

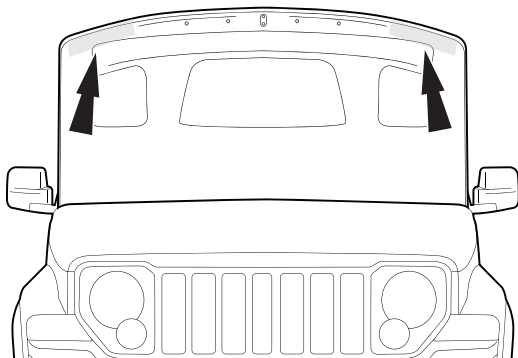

1

Découlez 5 cm de ruban adhésif à chaque extrémité des rabats de la protection de capot.

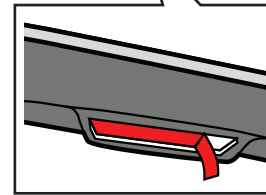
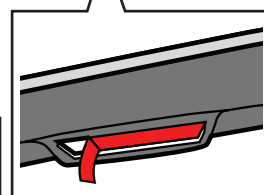
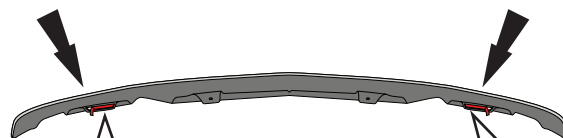

2

Étapes d'installation

REMARQUE : La méthode d'application peut être légèrement différente de celle représentée par les illustrations.

Centrez la pièce devant le capot et alignez les trous.

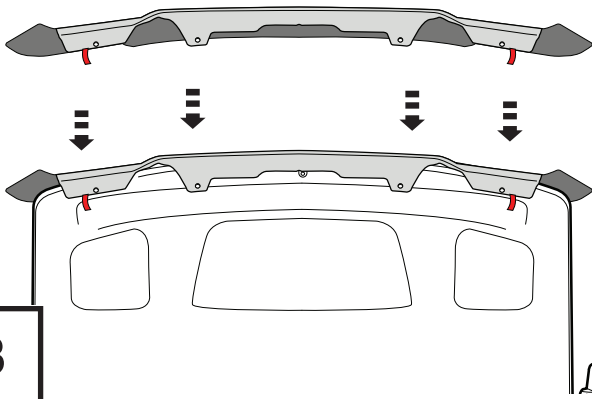

3



4

Installez les (2) attaches dans les trous INTÉRIEURS.

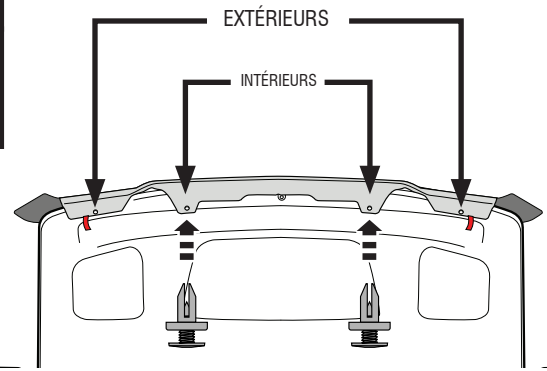

Retirez le ruban adhésif restant en tirant sur les extrémités décollées. Appuyez sur les rabats extérieurs afin d'assurer le bon collage du ruban.

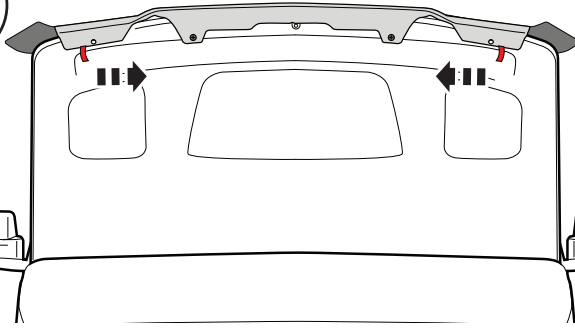

5

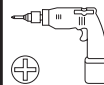

6

Installez les (2) vis autotaraudeuses dans les trous EXTÉRIEURS de la protection de capot.

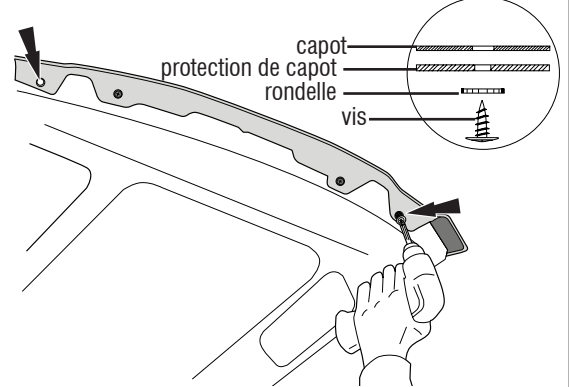

Fermez le capot.

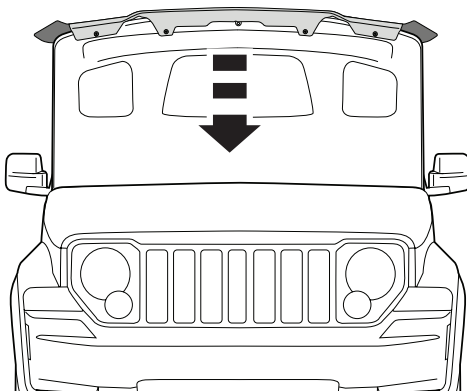

7

Appliquez les tampons de protection à la surface du capot.

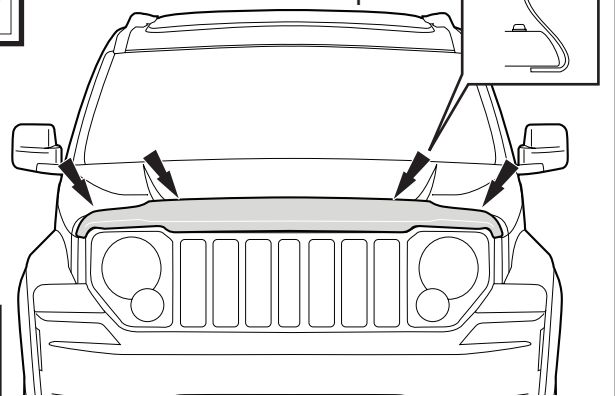

8

Entretien et nettoyage

- Laver exclusivement avec de l'eau savonneuse et sécher avec un chiffon propre.

Félicitations !

Vous avez acheté l'un des nombreux produits de qualité Auto Ventshade™ fabriqués par Lund International, Inc. Nous sommes extrêmement fiers de nos produits et souhaitons que vous tiriez des années de satisfaction de votre investissement. Nous avons pris toutes les mesures nécessaires pour assurer que ce produit est d'une qualité supérieure en ce qui concerne l'ajustement, la durabilité, la finition et la facilité d'installation.



AUTO VENTSHADE™

Lund International, Ventshade Accessories Division
655 Raco Drive, Lawrenceville, GA 30045, USA

800-241-7219 • Fax 770-339-5839 • Visitez notre site lundinternational.com

© 2007 Lund International, Inc. Tous droits réservés.



Auto Ventshade™ le logo Auto Ventshade™, Chromeflector™ et le logo AVS™ sont des marques déposées de Lund International, Inc.



Instrucciones de instalación

Hoja informativa N.º BF76 Rev.A



Bugflector® - Bugflector II® - Carflector® - Chrome Hood Shield™

Para una instalación adecuada y el mejor ajuste posible, lea todas las instrucciones ANTES de comenzar. Si desea recibir asistencia técnica u obtener piezas faltantes, llame al Servicio al cliente al 1-800-241-7219.

Información importante de seguridad



- PRECAUCIÓN - Antes de conducir, asegúrese de que la cubierta para capó esté correctamente anclada al vehículo.
- No utilice servicios automáticos de limpieza de vehículos que utilizan cepillos.
- No utilice limpiadores al solvente de ningún tipo.
- Compruebe periódicamente que todos los componentes estén ajustados.

Contenido AVISO: El producto real puede variar con respecto a las ilustraciones.



Cubierta para capó



Tornillo x 2



Arandela x 2



Sujetador x 2



Soporte x 4



Paños esterilizados

Herramientas necesarias



Equipo de limpieza de vehículos

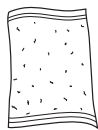

Toalla limpia

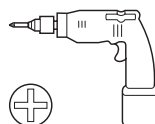

Taladro



Destornillador de cabeza Phillips

Preparación antes de pintar o instalar

- Se recomienda realizar un ajuste de prueba para asegurar el posicionamiento y ajuste correctos.
- Compruebe que las piezas se ajusten correctamente antes de pintarlas, ya que no aceptaremos la devolución de piezas modificadas o pintadas.
- Lave el capó del vehículo para quitar los desechos y la suciedad.
- Seque el capó con una toalla limpia.

Pasos de instalación NOTA: El uso real puede variar levemente de ilustraciones.



Abra el capó. Limpie las áreas indicadas con una almohadilla con alcohol.

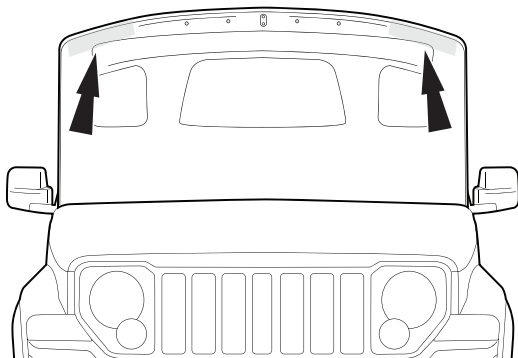

1

Deje al descubierto 2" (5 cm) del revestimiento de la cinta a cada extremo de los ribetes en el escudo del capó.

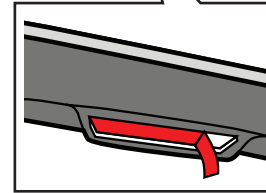
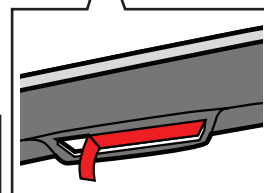
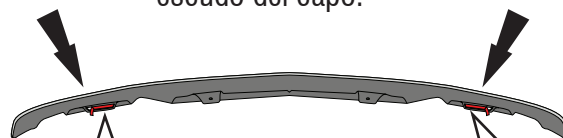

2

Pasos de instalación **AVISO:** La colocación real puede variar con respecto a las ilustraciones.

Centre la parte en el borde delantero del capó, con los agujeros alineados.

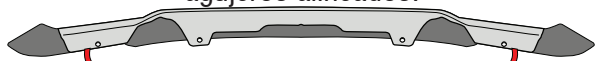

3



Instale (2) broches en los agujeros POR LA PARTE INTERIOR.

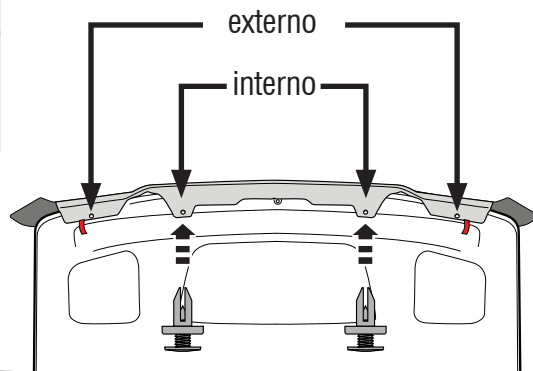

4

Elimine el resto del revestimiento de la cinta tirando de los extremos expuestos. Aplique presión a los ribetes externos para asegurar una buena adhesión de la cinta.

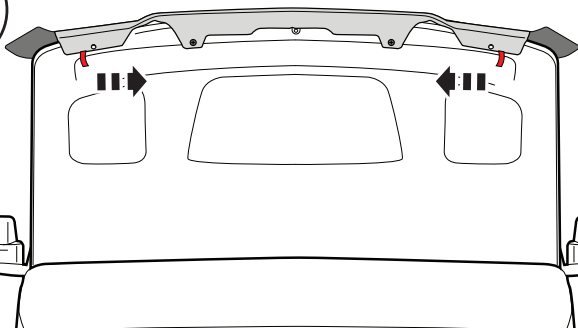

5

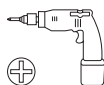

6

Instale (2) tornillos auto roscantes a través de los agujeros EXTERNOS en el escudo del capó.

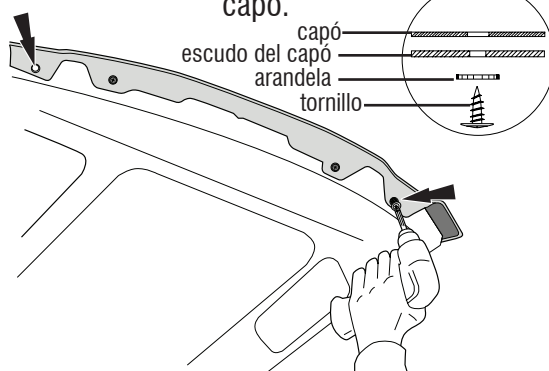

Cierre el capó.

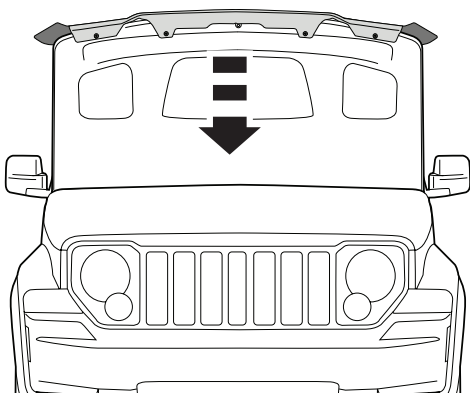

7



Coloque los toques en la superficie del capó.

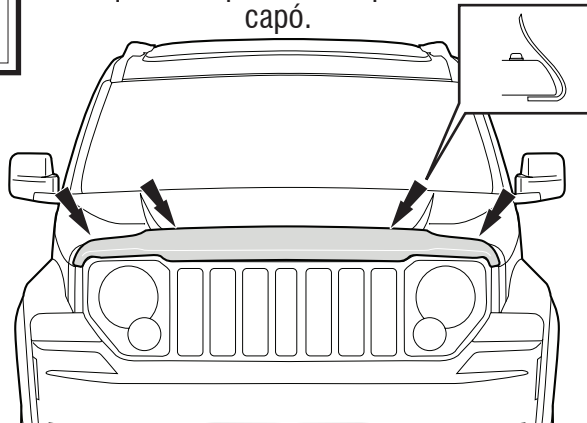

8

Cuidado y limpieza

- Limpie solamente con agua jabonosa tibia y seque con un paño limpio.

Felicidades

Usted ha comprado uno de los tantos artículos de calidad de Auto Ventshade™ ofrecidos por Lund International, Inc. Nuestros productos son nuestro mayor orgullo. Deseamos que disfrute de años de satisfacción con su inversión. Hemos realizado todos los esfuerzos para asegurarnos de que su producto sea de la mejor calidad en cuanto a ajuste, durabilidad, acabado y facilidad de instalación.



AUTO VENTSHADE™

Lund International, Ventshade Accessories Division

655 Raco Drive, Lawrenceville, GA 30045

800-241-7219 • Fax 770-339-5839 • Visite nuestro sitio Web: lundinternational.com

© 2007 Lund International, Inc. Todos los derechos reservados.

™ Auto Ventshade™ el logo de Auto Ventshade™, Chromeflector™ y el logo de AVS™ son marcas comerciales de Lund International, Inc.

