



3651 N Highway 89 • Chino Valley, AZ 86323
(928) 636-7080 • www.p-a-g.net

JEEP WRANGLER ROCK SLIDER FRONT BUMPER INSTALLATION INSTRUCTIONS 2007 **KIT# 83204**

Before Starting Installation

NOTE

Kit parts are prefaced by the word *kit* and appear in **bold print**.

1. Carefully read all warnings and instructions completely before beginning.
2. Verify all parts have been received in this kit by checking the parts list at the end of this document.

NOTE

If parts are missing from kit, please be prepared to provide the following information:

1. **Name** of purchase location
 2. **Bar Code** on side of box
 3. **Date** above bar code
 4. **Date** inside box cover
 5. **Inspector #** from inside box cover
3. **Only install this kit on the vehicle for which it is specified.** If anytime during the installation you encounter something different from what is outlined in the instructions, call technical support at (928) 636-7080.
 4. Park vehicle on a clean, dry, flat, level surface and block tires so vehicle cannot roll in either direction.

⚠ WARNING

Before you install this kit, read and understand all instructions, warnings, cautions, and notes in this instruction sheet and in the vehicle owner's manual.

⚠ CAUTION

Proper installation of this kit requires knowledge of the factory recommended procedures for removal and installation of original equipment components. We recommend that the factory shop manual and any special tools needed to service your vehicle be on hand during the installation. Installation of this kit without proper knowledge of the factory recommended procedures may affect the performance of these components and the safety of the vehicle. We strongly recommend that a certified mechanic familiar with the installation of similar components install this kit.

⚠ WARNING

Many states and municipalities have laws restricting bumper heights and vehicle lifts. Consult state and local laws to determine if the changes you intend to make to the vehicle comply with the law.

⚠ WARNING

Always wear eye protection when operating power tools.

⚠ WARNING

Before you install this kit, block the vehicle tires to prevent the vehicle from rolling.

Engine Compartment

1. Disconnect both battery cables. Disconnect negative cable first, then positive cable.

Prepare to Install Bumper

1. Remove four bolts, two push clips and lower splash guard from lower crush zone and front bumper.

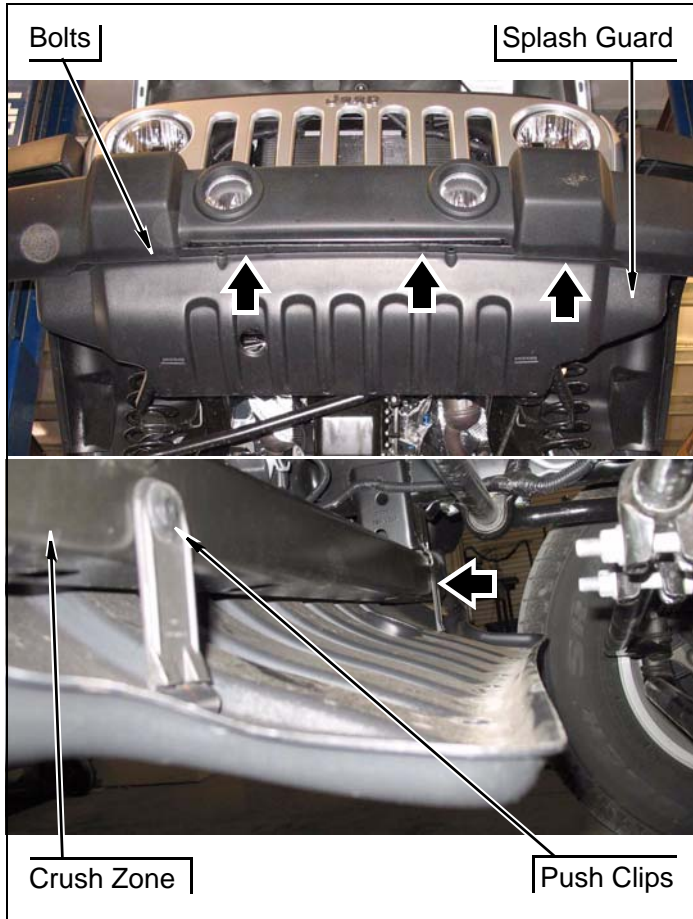

2. Disconnect fog lights wiring harnesses from fog lights if equipped.
3. Remove wiring harness and clips from lower crush zone.

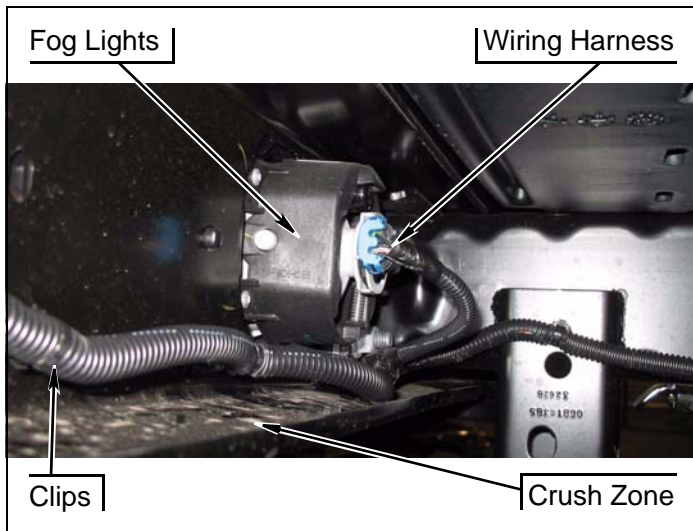

4. Remove four nuts, four spacer plates and front bumper from frame horns.

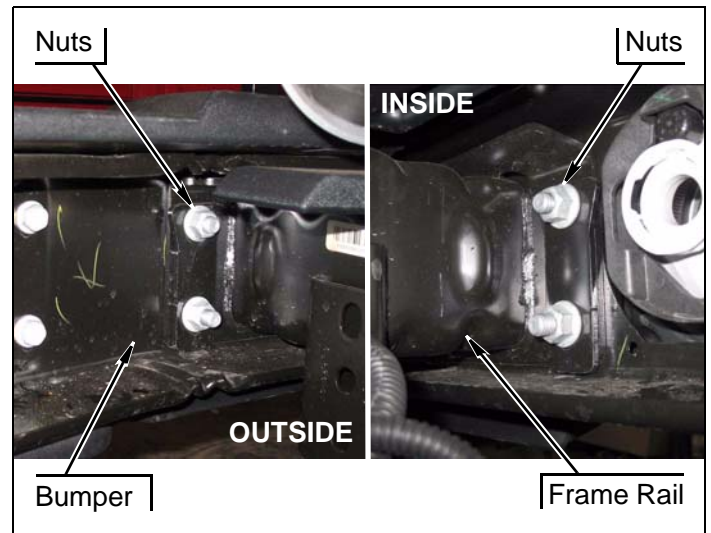

5. Remove eight screws and two fog lights from front bumper.

Install Bumper

NOTE
Bumper is designed to work with no fog lights, OE lights, or smaller aftermarket lights similar to the PIAA 510 series light.

1. **Aftermarket Lights**
 - a. Installing aftermarket lights, install in center hole on lower tab.

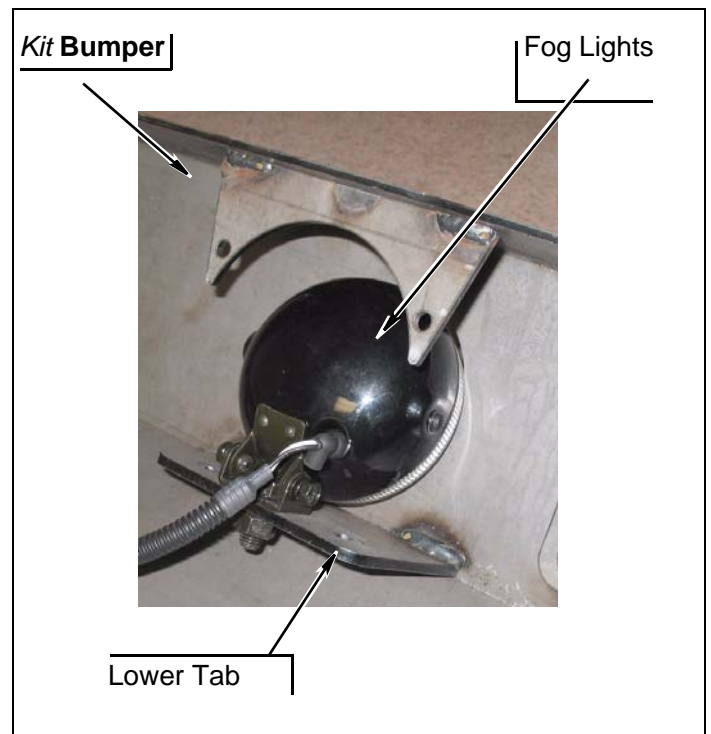

2. OE Fog Lights

- a. Install *kit OE light bracket* to mount OE lights onto *kit bumper* installing OE lights at the same time with twelve *kit bolts* (1/4"-20 x 1"), twenty four *kit washers* (1/4" SAE) and twelve *kit nuts* (1/4"-20 Nylock)..



3. No Fog Lights

- a. If no lights are being installed press in *kit urethane light hole plugs* to fill holes provided for lights.

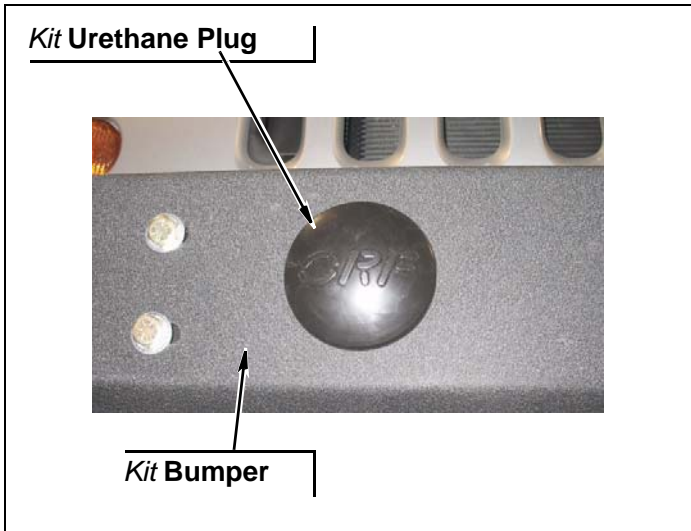

4. Place kit "D-ring" bracket into kit bumper slots.

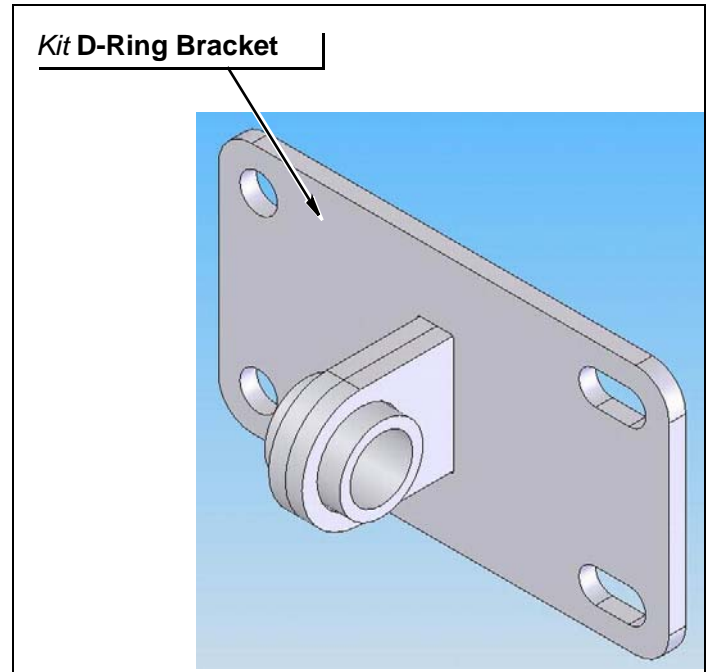

5. Install *kit bumper* onto frame horns with eight *kit bolts* (1/2"-13 x 1-1/4" button) and eight *kit nuts* (1/2"-13 Flange). DO NOT TIGHTEN.



6. Install **kit bumper** onto lower crush zone with four **kit nuts** (1/2"-13 Stover), four **kit large washers** (1/2" ID), and four **kit bolts** (1/2"-13 x 1-1/4" button). **TIGHTEN** all **kit bumper** hardware.



7. Connect fog light wiring harnesses onto fog lights.

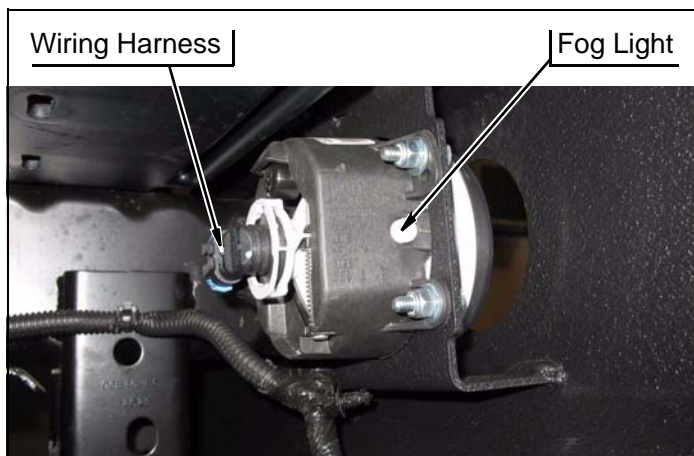

After Completing Installation

Engine Compartment

1. Connect both battery cables. Connect positive cable first, then negative cable.

Miscellaneous

1. Check all fasteners to ensure they are tight.
2. Ensure all wires, hoses, cables, etc. are properly connected and there is ample slack.

Dynamic Vehicle Check

1. Check steering in both directions to ensure that there is no bind. Check operation of clutch, brake system, and parking brake. Check operation of transmission and transfer case. Ensure there is full engagement in all gears and 4WD ranges. Check battery connections and electrical component operations. Test-drive vehicle.
2. Check steering and suspension in all positions to ensure that there is no bind and adequate clearance between all moving, fixed, and heated members. Check tire-to-bumper clearance and ensure no contact in any position. Test-drive vehicle.

⚠WARNING

Retorque all fasteners after 500 miles and after off road use. All body lift components should be visually inspected and fasteners retorqued during routine vehicle servicing.

⚠CAUTION

Performance Automotive Group does not recommend any particular wheel and tire combinations for use with its products and cannot assume responsibility for the customer's choice of wheels and tires. Refer to your owner's manual for recommended tire sizes and warnings related to the use of oversized tires. Larger wheel and tire combinations increase stress and wear on steering and suspension components, which leads to increased maintenance and higher risk for component failure. Larger wheel and tire combinations also alter speedometer calibration, braking effectiveness, center of gravity, and handling characteristics. Consult an experienced local off road shop to find what wheel and tire combinations work best with your vehicle.

NOTE

All warranty information, instruction sheets, and other documents regarding the installation of this product must be retained by the vehicle owner. Information contained in the instructions and on the warranty card will be required for any warranty claims. The vehicle owner needs to understand the modifications made to the vehicle and how they affect vehicle handling and performance. Failure to provide the customer with this information can result in damage to the vehicle and severe personal injury.

Kit Parts List

Qty. Description

1	Bumper
2	Bracket, OE Light
2	Bracket, D-Ring
1	Logo (label)
1	ZH83204 (Hardware bag)
12	Bolt (1/4"-20 x 1")
12	Bolt (1/2"-13 x 1-1/4" button)
12	Nut (1/4"-20 Flange)
12	Nut (1/2"-13 Flange)
4	Nut plate (1/2"-13)
24	Washer (1/4" SAE)
4	Washer (1/2" ID Large)
2	Urethane Light Plug