

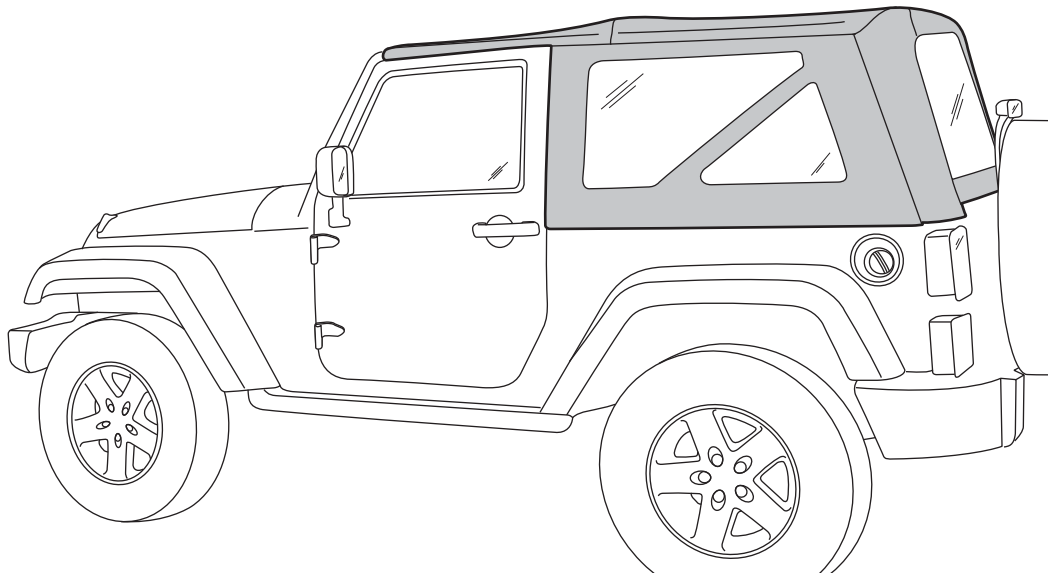

# JEEP WRANGLER

## 2 Door Top Kit



82213649  
82213650

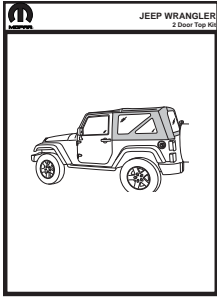

K6861727

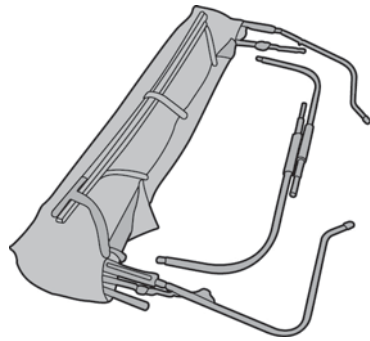

**A** 1X

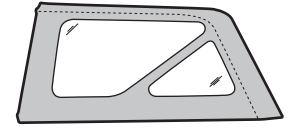

**B** 1X LH

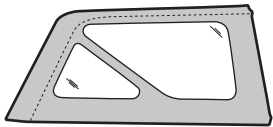

**C** 1X RH

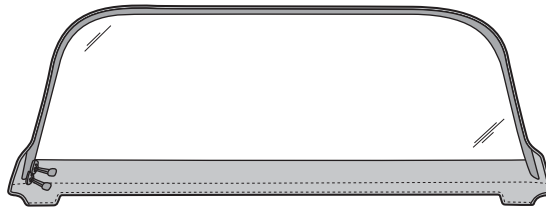

**D** 1X

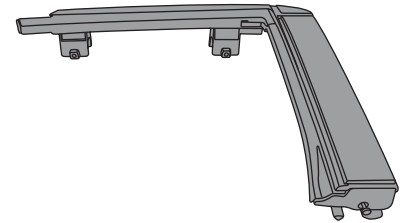

**E** 1X LH

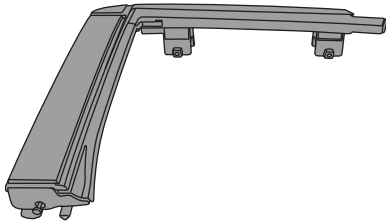

**F** 1X RH

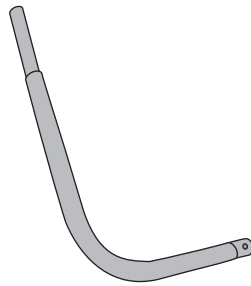

**G** 1X LH

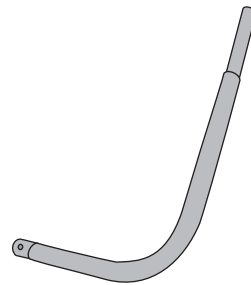

**H** 1X RH

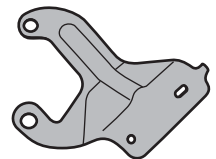

**I** 1X LH

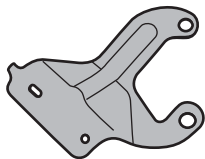

**J** 1X RH

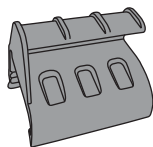

**K** 1X LH

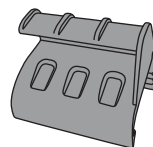

**L** 1X RH



**M** 1X

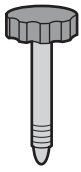

**N** 4X

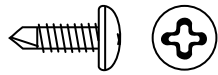

**O** 2X

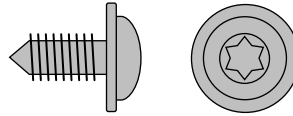

**P** 4X

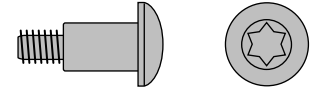

**Q** 4X

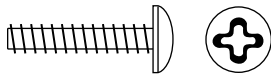

**R** 2X

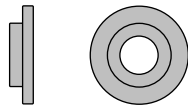

**S** 4X

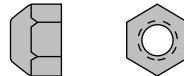

**T** 2X

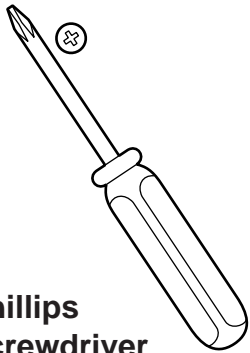

**Phillips  
Screwdriver  
Sizes 1, 2 and 3**

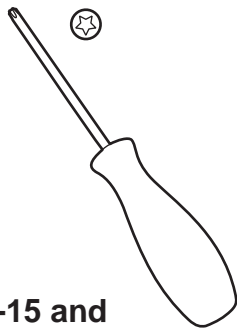

**T-15 and  
T-30 Torx**

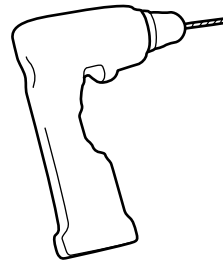

**Drill  
#2 Phillips Bit**

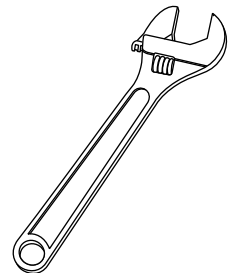

**Adjustable  
Wrench**

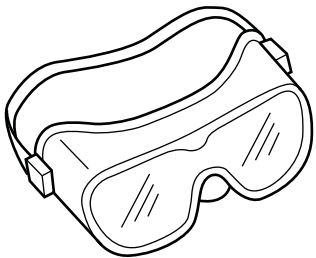

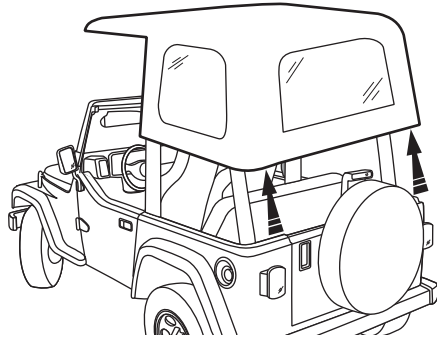

Remove the hard top.  
Refer to owner's manual  
for instructions.

1

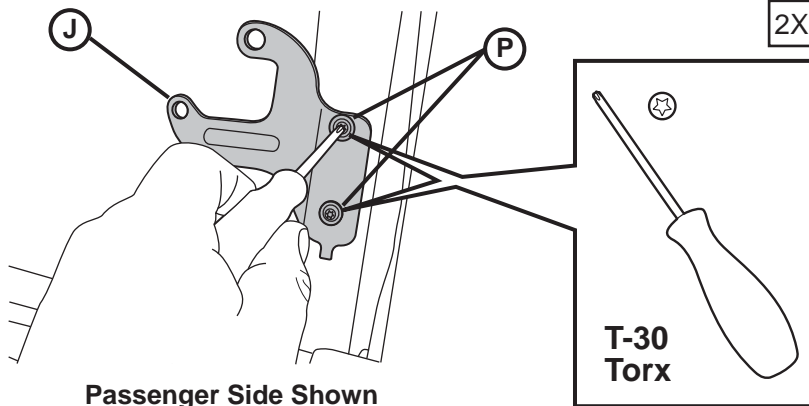

Use Bracket Screws  
to install Bow Mount  
Brackets on rear sport  
bar.

2

Passenger Side Shown

T-30  
Torx

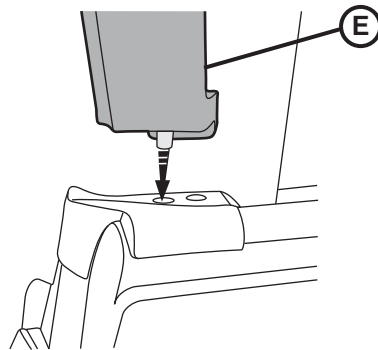

Locate the left and right  
Door Surrounds. Insert  
the pin in the bottom of  
the Door Surround into  
the hole in the belt rail  
behind the door.

3

Driver's Side Shown

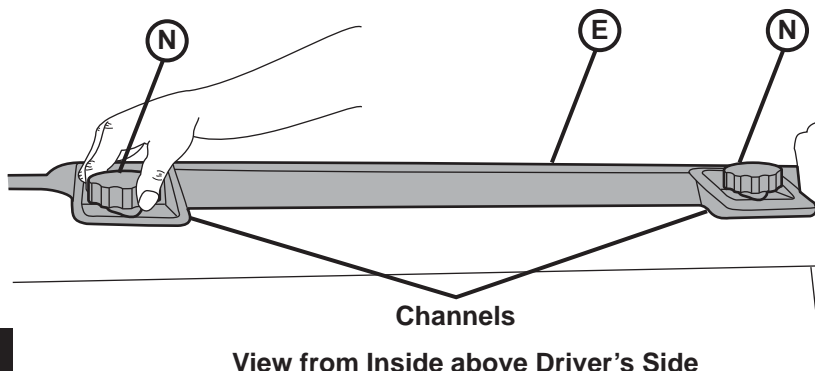

Press the channels  
along the top of the  
Door Surround around  
the horizontal sport bar,  
above the door opening.  
Insert two Knobs into  
the Door Surround and  
tighten them down.

4

Channels  
View from Inside above Driver's Side

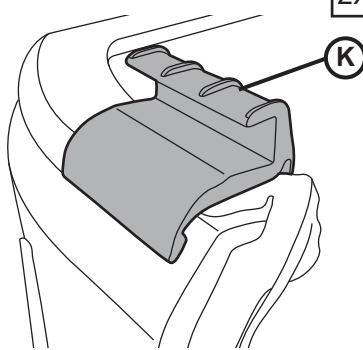

2X

Locate the left and right Tailgate Mounts. Orient them on the vehicle. Hook the bottom of one mount under the belt rail and roll it toward the inside of the vehicle until it clips into place. Repeat this with the other Tailgate Mount.

5

Driver's Side Shown

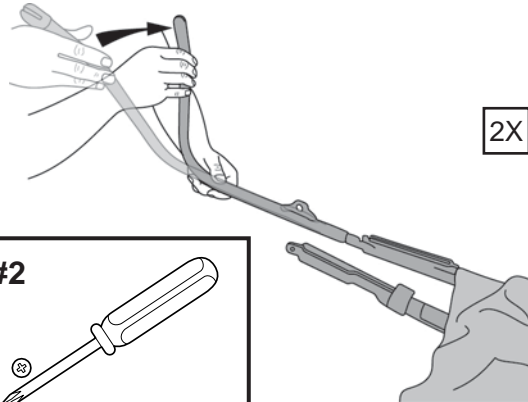
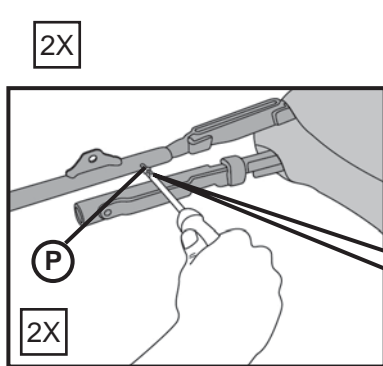

2X

2X

Rotate Side Bow 90 degrees until vertical. Insert screw into existing hole and tighten using Phillips screw driver.

6

Passenger Side Shown

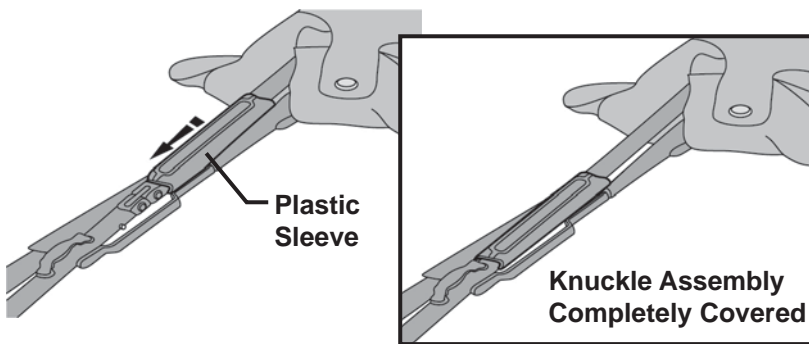

Slide plastic sleeve over knuckle assembly.

7

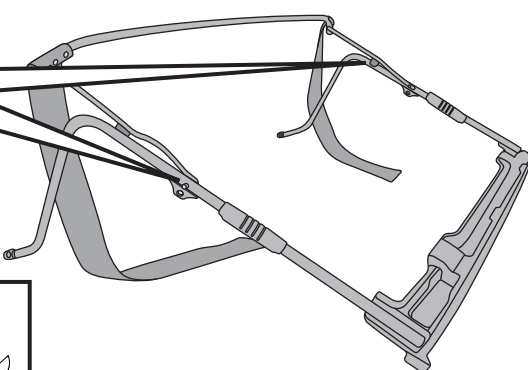
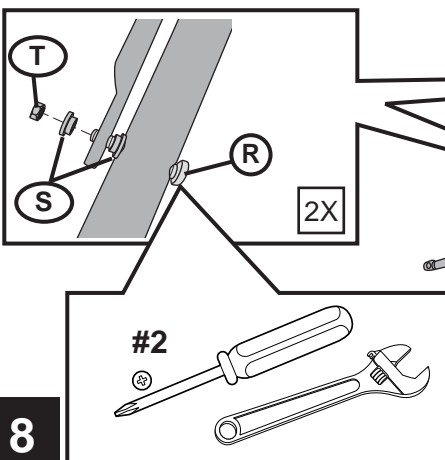

Locate the Center Bow Assembly. Align hole to the Side Bow Assembly and secure.

Use an M5 x 30 Machine Screw with two (2) Bushings and an M5 Nylock Nut.

8

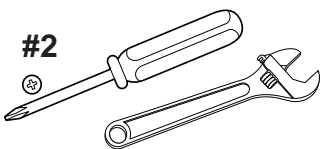

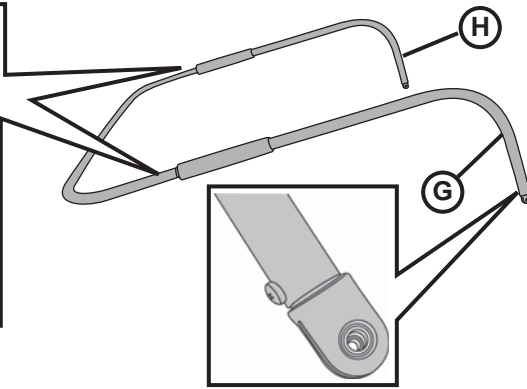
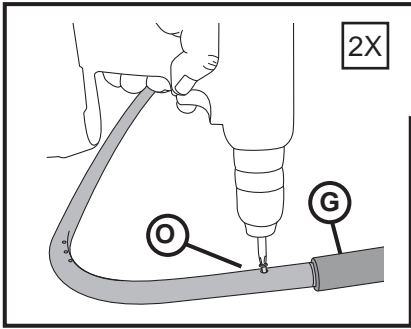

Locate the left and right Side Bows and orient them with the large holes to the outside. Mount them to the Rear Bow with a #8 x 1/2" Self Tapping Screw on each side.

9

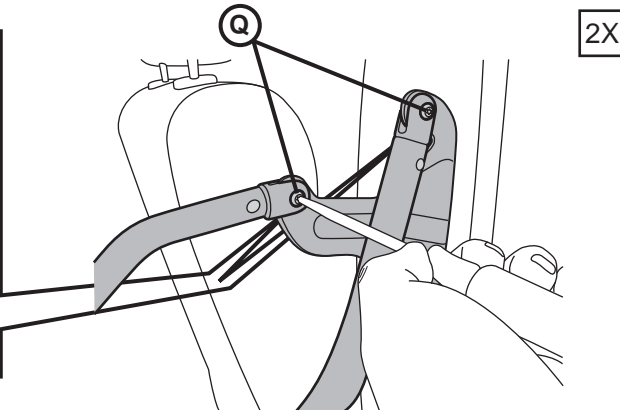
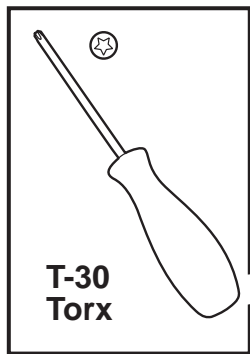

Place the Top Assembly on the vehicle. Use Pivot Knuckle Bolts to mount rear bow on Top Assembly to Bow Mount Brackets.

10

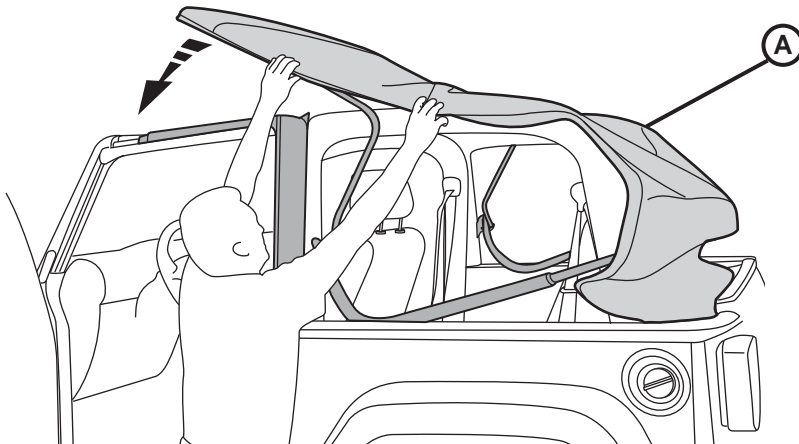

Open the Top Assembly and drape it over the cab of the vehicle.

11

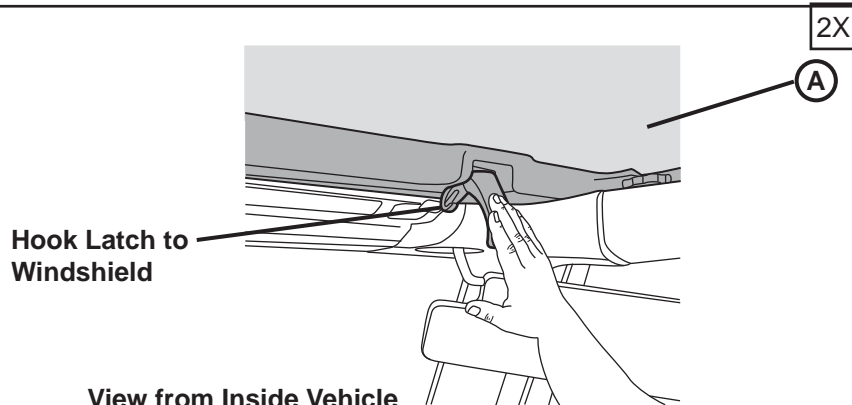

Close the front of the Top and secure the latches on the header to the windshield.

12

View from Inside Vehicle

2X

Roll Plastic  
into Channel

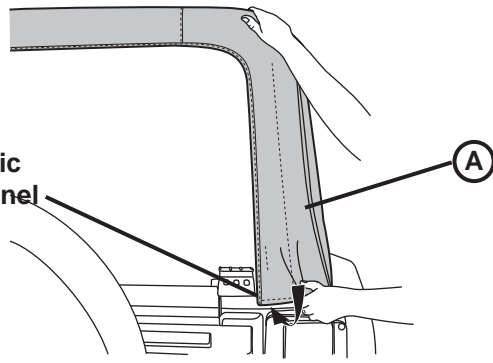

Slip the plastic strip in  
the rear corners of the  
Top into the channel on  
the vehicle.

13

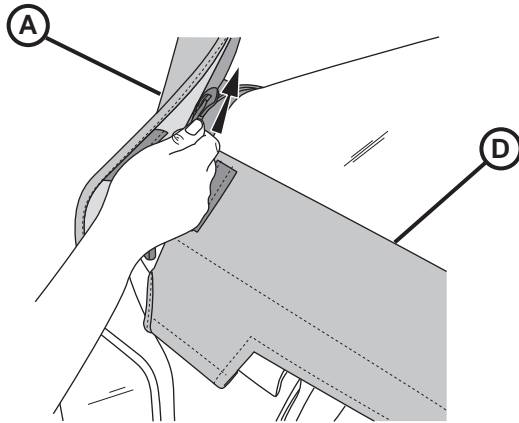

Start the zipper on the  
Rear Window and close  
it part of the way around.

14

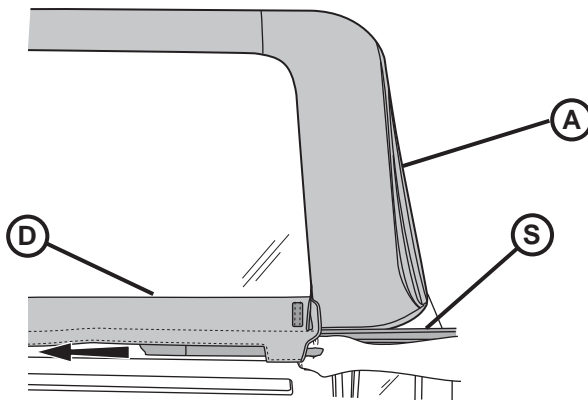

Slide the channel in the  
Tailgate Bar onto the  
tubing along the bottom  
of the Rear Window on  
the inside.

15

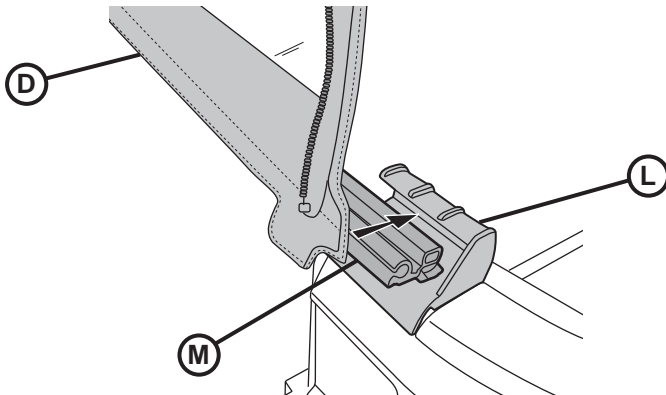

Slide the Tailgate  
Bar into the Tailgate  
Mounts on each side of  
the tailgate opening.

16

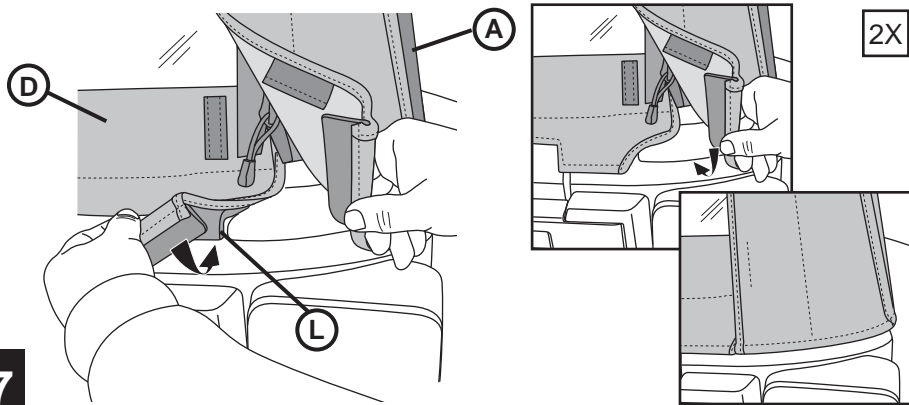

Slip the plastic strip in the Rear Window and Top into the channel on the vehicle.

17

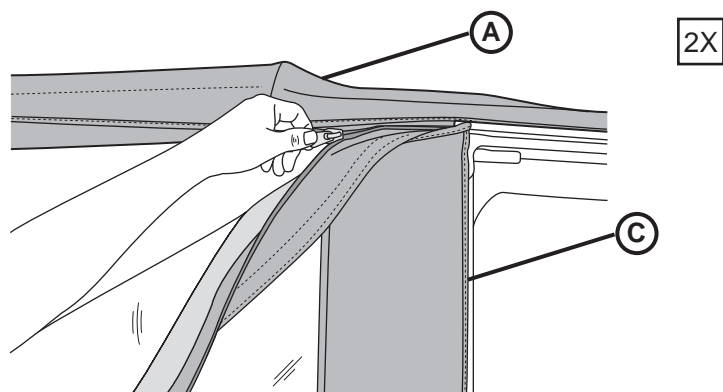

Start the zipper on the Side Window and close it 1-2 inches.

18

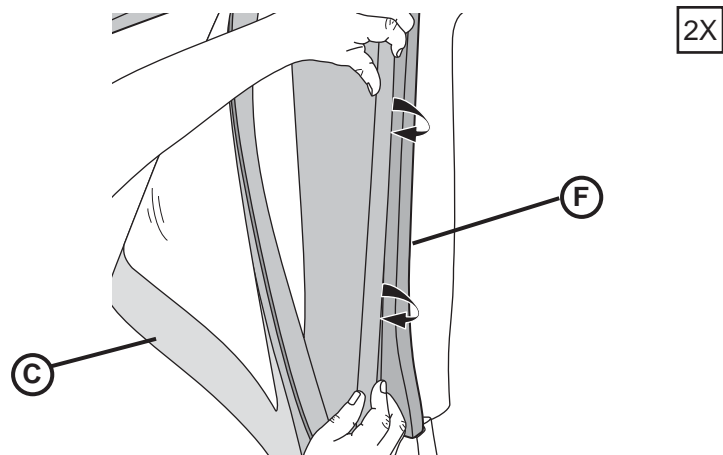

Roll the plastic strip along the front of the Side Window into the channel in the Door Surround.

19

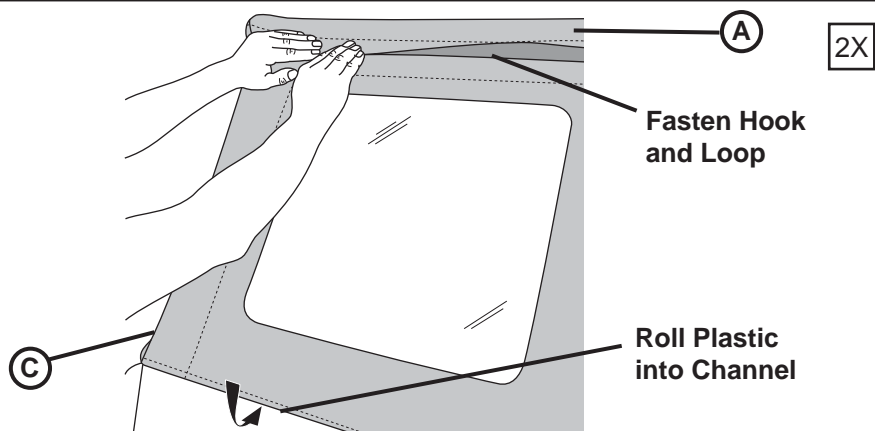

Close the zipper and slip the plastic along the bottom of the Side Window into the channel on the vehicle. Fasten the hook and loop strip above the window to the top.

20





# JEEP WRANGLER

## JUEGO PARA TOPE DE TECHO PARA VEHÍCULO DE DOS PUERTAS

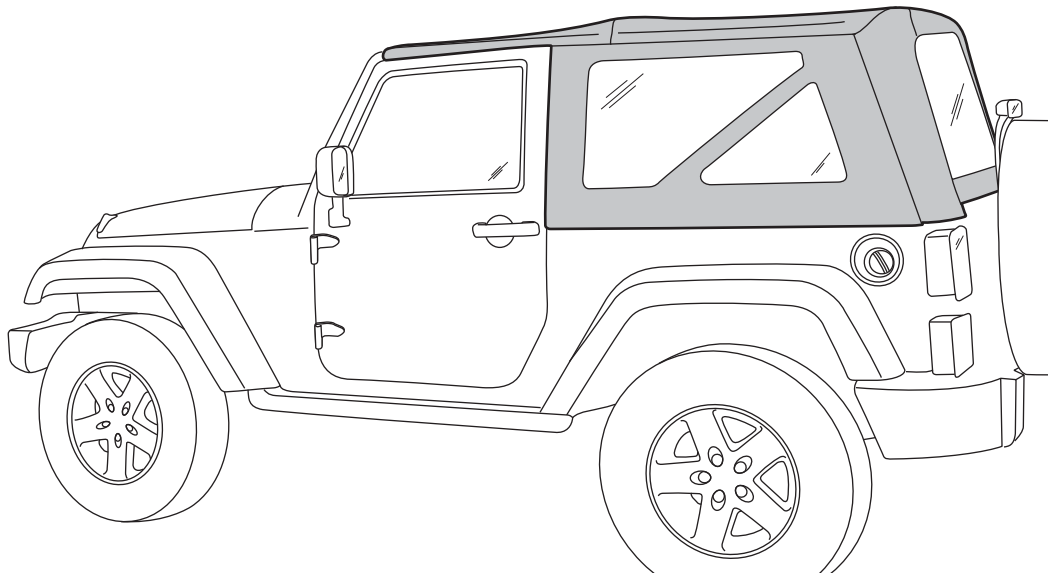

82213649  
82213650

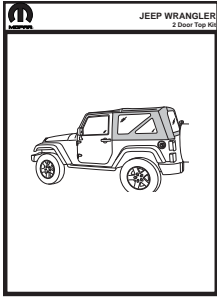

K6861727

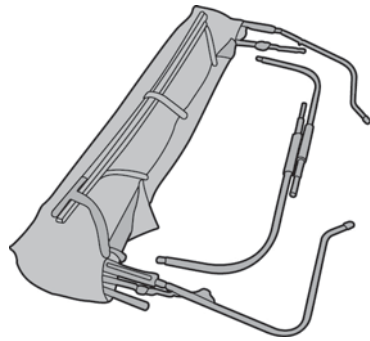

**A** 1X

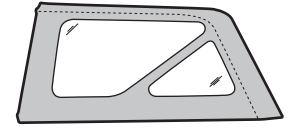

**B** 1X Mano izquierda

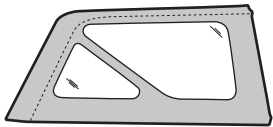

**C** 1X Mano derecha

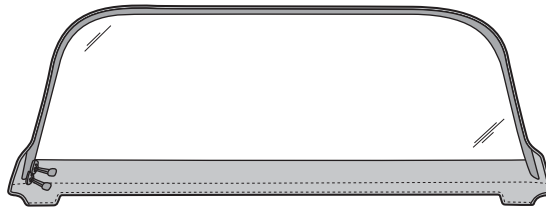

**D** 1X

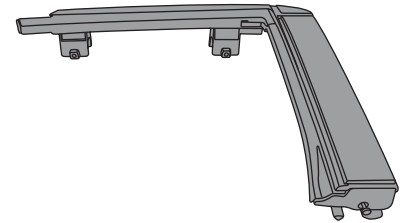

**E** 1X Mano izquierda

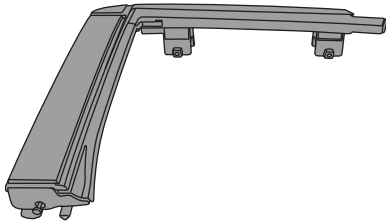

**F** 1X Mano derecha

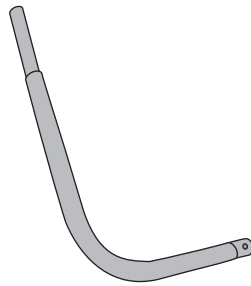

**G** 1X Mano izquierda

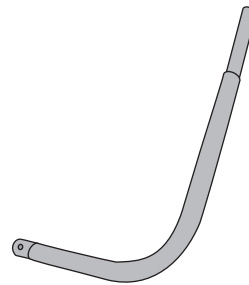

**H** 1X Mano derecha

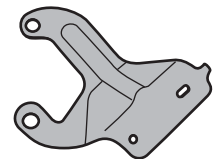

**I** 1X Mano izquierda

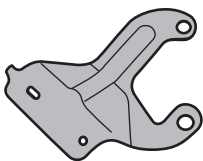

**J** 1X Mano derecha

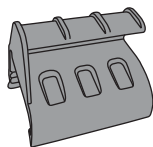

**K** 1X Mano izquierda

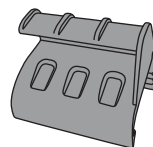

**L** 1X Mano derecha

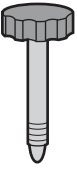
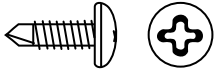
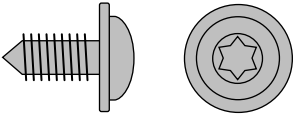
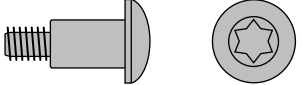
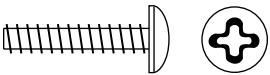
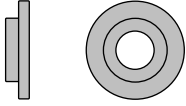
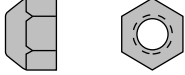
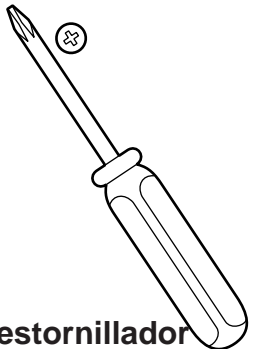
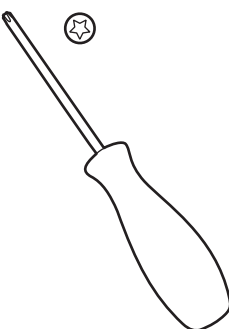
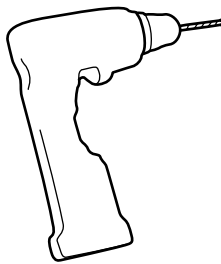
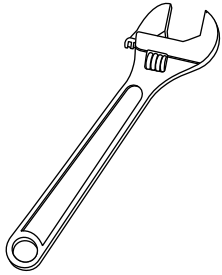
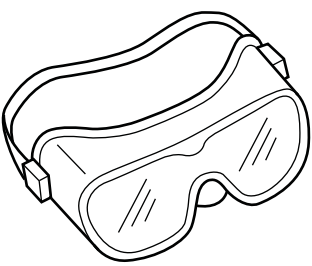

**M** 1X

 <p><b>N</b> 4X</p>	 <p><b>O</b> 2X</p>	 <p><b>P</b> 4X</p>	 <p><b>Q</b> 4X</p>
 <p><b>R</b> 2X</p>	 <p><b>S</b> 4X</p>	 <p><b>T</b> 2X</p>	
 <p><b>Destornillador Phillips tamaños 1, 2 y 3</b></p>	 <p><b>Destornillador T-15 y T-30 Torx</b></p>	 <p><b>Taladro con punta Phillips # 2</b></p>	 <p><b>Llave ajustable</b></p>
			

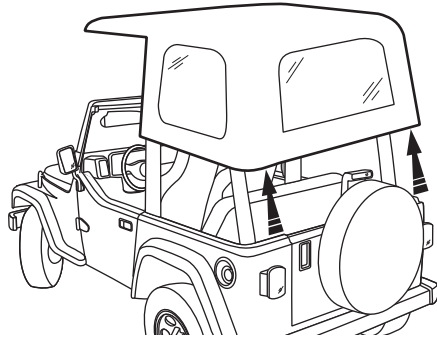

Retire el techo duro.  
Remítase al manual del  
propietario para las in-  
strucciones.

1

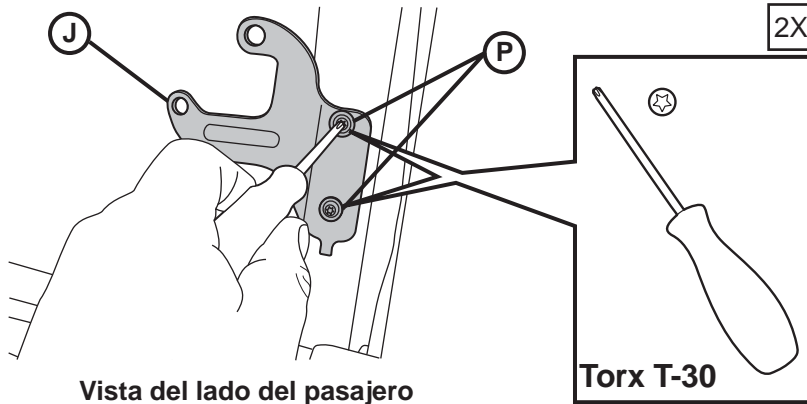

Vista del lado del pasajero

Torx T-30

Use los Tornillos para  
Bisagras para instalar  
las Bisagras del Basti-  
dor del Armazón sobre  
la barra antivuelco de la  
parte trasera.

2

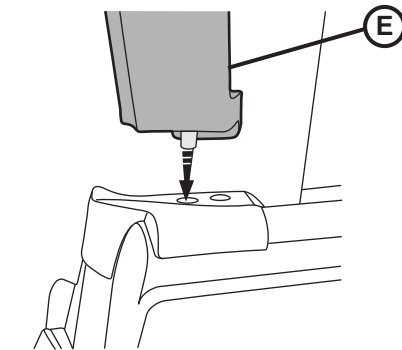

Vista del lado del conductor

2X

Ubique los Marcos de  
las Partes Superiores  
de las Puertas izquierda  
y derecha. Inserte el  
pasador en el fondo  
del Marco de la Parte  
Superior de la Puerta  
en el hueco del riel de  
la correa detrás de la  
puerta.

3

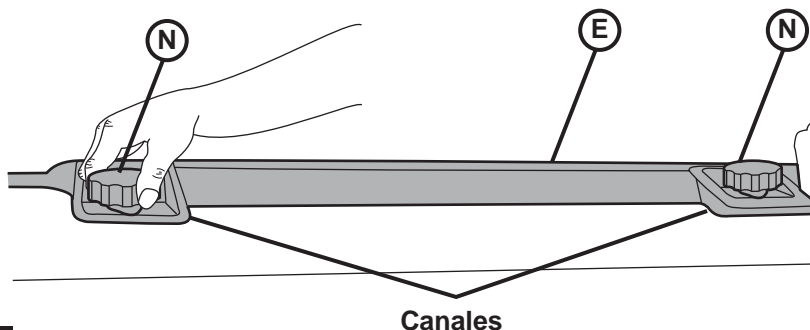

Vista desde el interior por encima del lado del conductor.

2X

Presione los canales a lo  
largo del tope del Marco  
de la Parte Superior  
de la Puerta alrededor  
de la barra antivuelco  
horizontal, arriba de la  
abertura de la puerta.  
Inserte las dos perillas  
en el Marco de la Parte  
Superior de la Puerta y  
apriételas.

4

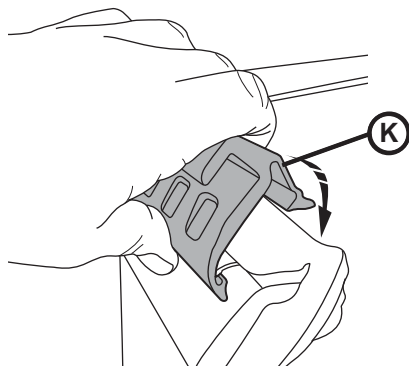

Vista desde lado del conductor

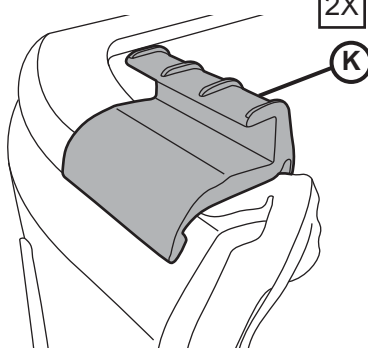

Ubique el bastidor izquierdo y derecho de la Compuerta Trasera. Diríjalos hacia el vehículo. Enganche la parte inferior de uno de los bastidores debajo del riel de la correa y enróllelo hacia el interior del vehículo hasta que el gancho lo agarre. Repita con el otro Bastidor de la Compuerta Trasera.

5

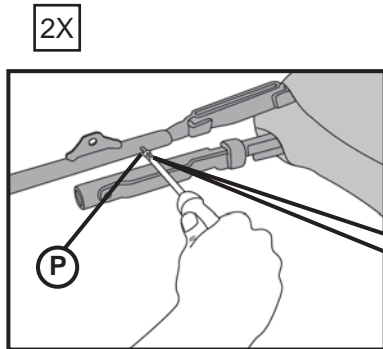

Vista del lado del pasajero

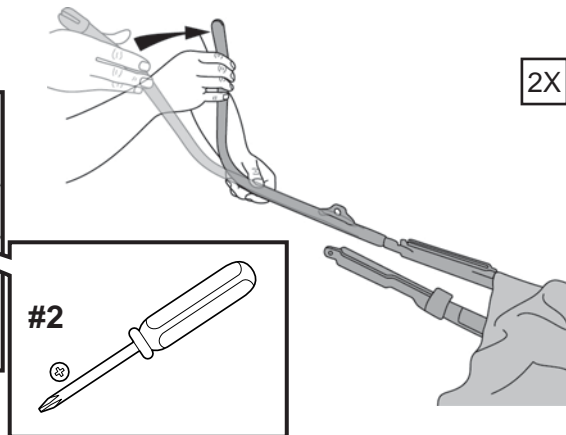

Gire el arco lateral 90 grados hasta colocarlo en posición vertical. Introduzca el tornillo en el agujero correspondiente y apriételo con un destornillador de cruz.

6

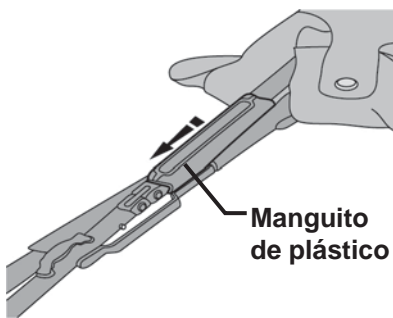

Manguito de plástico

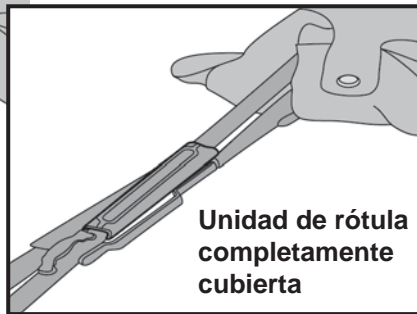

Unidad de rótula completamente cubierta

Deslice el manguito de plástico sobre la unidad de rótula

7

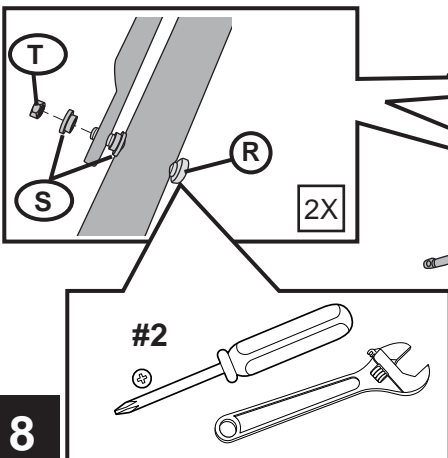

Localice la unidad del arco central. Alinee el agujero con la unidad del arco lateral y asegúrela.

Use un tornillo para metales M5 x 30 con dos (2) cojinetes y una tuerca de Nylock M5.

8

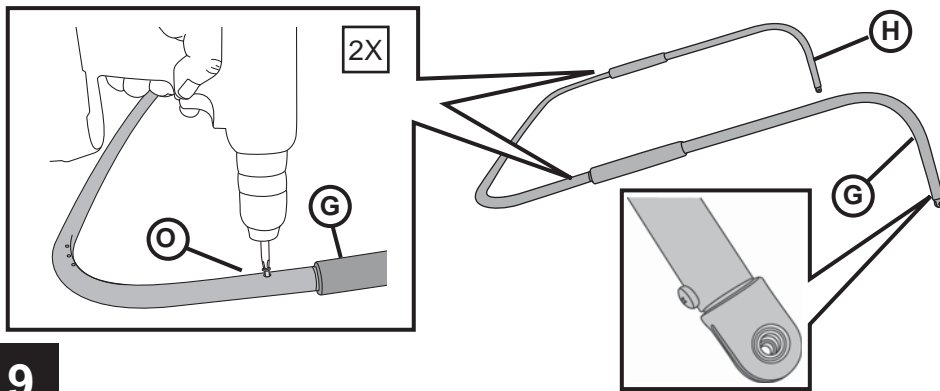

Localisez les arceaux latéraux gauche et droite et orientez-les de manière à ce que les grands trous soient vers l'extérieur.

Fixez-les sur l'arceau arrière à l'aide d'une vis autotaraudeuse n° 8 x 1/2 po de chaque côté.

9

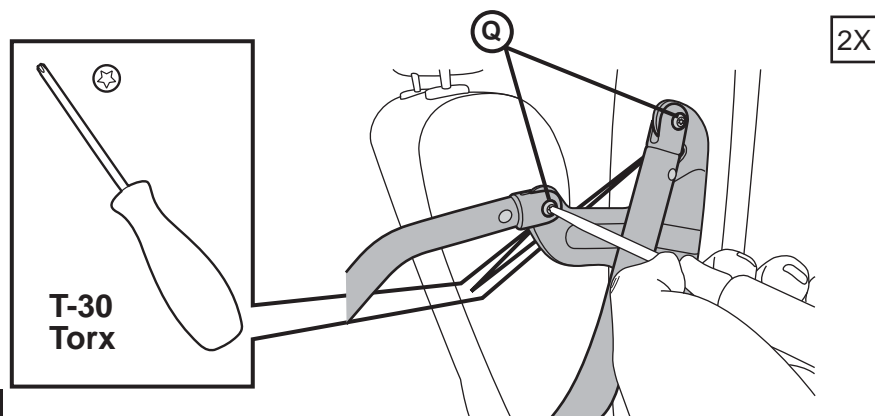

Coloque la Estructura del Techo sobre el vehículo. Utilice los Pernos de Fijación de las Bisagras para fijar el armazón trasero en la Estructura del Techo a las Bisagras de los Bastidores.

10

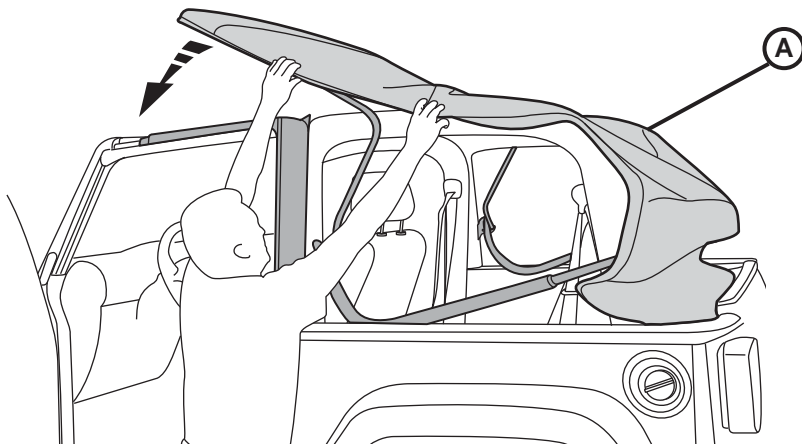

Saque la Estructura del Techo y córrala sobre la cabina del vehículo.

11

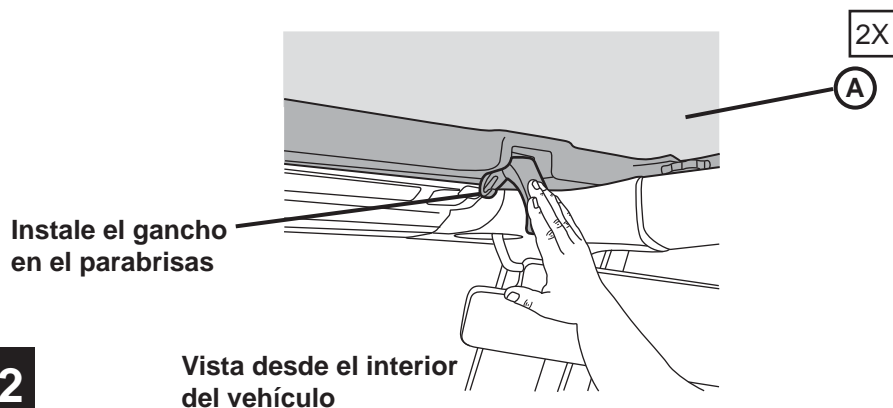

Instale el gancho en el parabrisas

Cierre la parte frontal del Techo y asegúrelo al parabrisas con los ganchos en la cabecera.

12

Vista desde el interior del vehículo

2X

Enrolle el plástico adentro del canal

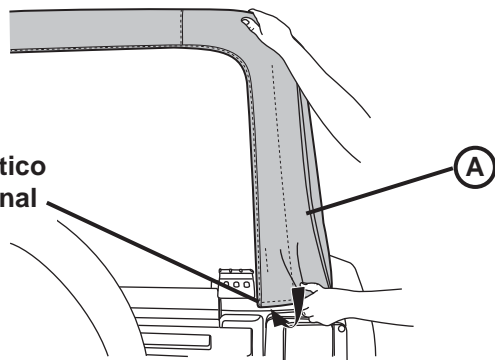

Deslice las tiras plásticas ubicadas en las esquinas traseras del Techo adentro del canal tubular en el vehículo.

13

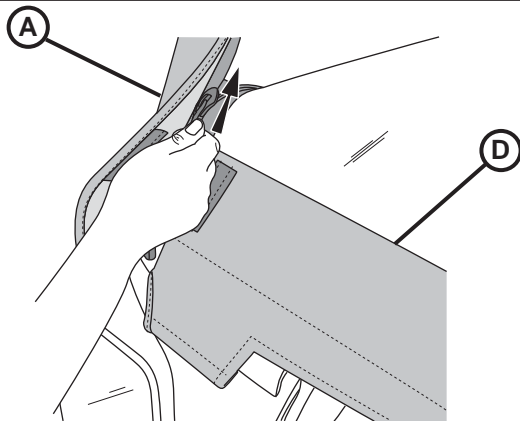

Proceda a cerrar la cremallera en la Ventana Trasera y cierre parte de ese marco.

14

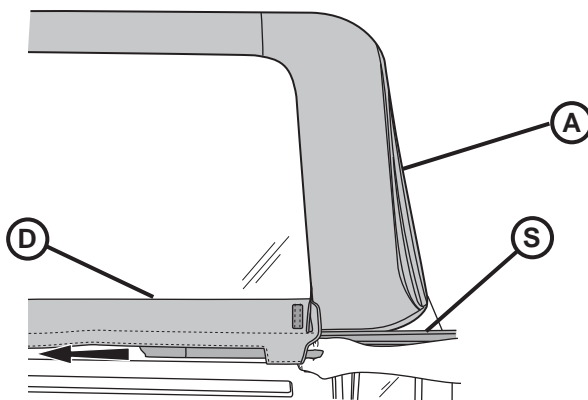

Deslice el canal tubular en la Barra de la Compuerta Trasera sobre el tubular ubicado a lo largo del fondo de la parte de adentro de la Ventana Trasera.

15

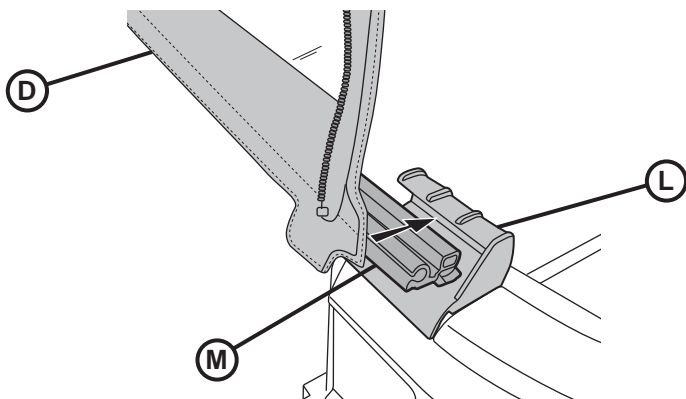

Deslice la Barra de la Compuerta Trasera adentro de los Bastidores de la Compuerta Trasera a cada lado de la abertura de la compuerta trasera.

16

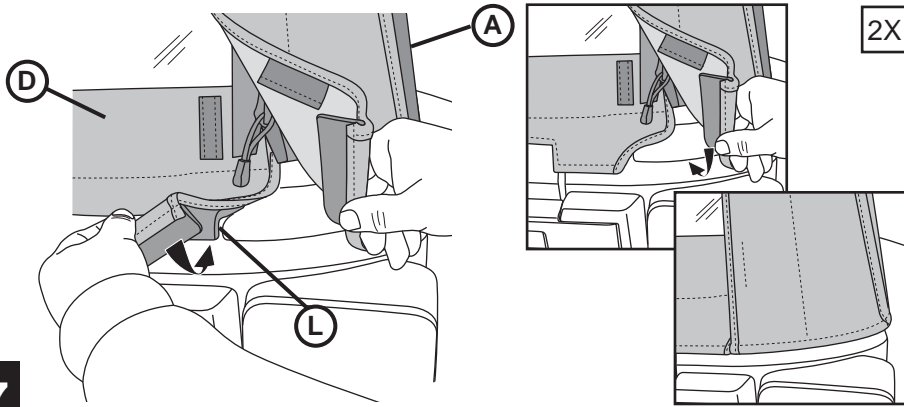

Deslice las tiras plásticas ubicadas en las esquinas traseras del Techo adentro del canal tubular en el vehículo.

17

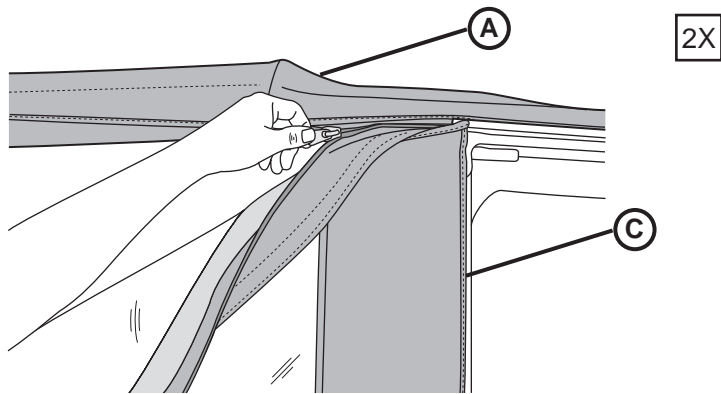

Proceda a cerrar la cremallera ubicada en la Ventana Lateral y ciérrela sólo en 1 ó 2 pulgadas.

18

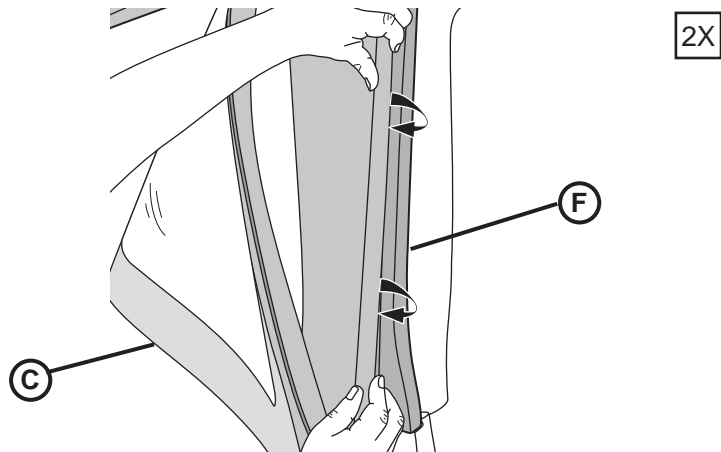

Enrolle la tira plástica ubicada a lo largo de la parte frontal de la Ventana Lateral adentro del canal en el Marco de la Parte Superior de la Puerta.

19

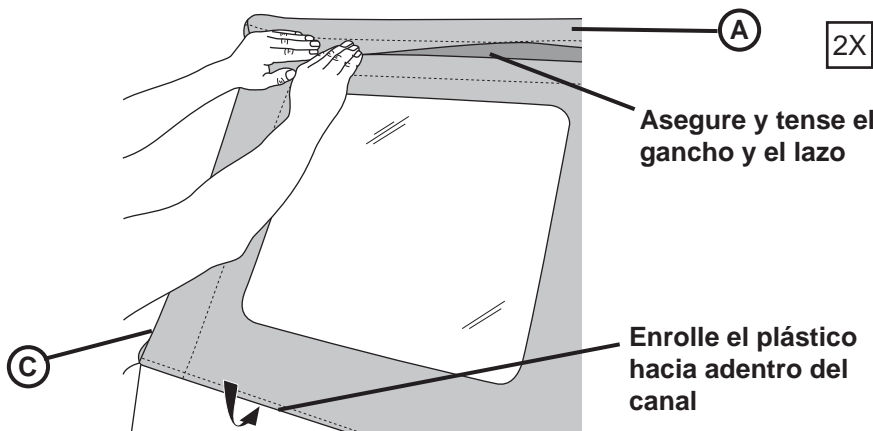

Cierre la cremallera y deslice el plástico a lo largo del fondo de la Ventana Lateral adentro del canal tubular en el vehículo. Asegure y tense el gancho y el lazo que están sobre ventana al techo.

20





# JEEP WRANGLER

## KIT DE TOIT AMOVIBLE POUR MODÈLE 2 PORTES

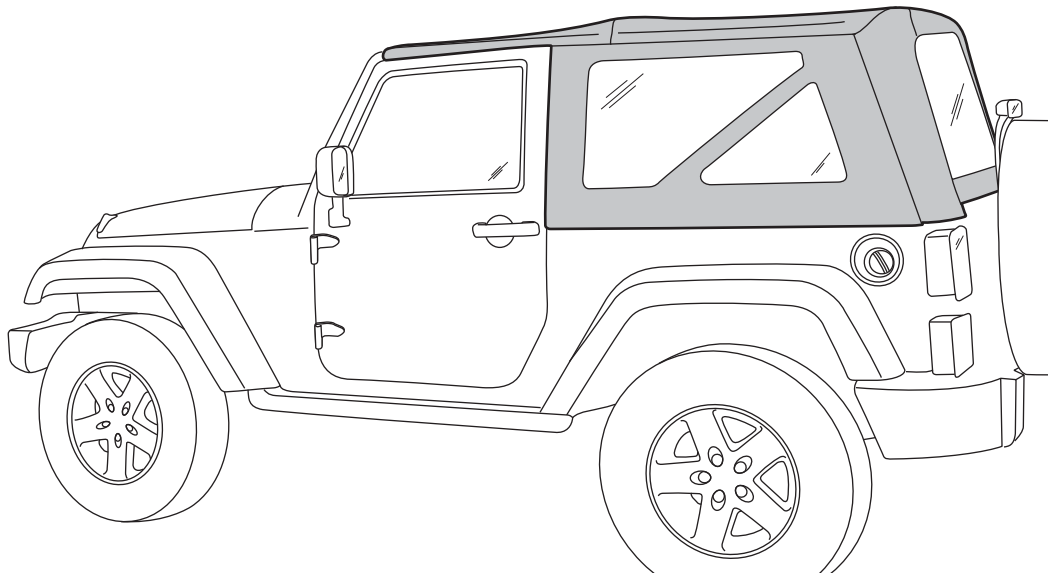

82213649  
82213650

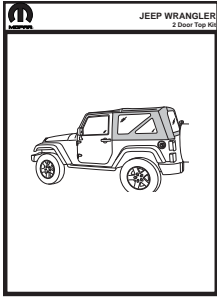

K6861727

**A** 1X

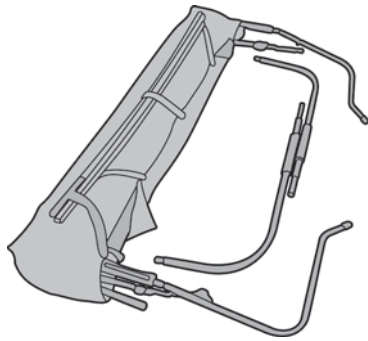

**B** 1X G

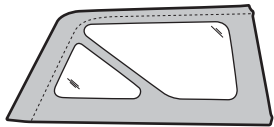
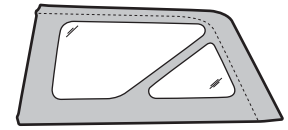

**C** 1X D

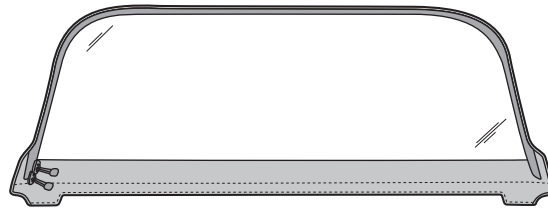

**D** 1X

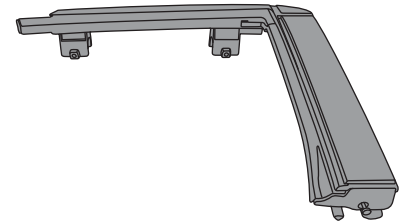

**E** 1X G

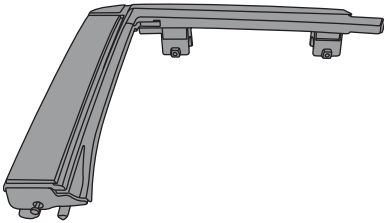

**F** 1X D

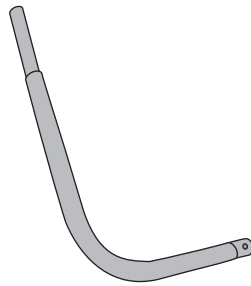

**G** 1X G

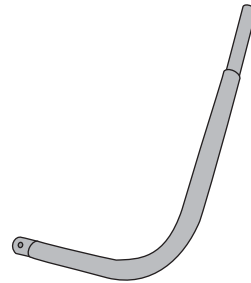

**H** 1X D

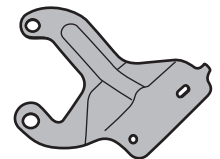

**I** 1X G

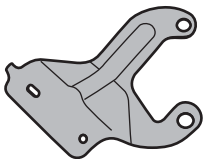

**J** 1X D

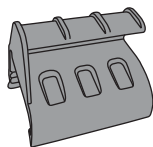

**K** 1X G

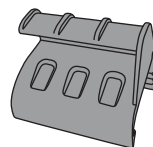

**L** 1X D

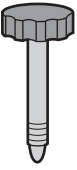
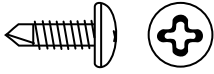
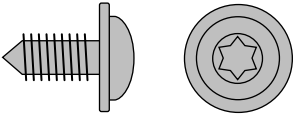
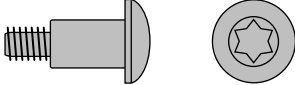
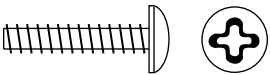
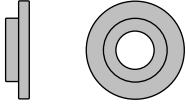
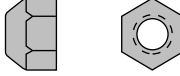
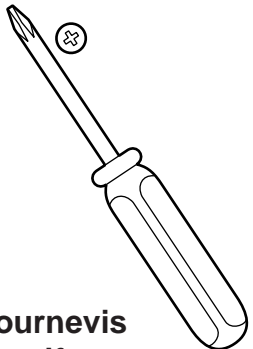
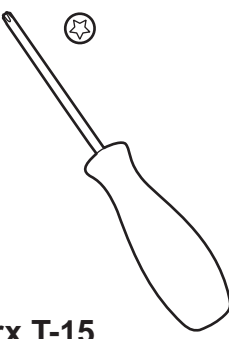
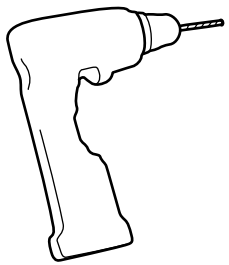
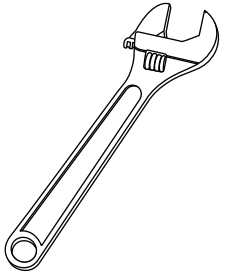
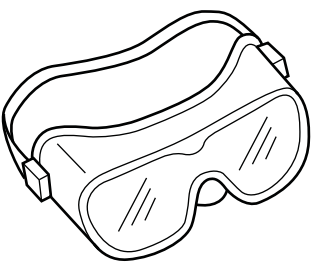

**M** 1X

 <p><b>N</b> 4X</p>	 <p><b>O</b> 2X</p>	 <p><b>P</b> 4X</p>	 <p><b>Q</b> 4X</p>
 <p><b>R</b> 2X</p>	 <p><b>S</b> 4X</p>	 <p><b>T</b> 2X</p>	
 <p><b>Tournevis cruciform Tailles 1, 2 et 3</b></p>	 <p><b>Torx T-15 et T-30</b></p>	 <p><b>Perceuse Foret cruciforme n° 2</b></p>	 <p><b>Clé à molette</b></p>
			

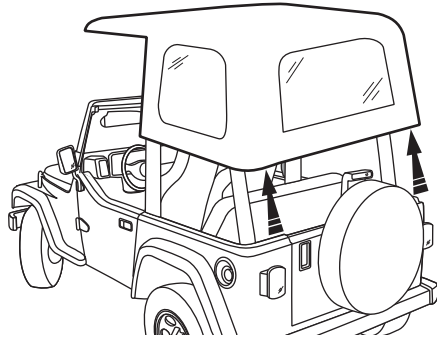

Retirez le toit amovible.  
Reportez-vous au guide  
d'utilisation pour les  
instructions.

1

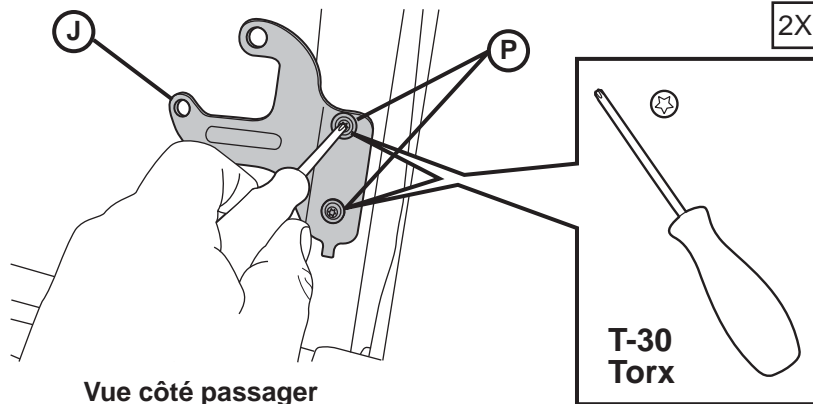

Vue côté passager

Utilisez les vis de sup-  
port pour installer les  
supports de fixation  
pour arceau sur la barre  
sport arrière.

2

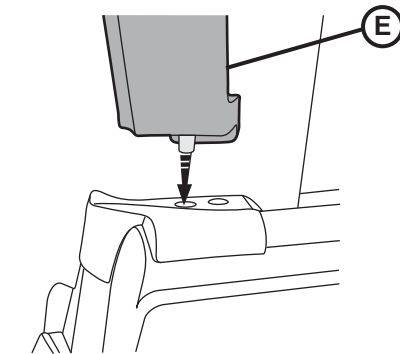

Vue côté conducteur

Localisez les  
encadrements de  
porte gauche et droite.  
Insérez la tige du bas  
de l'encadrement de  
porte dans le trou du rail  
d'arrimage derrière la  
porte.

3

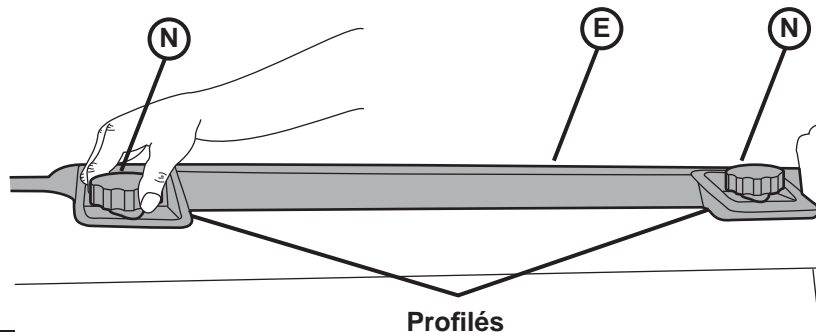

Profils

Vue de l'intérieur au-dessus du côté conducteur

Appuyez les profilés  
sur le dessus de  
l'encadrement de porte  
autour de la barre  
sport horizontale, au-  
dessus de l'ouverture  
de la porte. Insérez  
les boutons dans  
l'encadrement de porte  
et serrez-les en place.

4

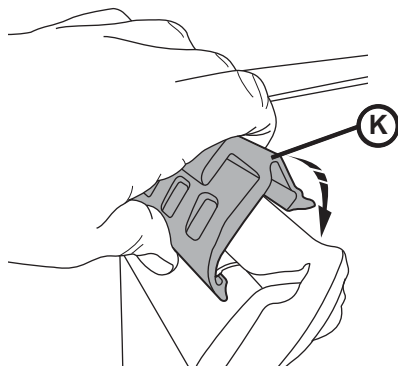

2X

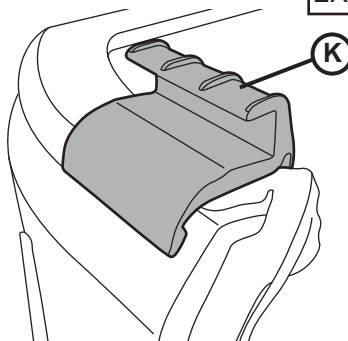

5

Vue côté conducteur

Localisez les montures pour hayon gauche et droite. Orientez-les sur le véhicule. Accrochez le bas de l'une des montures sous le rail d'arrimage et tournez-la vers l'intérieur du véhicule jusqu'à ce qu'elle s'enclenche en place. Répétez cette étape avec l'autre monture pour hayon.

2X

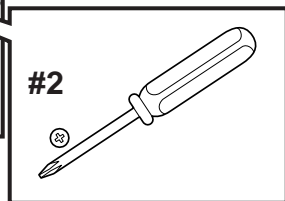
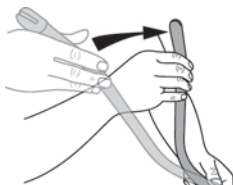
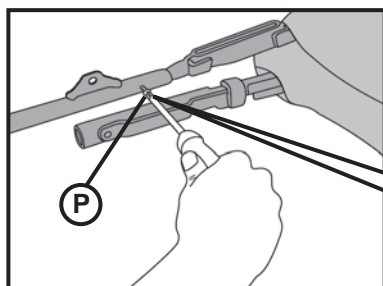

2X

6

Vue côté passager

Faire tourner l'arceau latéral de 90 degrés jusqu'à ce qu'il soit vertical.

Insérer la vis dans le trou existant et serrer à l'aide d'un tournevis à pointe cruciforme.

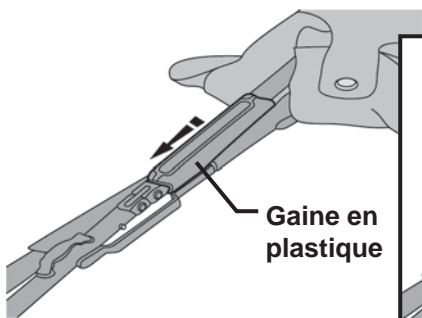

2X

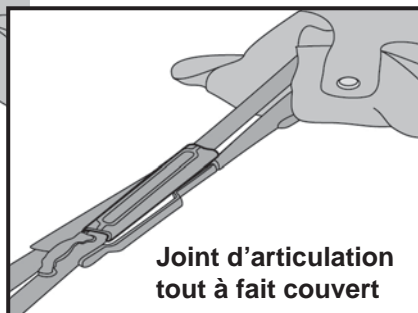

7

Faites glissez la gaine en plastique autour du joint d'articulation.

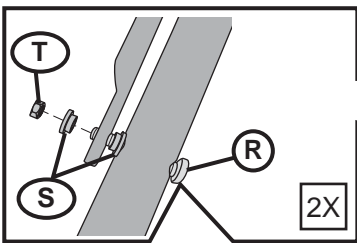

2X

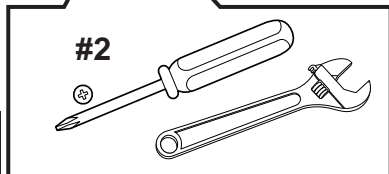

8

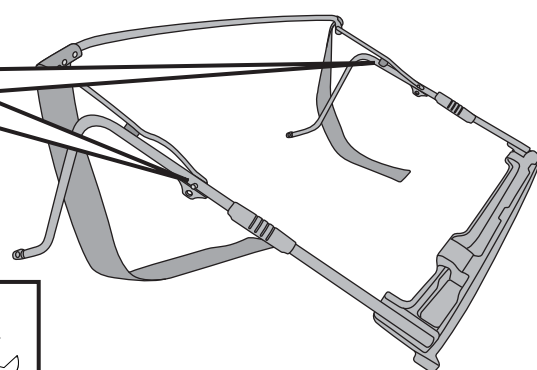

Localiser l'arceau central. Placer le trou vis-à-vis de l'arceau latéral et fixer.

Utiliser une vis mécanique M5 x 30 à l'aide de deux (2) douilles et un écrou à frein élastique M5.

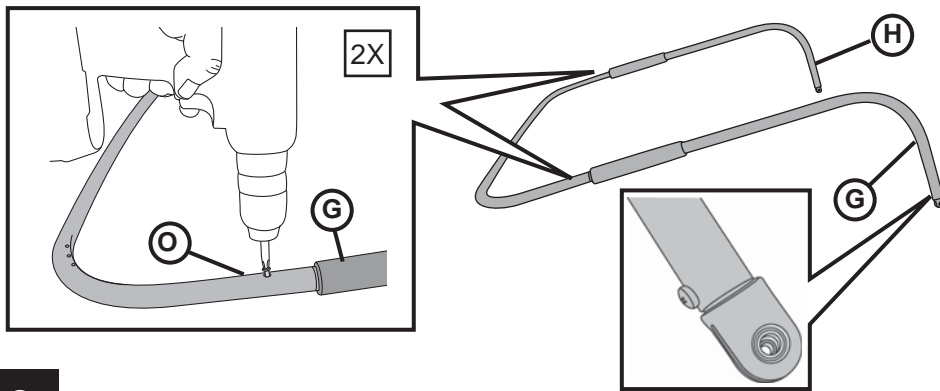

Localisez les arceaux latéraux gauche et droite et orientez-les de manière à ce que les grands trous soient vers l'extérieur.

Fixez-les sur l'arceau arrière à l'aide d'une vis autotaraudeuse n° 8 x 1/2 po de chaque côté.

9

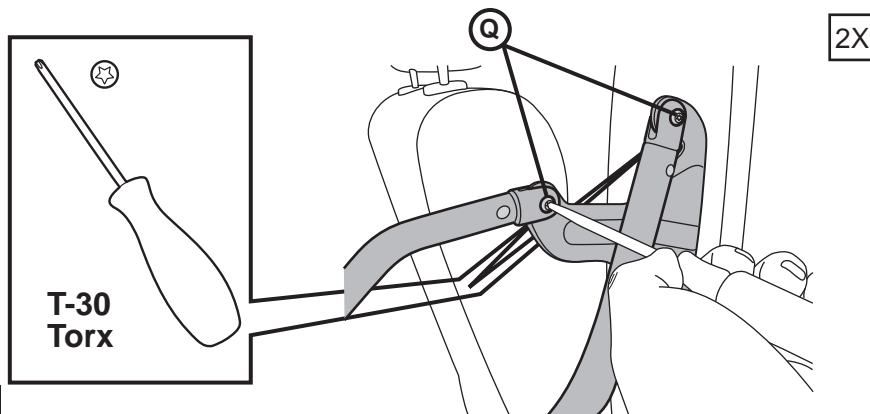

Placez le toit sur le véhicule.

Utilisez des boulons à rotule pivotants pour fixer l'arceau arrière du toit sur les supports de fixation pour arceau.

10

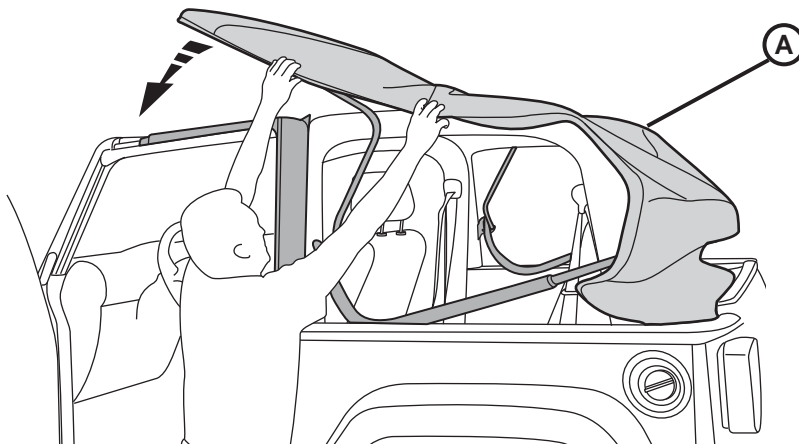

Ouvrez le toit et recouvrez-en la cabine du véhicule.

11

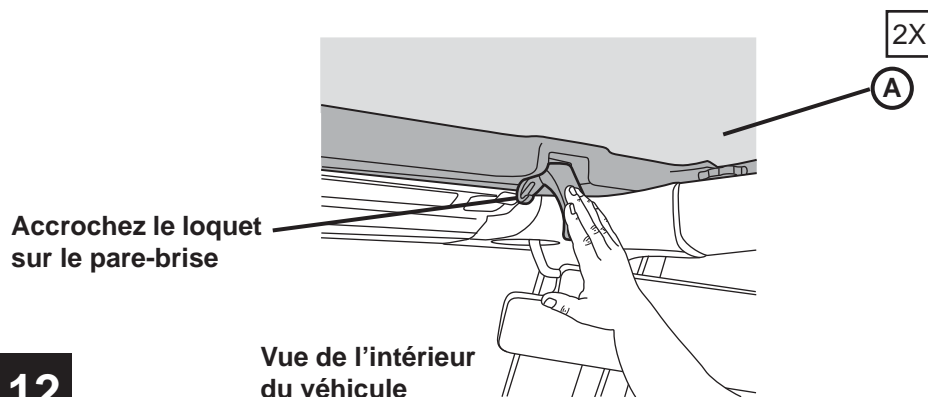

Fermez l'avant du toit et fixez les loquets du toit sur le pare-brise.

12

2X

Enroulez le plastique dans le profilé

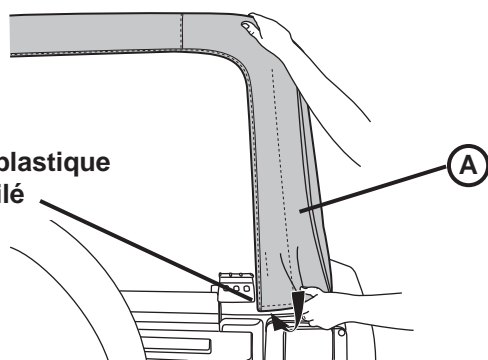

Insérez la languette de plastique dans les coins arrière du toit dans le profilé du véhicule.

13

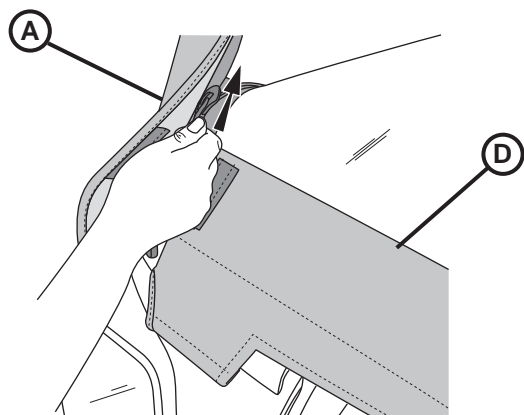

Tirez sur la fermeture à glissière de la fenêtre arrière et fermez-la partiellement sur le pourtour.

14

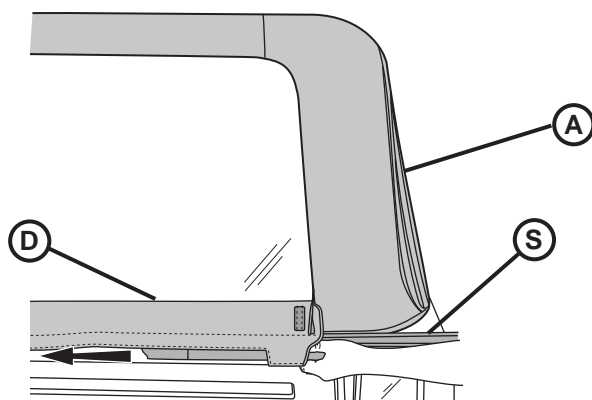

Faites glisser le profilé de la barre de hayon sur la tubulure autour du bas de la fenêtre arrière à l'intérieur.

15

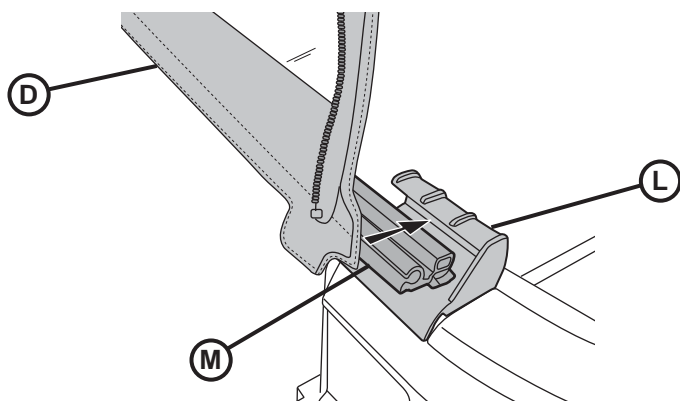

Faites glisser la barre de hayon dans les montures pour hayon de chaque côté de l'ouverture du hayon.

16

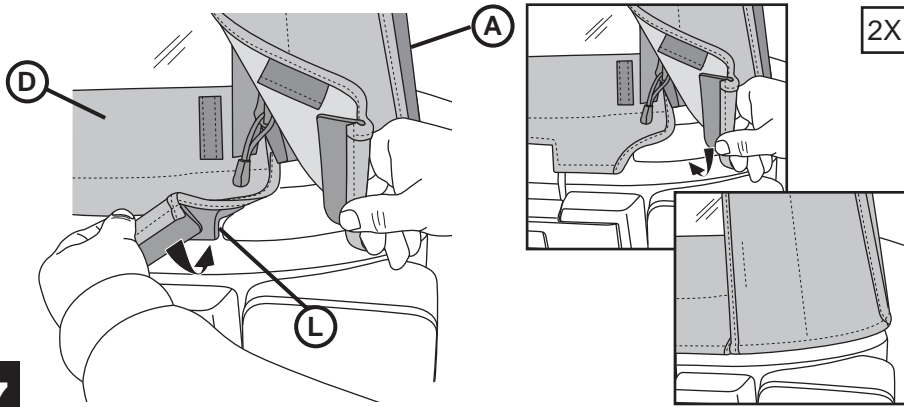

Insérez la languette de plastique dans les coins arrière du toit dans le profilé du véhicule.

17

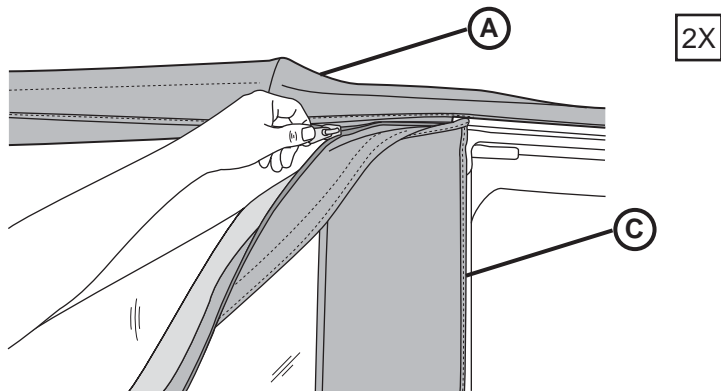

Tirez sur la fermeture à glissière de la fenêtre latérale et fermez-la sur 2,5 à 5 cm (1 à 2 pouces).

18

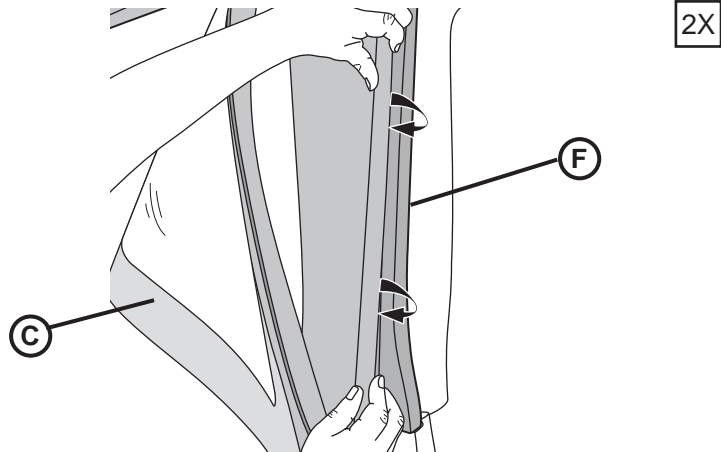

Enroulez la languette de plastique le long de l'avant de la fenêtre latérale dans le profilé de l'encadrement de porte.

19

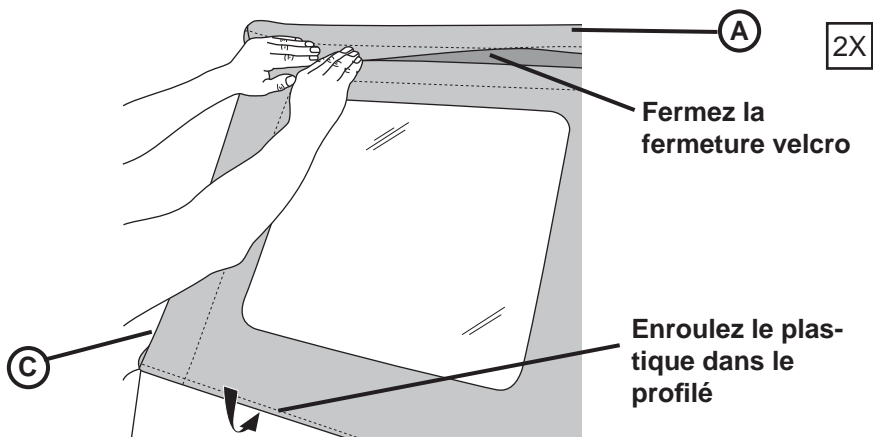

Fermez la fermeture à glissière et faites glisser le plastique le long du bas de la fenêtre latérale dans le profilé du véhicule. Fixez la fermeture velcro au-dessus de la fenêtre sur le toit.

20