

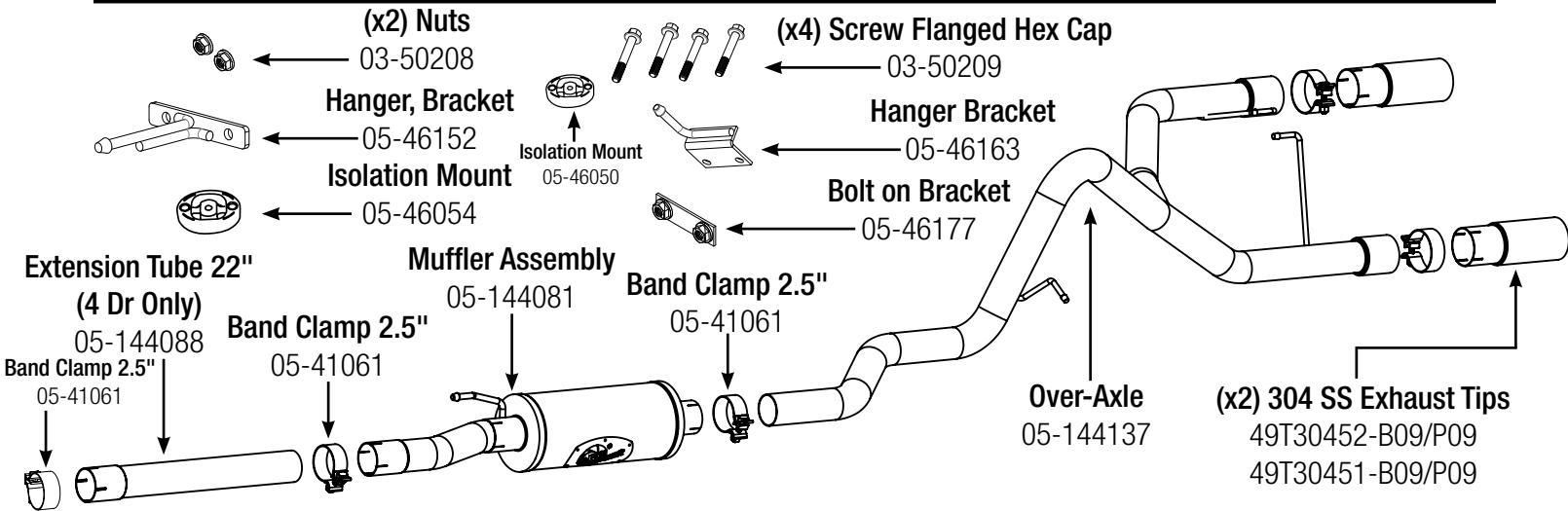

INSTALLATION INSTRUCTIONS

MAKE: Jeep
 MODEL: Wrangler (JK)
 YEAR: 2007-2017
 ENGINE: V6-3.6L/3.8L (2/4 Door)

Cat-Back
409 Stainless Steel
49-48056-B (Black Tips)
49-48056-P (Polished Tips)



Caution: Allow time for your vehicle to cool down prior to installation. When working on or under your vehicle proceed with caution. Exhaust systems reach high temperatures and may cause serious burns. Wear protective safety equipment; eye goggles and gloves to ensure a safe installation.

- Step 1:** Remove your stock exhaust up to the catalytic converters. Remove the (X2) middle bolts on the tow hitch.
- Step 2:** For 4 door Jeeps install the 22" extension tube first using the provided 2.5" band clamp. For 2 door jeeps install the muffler assembly using the provided 2.5" band clamp.
- Step 3:** Install hanger bracket 05-46163/ 05-46117 using the provided isolation mount 05-46050 and bolts 03-50209. **(See Figure "A" for reference.)**
- Step 4:** Install the over axle tailpipe using the provided 2.5" band clamps and OE hanger mount locations.



(Figure A.)



(Figure B.)



- Step 5:** Install hanger bracket 05-46152 using the provided nuts, Bolts, and isolation mount. **(See Figure "B" for reference.)**
- Step 6:** Install tips, Adjust the exhaust system and tighten all clamps and hardware starting from the front and working your way back.
- Step 7:** Congratulations your install is now complete it is recommended to re-check and tighten all clamps and hardware 50-100 miles after installing.

NOTES:

- aFe recommends that the tailpipe be at least 1/2"-1" away from any body panels to avoid heat related body damage. **Tighten and secure.**
- It is normal for your exhaust system to emit smoke for the first few minutes upon initial start-up.

Caution: Allow time for your vehicle to cool down prior to installation. When working on or under your vehicle proceed with caution. Exhaust systems reach high temperatures and may cause serious burns. Wear protective safety equipment; eye goggles and gloves to ensure a safe installation. **aFe recommends professional installation on our products.**