



3651 N Highway 89 • Chino Valley, AZ 86323  
(928) 636-7080 • www.p-a-g.net

# JEEP WRANGLER JEEP WRANGLER UNLIMITED 2 & 4 DOOR 2" BODY LIFT KIT INSTALLATION INSTRUCTIONS 07-11 KIT# 992

## ⚠ WARNING

Installation of a Performance Automotive Group body lift kit will change the vehicle's center of gravity and handling characteristics both on- and off-road. You must drive the vehicle safely! Extreme care must be taken to prevent vehicle rollover or loss of control, which could result in serious injury or death. Avoid sudden sharp turns or abrupt maneuvers and always make sure all vehicle occupants have their seat belts fastened.

## ⚠ WARNING

Before you install this kit, read and understand all instructions, warnings, cautions, and notes in this instruction sheet and in the vehicle owner's manual.

## ⚠ CAUTION

Proper installation of this kit requires knowledge of the factory recommended procedures for removal and installation of original equipment components. We recommend that the factory shop manual and any special tools needed to service your vehicle be on hand during the installation. Installation of this kit without proper knowledge of the factory recommended procedures may affect the performance of these components and the safety of the vehicle. We strongly recommend that a certified mechanic familiar with the installation of similar components install this kit.

## ⚠ WARNING

DO NOT combine suspension, body, or other lift devices. Use of vehicle with combined lifts may result in unsafe and/or unexpected handling characteristics.

## ⚠ WARNING

This kit should only be installed on a vehicle that is in good working condition. Before you install the kit, thoroughly inspect the vehicle for corrosion or deformation of the sheet metal around the factory body mounts. If the vehicle is suspected to have been in a collision or misused, do not install this kit. Off-road use of your vehicle with this kit installed may increase the stress applied to the factory body mounts. We do not recommend that any vehicle with a body lift kit installed be involved in any extreme off-road maneuvers such as jumping. Failure to observe this warning may result in serious personal injury and/or severe damage to your vehicle.

## ⚠ WARNING

Many states and municipalities have laws restricting bumper heights and vehicle lifts. Consult state and local laws to determine if the changes you intend to make to the vehicle comply with the law.

## ⚠ WARNING

The installation of larger tires may reduce the effectiveness of the braking system.

## ⚠ WARNING

Always wear eye protection when operating power tools.

## ⚠ WARNING

Before you install this kit, block the vehicle tires to prevent the vehicle from rolling.

## ⚠ WARNING

Accidental deployment of the air bag can result in serious personal injury or death. To avoid accidental deployment during installation of the kit, the Supplemental Restraint System (SRS, or airbag) must remain deactivated. Do not allow anyone near the airbag during installation. Refer to the factory service manual or owner's manual for the recommended procedure to disable the SRS. After you install the kit, reactivate the SRS before driving the vehicle.

## NOTE

Performance Automotive Group recommends using the Loctite® supplied in the kit on the threads of all kit nuts and bolts unless specified otherwise in these instructions.

# Before Starting Installation

## NOTE

Kit parts are prefaced by the word *kit* and appear in **bold** print.

1. Carefully read all warnings and instructions completely before beginning.
2. Verify all parts have been received in this kit by checking the parts list at the end of this document.

## NOTE

If parts are missing from kit, please be prepared to provide the following information:

1. **Name** of purchase location
2. **Bar Code** on side of box
3. **Date** above bar code
4. **Date** inside box cover
5. **Inspector #** from inside box cover

3. **Only install this kit on the vehicle for which it is specified.** If anytime during the installation you encounter something different from what is outlined in the instructions, call technical support at (928) 636-7080.
4. Park vehicle on a clean, dry, flat, level surface and block tires so vehicle cannot roll in either direction.

## Engine Compartment

1. Disconnect both battery cables. Disconnect negative cable first, then positive cable.

Positive Cable                      Negative Cable



## 2. Airbag Fuse

## NOTE

The location of the airbag fuse may vary; check the owner's manual.

- a. Remove fuse cover.
- b. Remove airbag fuse.

Fuse Block

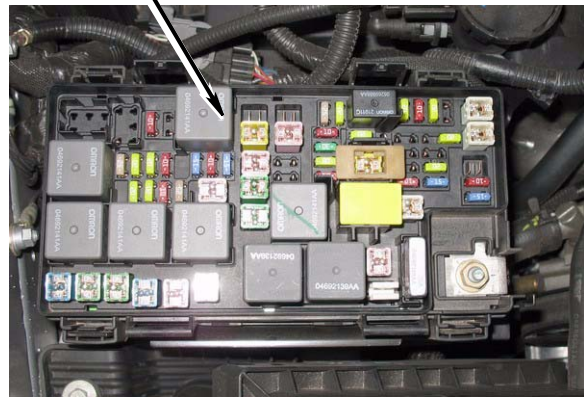

# Prepare to Install Kit

## Front of Vehicle

### 1. Grille

- a. Unplug wire harness from two fog lamps. Slide out red tab and disconnect wire harness.

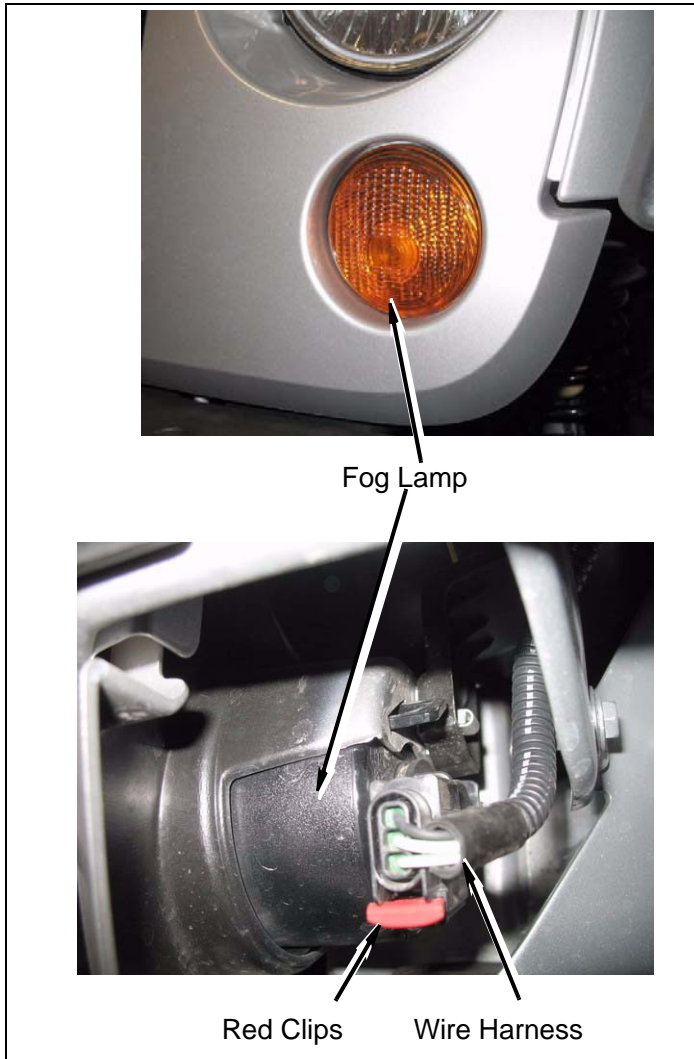

- b. Remove six screw clips along top of grille.

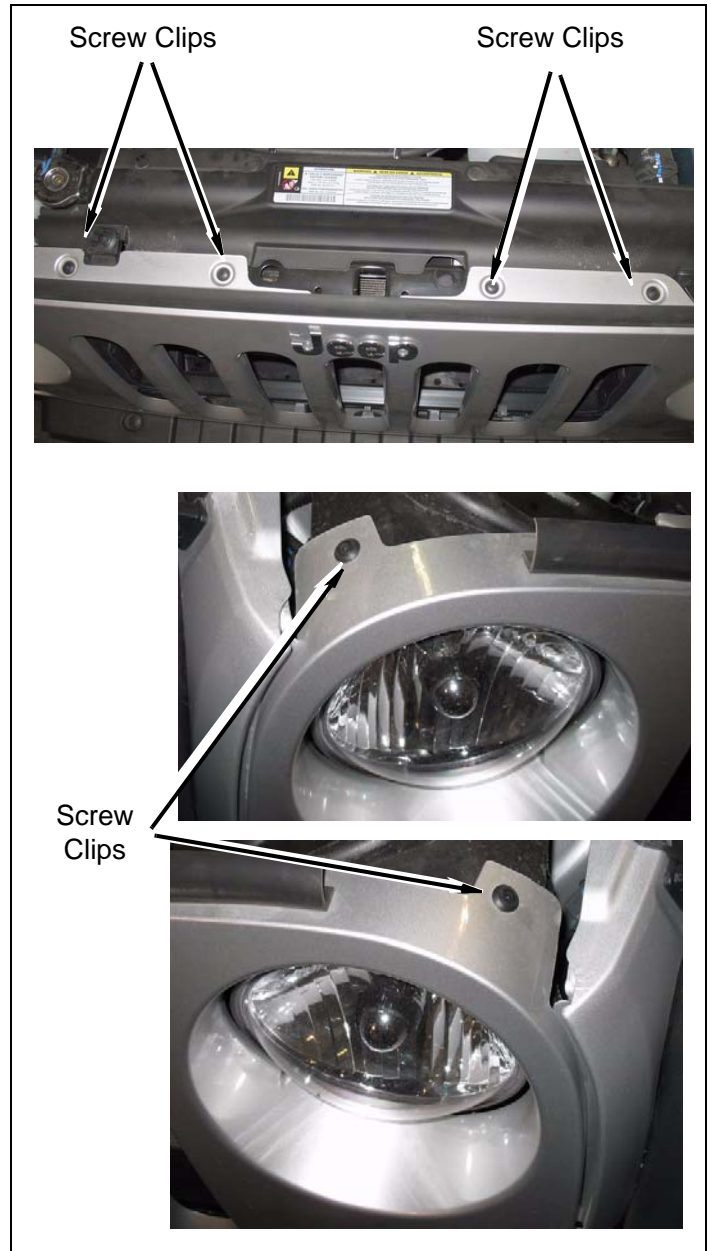

- c. Remove grille from vehicle by popping four clips along bottom of grille.

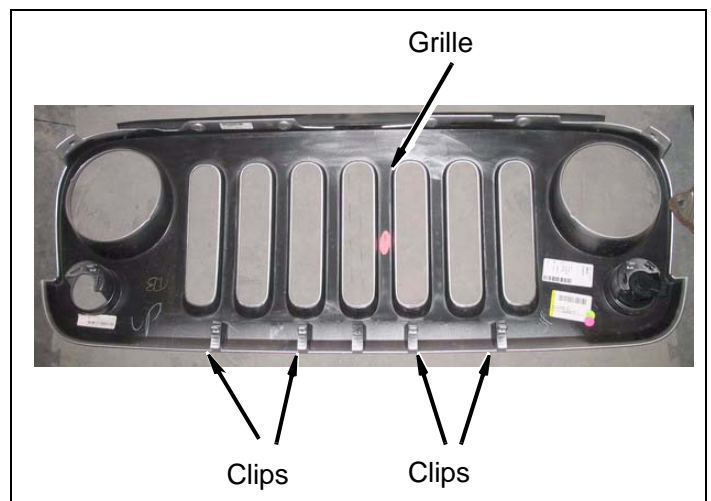



## Engine Compartment

### 1. Wire Harness

- Unclip wire harness on firewall at back of engine.

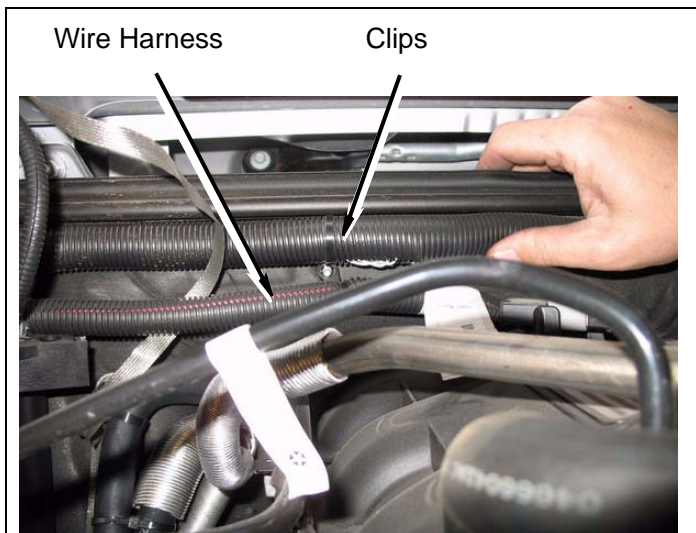

### 2. Steering Shaft

#### ⚠ WARNING

Accidental deployment of the air bag can result in serious personal injury or death. To avoid accidental deployment during installation of the lift kit, the Supplemental Restraint System (SRS, or airbag) must remain deactivated. Do not allow anyone near the airbag during installation. Refer to the factory service manual or owner's manual for the recommended procedure to disable the SRS. After kit installation, the SRS must be reactivated before driving the vehicle.

#### ⚠ CAUTION

If the following step is not performed, the airbag clock-spring could be damaged. Do not turn the steering wheel while the steering shaft is disconnected.

- Strap steering wheel to prevent accidental movement.

- Mark steering shaft u-joint in relation to steering shaft as shown.

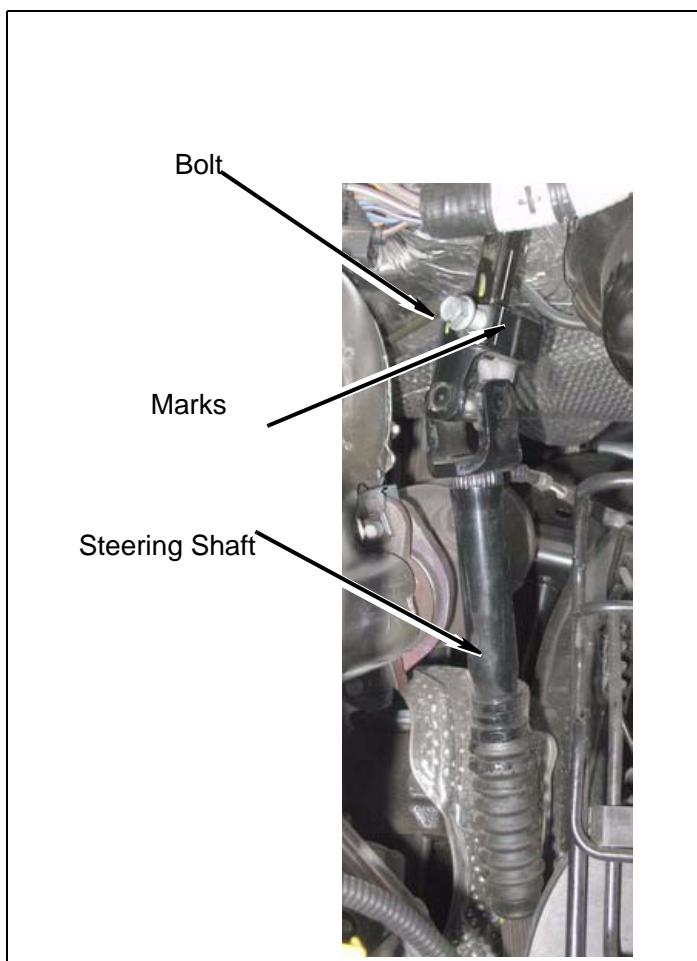

- Remove bolt and slide u-joint off of steering shaft.

## Install Kit

### Body

- Prepare to lift body from frame

a. Remove two nuts on front core support body mount on driver side.

c. Remove two nuts on front core support body mount on passenger side.

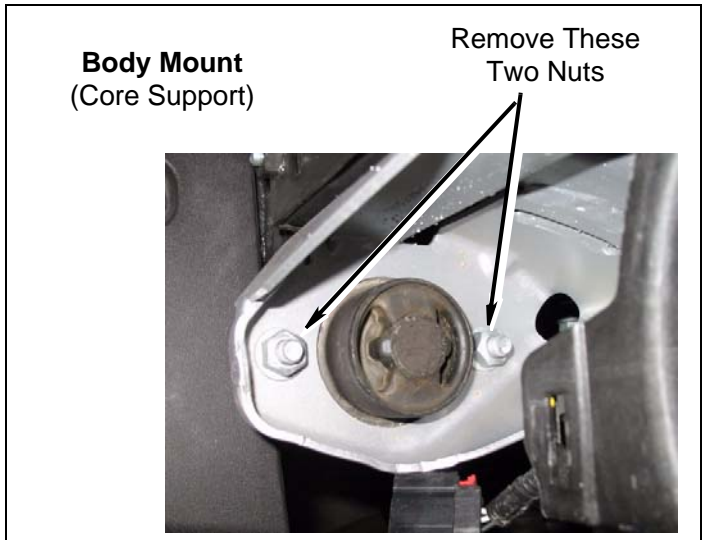
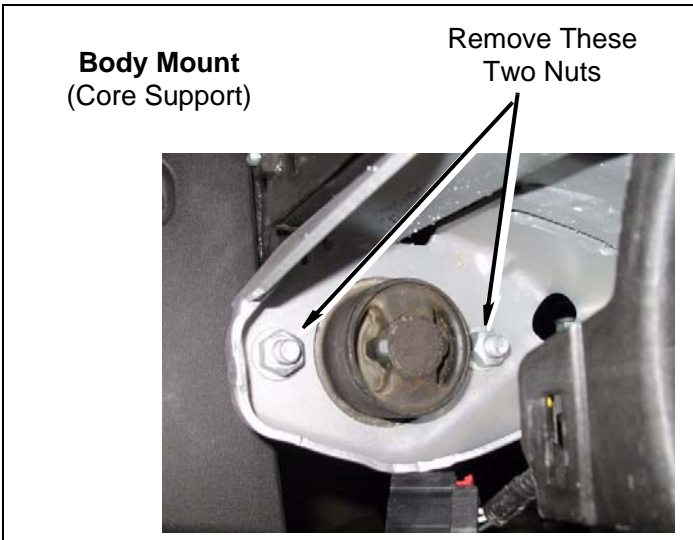

b. **Driver Side:** Loosen, but DO NOT REMOVE, body mounting bolts. **2 Door** - 4 body mount bolts and **4 Door** - 5 body mount bolts.

d. **Passenger Side:** Remove bolt and lower bushing from each cab mount on passenger side. **2 Door** - 4 body mount bolts and **4 Door** - 5 body mount bolts.

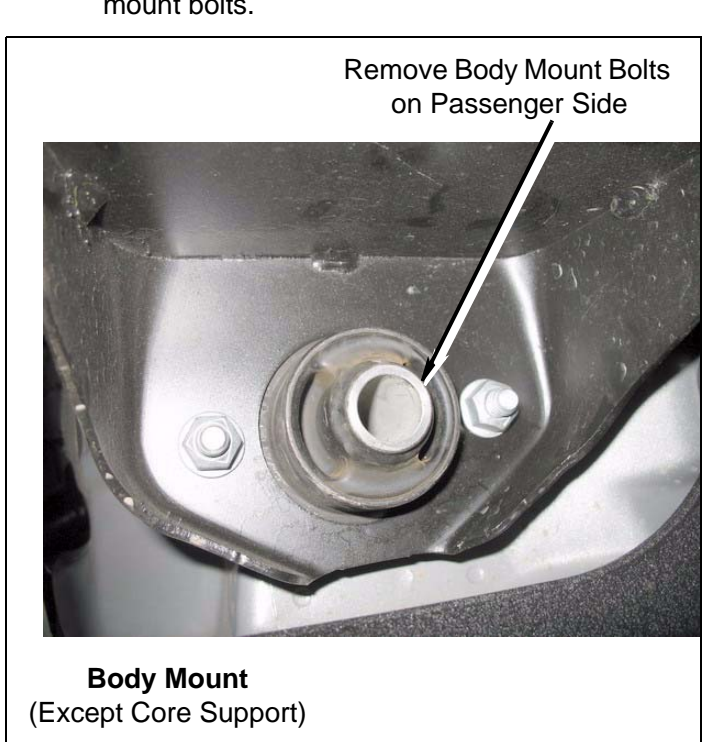
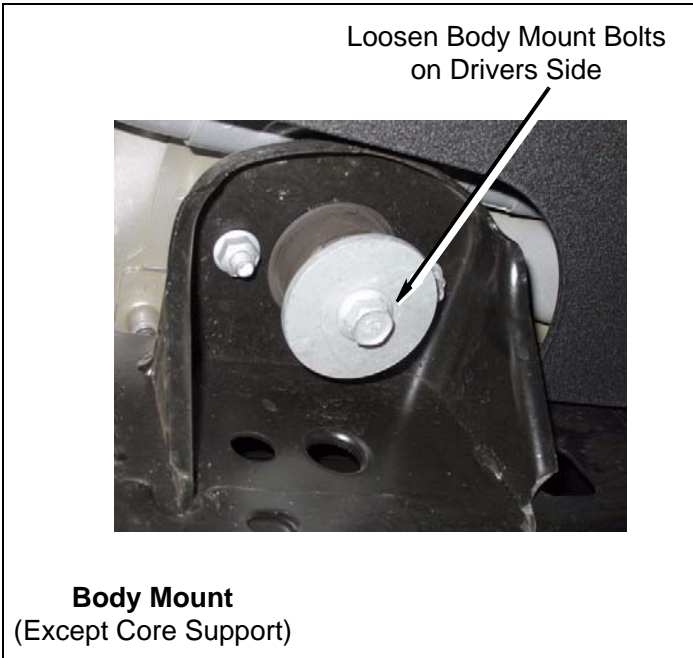

**NOTE**  
The number of body mounting bolts may vary depending if vehicle is a 2 door or 4 door.

- e. Remove large washer from factory bolts by supporting large washer and tapping on the bolt.

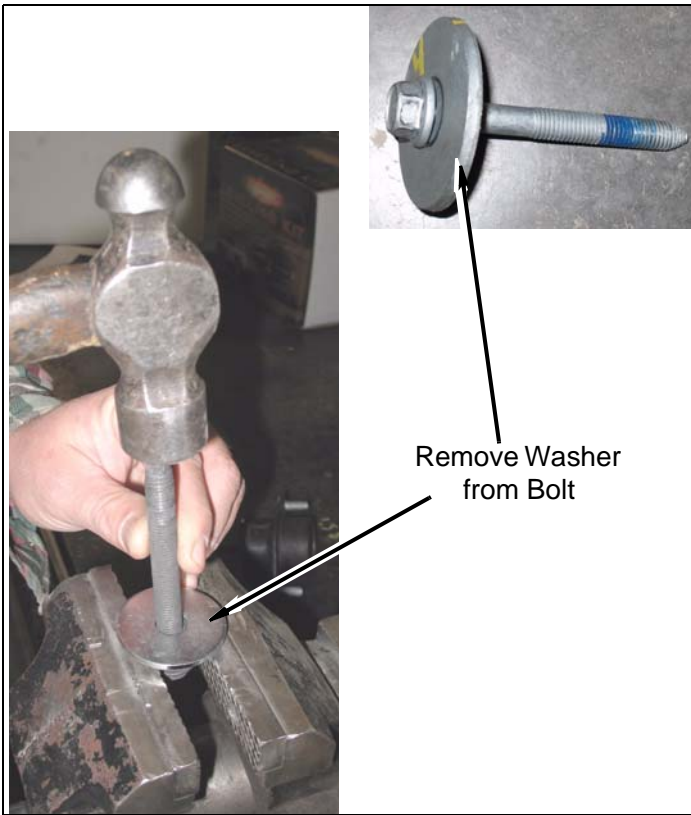

- b. Remove bottom nut on front core support mount.

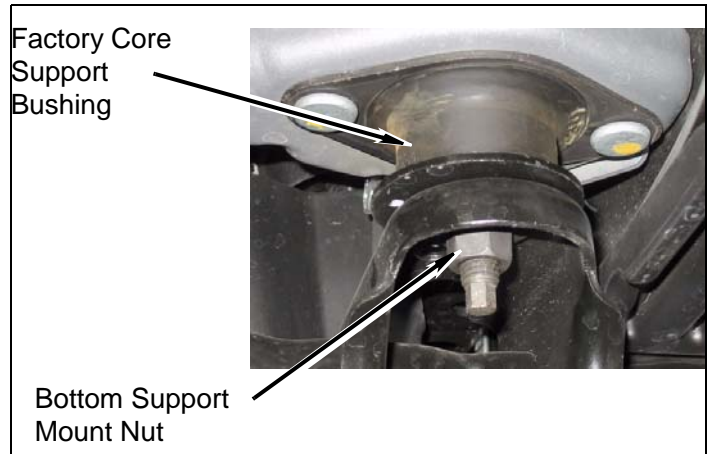

- c. Remove core support bushing from vehicle.
- d. Remove the two bolts from core support mount by tapping on them with a hammer.

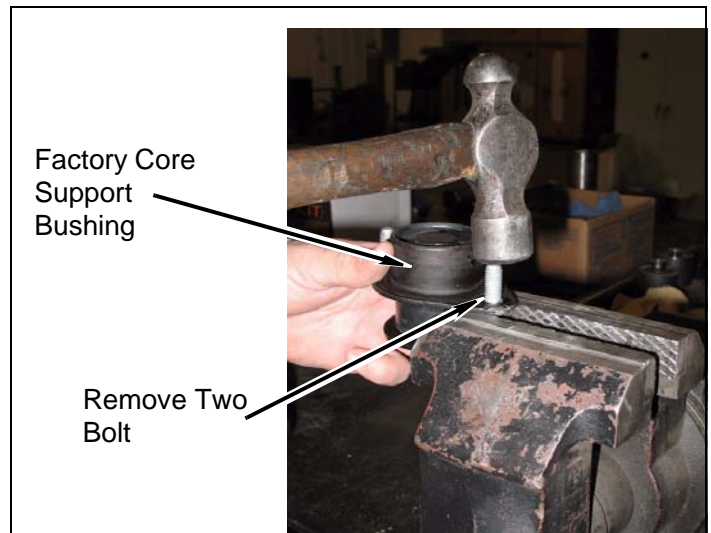

- e. Place *kit block* (core support) on core support mount.

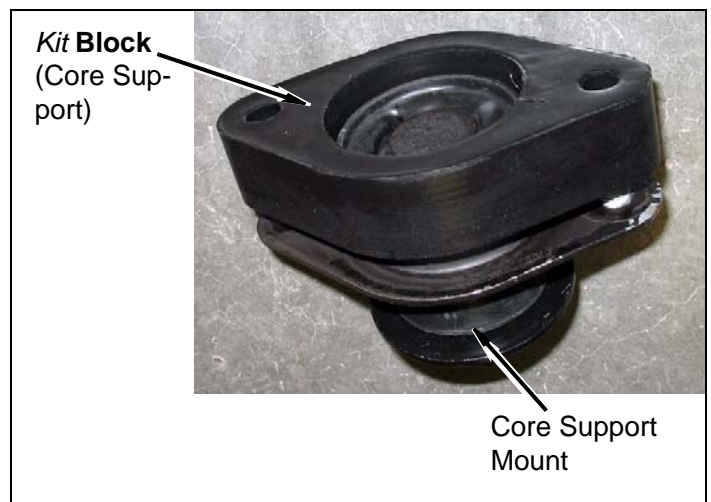

**⚠ WARNING**

Use extreme caution when lifting body from frame. To prevent serious personal injury, ensure the lifting device is securely placed. Keep your hands out from between the body and frame.

**⚠ CAUTION**

Continually check hoses, wires, lines, etc. to be sure that everything is flexing properly and not binding, or damage to the vehicle could result. Be especially careful of the a/c hoses at the fire wall, the belt pulley, and at the core support. Ensure brake lines stretch while lifting. Bending the lines to gain ample slack may be necessary. Be extremely careful not to kink the lines.

**2. Passenger side**

- a. Position a hydraulic floor jack and a wood block under passenger side of body (under the body seam). Slowly lift body just enough to install a **kit block** on top of factory upper bushing.

**⚠ WARNING**

The **kit blocks** must be installed in addition to the factory upper and lower bushings. Installing the **kit blocks** without the factory upper and lower bushings could result in damage to the vehicle or serious personal injury.



- f. Install four **kit washers** (10 mm), two **kit bolts** (10 mm x 50 mm), two nuts (10 mm) and core support mount on vehicle.

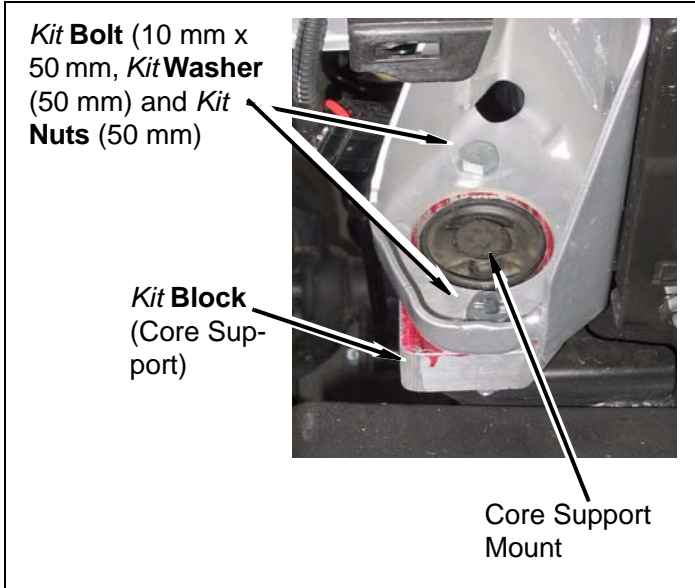

- g. Install **kit blocks** (1" x 3") onto factory body bushings on each body mount.

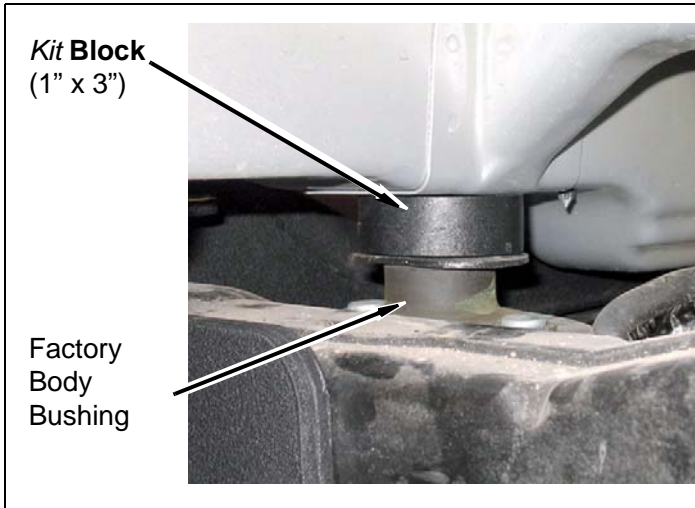

- h. Lower body onto **kit blocks** (1" x 3").

**3. Install kit bolts.**

- a. **2007 only!** Install **kit bolt** (12mm-1.75 x 140mm) and factory large washer on each body mount. **DO NOT TIGHTEN.**
- b. **2008 only!** Install **kit bolt** (12mm-1.75 x 140mm) all body mounts **EXCEPT** rear most two. Install two **kit bolt** (14mm-2.0 x 140mm) in two rear most body mounts. Use factory large washer on each body mount. **DO NOT TIGHTEN.**

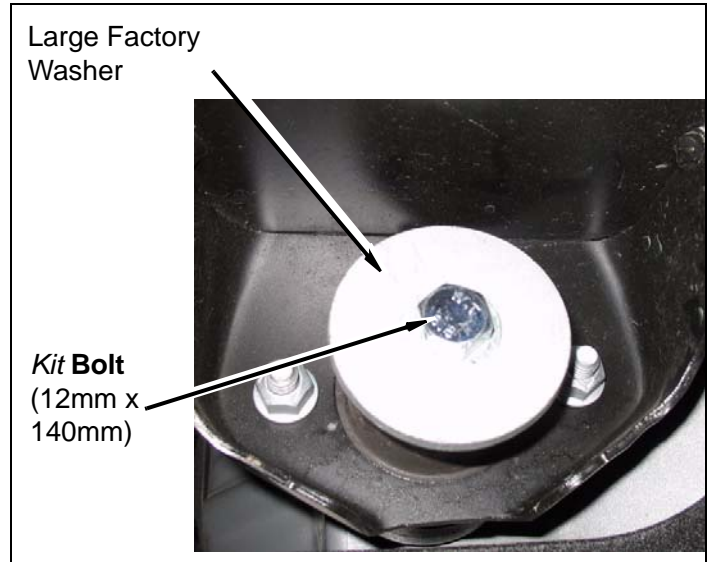

- c. Unclip vent hose on passenger side just in front of last body mount.

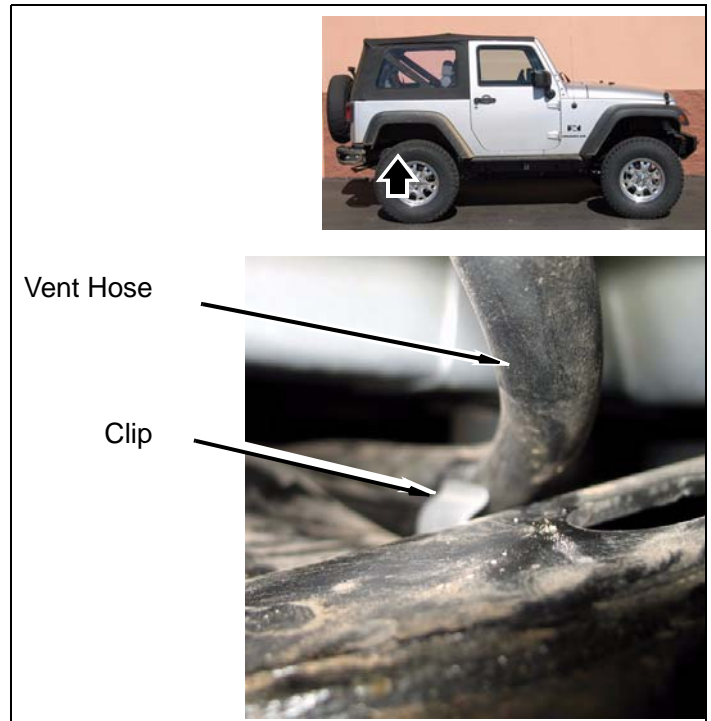

**4. Cab driver side**

- a. Repeat previous steps on driver side of vehicle.
- b. Remove each *kit bolt*, one at a time, and apply a small amount of *kit Loctite*® onto threads. Install *kit bolt* (12mm-1.75 x 140mm), and lower bushing. TIGHTEN *kit bolts*.

- c. Apply a small amount of *kit Loctite*® onto factory bolt and *kit 3/8" x 1 1/4" bolt* and tighten to 33 lb.-ft.

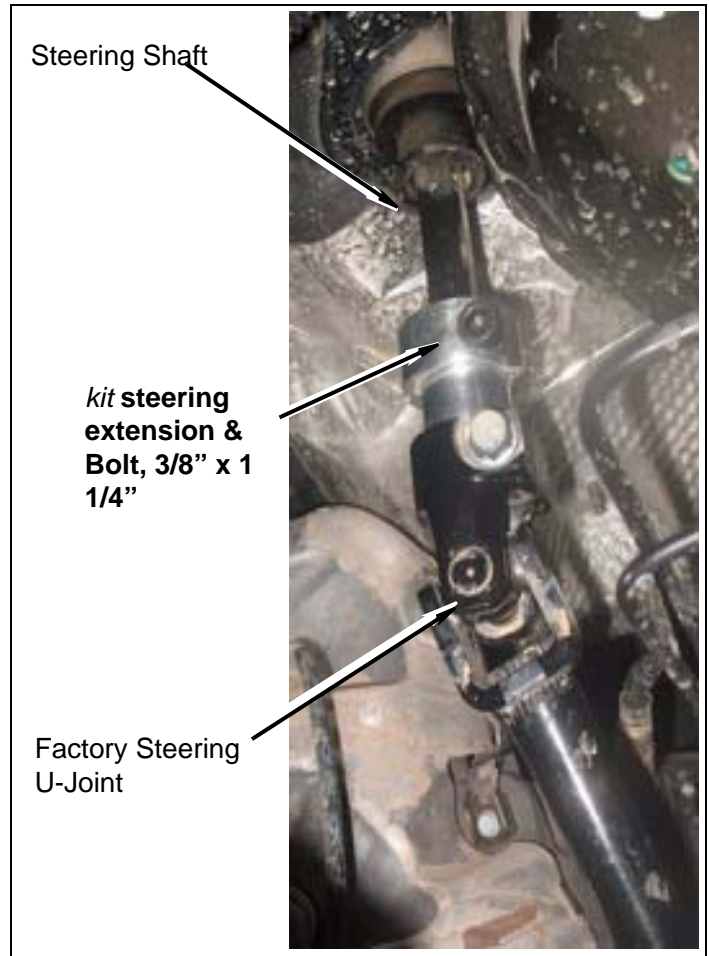
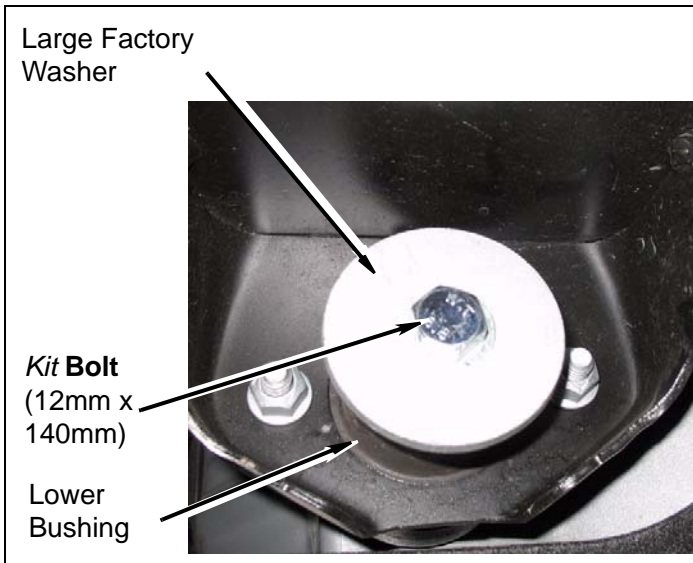

## Engine Compartment

1. Install *kit steering extension*

### ⚠ WARNING

Verify the steering shaft is securely installed as specified in the instructions. Failure to do so may cause steering malfunction, resulting in property damage or serious personal injury.

### ⚠ WARNING

Accidental deployment of the air bag can result in serious personal injury or death. To avoid accidental deployment during installation of the lift kit, the Supplemental Restraint System (SRS, or airbag) must remain deactivated. Do not allow anyone near the airbag during installation. Refer to the factory service manual or owner's manual for the recommended procedure to disable the SRS. After kit installation, the SRS must be reactivated before driving the vehicle.

- a. Slide *kit steering extension* onto shaft sticking through firewall.
- b. Slide u-joint of steering shaft onto *kit steering extension*.

2. Wire Harness

- a. Clip wire harness on firewall at back of engine.

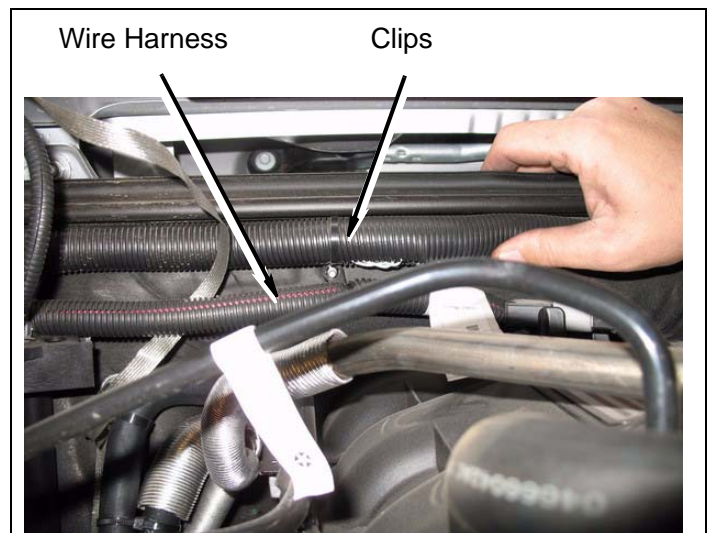



## Front of Vehicle

### 1. Grille

- a. Install grille on vehicle by popping four clips along bottom of grille.

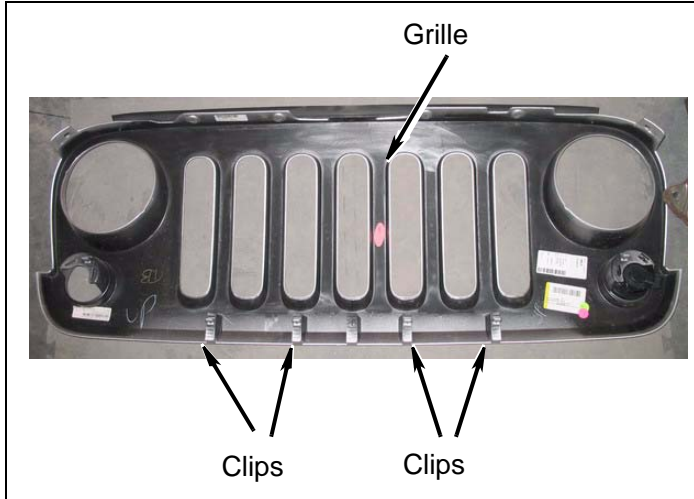

- b. Install six screw clips along top of grille.

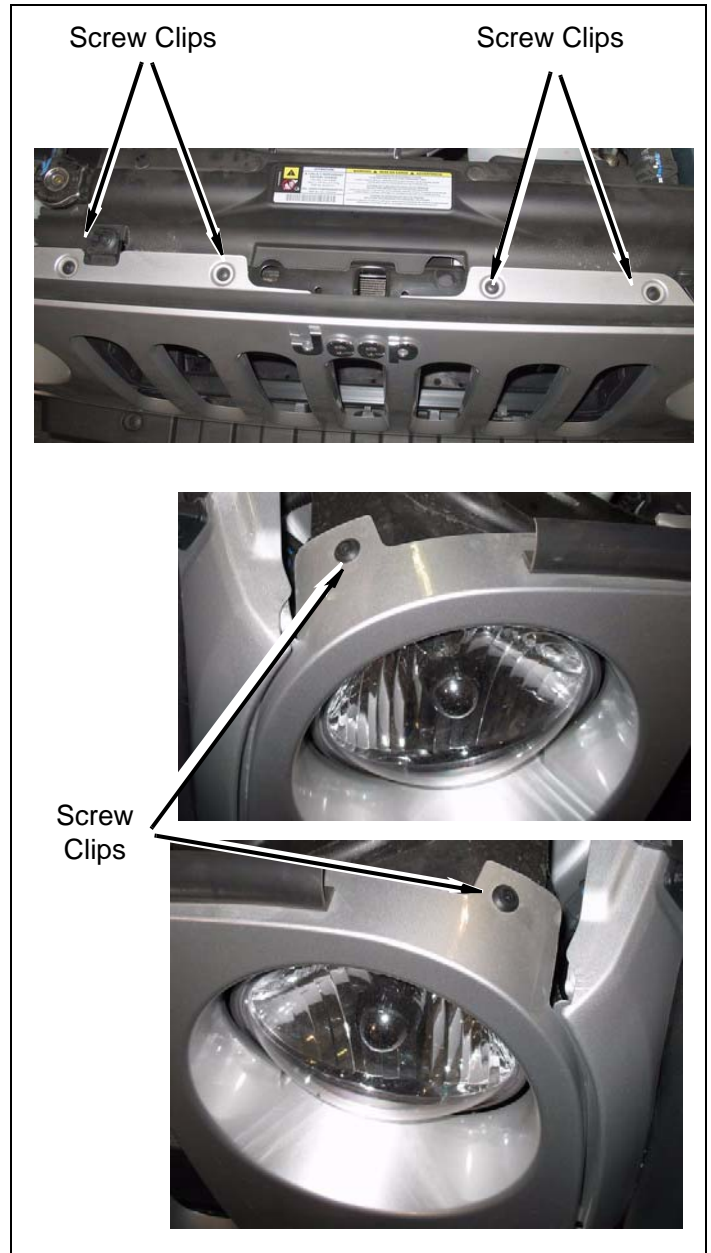

- c. Connect wire harness on two fog lamps. Slide in red tab.

- b. Install airbag fuse cover.

## After Completing Installation

### Engine Compartment

1. Connect both battery cables. Connect positive cable first, then negative cable.

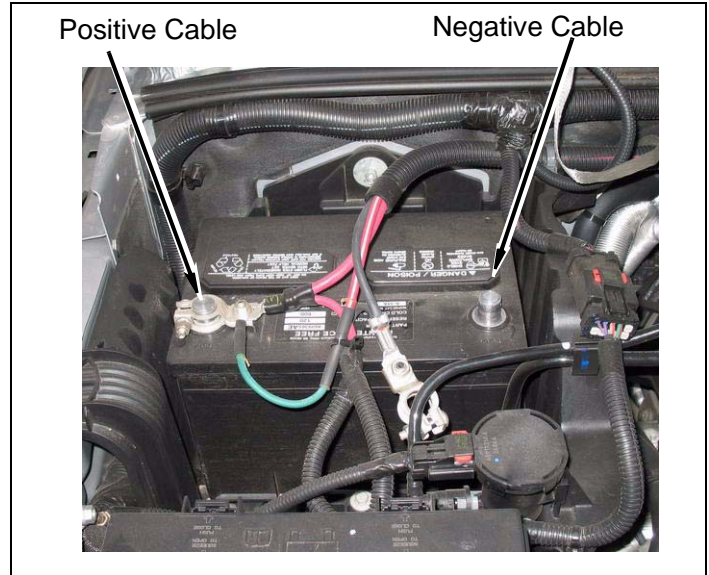

### Miscellaneous

1. Apply **kit label** (warning) onto dashboard in plain sight of all vehicle occupants.
2. Check all fasteners to ensure they are tight.
3. Ensure all wires, hoses, cables, etc. are properly connected and there is ample slack.
4. Adjust headlights

### Dynamic Vehicle Check

1. Check steering in both directions to ensure that there is no bind. Check operation of clutch, brake system, and parking brake. Check operation of transmission and transfer case. Ensure there is full engagement in all gears and 4WD ranges. Check

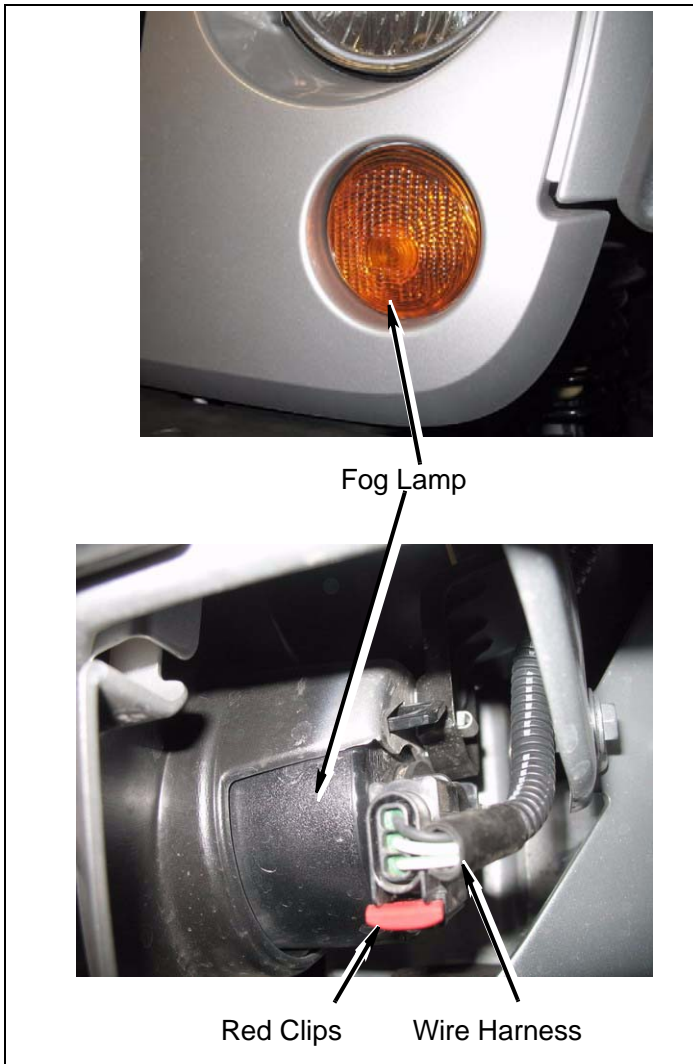

2. Airbag Fuse

**NOTE**  
The location of the airbag fuse may vary; check the owner's manual.

- a. Install airbag fuse

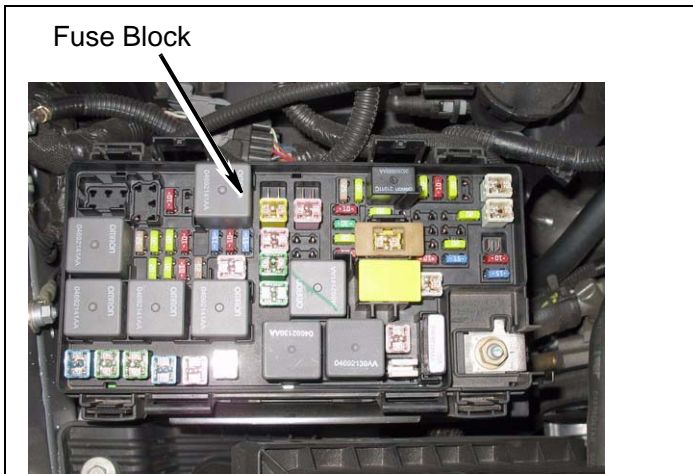

battery connections and electrical component operations. Test-drive vehicle.

**⚠ WARNING**

Retorque all fasteners after 500 miles and after off road use. All body lift components should be visually inspected and fasteners retorqued during routine vehicle servicing.

**⚠ CAUTION**

Performance Automotive Group does not recommend any particular wheel and tire combinations for use with its body lifts and cannot assume responsibility for the customer's choice of wheels and tires. Refer to your owner's manual for recommended tire sizes and warnings related to the use of oversized tires. Larger wheel and tire combinations increase stress and wear on steering and suspension components, which leads to increased maintenance and higher risk for component failure. Larger wheel and tire combinations also alter speedometer calibration, braking effectiveness, center of gravity, and handling characteristics. Consult an experienced local off road shop to find what wheel and tire combinations work best with your vehicle.

**NOTE**

All warranty information, instruction sheets, and other documents regarding the installation of this product must be retained by the vehicle owner. Information contained in the instructions and on the warranty card will be required for any warranty claims. The vehicle owner needs to understand the modifications made to the vehicle and how they affect vehicle handling and performance. Failure to provide the customer with this information can result in damage to the vehicle and severe personal injury.

**NOTE**

Depending on the vehicle configuration (automatic or manual transmission, 2WD or 4WD, cab length, bed length, etc.), some parts may not be used.

## KIT PARTS LIST

**Qty. Description**

- 10 **Block**, Body Lift (2" x 3")
- 2 **Spacer**, Front Mount
- 1 **Steering Extension**
  
- 1** **XXXX (Hardware bag kit)**
- 2 **Bolt**, (14mm x 160mm)
- 10 **Bolt**,(12 mm x 160 mm)
- 4 **Bolt**, (10 mm x 70 mm)
- 4 **Washer**, (10 mm)
- 1 **Bolt**, (3/8" x 1-1/4" socket head)





## GAP GUARD INSTALLATION INSTRUCTIONS.

### ⚠WARNING

Read and understand all instructions, warnings, cautions, and notes in this sheet before you begin gap guard installation.

Always wear eye protection when operating power tools.

### ⚠NOTE

No two vehicles have holes spaced identically. If you are stretching a hole on the gap guard too much, punch another hole with a 1/4" paper punch. Most stock guards mount from the inside, but our gap guards mount from the outside. Kit parts are prefaced by the word *kit* in italics.

### A. Before you start.

1. Read all warnings and instructions completely and carefully before you begin.
2. Check to make sure the kit is complete (refer to the Parts List).
3. Only install this kit on the vehicle for which it is intended.
4. Park the vehicle on a clean, dry, flat, level surface and block tires so the vehicle cannot roll in either direction.
5. Remove and discard stock gap guards from wheel wells.

### B. Install the kit.

1. To install this kit you will need:
  - Drill
  - 1/4" drill bit
2. Front.

- a. Locate *kit* gap guard marked 6909-1.
- b. At driver side front wheel well, position *kit* gap guard to cover side of engine compartment.
- c. Mark a top hole and drill if necessary with a 1/4" drill bit.
- d. Install *kit* plastic fastener through *kit* gap guard and into the wheel well.
- e. Check alignment and mark next hole while keeping *kit* gap guard snug.
- f. Proceed with steps d. and e. until *kit* gap guard is installed
- g. Repeat steps b. through f. for front passenger side/*kit* gap guard marked 6909-2
- h. Position front bumper gap guard in place as shown. 6909-6



### 3. Rear.

- a. Locate *kit* gap guard marked 6909-3.
- b. At driver side rear wheel well, position *kit* gap guard in wheel well and mark first hole to be drilled.
- c. If necessary drill hole with 1/4" drill bit, insert *kit* plastic clips through *kit* gap guard and press into hole in wheel well.
- d. Realign *kit* gap guard in wheel well, mark and drill the next hole. Insert *kit* plastic clips.
- e. Repeat steps c. and d., keeping *kit* gap guard snug.
- f. Repeat steps b. through e. for rear passenger side/*kit* gap guard marked 6909-4.

- g. Position front bumper gap guard in place as shown. 6909-5



### C. Kit Parts List.

Qty	Description
1	Driver front gap guard (6909-1)
1	Passenger front gap guard (6909-2)
1	Driver rear gap guard (6909-3)
1	Passenger rear gap guard (6909-4)
1	Rear bumper cover (6909-5)
1	Front bumper cover (6909-6)
1	Package plastic clip fastener



PO Box 3450 • Chino Valley, AZ 86323  
(928) 636-7080 • www.p-a-g.net

## JEEP WRANGLER 2/4 DOOR 4WD 2007-2009 INSTALLATION INSTRUCTIONS

### 1.75" LEVELING KIT# JL175 .75" LEVELING KIT# JL075

#### ⚠ WARNING

Installation of a Performance Automotive Group suspension lift kit will change the vehicle's center of gravity and handling characteristics both on- and off-road. You must drive the vehicle safely! Extreme care must be taken to prevent vehicle rollover or loss of control, which could result in serious injury or death. Avoid sudden sharp turns or abrupt maneuvers and always make sure all vehicle occupants have their seat belts fastened.

#### ⚠ WARNING

Before you install this kit, read and understand all instructions, warnings, cautions, and notes in this instruction sheet and in the vehicle owner's manual.

#### ⚠ CAUTION

Proper installation of this kit requires knowledge of the factory recommended procedures for removal and installation of original equipment components. We recommend that the factory shop manual and any special tools needed to service your vehicle be on hand during the installation. Installation of this kit without proper knowledge of the factory recommended procedures may affect the performance of these components and the safety of the vehicle. We strongly recommend that a certified mechanic familiar with the installation of similar components install this kit.

#### ⚠ WARNING

This kit should only be installed on a vehicle that is in good working condition. Before you install the kit, thoroughly inspect the vehicle for corrosion or deformation of the sheet metal. If the vehicle is suspected to have been in a collision or misused, do not install this kit. Off-road use of your vehicle with this kit installed may increase the stress applied to the factory components. Failure to observe this warning may result in serious personal injury and/or severe damage to your vehicle.

#### ⚠ WARNING

Many states and municipalities have laws restricting bumper heights and vehicle lifts. Consult state and local laws to determine if the changes you intend to make to the vehicle comply with the law.

#### ⚠ WARNING

The installation of larger tires may reduce the effectiveness of the braking system.

#### ⚠ WARNING

Always wear eye protection when operating power tools.

#### ⚠ WARNING

Before you install this kit, block the vehicle tires to prevent the vehicle from rolling.

#### ⚠ WARNING

DO NOT combine suspension, body, or other lift devices. Use of vehicle with combined lifts may result in unsafe and/or unexpected handling characteristics.

#### NOTE

Lift height may vary depending on vehicle configuration, engine size, additional accessories, the factory suspension package, and vehicle's condition.

#### NOTE

Performance Automotive Group recommends using the Loctite® supplied in the kit on the threads of all kit nuts and bolts unless specified otherwise in these instructions.

#### ⚠ WARNING

We strongly recommend using the Performance Automotive Group shocks that were engineered to be used with this system. If you use other shocks, they must match the full extended and full collapsed lengths of the Performance Automotive Group units exactly. The use of longer or shorter shocks than recommended may cause damage to the vehicle suspension and could result in sudden loss of control of the vehicle and personal injury. Contact Performance Automotive Group for the lengths of the front and rear shocks that must be used with this suspension system.

#### NOTE

Installation of a suspension lift will change the driveline angles which may cause a noticeable vibration in the vehicle.



# Before Starting Installation

**NOTE**  
 JL175 and JL075 installations are identical. The only difference is the thickness of the spacer. Please follow directions for both kits.

**NOTE**  
 Kit parts are prefaced by the word *kit* and appear in **bold** print.

1. Carefully read all warnings and instructions completely before beginning.
2. Verify all parts have been received in this kit by checking the parts list at the end of this document.
3. **Only install this kit on the vehicle for which it is specified.** If anytime during the installation you encounter something different from what is outlined in the instructions, call technical support at (928) 636-3175.
4. Park vehicle on a clean, dry, flat, level surface and block tires so vehicle cannot roll in either direction.

**NOTE**  
 Adhere to recommendations when replacement fasteners, retainers and keepers are called out in the factory service manual. When re-assembling the vehicle it is recommended by the vehicle manufacturer that certain fasteners are replaced in order to maintain proper retention characteristics. This system may not include all replacement hardware as recommended by the factory service manual. Additional replacement hardware should be obtained prior to installation of this system to meet the requirements of the factory service manual.

5. Measure ride height with the vehicle supporting its own weight on level ground. To settle the suspension, the vehicle should be driven forward at least 10 feet immediately prior to taking these measurements. Ride height is the measurement from the

center of the axle straight up (vertical) to the fender lip. Record this measurement for all four wheels.

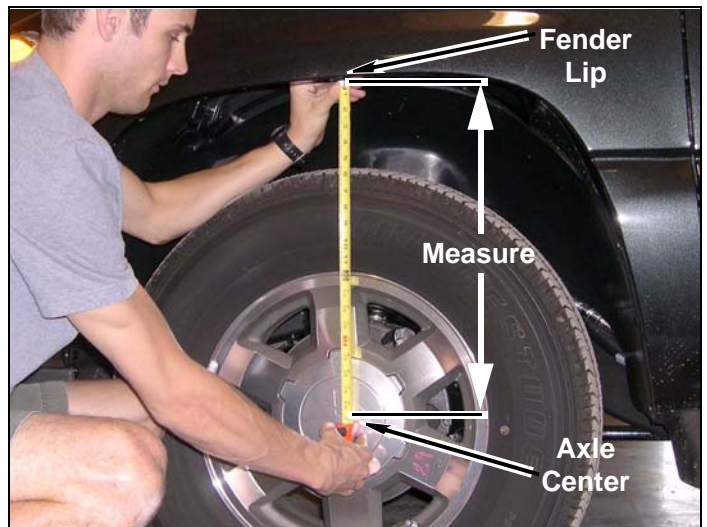

## Wheel & Tire Requirements

The factory wheel and tire combination will fit once this kit is installed.

## Torque Specifications

See factory service manual for torque values when re-using OE fasteners.

<b>Bolt Size</b>	<b>Grade 5 (ft.-lbs.)</b>	<b>Grade 8 (ft.-lbs.)</b>
1/4"-20	10	10
1/4"-28	10	12.5
5/16"-18	17	22.5
5/16"-24	20	25
3/8"-16	30	40
3/8"-24	35	45
7/16"-14	50	65
7/16"-20	55	70
1/2"-13	75	100
1/2"-20	55	70
9/16"-12	105	135
9/16"-18	115	150
5/8"-11	150	195
5/8"-18	160	210
3/4"-16	175	225

## Engine Compartment

1. Disconnect both battery cables. Disconnect negative cable first, then positive cable.

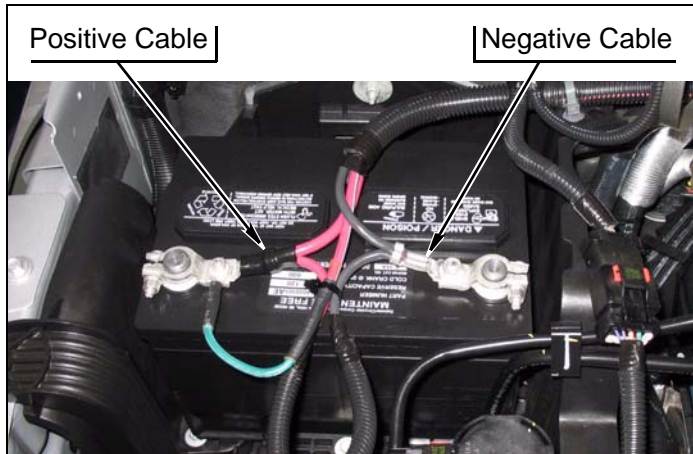

## Prepare to Install Front Suspension

### ⚠ WARNING

Compressed coil springs can expand violently causing serious personal injury. Before removing the coil springs, lower the axle housing as far as possible to allow the coil springs to expand.

1. Loosen, but do not remove, lug nuts on each front wheel.
2. Using a hydraulic floor jack, slowly lift front axle until front tires are 3-5" off ground. Position jack stands under frame behind lower control arm perches. Lower vehicle onto jack stands while maintaining hydraulic jack pressure underneath front axle.

### ⚠ WARNING

Use extreme caution when lifting vehicle from ground. To prevent serious personal injury, ensure the lifting device is securely placed.

3. Remove lug nuts and front wheels from vehicle.

4. Remove two lower bolts, two nuts and two front shock absorbers from axle.

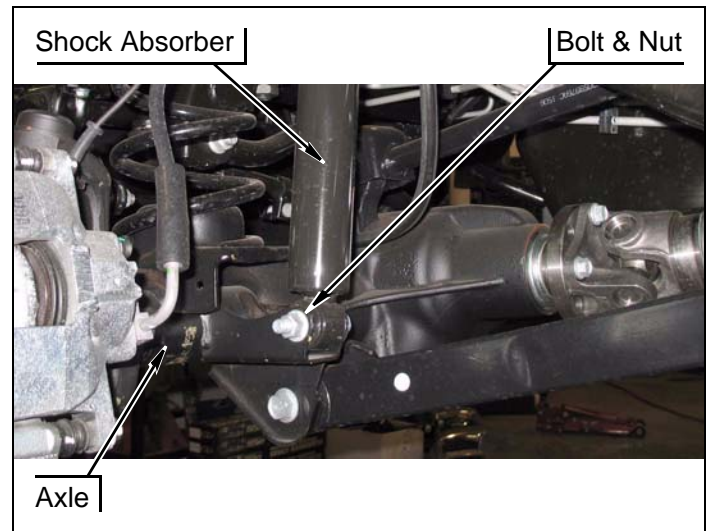

5. Remove track bar.
  - a. Remove bolt, nut with captive brace and track bar from left frame.

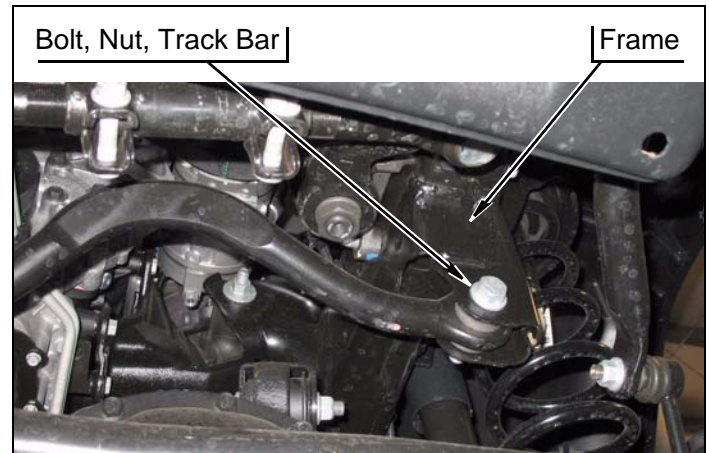

6. Remove two nuts, washers and bolts from lower sway bar links and axle.

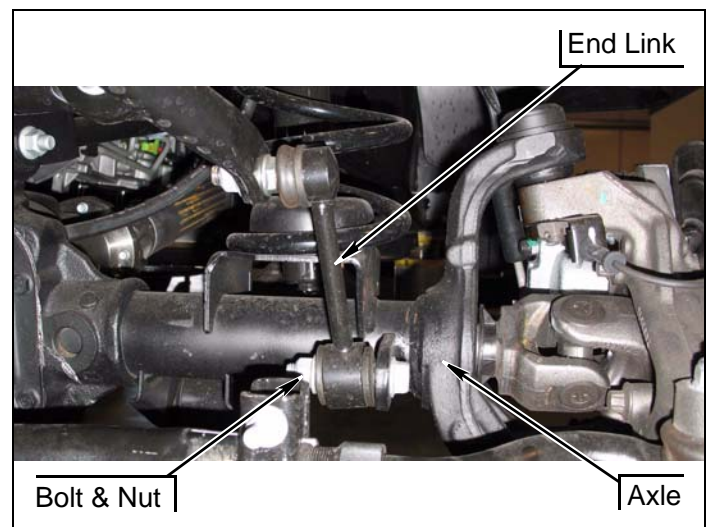

- Using hydraulic floor jack, lower front axle and remove two front coil springs.

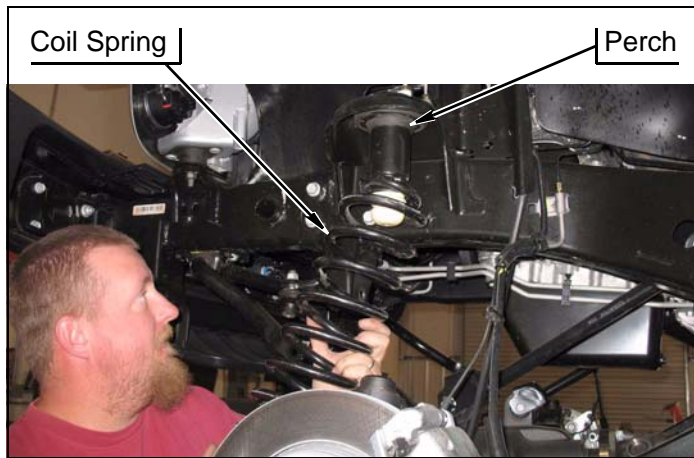

**⚠ WARNING**  
Compressed coil springs can expand violently causing serious personal injury. Before removing the coil springs, lower the axle housing as far as possible to allow the coil springs to expand.

## Install Front Suspension

- Install two *kit spring* (spacers) onto upper perch.

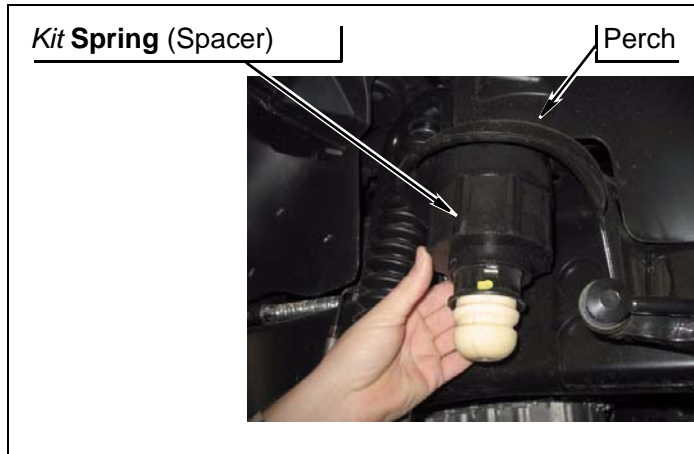

- Install factory spring onto *kit spring* (spacers). DO NOT INSTALL bottom of *kit springs* onto axle.

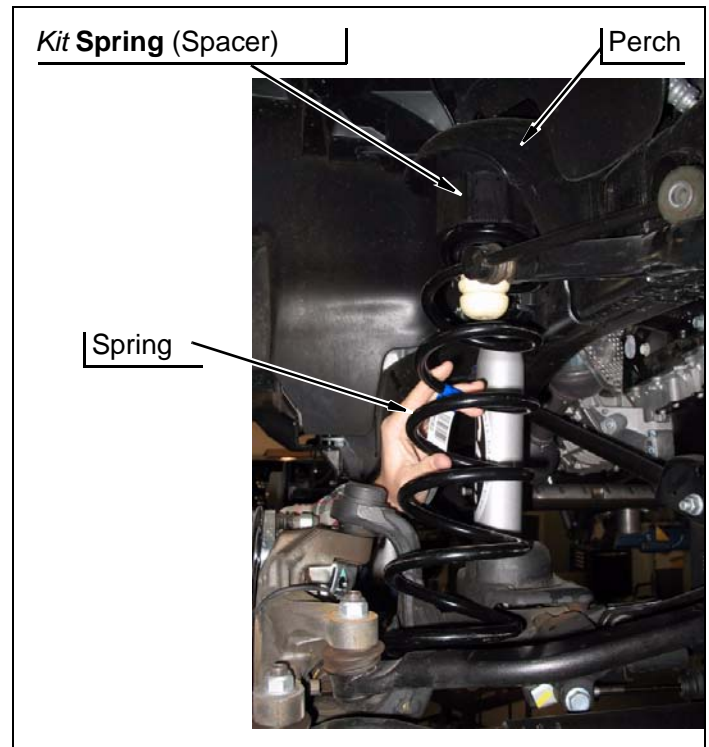

- Using hydraulic floor jack, raise axle and install two *kit absorbers* (shock, front) onto axle with two O.E. bolts and nuts.

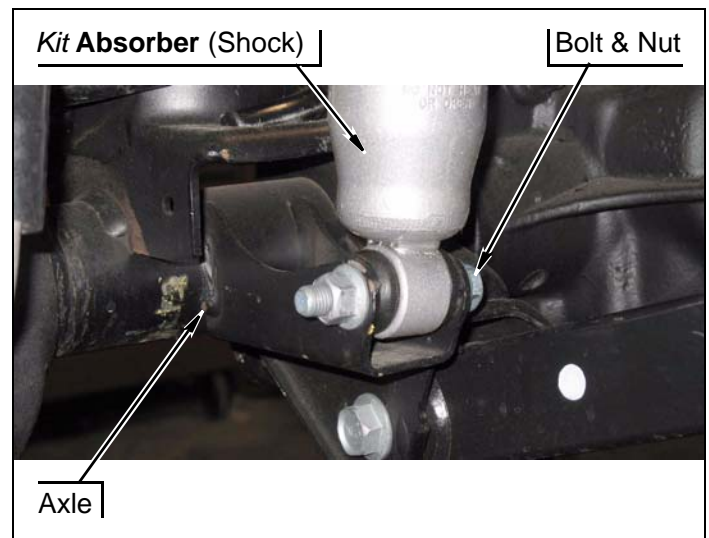

- Install lower swaybar link mount back into bracket on axle.
- Reinstall wheels and tires and lower vehicle to ground.
- Reinstall trackbar while on the ground. Have a helper slowly turn steering wheel slightly until bolt holes line up as needed.



## Engine Compartment

1. Connect both battery cables. Connect positive cable first, then negative cable.

## Miscellaneous

1. Apply **kit label** (warning) onto dashboard in plain sight of all vehicle occupants.
2. Adjust headlights.
3. Check all fasteners to ensure they are tight.
4. Ensure all wires, hoses, cables, etc. are properly connected and there is ample slack.
5. Align vehicle to OE specifications. Retain alignment results.

## Dynamic Vehicle Check

1. Check steering and suspension in all positions to ensure that there is no bind and adequate clearance between all moving, fixed, and heated members. Check operation of clutch, brake system, and parking brake. Check operation of transmission and transfer case. Ensure there is full engagement in all gears and 4WD ranges. Check battery connections and electrical component operations. Test-drive vehicle..

### **⚠ WARNING**

Retorque all fasteners after 500 miles and after off road use. All suspension lift components should be visually inspected and fasteners retorqued during routine vehicle servicing.

### **⚠ CAUTION**

Performance Automotive Group does not recommend any particular wheel and tire combinations for use with its suspension lifts and cannot assume responsibility for the customer's choice of wheels and tires. Refer to your owner's manual for recommended tire sizes and warnings related to the use of oversized tires. Larger wheel and tire combinations increase stress and wear on steering and suspension components, which leads to increased maintenance and higher risk for component failure. Larger wheel and tire combinations also alter speedometer calibration, braking effectiveness, center of gravity, and handling characteristics. Consult an experienced local off road shop to find what wheel and tire combinations work best with your vehicle.

### **NOTE**

All warranty information, instruction sheets, and other documents regarding the installation of this product must be retained by the vehicle owner. Information contained in the instructions and on the warranty card will be required for any warranty claims. The vehicle owner needs to understand the modifications made to the vehicle and how they affect vehicle handling and performance. Failure to provide the customer with this information can result in damage to the vehicle and severe personal injury.

## Kit Parts List

### **Qty. Description**

2 **Spacers**