

Rugged Ridge Front Fender Chop Bracket, JL & JT Rubicon

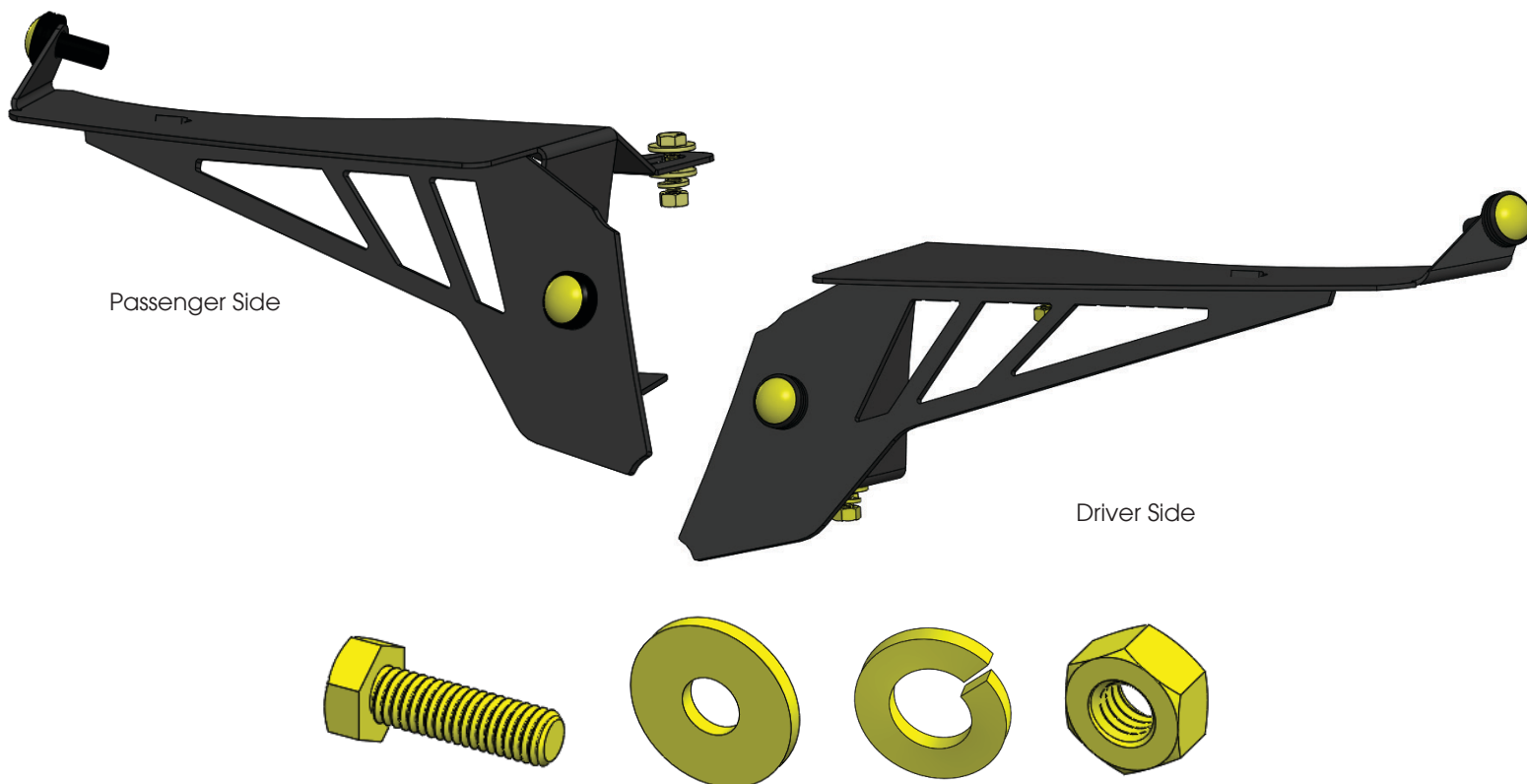

Components

1. Chop Bracket, Driver and Passenger Side	2	4. Flat Washer M6	8
2. LED pin spot amber lights	4	5. Lock Washer M6	4
3. Hex Bolt M6 x 1.0, Gold Zinc	4	6. Hex Nut M6 x 1.0, Gold Zinc	4

OMIX-ADA® TECHNICAL SUPPORT

PHONE: M-F 8am - 5pm EST 1-800-449-6649

FOR WARRANTY OR TECH CONCERNS EMAIL: webmaster@omixsupport.com

ATTN: STATE OF CALIFORNIA CONSUMERS

⚠ WARNING: Cancer and Reproductive Harm - www.P65Warnings.ca.gov.

Rugged Ridge Front Fender Chop Bracket, JL & JT Rubicon

NOTE: Following steps are shown on a Sahara model, the procedure is the same, the height of the fender varies and you'll see the Rubicon bracket accommodates for that difference.

1. Start by removing inner fender liner. This will require popping all the plastic rivets that join the liner to the fender edge. There is multiple 10mm bolts and plastic clips that must be remove to pull the liner out.



2. Remove the lower fender brace located at the rear bottom of the fender.



3. Unplug the fender wiring from the chassis harness



Rugged Ridge Front Fender Chop Bracket, JL & JT Rubicon

4. Now at the front of the fender remove additional attaching hardware. Start with the two 10mm bolts and then T25 torx screws



5. Pull splash shield down to reveal additional T25 torx screws to remove.

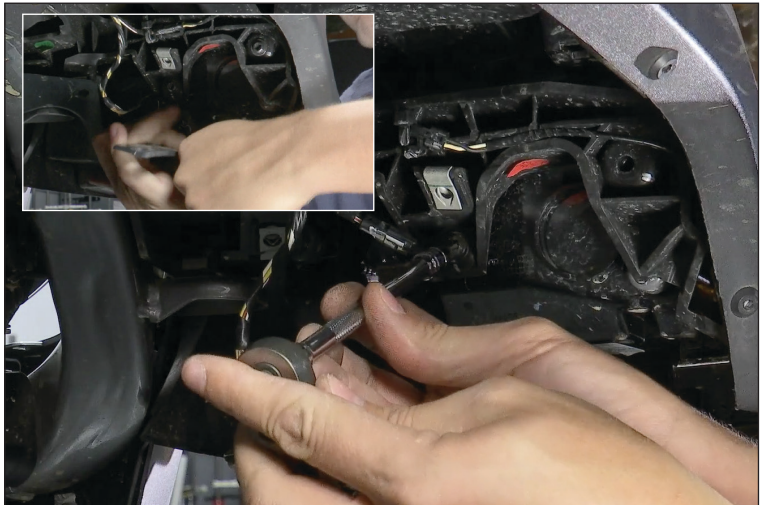

6. Disconnect side marker lights and front running lights. There are some zip ties that will need to be snipped to release the harness from the fender.

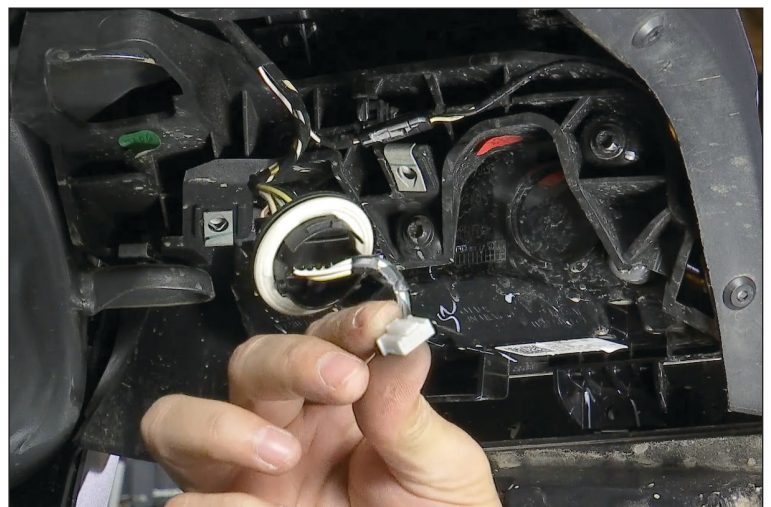

Rugged Ridge Front Fender Chop Bracket, JL & JT Rubicon

7. Firmly grab the light housing to pull the adhesive tape away to remove light from the fender.

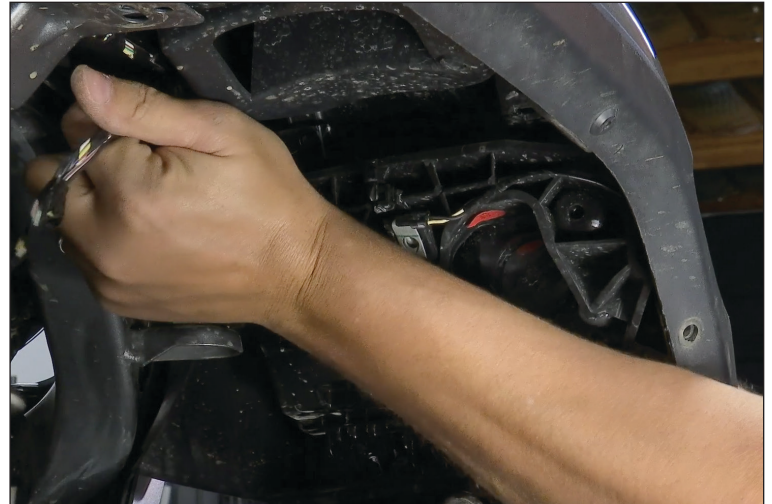

8. Now release all the white retaining clips that attach the fender to the Jeep. Use a small set of needlenose pliers to pinch the back side of the clip and pull the fender from the Jeep. The last clip at the bottom of the fender is deep in the fender. Standard needlenose pliers won't reach it. You could use a long screwdriver or just pull to release this clip. Now fender can be removed.



9. Place the fender on a soft surface to assure the paint won't be scratch during modification. First pry and remove all the fender clips to reuse later. Also remove wiring harness from fender.



Rugged Ridge Front Fender Chop Bracket, JL & JT Rubicon

10. Remove final white clip from the front of the fender. Check and assure there are no other hardware or clips holding the two pieces of the fender together.



11. Remember to place fender on a soft surface. Now pull the inner fender away from the out fender. These items are glued or fused to each other. Start at the bottom corner of the fender and pry the pieces apart from each other.



12. The locating tabs need to be trimmed away. A shape box blade works well cutting through the plastic. Feel free to use other tools if you feel fit. Take your time don't rush or force your cut. That could accidentally cause you to cut to far or scratch the paint.



Rugged Ridge Front Fender Chop Bracket, JL & JT Rubicon

13. Reinstall all the fender clips to the fender. Then attach the fender back to the Jeep.



14. Next you need to mark and drill the hole for the side marker light. First apply painters tape to the fender to assist in keeping the paint from being scratched. Now loosely install the Chop Bracket with the 2 fender mounting bolts. Mark the inside of the fender in the center of the hole of the fender bracket. Remove the bracket and drill a pilot hole to the mark you made.



15. We choose to use a step bit to fit the desirable size. You can use standard bits if you prefer. Drill and build up to the size hole needed for the LED light. Test fit the light to assure it fit's snug.

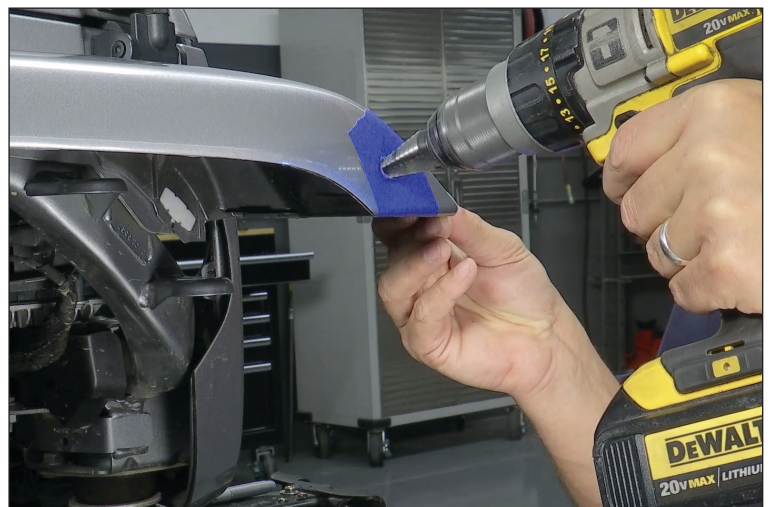

Rugged Ridge Front Fender Chop Bracket, JL & JT Rubicon

16. Before install Chop Bracket to the Jeep pre install the LED light to the front on the bracket. Now place bracket input place on the fender tabs. Push side marker LED light through the fender and Chop Bracket. Now thread and tighten the nut on the LED light.



17. Use the provided M6 bolts and washers and attach the bracket to the fender tabs. Adjust and fully tighten.



18. Now to wire the LED lights to the OE harness. Peel back a short section of the electrical tape from the turn signal light harness. You'll also will need to snip away any clips from the OE harness.

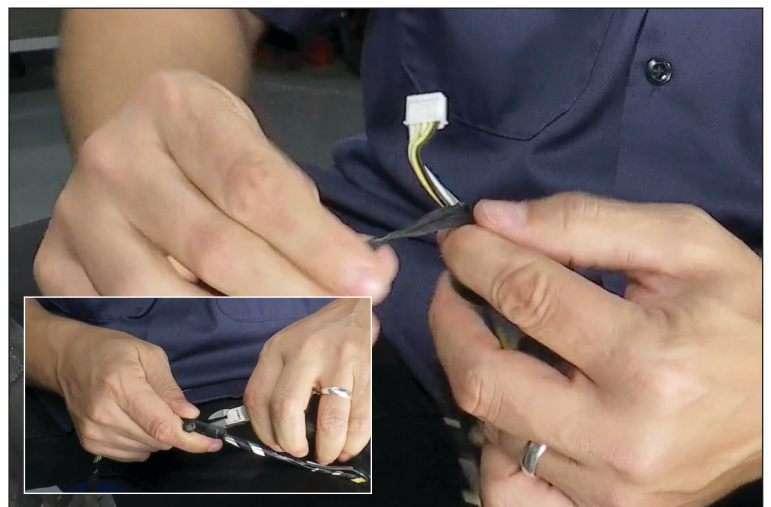

Rugged Ridge Front Fender Chop Bracket, JL & JT Rubicon

19. Concerning the method of wiring use your preferred method. We selected T-taps, it allows you to tap into the wire without cutting into the OE harness. We would also recommend soldering and using heat shrink as the best method of connection and keeping the connections waterproof.

The provided LED lights need to have the ground wires tied together to the Black wire in the OE harness. The Outer Turn Signal at the edge of the fender needs to tie into the White with Green Stripe wire. The front Running Light needs to tie to the White with Brown Stripe wire.

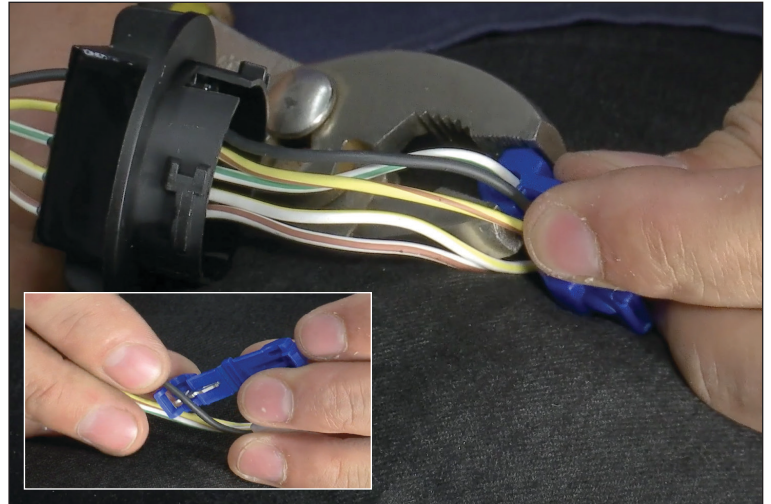

20. Now plug in the OE light harness and test the lights to assure the connections are correct and tight. If everything tests fine then route the harness away and zip tie it to keep it from getting caught or pinched.

At this point install your selected inner fenders to complete a safe and clean install.

