

XRS ROTA JEEP MOUNTING INSTRUCTIONS

Part No. 210221

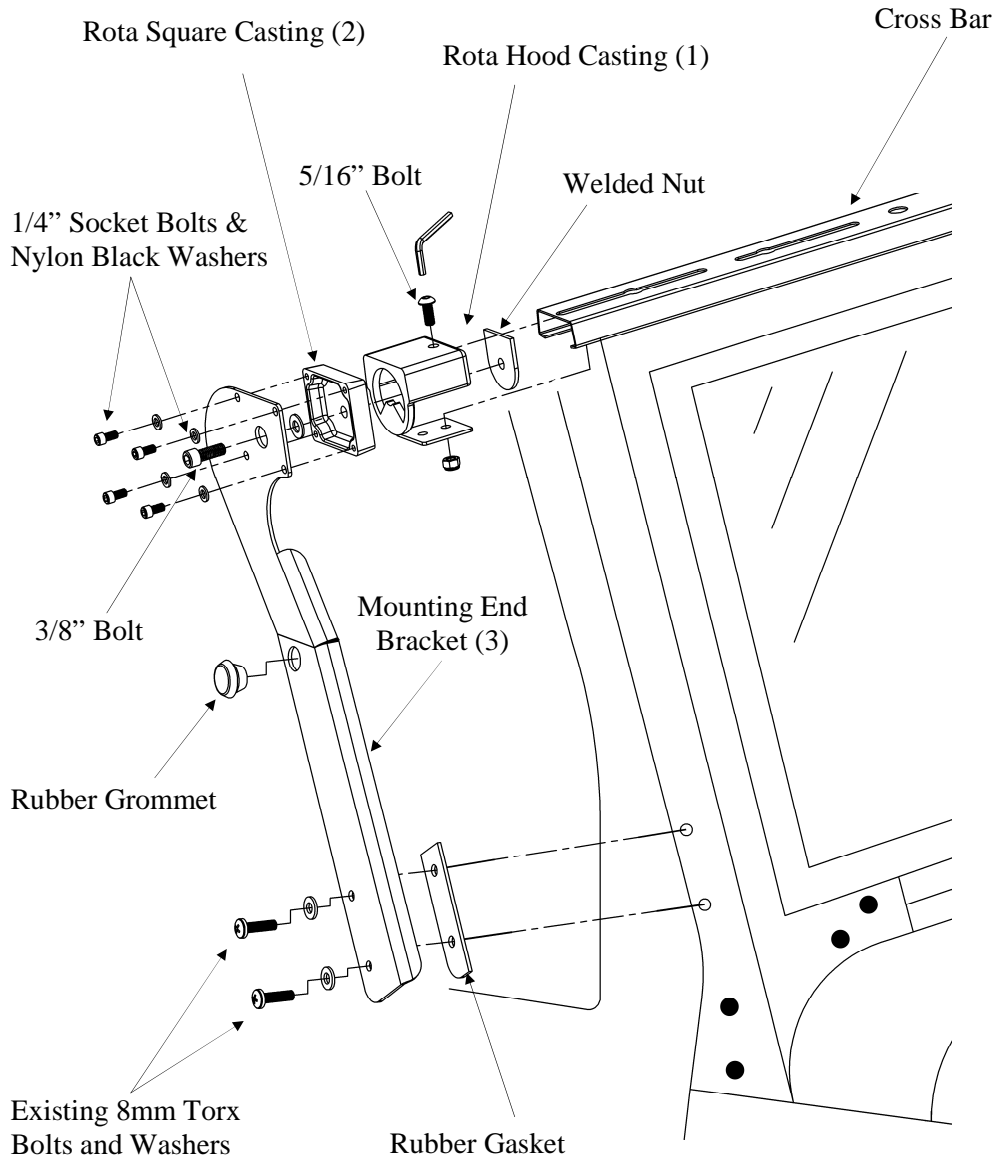

Detail A

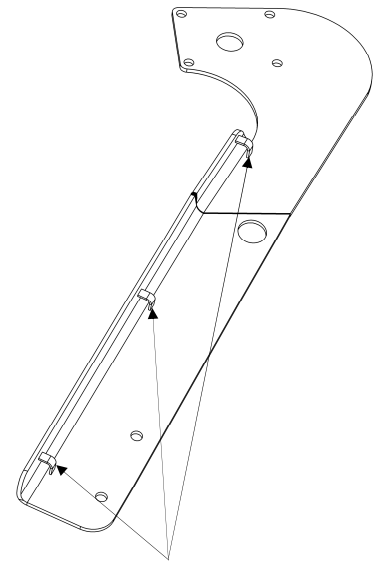

Feed the wires from your lights through these three loops on back of the Mounting End Brackets.

MATERIALS NEEDED: Wrench for 8mm Torx Bolts or an 3/16" Allen wrench, Loctite

MATERIALS FURNISHED: Two Mounting End Brackets (3), two Rota Square Castings (2), two Rota Hood Castings (1), one Cross Bar, and one Hardware Pack.

THIS LIGHT BAR FITS THE FOLLOWING VEHICLES:

JEEP
'07 – '09 X/Sahara/Rubicon Wrangler



Quality and Style that Endures

Follow the diagram and the written directions carefully for a proper, safe installation.

Should you encounter an unusual, unforeseen problem, contact our Technical Help Line

7:00 AM – 3:00 PM Pacific Time
(951) 719-1068

Visit our web-site at

www.CARR.com

Carr Pattern Co., Inc.

XRS ROTA JEEP MOUNTING INSTRUCTIONS

Part No. 210221

WARNINGS!

- ✓ Do not over tighten the nuts and bolts or damage to the castings and or stripping of the threads could result.
- ✓ FOR SAFE AND PROPER USAGE OF THIS PRODUCT, THE MOUNTING INSTRUCTIONS MUST BE FOLLOWED CAREFULLY AND COMPLETELY.
- ✓ The manufacturer and distributor of this product are in no way responsible for the consumer's failure to adhere to the warnings and directions of these instructions in the event of damage to the consumer's vehicle, other properties and or personal injury.

1. Read these instructions through first to save yourself time when installing this product.
2. Take the black Rubber Grommet and twist it in the hole like you are screwing a bolt into a threaded hole until the smaller end comes all the way through. A little oil on the grommet will help make this easier.
3. Assemble Rota Hood Casting 1 to Rota Square Casting 2 as shown in the diagram. The 3/8" socket bolt with the 3/8" washer goes through the Rota Square Casting 2 and Rota Hood Casting 3 into the Welded Nut. The Rota Hood Casting 3 will swivel on the Rota Square Casting 180 degrees. Leave that assembly hand tight.
4. Take four of the 1/4" socket head screws and four of the 1/4" black nylon washers and assemble the Mounting End Bracket to the assembly referred to in the above step. See diagram. NOTE: We recommend using a small amount of Loctite on the threads before screwing these socket bolts in. Securely tighten these four bolts.
5. Repeat the above steps for the other side.
6. Take the cross bar and place it up into one of the Rota Hood Casting 3. You may have to squeeze the end of the bar to get it all the way up.
7. Take a 5/16" bolt and place it through the hole on the top of the Rota Hood Casting 3, through the cross bar, through the washer with two holes into a 5/16" nylon lock nut. See the diagram for positioning of all the parts.
8. Make sure the cross bar is up against the Welded Nut.
9. Securely tighten the 5/16" hardware.
10. Repeat steps 5 - 8 for the other end of the cross bar.
11. Now your entire XRS Rota Jeep Light bar is assembled.
12. You will need two people to install this light bar to your vehicle.
13. Each person needs to grab an end of the light bar and position themselves near the bolts that will be removed for installation. See diagram for bolt locations.
14. You will install one side at a time.
15. While one person holds one end, the other will take the 8mm Torx wrench or a 3/16" Allen wrench will work and remove the two Torx bolts with their washers as indicated in the diagram from your vehicle.
16. Use a small amount of Loctite on the threads of the removed Torx bolts when reinstalling.
17. Take the appropriate Mounting End Bracket with the Rubber Gasket and put the two Torx bolts with their washers through the holes in the Mounting End Brackets, through the holes in the Rubber Gasket and screw them into the vehicle.
18. Before you completely tighten these bolts, make sure the edge of the Mounting End Bracket is not interfering with the door. The edge of the Mounting End Bracket should be parallel to the door opening.
19. Now securely tighten the two Torx bolts.
20. Now install the other side by repeating steps 14 – 18.
21. Take your 5/16 Allen wrench, provided for you, and securely tighten the 3/8" bolt to insure your bar does not rotate.
22. You can install our lights at this point or you can install them prior to mounting the light bar to your vehicle.
23. Refer to Detail A when installing your lights and routing your wires.
24. CAUTION: WHEN LIGHTS ARE INSTALLED ON YOUR BAR AND YOU WANT TO LOOSEN THE BAR TO ROTATE THE BAR DOWN, BE CAREFUL NOT TO LOOSEN TOO MUCH BECAUSE LIGHTS COULD CRASH AGAINST THE VEHICLE AND CAUSE DAMAGE TO THE VEHICLE AND THE LIGHTS. ALSO, DO NOT LOSE YOUR 5/16" ALLEN WRENCH.
25. Check again and securely tighten ALL hardware.
26. Now your light bar is ready for use.
27. After one month of use, go back and make sure that all the hardware is still tight.

Carr Pattern Co., Inc. Warranty Policy

Finishes: Limited Lifetime

Structural Warranty: Limited Lifetime

Warranty Conditions:

- a. All warranties start from consumer's date of purchase.
- b. A new product will be sent out immediately to replace a warranty claim.
- c. The above guidelines apply only to the Original Purchaser.
- d. Original proof of purchase must be submitted for all warranty and returns issues.

Warranty Limitations:

- a. Warranty coverage extends ONLY to repair or replacement of the CARR product. This warranty does not cover the cost of labor, transportation, installation or removal of the product.
- b. Warranty coverage does not extend to damage caused by: collision, fire, theft, freezing, vandalism, riot, explosion or object striking the product, or misuse of the product and/or the vehicle on which the product is being installed.
- c. Warranty coverage does not extend to damage caused by: airborne fallout (chemicals, tree sap, etc.), stones, hail, earthquake, water or flood, windstorm, lightning, the application of chemicals or sealants subsequent to manufacture.
- d. Warranty coverage does not extend to damages caused by: normal wear and tear, abuse, modification or improper installation of the product.
- e. Warranty coverage does not extend to any economic loss or extra expense including (without limitation), payment for the loss of time or pay, inconvenience, storage, loss of vehicle use, vehicle rental expense, equipment rental expense, lodging, meals, or other travel costs.

Other Terms:

This warranty gives you specific legal rights and you may also have other rights that vary from state to state. CARR does not authorize any person to create for it any other obligation or liability in connection with its products. ANY IMPLIED WARRANTY OF MERCHANTABILITY OR FITNESS FOR A PARTICULAR PURPOSE APPLICABLE TO THIS PRODUCT IS LIMITED IN DURATION TO THE DURATION OF THIS WRITTEN WARRANTY. PERFORMANCE OF REPAIRS AND NEEDED ADJUSTMENTS IS THE EXCLUSIVE REMEDY UNDER THIS WRITTEN WARRANTY OR ANY IMPLIED WARRANTY. CARR SHALL NOT BE LIABLE FOR INCIDENTAL OR CONSEQUENTIAL DAMAGES RESULTING FROM BREACH OF THIS WRITTEN WARRANTY.*

*Some states do not allow limitations on how long an implied warranty will last or the exclusion or limitation of incidental or consequential damages, so that above limitations or exclusions may not apply to you.

Guarantee: Every attempt has been made to manufacture and distribute the finest quality products available. Our manufactured products are guaranteed to be free of defects due to workmanship or materials. Distributed products are subject to manufacturer's warranty only.