





# Installation Instructions Header Bikini®

## Vehicle Application

- Jeep Wrangler JK (2 Door)  
2010 and newer  
Part Number: 52586

[www.Bestop.com](http://www.Bestop.com) - We're here to help! Visit our web site and click on ["Ask a Question"](#). Click here for more [Jeep Accessories by Bestop](#).

INSTALLATION TIME	SKILL LEVEL
 1/2 Hour	 1 - Easy

TOOLS
 Safety Glasses



This product must be used with a Windshield Header Kit Part Number 51243.

### Installation Tips

Before you begin installing this assembly, read all instructions thoroughly.

#### For a smooth fit:

For ease in installation, the product should be installed at temperatures above 72° F. Below this temperature, the fabric may contract an inch or more, making it difficult to fit to the vehicle. It is normal for fabric to contract and wrinkle when stored in the shipping carton. Within a few days after the installation, the fabric will relax and the wrinkles will disappear.

 **CAUTION** Safety glasses should be worn at all times while installing this product.

 **WARNING** This product is designed primarily to enhance the appearance of the vehicle and to shield the occupants from ordinary weather conditions. Do not rely in any way on the components of this product to contain occupants within the vehicle, or to protect against injury or death in the event of an accident. This product will not protect the occupants from falling objects. Never operate the vehicle in excess of manufacturer's specifications.

### WEAR SEAT BELTS AT ALL TIMES

Read and follow, precisely, all installation instructions provided when installing product. Failure to do so may result in a poor fit and could place occupants of the vehicle in a potentially dangerous situation.

# Header Bikini® – Installation Instructions

## Parts List

Bikini	Qty - 1
Long Tension Strap, Part Number 424.14	Qty - 2
Short Tension Strap, Part Number 460.37	Qty - 2

### 1 Snap Bikini to Header

Slide the pocket sewn along the front of the Bikini over the edge of the header and snap it to the snaps.

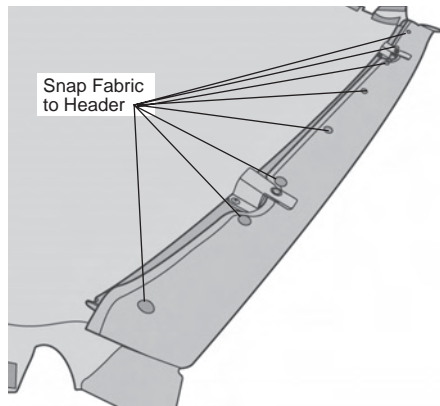

### 2 Secure Header to Windshield

Center the Bikini on the vehicle. Place the tabs on the Header Knob Bases above the footman loops in the windshield frame. Place a Header Knob Plate under a footman loop. Install a Header Knob through the plate and footman loop and thread it into the Header Knob Base. Repeat this with both Header Knob Bases.

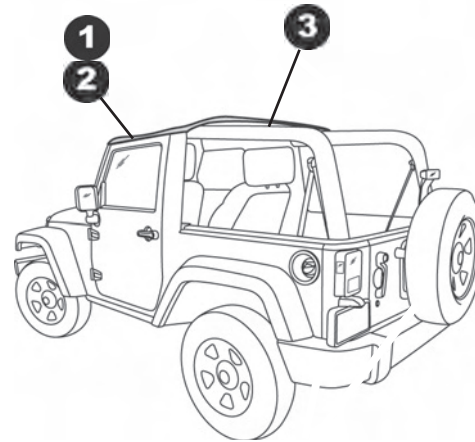
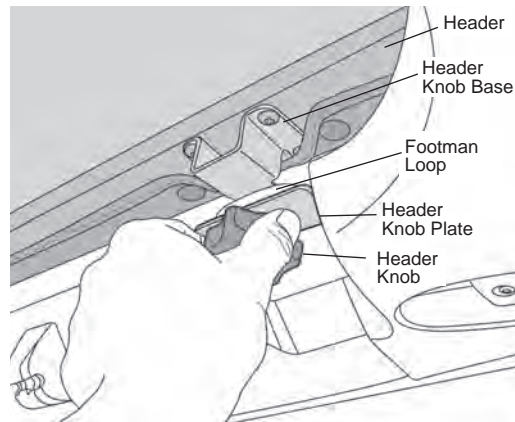

### 3 Install Short Tension Straps

Drape the Bikini over the speaker pod. Thread a Short Tension Strap through the two buckles sewn to the rear of the bikini. Pull the straps under the pod and hook each strap into the opening as shown. Pull the end of each strap to tighten securely.

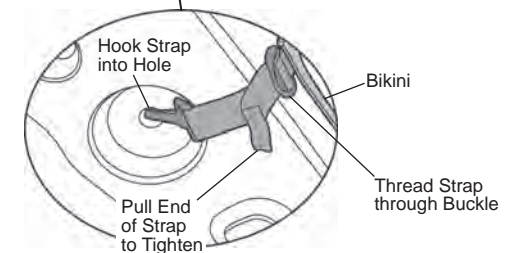
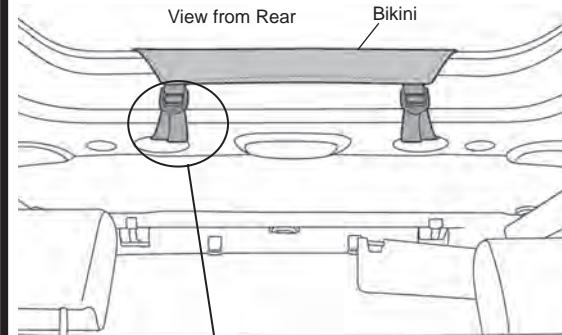

# Header Bikini® – Installation Instructions

## 4 Secure Flaps

Wrap the flap above the door opening around the horizontal sport bar and fasten the hook and loop. Repeat on both sides.

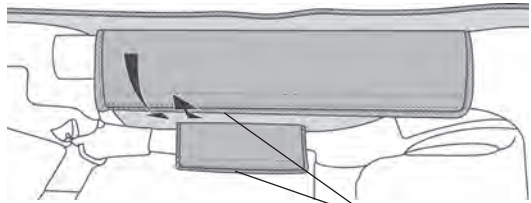

Wrap Flaps around bars and fasten Hook and Loop

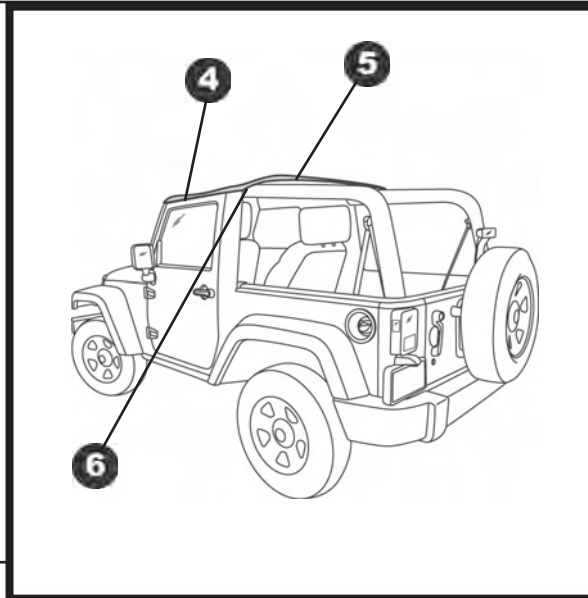

## 6 Secure Rear Corner Straps

Locate the buckle straps sewn to the rear corners of the Bikini . Wrap the strap under the Bikini and around the sport bars. Thread the end of the strap through the buckle and pull it tight. Repeat on the other side.

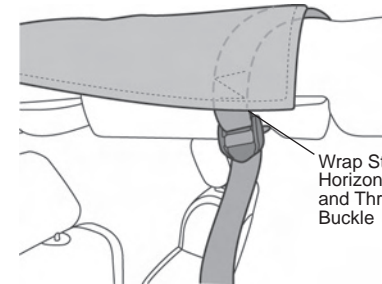

Wrap Strap around Horizontal Sport Bar and Thread Through Buckle

## 5 Install Long Tension Straps

Thread a Long Tension Strap through the buckle on the side of the Bikini. Pull the strap under the pod and hook it into the same hole as the right rear buckle strap. Repeat on the other side of the vehicle.

Thread Strap through Buckle

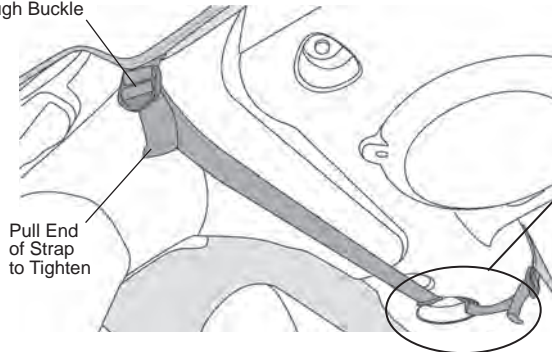

Pull End of Strap to Tighten

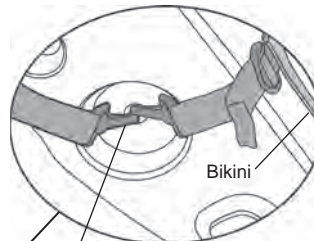

Hook Strap into Hole

## Header Bikini® – Installation Instructions

---

### Care and Maintenance of your Bestop Product

Your Bestop product is made of the finest materials available. To keep it looking new and for the maximum possible wear, it will need periodic cleaning and maintenance.

**Washing:** The fabric should be washed often using soap, warm water and a soft bristle brush. Rinse with clear water to remove all traces of soap or use Bestop-recommended Bestop Cleaner and Bestop Protectant. Bestop Cleaner and Bestop Protectant are specially formulated to provide a total cleaning and protection system. Bestop Cleaner will not harm vehicle finish, is biodegradable and environmentally friendly. Bestop Protectant protects against UV-fading, cracking and hardening.

**Water:** Seeping through at the seams may be stopped by applying 3-M Scotchgard® on the inside of the seams. Rips in the fabric may be repaired with Bondex® iron on patches. Iron the patches to the Inside of the top, carefully following the Bondex® instructions.

---

### LIMITED WARRANTY

We warrant our product to be free from defects in material and workmanship, for the terms specified below, provided there has been normal use and proper maintenance. This warranty applies to the original purchaser only. All remedies under this warranty are limited to the repair or replacement of any item or items found by the factory to be defective within the time period specified. If you have a warranty claim, first you must call our factory at the number below for instructions. You must retain proof of purchase and submit a copy with any items returned for warranty work. Upon completion of warranty work, if any, we will return the repaired or replaced item or items to you freight prepaid. Damage to our products caused by accidents, fire, vandalism, negligence, misinstallation, misuse, Acts of God, or by defective parts not manufactured by us, is not covered under this warranty.

THE WARRANTY TIME PERIOD IS AS FOLLOWS FOR REPLACE-A-TOP™, SAILCLOTH REPLACE-A-TOP™, SUPERTOP®, SUPERTOP® REPLACEMENT SKINS, SUNRIDER®, AND TIGERTOP®: TWO YEARS FROM DATE OF PURCHASE.

THE WARRANTY TIME PERIOD IS AS FOLLOWS FOR ALL OTHER “SOFT GOODS” MANUFACTURED BY OUR COMPANY (USING PRIMARILY VINYL, PLASTICS, AND/OR FOAM): ONE YEAR FROM DATE OF PURCHASE.

THE WARRANTY TIME PERIOD IS AS FOLLOWS FOR ALL OTHER “HARD GOODS” MANUFACTURED BY OUR COMPANY (USING PRIMARILY METALS, PLASTICS, AND/OR FIBERGLASS): ONE YEAR FROM DATE OF PURCHASE.

ANY IMPLIED WARRANTIES OF MERCHANTABILITY AND/OR FITNESS FOR A PARTICULAR PURPOSE CREATED HEREBY ARE LIMITED IN DURATION TO THE SAME DURATION AND SCOPE AS THE EXPRESS WRITTEN WARRANTY. OUR COMPANY SHALL NOT BE LIABLE FOR ANY INCIDENTAL OR CONSEQUENTIAL DAMAGE.

Some states do not allow limitations on how long an implied warranty lasts, or the exclusion or limitation of incidental or consequential damages, so the above limitations or exclusions may not apply to you. This warranty gives you specific legal rights, and you may also have other rights which vary from state to state.



For further information or request for warranty work, please contact:  
Bestop Inc. Customer Service  
Toll-Free: (800)845-3567  
Main: (303)465-1755  
E-mail: [csbestop@Bestop.com](mailto:csbestop@Bestop.com)  
Website: [www.Bestop.com](http://www.Bestop.com)