

QuadraTop® Tonno Cargo Cover

Installation Manual for '87-'06 Jeep® YJ & TJ Wrangler Vehicles
#11051.0015, #11051.011X, #11051.02XX and #11051.03XX



⚠ WARNING ⚠

Loss of vehicle control involves risk of death or serious injury, particularly to parts of your body not restrained within vehicle. This product is intended for weather protection only and should not be relied upon to contain occupants in the event of an accident or to protect from either ground contact or falling objects. To reduce risk of accident or injury:

- **ALWAYS WEAR SEATBELTS**
- Always keep head, arms & body parts within vehicle.
- Fully secure or stow the fabric top before driving according to instructions. Never try to adjust the fabric top while driving. Do not use if damaged or worn.
- Read and follow all instructions & warnings accompanying this product, in your vehicle owner's manual and Off Road Driving Supplement.

⚠ CAUTION ⚠

RISK OF EYE INJURY. Safety glasses should be worn at all times while installing or maintaining this product.

PARTS LIST:

FABRIC CARGO/TONNO COVER - QTY 1

REQUIRED TOOLS:

SAFETY GLASSES

FOR 03-06 WRANGLER VERSION:

WEB BUCKLE STRAP - QTY 1



The Trusted Source

Important Safety Information:

Your QuadraTop® Tonno Cover is intended to increase the fair weather enjoyment of your off-road capable vehicle. Before installation, please take a moment to review the following safety

information and installation instructions. Important safety information is generally preceded by one of three signal words indicating the relative risk of injury. The signal words mean:

⚠ WARNING ⚠

a hazardous situation which, if not avoided, could result in death or serious injury. You CAN be KILLED or SERIOUSLY HURT if you don't follow instructions.

⚠ CAUTION ⚠

a hazardous situation which, if not avoided, could result in minor or moderate injury. You CAN be moderately HURT and also may suffer property damage if you don't follow instructions.

NOTICE

Careful attention is required to this instruction or operation but does generally not relate to personal injury. Damage to your Quadratec® product or other property may result if you don't follow instructions.

Before You Begin Installation:

Congratulations on your purchase of the QuadraTop Tonno Cover! This high quality tonno cover is designed to enhance looks and provide cargo protection and enhance fair weather driving pleasure. We have used only the finest materials in creating this cargo cover but like any product that is exposed to the elements, there is some general maintenance that is required to keep it looking like new. Please see page 9 for these important maintenance tips.

When unpacking, check to make sure all parts are included. If any part is missing or broken, please call Quadratec Customer Service at 800-745-6037 as soon as possible.

Important: Make sure you become familiar with the installation process of this product by reading the following instruction sheet thoroughly. As you will see, these instructions are broken-out depending on the door configuration of your '87-'06 YJ or TJ Wrangler vehicle.



Important: For a smooth fit and ease of installation, this product should be installed at temperatures above 72 degrees. Below this temperature, the fabric may contract an inch or more making it difficult to install.

We highly recommend taking the product out of the package and letting it sit inside a warm place or direct sun light for 1-2 hours before you install the top. When warm, this product will install quickly. It is normal for the fabric to contract and wrinkle when stored in the shipping carton. In a few days the fabric will relax and wrinkles will disappear.

Thank you again for your purchase and let's start the installation process!



The Trusted Source

Tonno Cover Installation:

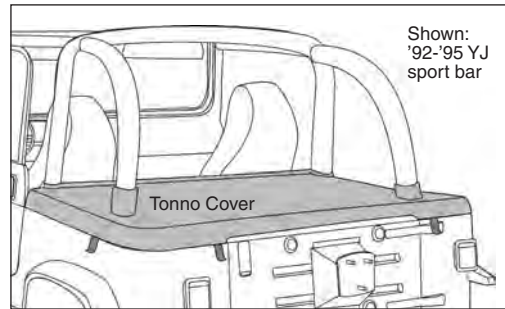
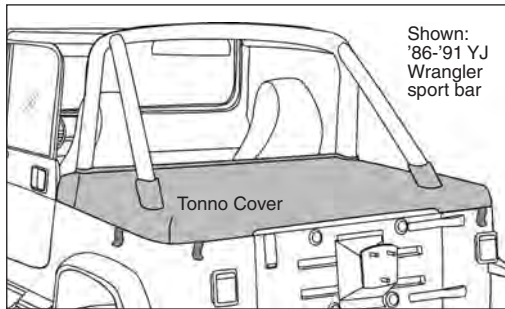

Tonno Cover Concept:

The QuadraTop Tonno cargo cover is a handsome, aerodynamic way to cover your Wrangler rear-seat/cargo area at times when you drive in fair weather without your normal soft top put away. These Tonno covers are designed to be installed on vehicles with a factory soft top only. If you do not have a factory style soft top, this product will not fit.



The Tonno is also ideally designed to be used in combination with our Bimini brief cab top and our Clearview Windstopper curtain to complete the ultimate "summer combo".

If you still need to purchase a Bimini Top, or the Clearview Windstopper, go online @quadratec.com to find the correct application for your particular Jeep Wrangler vehicle.

NOTICE

This product is designed for fair weather protection only and is not completely waterproof. Water may enter the inside of the vehicle during inclement weather or if pooling of water occurs. If pooling occurs, remove the water before driving to avoid water flowing forward into the cab of your Jeep.

Installation Notes: Tonno Cargo Cover

Please note that in the case of '87-'91 and '92-'95 Wrangler vehicles, the drawings in this booklet are for '92-'95 YJ with the later style sport bar design. Product installation is the same for both YJ Wrangler models regardless of sport bar configuration. These two sport bar styles are shown at top of this page.

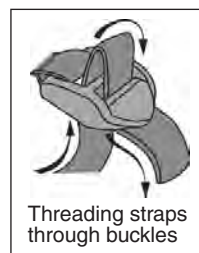

Threading Straps Through Buckles:
During installation you will need to thread web straps through buckles. Review diagram for correct strap routing.



The Trusted Source

Step One: for '87-'95 YJ Wrangler only

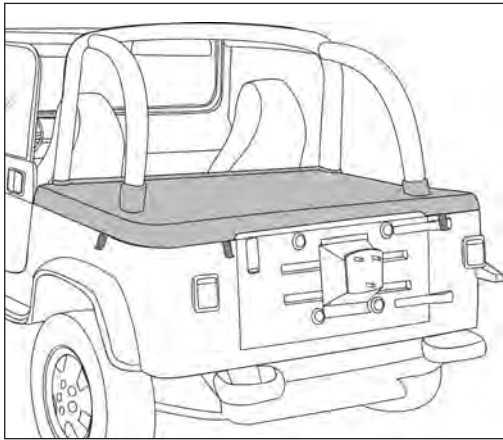

REMOVE SOFT TOP MATERIAL FROM TOP HARDWARE

Put on safety glasses. Remove your soft top from the hardware. Gently fold your soft top and store in a safe dry place. If possible, place dry towels between the windows to prevent scratching. Fold the factory soft top hardware down onto vehicle body. Make sure the hardware system lies as flat as possible with the bow assembly resting against the rear sport bar on '92-'95 models and against the rear tailgate retainer on '87-'91 model vehicles.

Step Two: for '87-'95 YJ Wrangler only

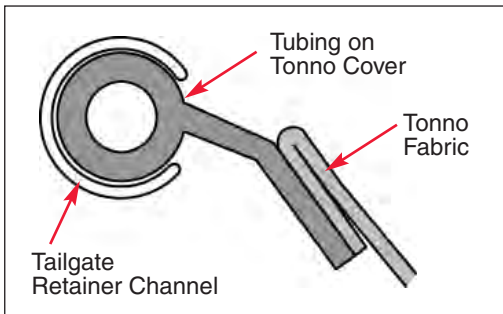

FOLD REAR SEAT AND INSTALL TAILGATE RETAINER CHANNEL
Fold down or remove the rear seat. Take the Tonno Cover and position it on the vehicle with the rear edge facing you.

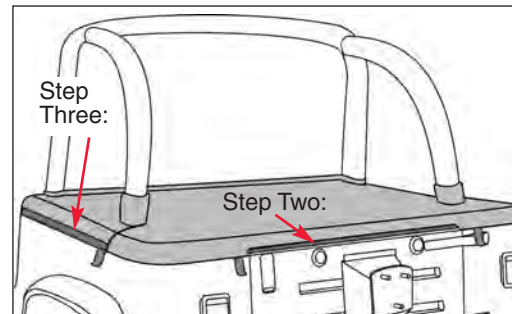

From the back of the vehicle, hold the Tonno cover with the backing (under) side toward you. Slide the tubing on the Tonno into the channel in the tailgate retainer. See above left.

Step Three: for '87-'95 YJ Wrangler only

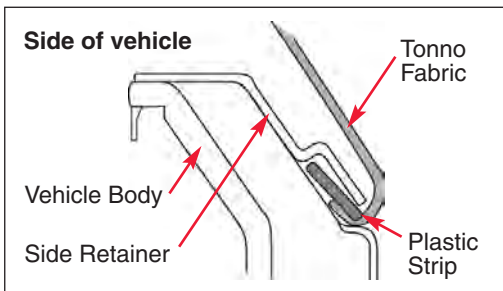

SLIDE PLASTIC STRIPS ON TONNO INTO SIDE RETAINERS ON VEHICLE
Drape the fabric forward over the rear of the vehicle. Using the web straps sewn to the cover, slide the plastic strips on the sides of the Tonno into the Side Retainers on your vehicle. See the illustration at left for reference.



The Trusted Source

Step Four: for '87-'95 YJ Wrangler only

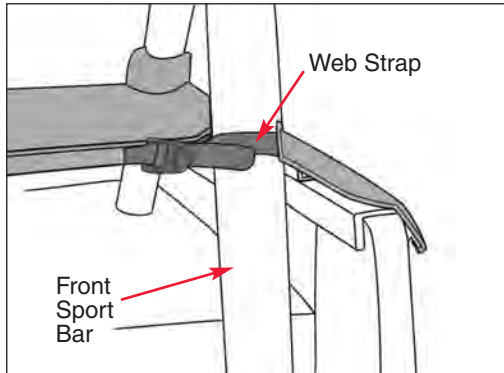

SECURE FRONT TONNO STRAPS TO FRONT OF SPORT BAR

Locate the web straps with buckles attached on the front area of the Tonno Cover. Wrap strap around the front sport bar and thread end through the buckles.

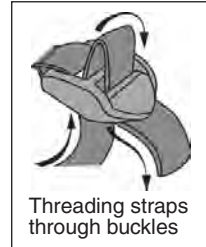

Repeat on opposite side of vehicle.

Step Five: for '87-'95 YJ Wrangler only

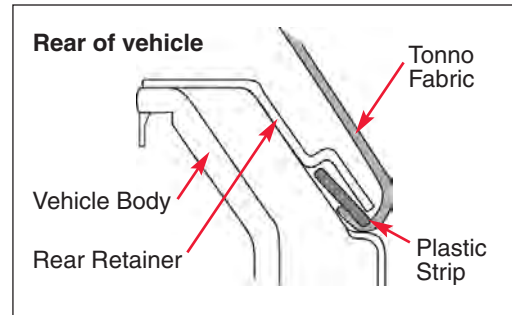
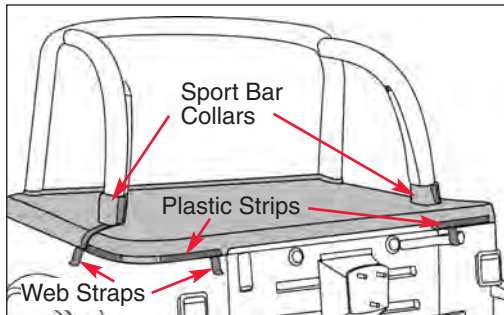

SECURE REAR CORNERS
Slide the plastic strips, sewn into the rear corners of the cover into the Corner Retainers. Use the web straps sewn to the cover to slide the corner plastic strip

toward the front of the vehicle and make sure that the plastic strip fits up into the retainer so that the rear sport bar collars fit properly.

Step Six: for '87-'95 YJ Wrangler only

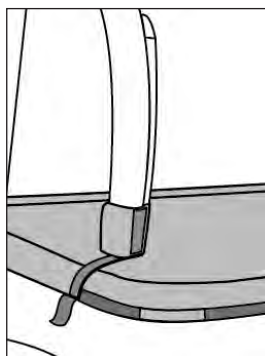

TUCK SEAT-BELTS AND CLOSE SPORT BAR COLLARS
Tuck the seat belt assemblies into the rear sport bar collars.

collars by pulling firmly on the fabric and by fastening the Hook and Loop strips to each other.

Finally, close the rear sport bar

Repeat on opposite side of vehicle.

Install complete for '87-'95 YJ QuadraTop Tonno Cover!



The Trusted Source

Step One: for all '97-'06 TJ Vehicles

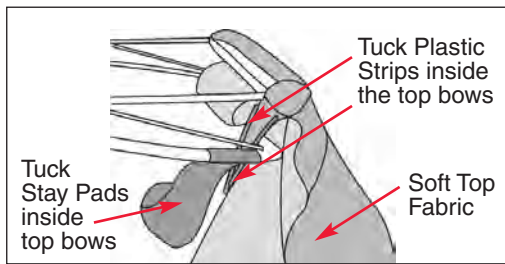

on the rear and quarter windows and store them while not in use. Release the front of the top from the windshield.

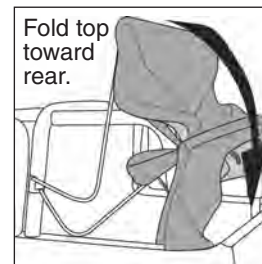

FOLD DOWN YOUR SOFT TOP
Remove the Rear Quarter Windows and Rear Window from the top. Remove Tailgate Retainer from Rear Window. Use clean towels to protect the "glass"

Raise front of the deck and collapse the rear bows, tucking the 2 plastic strips above the door openings and the "stay pad" on the rear bow inside of the bows, as seen in illustration above left.

Step Two: for all '97-'06 TJ Vehicles

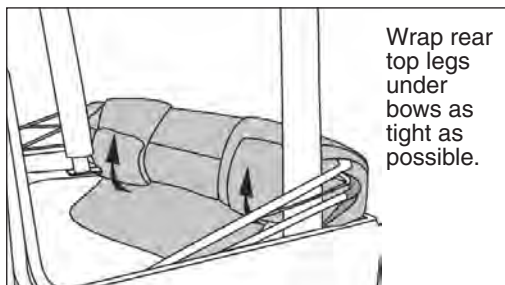
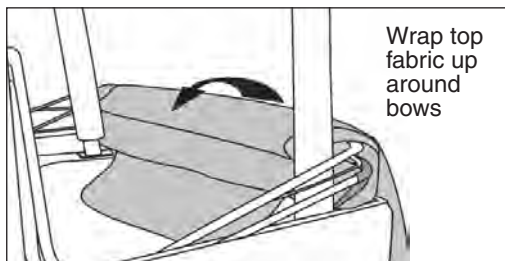

WRAP TOP FABRIC AROUND BOWS
Lay the bows down along the rear of the vehicle. Wrap the fold of fabric from the rear of the vehicle up around the bows. Then tuck the rear legs of top under the bows and wrap them around the deck fabric as tight as possible. Tuck the fabric and bows down into the tub as far as possible.

Step Two A: for '03-'06 Vehicles only

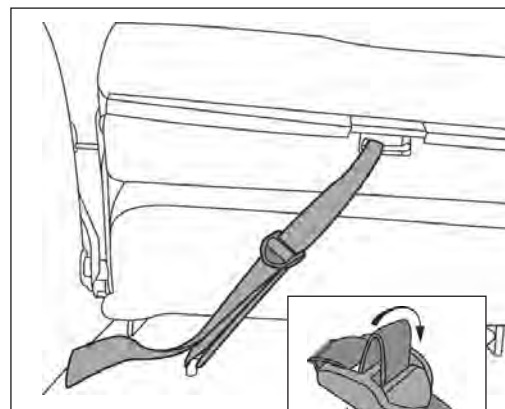

SECURE THE REAR SEAT
Locate the Web Buckle Strap in the parts kit. Thread the web end of the strap through the footman loop closest to the rear of the seat on the Driver's side. Fold the back of the seat down and thread the web through the bar on the seat back. Thread the end of the strap through the buckle and pull it tight. Tightening the strap securely will keep the rear seat from banging when the vehicle is moving.



The Trusted Source

Step Three: for all '97-'06 TJ Vehicles

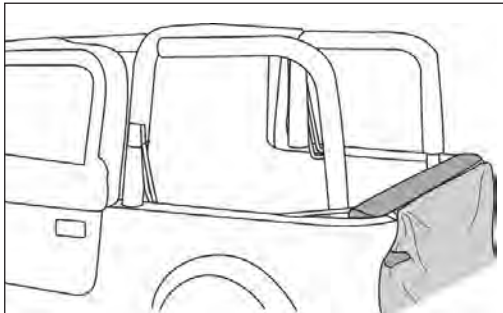

INSTALL TAILGATE BAR

From the back of the vehicle, hold the Cargo Cover with the backing side toward you. Slide the tubing on the

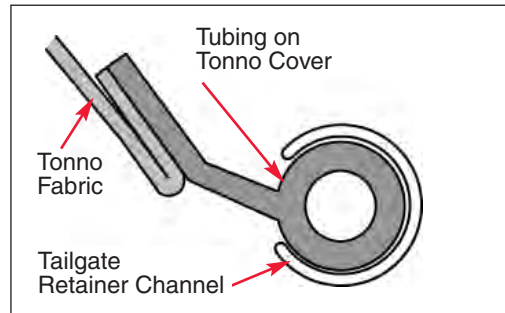

Tonno Cover into the channel in the Tailgate Retainer and install the retainer into the Tailgate Retainer Mount on your vehicle.

Step Four: for all '97-'06 TJ Vehicles

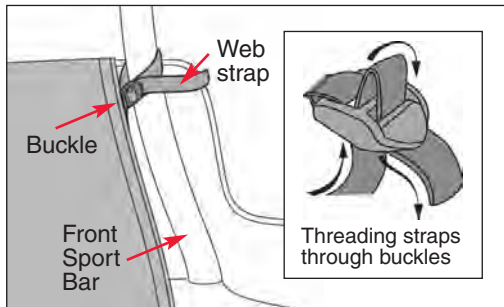

SECURE WEB STRAPS

Now drape the Tonno fabric forward over the rear of the vehicle and locate the web straps, with buckles attached, on the front of the Tonno. Wrap the straps around the front sport bars and thread the ends loosely through the buckles. Do not pull the straps tight at this time.

Step Five: for all '97-'06 TJ Vehicles

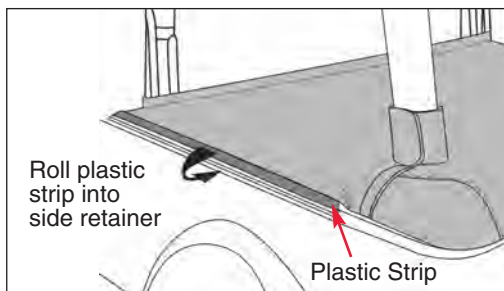

SECURE PLASTIC STRIPS ON SIDES

Locate the plastic strip sewn to the Tonno Cover along each side of the vehicle. Start at one end on each side

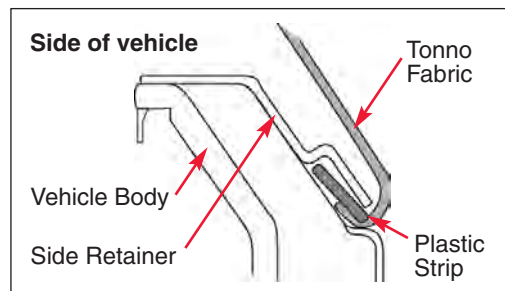

and the plastic strip into the Side Retainers. Do one side then repeat on the opposite side.



The Trusted Source

Step Six: for all '97-'06 TJ Vehicles

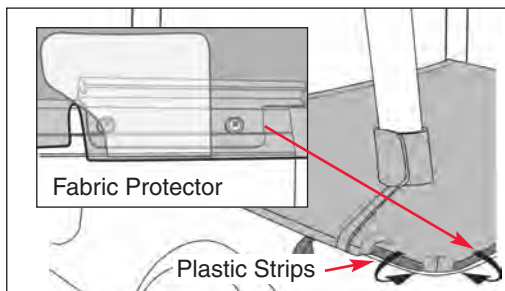

SECURE REAR CORNERS
Roll the plastic strips, sewn into the rear corners of the Tonno Cover into the Corner Retainers. Slide the corner plastic strip toward the front of the vehicle and make sure that the

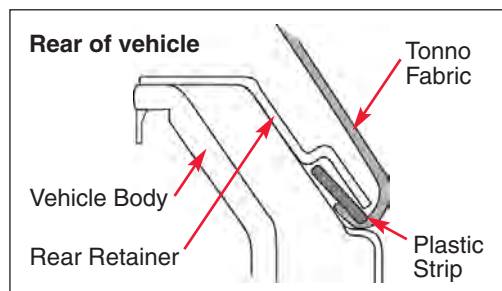

plastic strip fits up into the retainer so that the sport bar collars fit properly.

NOTE: The Fabric Protector sewn into the fabric must be located over the Tailgate Retainer Mounts.

Step Seven: for all '97-'06 TJ Vehicles

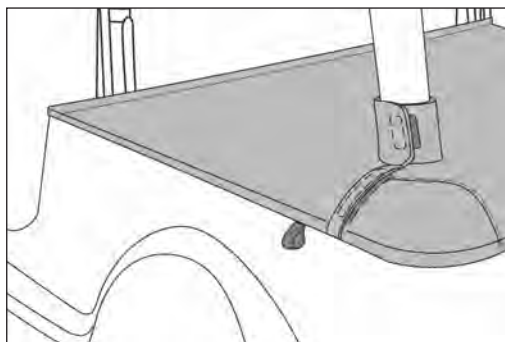

SECURE SPORT BAR COLLARS
Tuck the rear seat belt assemblies into the rear sport bar collars and close the rear sport bar collars by pulling firmly on the fabric and fastening the Hook and Loop Strips to each other. Then, finally tighten the web straps on the front of the Tonno Cover.

Install now complete for '97-'06 TJ QuadraTop Tonno Cover!

Optional Steps: for all '97-'06 TJ Vehicles

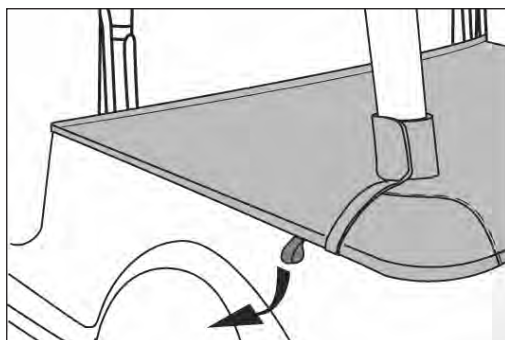

TO REMOVE TONNO COVER
Use the loops sewn to the fabric to release the plastic strips. Pull gently down, then straight out to release the plastic strip from the retainers.

IF YOU HAVE A QUADRATOP CLEARVIEW WINDSTOPPER:
Please refer to Windstopper instructions for steps to best secure it to your QuadraTop Tonno Cargo Cover.



The Trusted Source

Care and Maintenance:

Your QuadraTop accessory is made of the finest materials available but to keep it looking new and for the maximum possible wear, it will need periodic cleaning and basic maintenance. The main threats to your soft top are pollutants, dirt and grime. By keeping your product clean you will prolong its life. We recommend the following to keep your top like new:

Washing: The soft top fabric should be washed often using a mild soap, warm water and a soft bristle brush. You can also use special soft top cleaners available on our website at quadratec.com. Make sure that after cleaning you rinse with clear water to remove all traces of soap to avoid residue.

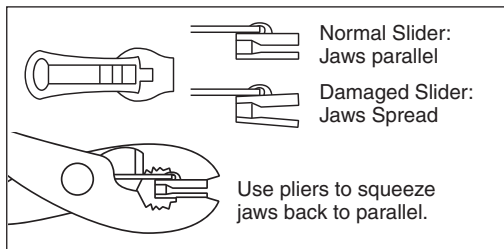

Zippers: Keeping the zipper cleaned and lubricated with a silicone lubricant (available online) will help prevent damage and keep the zippers in a smooth working condition. If zipper opens behind the slider, the slider may have been spread apart. This problem can usually be fixed by using an ordinary pair of pliers to bring the sides back into parallel. Return slider to the end of the zipper in the normal Open position. Squeeze lightly at first and test zipper. If the zipper continues to remain open squeeze more firmly with pliers and try the zipper again. Repeat procedure until your zipper operates correctly.

Water/Fabric: In the event of seeping through the seams, 3M Scotchgard® may be applied on the inside of the seams to stop the leak. Rips in the fabric may be repaired with Bondex® iron on patches. Iron the patches to the Inside of the top, carefully following the Bondex® instructions.

Snaps: Not all models have snaps. If present, keep snaps cleaned and lubricated with silicone to help prevent snaps from sticking to the studs. If a snap does become stuck to a stud, use a screwdriver and GENTLY pry apart to prevent permanent damage to the snap or the top fabric.



The Trusted Source

NEW! QuadraTop®



Key QuadraTop Features

1. Fabric: Tough 23 ounce mildew and UV resistant vinyl coated polyester and cotton fabric provides lasting durability and is backed by a limited three year warranty. QuadraTops are available in factory original colors and textures to keep your Jeep® looking showroom new!

2. Stitching: Our QuadraTop panels are sewn together with marine grade 135 gauge bonded Anefil® polyester thread that's super strong and UV protected. This rot resistant thread will provide years of worry free durability.

3. Seams: All exposed QuadraTop seams feature heat tape seals over double stitching to keep moisture out.

4. Windows: QuadraTops are available with your choice of zip out crystal clear windows or rear and quarter windows with a dark 31% tint keeping interiors much cooler in hot summer months. Our glass panels are 30mil thick and DOT approved for the ultimate in clarity and durability and feature leak proof heat seals. All windows are completely removable for open air enjoyment.

5. Zippers: QuadraTop window zippers are stitched in place like the original tops and feature jam resistant technology and heavy duty plastic teeth. Side quarter windows feature single metal pulls while the rear glass zippers have user friendly double pulls.

6. Hook & Loop Attachment: Our patterns are fully tested to ensure a tight and wrinkle free fit like the originals. All necessary snaps and Heavy Duty Hook & Loop strips are in place to install over the factory bows and there's never any drilling or modifications required!

7. Belt Rail System: Each QuadraTop utilizes the original belt rail attachment methods for a fit that's as tight as a drum!

8. Upper Door Skins: Our fabric upper doors install in just minutes onto your existing factory upper door frames by hook and loop fastener strips. It's quick and easy with our step by step illustrated instructions. Fabric upper doors have double sided weather strip bulb seals and double window zipper pulls. Note: Wranglers with half steel doors only feature clear upper door windows to meet federal and state requirements.

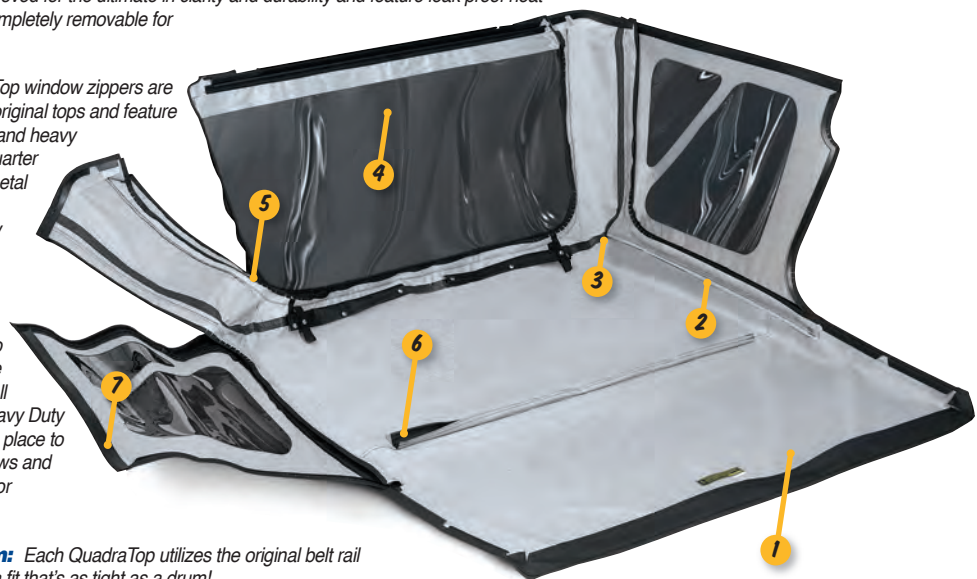

The Trusted Source

QuadraTop® Replacement Soft Tops

Affordable quality and durability with no compromises! Our top kits are designed to work with factory hardware and feature finer quality materials and workmanship along with the latest in manufacturing technologies for unprecedented value. Our new product team with decades of soft top knowledge and experience delivers you all the great features you want in a replacement top with unsurpassed customer service and support. Our QuadraTop is the best value in replacement soft tops compared to other tops costing hundreds more. If for any reason, you are not completely satisfied with your soft top purchase or have an installation question, please contact our professional customer support staff for a solution. All QuadraTops feature a limited Three year warranty against defects. The incredible fit & detailed instructions make installation as easy as... One, Two, Three!

Applications for YJ and TJ Wrangler Vehicles:

For '88-'95 Wrangler w/Upper Doors & Clear Windows #11000.00XX

For '88-'95 Wrangler w/Upper Doors & Tinted Windows #11000.01XX

▶ Colors: 09 · 15 · 17

For '97-'02 Wrangler w/Clear Windows #11000.02XX

For '97-'02 Wrangler w/Tinted Windows #11000.03XX

For '97-'02 Wrangler w/Upper Doors & Clear Windows #11000.04XX

For '97-'02 Wrangler w/Upper Doors & Tinted Windows #11000.05XX

▶ Colors: 15 · 17 · 33

For '03-'06 Wrangler w/Clear Windows #11000.0635

For '03-'06 Wrangler w/Tinted Windows #11000.0735

For '03-'06 Wrangler w/Upper Doors & Clear Windows #11000.0645

For '03-'06 Wrangler w/Upper Doors & Tinted Windows #11000.0745

▶ Colors: 35



**QUADRATOPS
START AT
\$299.99!**

to the RESCUE!

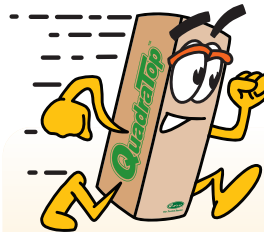

SAME DAY SHIPPING!*

**Factory Trained Soft Top
Advisors Always on Call!**



Go online or call for latest price...

**AFFORDABLE
QUALITY
WITH NO COMPROMISES!**



Due to the limitations of printing, all color samples shown in this catalog are close approximations only.



*Order an In Stock New QuadraTop Soft Top for Delivery in the Lower 48 States Before 4pm Eastern Standard Time, and It'll Ship UPS Ground the Same Day. Ground Shipments take between 1-7 Business Days to Deliver. Need Your Top Faster? Expedited Shipping Options are Available with a UPS Air Freight Surcharge.



The Trusted Source

Quadratec Limited Warranty

for QuadraTop® Tonno Cover

Your QuadraTop Tonno Cover is covered by the following **Limited Warranty** provided exclusively by Quadratec, Inc. 1028 Saunders Lane, West Chester, PA 19380.

This **Limited Warranty** is the only warranty made in connection with purchase. Quadratec neither assumes nor authorizes any vendor, retailer or other person or entity to assume for it any other obligation or liability in connection with this product or **Limited Warranty**.

What is Covered:

Subject to the terms, exclusions and limitations herein and with respect only to soft goods accessories first sold in the United States, Quadratec warrants to the initial retail purchaser only that your QuadraTop Tonno Cover shall be free of defects in material and workmanship **for a period of 3 years from date of initial retail sale.**

All other warranties are hereby disclaimed, except to the extent prohibited by applicable law in which case any implied warranty of merchantability or fitness for a particular purpose on this product is limited to 3 years from date of initial retail sale. Quadratec reserves the rights to: (a.) require invoice or other proof that your product is within the terms of this **Limited Warranty** as a condition of warranty service and, (b.) make future revisions to this product and **Limited Warranty** without prior notice or obligation to upgrade your product.

What is Not Covered:

Your Quadratec **Limited Warranty** does not cover products or parts Quadratec determines to have been damaged by or subjected to: (a.) installation damage, alteration, modification, failure to maintain or attempted repair or service by anyone not authorized by Quadratec, (b.) normal wear and tear, cosmetic damage or damage from water immersion, (c.) Acts of God, accidents, misuse, negligence, inadequate mounting or impact with vehicle(s), obstacles or other aspects of the environment, (d.) theft, vandalism or other intentional damage.

Remedy Limited to Repair/Replacement:

The exclusive remedy provided hereunder shall, upon Quadratec inspection and at Quadratec's option, be either repair or replacement of product or parts (new or refurbished) covered under this Limited Warranty. Customers requesting warranty consideration on QuadraTop soft top should first contact Quadratec to obtain a RGA number (610-701-3336). All labor, removal, shipping and installation costs are customer's responsibility.

Other Limitations - Exclusion of Damages

- Your Rights Under State Law:

In consideration of the purchase price paid, neither Quadratec nor any independent Quadratec distributor/licensee are responsible for any time loss, rental costs, or for any incidental, consequential, punitive or other damages you may have or incur in connection with any part or product purchased. Your exclusive remedy hereunder for covered parts is repair/replacement as described above.

This **Limited Warranty** gives you specific rights. You may also have other rights that vary from state to state. For example, some states do not allow limitations of how long an implied warranty lasts and/or do not allow the exclusion or limitation of incidental or consequential damages, so the limitations and exclusions herein may not apply to you.

©Quadratec, Inc. 2013. All Rights Reserved.

Version 12.02.13 A4

The terms Quadratec®, QuadraTop®, Essentials® and Essential® are Registered Trademarks of Quadratec Inc. Registered in U.S. Patent and Trademark Office.

Part #12999.8006



The Trusted Source