







Installation Instructions





KNOCK DOWN INSTATRUNK™

Vehicle Application:

- Jeep® Wrangler and Wrangler Unlimited
- 2011 – Current
- Part Number: 42703

www.Bestop.com - We're here to help! Visit our web site and click on "Ask a Question". Click here for more [Jeep® Accessories by Bestop](#).

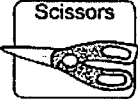
 3/4 Hour	    1 - Easy
--	--

 Torx Wrench T-30	 Flat-Head Screwdriver	 Scissors	 Safety Glasses
--	--	---	---

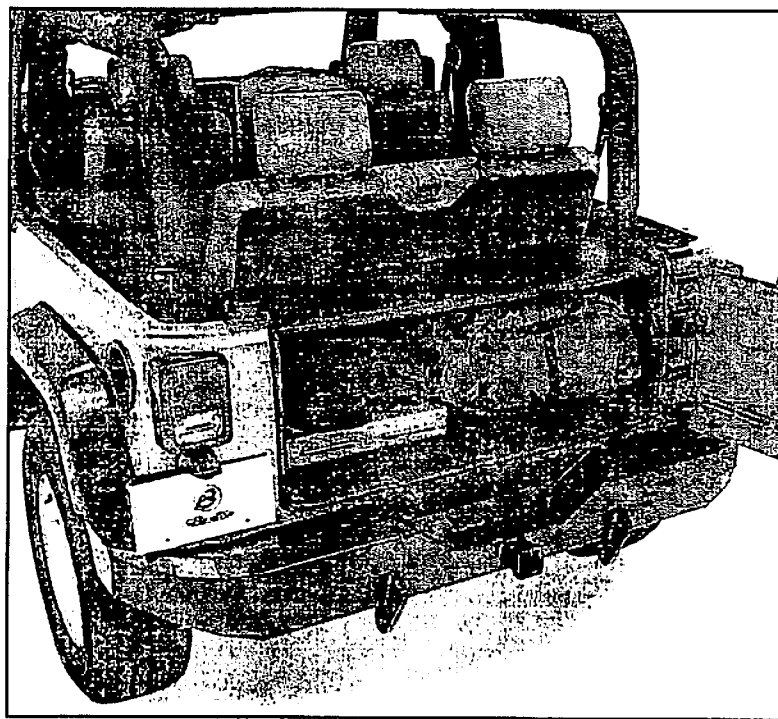

⚠ WARNING This product is designed primarily to enhance the appearance of the vehicle. Do not rely in any way on the components of this product to protect against injury or death in the event of an accident. Never operate the vehicle in excess of manufacturer's specifications.

WEAR SEAT BELTS AT ALL TIMES

Read and follow, precisely, all installation instructions provided when installing product. Failure to do so may result in a poor fit and could place occupants of the vehicle in a potentially dangerous situation.

KNOCK DOWN INSTATRUNK™ Installation Instructions

Parts List

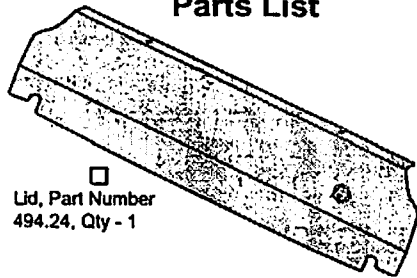

□
Lid, Part Number
494.24, Qty - 1

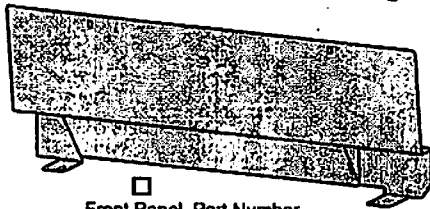

□
Front Panel, Part Number
494.25, Qty - 1

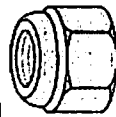

□
M8-1.25 Hex Lock Nut,
Part Number 434.12,
Qty - 2

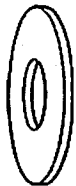

□
M10 Flat Washer, Part
Number 481.58, Qty - 2

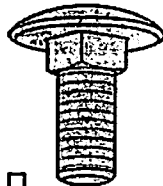

□
M8-1.225 x 20mm Carriage
Bolt, Part Number 497.58,
Qty - 2

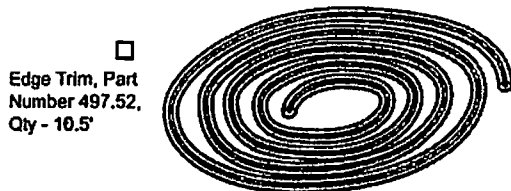

□
Edge Trim, Part
Number 497.52,
Qty - 10.5'

1 Loosen Cargo Loop Bolts

Open the tailgate and lift the rear window. If installing on a 2 Door Wrangler, tumble the rear seat forward for more room to work.

Use a T-30 Torx driver to loosen the two (2) rear cargo loop bolts on each side of the rear storage compartment. Remove the two (2) cargo loop bolts that are located next to the rear loops.

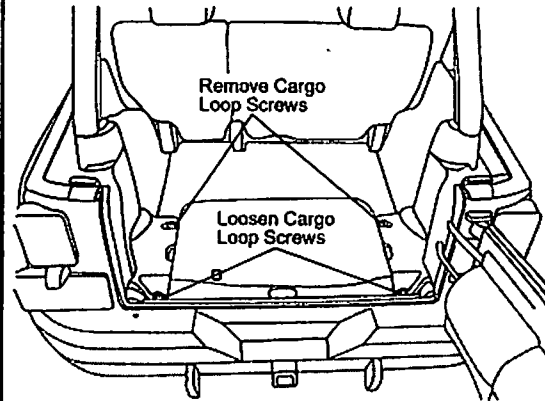

2 Install Edge Trim on Front Panel

Install Edge Trim on each side of the Front Panel and trim to fit.

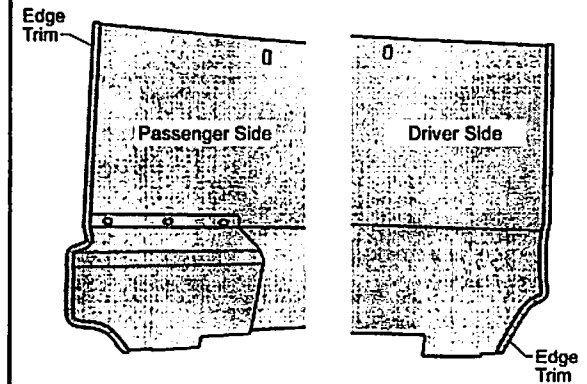

KNOCK DOWN INSTATRUNK™ Installation Instructions



Install Front Panel

Orient the Front Panel in the cargo area with the bottom mounting flanges pointing rearward. Position the panel so the mounting flanges are in front of the plastic cargo side panels (and sub woofer if so equipped). Lift the plastic side panels up slightly with a flat head screwdriver and slide the front panel flanges under the plastic panels. Line up the slots in the panel mounting flange with the cargo loop bolt hole. Reinstall the two cargo loops and bolts and leave the bolts loose.

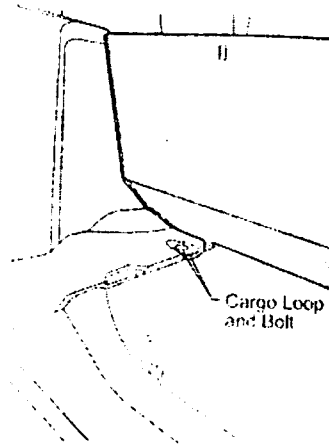

Install Edge Trim on Lid

Install Edge Trim on the sides and rear edge of the Lid and trim to fit.

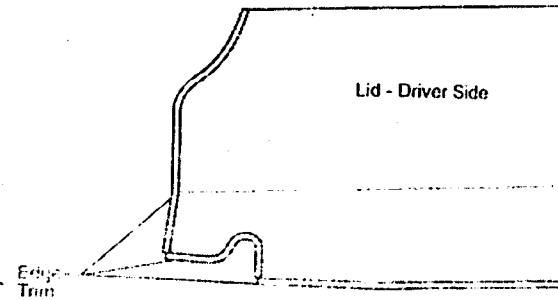

Install Lid

To install the lid, tip the rear edge downward and position the rear outboard tabs under the lip on the top of the Jeep body. Rotate the front of the Lid downward so it overlaps the Front Panel.

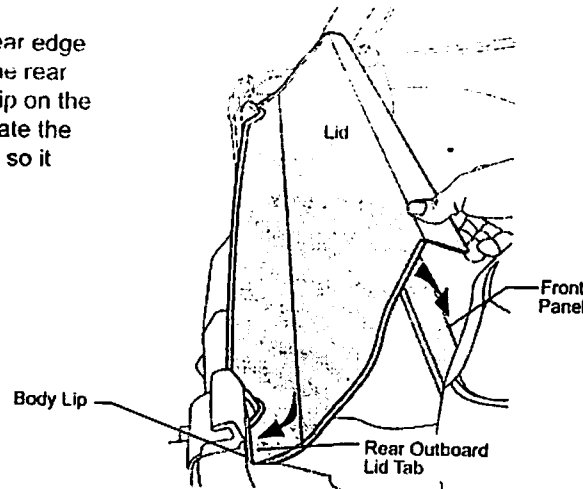

Secure Lid to Front Panel

From the front of the Instatrunk insert a Carriage Bolt through a slot in the Lid and Front Panel. Hold the Carriage Bolt in place with a Flat Washer and Lock Nut. Repeat on the other slot. Put the back seat in the upright position on 2 door models. Adjust the panel location if necessary and then fully tighten the Carriage bolts and cargo loop bolts on the floor.

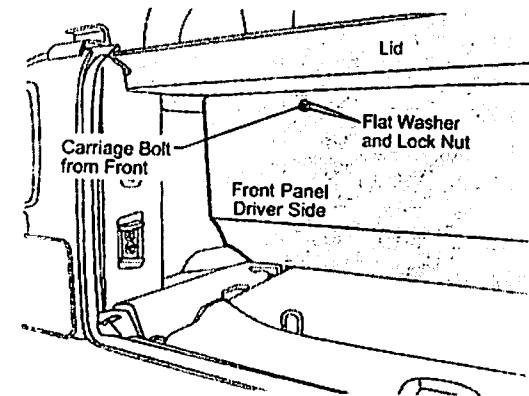

Knock Down INSTATRUNK™ Installation Instructions

LIMITED WARRANTY

We warrant our product to be free from defects in material and workmanship, for the terms specified below, provided there has been normal use and proper maintenance. This warranty applies to the original purchaser only. All remedies under this warranty are limited to the repair or replacement of any item or items found by the factory to be defective within the time period specified. If you have a warranty claim, first you must call our factory at the number below for instructions. You must retain proof of purchase and submit a copy with any items returned for warranty work. Upon completion of warranty work, if any, we will return the repaired or replaced item or items to you freight prepaid. Damage to our products caused by accidents, fire, vandalism, negligence, misinstallation, misuse, Acts of God, or by defective parts not manufactured by us, is not covered under this warranty.

THE WARRANTY TIME PERIOD IS AS FOLLOWS FOR REPLACE-A-TOP™, SAILCLOTH REPLACE-A-TOP™, SUPERTOP®, SUPERTOP® REPLACEMENT SKINS, SUNRIDER®, AND TIGERTOP®: TWO YEARS FROM DATE OF PURCHASE.

THE WARRANTY TIME PERIOD IS AS FOLLOWS FOR ALL OTHER "SOFT GOODS" MANUFACTURED BY OUR COMPANY (USING PRIMARILY VINYL, PLASTICS, AND/OR FOAM): ONE YEAR FROM DATE OF PURCHASE.

THE WARRANTY TIME PERIOD IS AS FOLLOWS FOR ALL OTHER "HARD GOODS" MANUFACTURED BY OUR COMPANY (USING PRIMARILY METALS, PLASTICS, AND/OR FIBERGLASS): ONE YEAR FROM DATE OF PURCHASE.

ANY IMPLIED WARRANTIES OF MERCHANTABILITY AND/OR FITNESS FOR A PARTICULAR PURPOSE CREATED HEREBY ARE LIMITED IN DURATION TO THE SAME DURATION AND SCOPE AS THE EXPRESS WRITTEN WARRANTY. OUR COMPANY SHALL NOT BE LIABLE FOR ANY INCIDENTAL OR CONSEQUENTIAL DAMAGE.

Some states do not allow limitations on how long an implied warranty lasts, or the exclusion or limitation of incidental or consequential damages, so the above limitations or exclusions may not apply to you. This warranty gives you specific legal rights, and you may also have other rights which vary from state to state.



For further information or request for warranty work, please contact:
Bestop Inc. Customer Service
Toll-Free: (800)845-3567
Main: (303)465-1755
E-mail: csbestop@Bestop.com
Website: www.Bestop.com