

QuadraTop® Bimini Top and Bimini Top Plus

Installation Manual for '97-'06 Jeep® TJ Wrangler Vehicles
#11022.XXX5 and #11022.1XXX



⚠ WARNING ⚠

Loss of vehicle control involves risk of death or serious injury, particularly to parts of your body not restrained within vehicle. This product is intended for weather protection only and should not be relied upon to contain occupants in the event of an accident or to protect from either ground contact or falling objects. To reduce risk of accident or injury:

- **ALWAYS WEAR SEATBELTS**
- Always keep head, arms & body parts within vehicle.
- Fully secure or stow the fabric top before driving according to instructions. Never try to adjust the fabric top while driving. Do not use if damaged or worn.
- Read and follow all instructions & warnings accompanying this product, in your vehicle owner's manual and Off Road Driving Supplement.

⚠ CAUTION ⚠

RISK OF EYE INJURY. Safety glasses should be worn at all times while installing or maintaining this product.

PARTS LIST:

FABRIC TOP - QTY 1
D-RING WEB STRAP* - QTY 2
*FOR 03-06 BIMINI TOPS ONLY

REQUIRED TOOLS:

SAFETY GLASSES
T-30 TORX WRENCH*



The Trusted Source

Important Safety Information:

Your QuadraTop® Bimini Top/Bimini Top Plus is intended to increase the fair weather enjoyment of your off-road capable vehicle. Before installation, please take a moment to review the

following safety information and installation instructions. Important safety information is generally preceded by one of three signal words indicating the relative risk of injury. The signal words mean:

⚠ WARNING ⚠

a hazardous situation which, if not avoided, could result in death or serious injury. You CAN be KILLED or SERIOUSLY HURT if you don't follow instructions.

⚠ CAUTION ⚠

a hazardous situation which, if not avoided, could result in minor or moderate injury. You CAN be moderately HURT and also may suffer property damage if you don't follow instructions.

NOTICE

Careful attention is required to this instruction or operation but does generally not relate to personal injury. Damage to your Quadratec® product or other property may result if you don't follow instructions.

Before You Begin Installation:

Congratulations on your purchase of the QuadraTop Bimini or Bimini Plus Top! This high quality brief top is designed to enhance fair weather driving pleasure while providing shade and minimal shelter from light rain. We have used only the finest materials in creating this top but like any product that is exposed to the elements, there is some general maintenance that is required to keep it looking like new. Please see page 7 for these important maintenance tips. Thank you again for your purchase and let's start the installation process!

When unpacking, check to make sure all parts are included. If any part is missing or broken, please call Quadratec Customer Service at 800-745-6037 as soon as possible.

Important: Make sure you become familiar with the installation process of this top by reading the following instruction sheet thoroughly.



Important: For a smooth fit and ease of installation, this top should be installed at temperatures above 72 degrees. Below this temperature, the fabric may contract an inch or more making it difficult to install. We highly recommend taking the top out of the package and letting it sit inside a warm place or direct sun light for 1-2 hours before you install the top. When warm, this top will install quickly.

It is normal for fabric to contract and wrinkle when stored in the shipping carton. In a few days the fabric will relax and wrinkles will disappear.



The Trusted Source

Before Installation: All Models

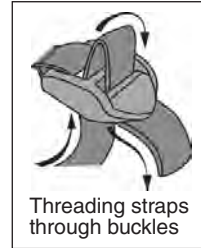

Windshield Channel Requirements

All Bimini tops are designed to fit into a required windshield channel. You may already have the correct one. Compare yours to photo above. If it is not the same, get #11122.02 at quadratec.com

Threading Straps Through Buckles:

Throughout the installation, you will need to thread the straps through the buckles several times. Please review the diagram above for correct strap routing through the buckles.

NOTICE For best possible installation, check to make sure the Bimini Top or Bimini Top Plus is perfectly centered on the vehicle.

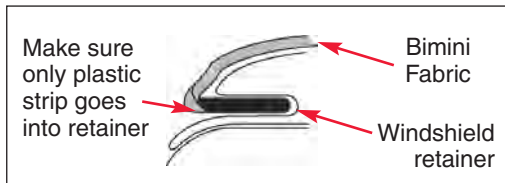

Step One: Installation for '97-'06 TJ

LOCATE BIMINI TOP ONTO CHANNEL
Put on safety glasses. Orient Bimini Top or Bimini Plus on the vehicle and drape it over the bows. Insert the plastic strip sewn along the front of the Bimini into the windshield channel. Do not catch the fabric in the channel. Center the Bimini on the vehicle so that it is an equal distance from the top of the windshield flange on both sides, as shown below.

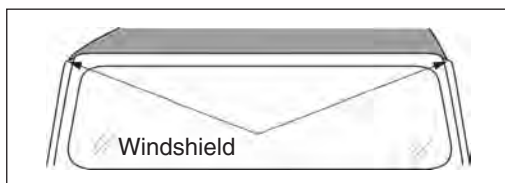
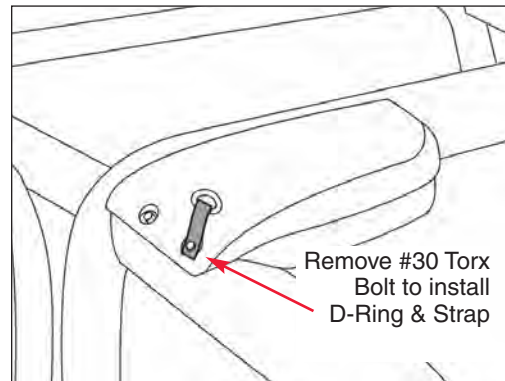

Step One B: For '03-'06 TJ Bimini only

INSTALL D-RING WEB STRAPS

Locate the D-Ring Web Straps in the parts kit. Use the #30 Torx to remove the bolt at the rear of the speaker pod on each side of the vehicle. Thread a bolt through the hole in each D-Ring Web Strap and reinstall the bolts in the holes in the speaker pods. Do not tighten them at this time. **NOTE:** This does not apply to Bimini Plus for '03-'06 vehicles.



The Trusted Source

Step Two: Installation for all '97-'06 TJ

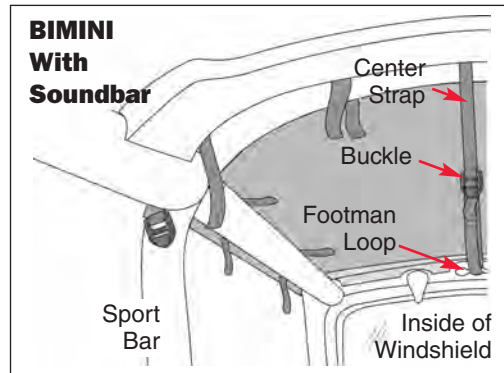
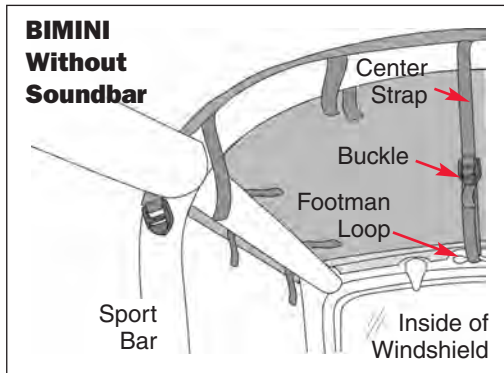

FASTEN CENTER STRAP

For all versions, drape fabric over the sport bar. The goal in this step is to wrap the long center strap around the vehicle's sport bar (main hoop) to bring it forward and through the footman

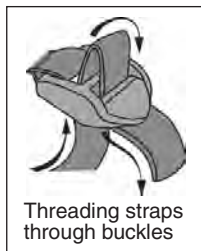

loop on the windshield. Then, pull the end of strap back and thread it (as shown in diagram) through the attached buckle.

Tighten main strap securely. Make sure all side & rear straps and buckles (at door opening and sportbar) surround the bar it is intended to wrap, but do not close them at this time.

For vehicles with a Soundbar

With the long center strap resting on top of the soundbar. Push the end of the center strap between the sport bar and

the soundbar. Push the end of the strap through until you can get a hold of the strap to pull the buckle through. Wrap the center strap inside the top around the sport bar, pull the strap forward to the windshield. Thread the strap through the footman loop on the windshield frame. Then pull the end of the strap back and thread it through the buckle. Tighten it securely.

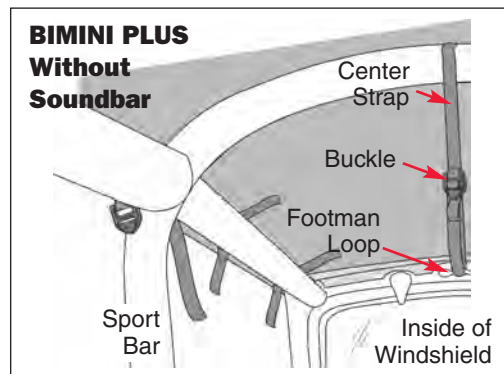

NOTICE

Some soundbars fit very tightly against the sport bar, preventing the buckles from passing between the soundbar and the sportbar. If this is the case with your vehicle, Soundbar may need to be moved slightly rearward.

If needed, loosen the 4 bolts that position the soundbar and slightly re-position the soundbar rearward to allow the straps with buckles to pass between sport bar and soundbar. Re-tighten bolts in new soundbar position.



The Trusted Source

Step Three: for '97-'06 Bimini/Bimini Plus

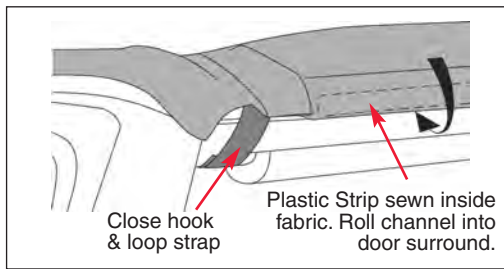

the hook strip tucked inside of the rail to hold fabric in place. Tuck inside flap between the Door Surround and the Bimini top fabric.

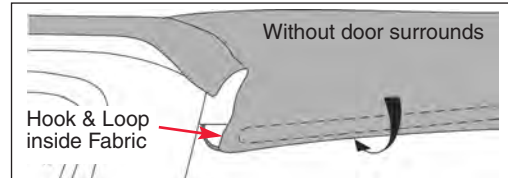

WITH DOOR SURROUNDS

SECURE BIMINI ABOVE DOORS

Locate the hook & loop strips sewn to the front corners of top. Tuck the hook strip between the horizontal sport bar and Door Surround. Locate plastic strip sewn along the edge of outer flap, above the door opening. Slip the plastic strip into the channel on the Door Surround. Fold fabric insert from front to back, so that it lays flat on top of the horizontal sport bar and wrap the outer loop strip around Door Surround and fasten it to

WITHOUT DOOR SURROUNDS

FASTEN FLAPS ABOVE DOORS

Locate hook & loop strips sewn to the front corners of the top. Fasten the strips to each other & tuck them up above the horizontal sport bar, out of the way. Locate flap sewn inside Bimini above door opening. Wrap the inside and outside flaps around horizontal sport bar and fasten Hook & Loop Strips to each other.

Step Three: For '97-'02 TJ Bimini (only)

SECURE MAIN SPORT BAR STRAPS

Bimini For '97-'02 Vehicles ONLY:

Wrap the straps sewn to the rear corners around the rear sport bar and then thread them through the buckles on the rear corners of the Bimini. Locate the sets of hook & loop straps on the rear of the Bimini and wrap & close around the center (main hoop) sport bar.

'97-'02 Bimini install complete!

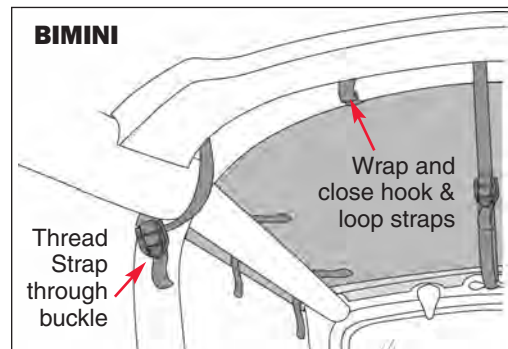

Step Four:

For Step 4 for both Bimini and Bimini Plus, Please see page 6.



The Trusted Source

Step Four: for '03-'06 TJ Bimini (only)

FASTEN REAR STRAPS

For Bimini: Locate the two straps sewn at an angle to the rear of the Bimini on each side of the center strap. Thread the end of each strap through the D-ring on the strap installed during step one. Thread the strap into the ring from underneath. Then pull the end of the strap back and thread it through the buckle sewn to the strap. When alignment of the D-Ring web strap is established, use the #30 Torx from Step One B to tighten bolt. Tighten web strap at the buckle.

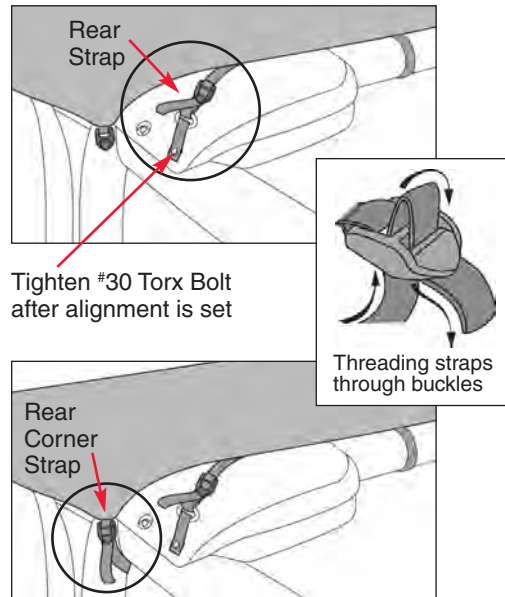

FASTEN REAR CORNER STRAPS

For Bimini: Wrap the straps sewn to rear corners around the sport bar and thread them through the buckles on the rear corners of the Bimini.
'03-'06 Bimini Install complete!

Step Four: for '97-'06 Bimini Plus (only)

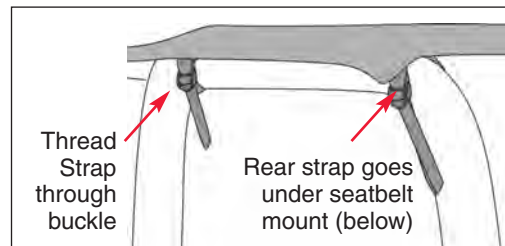
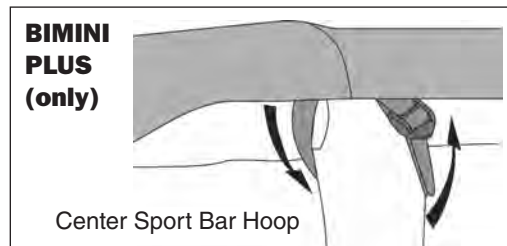

SECURE ALL BIMINI PLUS STRAPS

Wrap the straps sewn to the side of the Bimini Plus around the sport bar and thread it through the buckle on the other side of the sport bar. Then locate the buckles and straps sewn to the rear corners of the Bimini Plus. Wrap the straps around the rear sport bars and under the seat belt mounts. Thread the ends through the buckles and pull them tight. **Bimini Plus install now complete.**

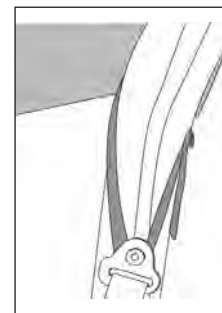
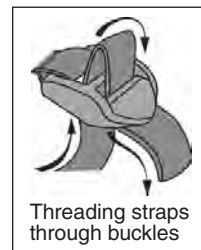

The Trusted Source



Care and Maintenance:

Your Quadratec Bimini Top is made of the finest materials available but to keep it looking new and for the maximum possible wear, it will need periodic cleaning and basic maintenance. The main threat to your soft top are pollutants, dirt and grime. By keeping your soft top clean you will prolong the life of your top. We recommend the following to keep your top like new:

Washing: *The soft top fabric should be washed often using a mild soap, warm water and a soft bristle brush. You can also use special soft top cleaners available on our website at quadratec.com. Make sure that after cleaning you rinse with clear water to remove all traces of soap to avoid residue.*

Water/Fabric: *In the event of seeping through the seams, 3M Scotchgard® may be applied on the inside of the seams to stop the see. Rips in the fabric may be repaired with Bondex® iron on patches. Iron the patches to the Inside of the top, carefully following the Bondex® instructions.*

Snaps: *Not all models have snaps. If present, keep snaps cleaned and lubricated with silicone to help prevent snaps from sticking to the studs. If a snap does become stuck to a stud, use a screwdriver and GENTLY pry apart to prevent permanent damage to the snap or the top fabric.*



The Trusted Source

Quadratec Limited Warranty

for QuadraTop® Bimini & Bimini Plus Soft Sun Tops

Your QuadraTop Bimini top is covered by the following **Limited Warranty** provided exclusively by Quadratec, Inc. 1028 Saunders Lane, West Chester, PA 19380.

This **Limited Warranty** is the only warranty made in connection with purchase. Quadratec neither assumes nor authorizes any vendor, retailer or other person or entity to assume for it any other obligation or liability in connection with this product or **Limited Warranty**.

What is Covered:

Subject to the terms, exclusions and limitations herein and with respect only to soft tops first sold in the United States, Quadratec warrants to the initial retail purchaser only that your QuadraTop Bimini top/Bimini Top Plus shall be free of defects in material and workmanship **for a period of 3 years from date of initial retail sale**.

All other warranties are hereby disclaimed, except to the extent prohibited by applicable law in which case any implied warranty of merchantability or fitness for a particular purpose on this product is limited to 3 years from date of initial retail sale. Quadratec reserves the rights to: (a.) require invoice or other proof your product is within the terms of this **Limited Warranty** as a condition of warranty service and, (b.) make future revisions to this product and **Limited Warranty** without prior notice or obligation to upgrade your product.

What is Not Covered:

Your Quadratec **Limited Warranty** does not cover products or parts Quadratec determines to have been damaged by or subjected to: (a.) installation damage, alteration, modification, failure to maintain or attempted repair or service by anyone not authorized by Quadratec, (b.) normal wear and tear, cosmetic damage or damage from water immersion, (c.) Acts of God, accidents, misuse, negligence, inadequate mounting or impact with vehicle(s), obstacles or other aspects of the environment, (d.) theft, vandalism or other intentional damage.

Remedy Limited to Repair/Replacement:

The exclusive remedy provided hereunder shall, upon Quadratec inspection and at Quadratec's option, be either repair or replacement of product or parts (new or refurbished) covered under this Limited Warranty. Customers requesting warranty consideration on QuadraTop soft top should first contact Quadratec to obtain a RGA number (610-701-3336). All labor, removal, shipping and installation costs are customer's responsibility.

Other Limitations - Exclusion of Damages - Your Rights Under State Law:

In consideration of the purchase price paid, neither Quadratec nor any independent Quadratec distributor/licensee are responsible for any time loss, rental costs, or for any incidental, consequential, punitive or other damages you may have or incur in connection with any part or product purchased. Your exclusive remedy hereunder for covered parts is repair/replacement as described above.

This **Limited Warranty** gives you specific rights. You may also have other rights that vary from state to state. For example, some states do not allow limitations of how long an implied warranty lasts and/or do not allow the exclusion or limitation of incidental or consequential damages, so the limitations and exclusions herein may not apply to you.

©Quadratec, Inc. 2013. All Rights Reserved.
Version 12.02.13 A4

The terms Quadratec®, QuadraTop®, Essentials® and Essential® are Registered Trademarks of Quadratec Inc. Registered in U.S. Patent and Trademark Office.

Part #12999.8002



The Trusted Source