



## Installation Instructions Addendum Complete Frameless Trail Top 2007-2015 JK Wrangler 2 door

**NOTE:** Installation of the top in warm weather is optimal for ease of installation. Ideal installation temperature should not be less than 70° (21C). Initial installation is the most difficult as the fabric has not been stretched. The top will loosen slightly with use and warm temperature. Allow about at least an hour for the initial installation.  
\*\*\*Please follow instructions for ease of installation and correct fit.\*\*\*

### Included:

- 1 x Top components (Top, side windows, Rear window, window storage bag and 4 x Aluminum poles)
- 1 x Tailgate Bar Kit (Bar w/ brackets)
- 1 x Door Surround Kit
- 1 x Header Channel (Channel w/ clamps)

### Required Tools:

Phillips screw driver to remove original soft top. Torx sockets are required to completely remove the original soft top hardware.

- Step 1.** Remove existing soft or hard top as per the OEM procedures.
- Step 2.** Install the Door Surround Kit per the instructions included in the sub-kit.
- Step 3.** Assemble the Tailgate Bar Brackets. Slide the backing onto the housing as seen in Figure 1 until the backing is flush on both sides. Install two screws into each bracket set. Use the pre-drilled holes in the housing as a guide for the self-tapping screws to screw into the backing. Install the Tailgate Bar brackets onto the vehicle as shown in Figure 2 and 3.
- Step 4.** Install the Frameless Trail Top and Header Channel per the instructions included in the sub-kit.
- Step 5.** Slide the Tailgate Bar onto the bottom of the rear window. The Tailgate Bar has a C channel (See Figure 4) built into it, slide this onto the flap with a small tube at the bottom of the window. See Figure 5. Center the Tailgate bar to the window.
- Step 6.** Insert the Tailgate Bar into the brackets by pushing the bar against the brackets and pivoting.

Figure 1

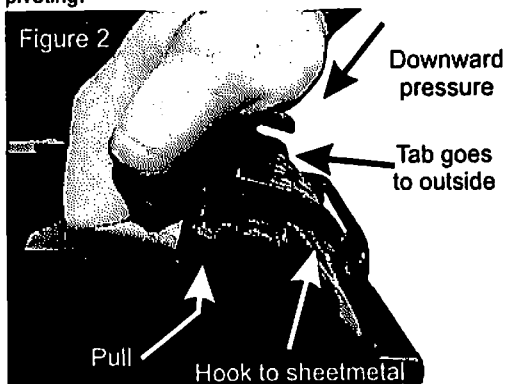
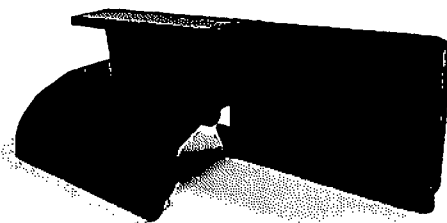

Figure 3

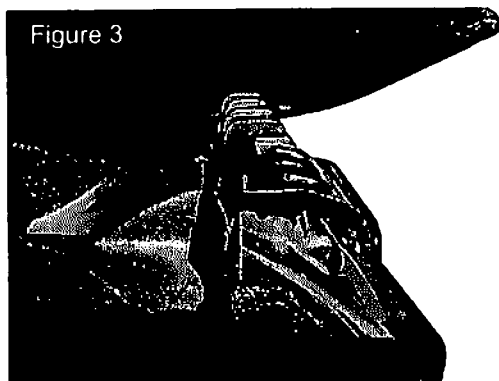

Figure 4

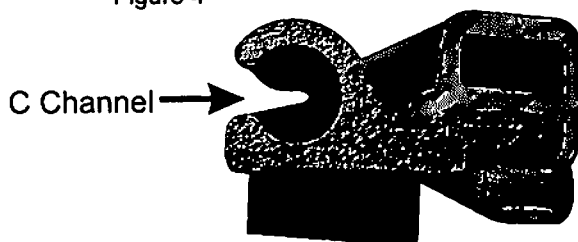
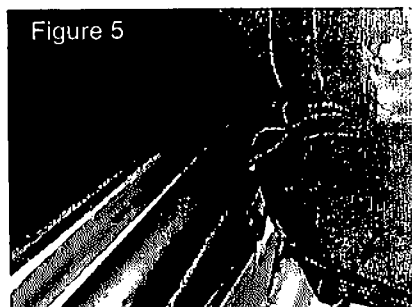

Figure 5



**Enjoy your Rampage Products Complete Frameless Top!**

Rampage Products Corona, CA 92883  
Phone: (951) 277-4949 Fax: (951) 277-2295  
www.rampageproducts.com  
Made in China



## Installation Instructions

61099 Door Surrounds

2 Door Jeep JK - All

Included:  
left upright  
Right upright  
Left top section  
Right top section

4 x large knob (long shaft)  
2 x small knob

**PLEASE READ ALL INSTRUCTIONS AND BE SURE YOU HAVE A CLEAR UNDERSTANDING BEFORE BEGINNING THIS INSTALLATION**

### Overview

The door surrounds are intended to be used with the Rampage Frameless Top and Factory Replacement Tops in place of the factory door surrounds. They can be used with factory tops but may limit the functionality of some factory top features such as the folding front mechanisms. They have been designed to strengthen some of the weak areas of the factory door surrounds and provide a simple and sturdy mount specifically for our Rampage tops.

- 1) Insert left upright into left top section and use small knob to lock the two parts together.
- 2) Use the large knobs with the long shafts on the front and rear locations to attach the surround to the vehicle.  
**NOTE:** It is easiest to insert the plastic foot on the upright into the mount point on the body of the vehicle first before slipping the top mounts onto the roll bar.
- 3) Repeat installation for other side.

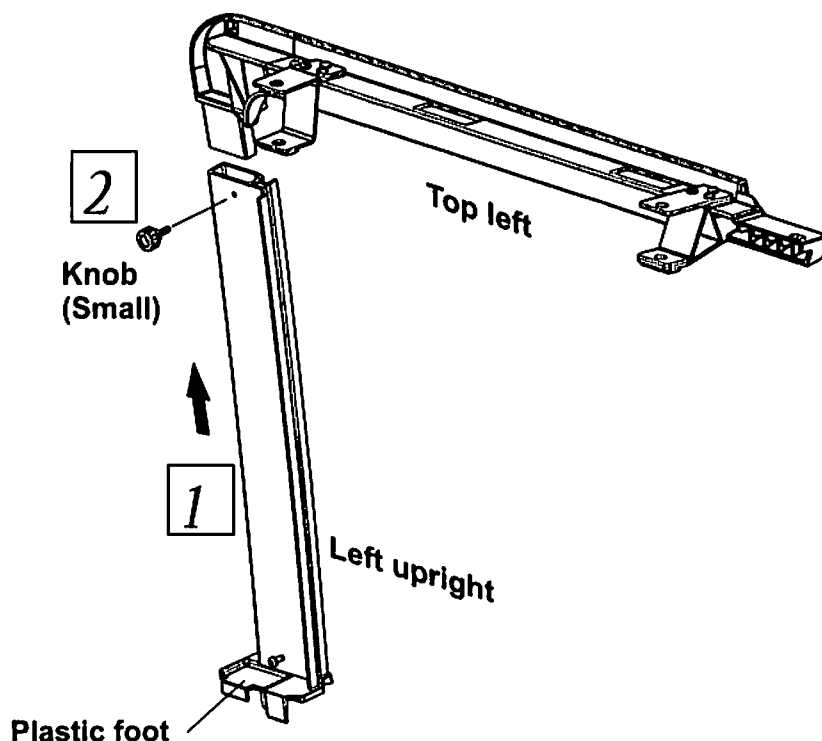

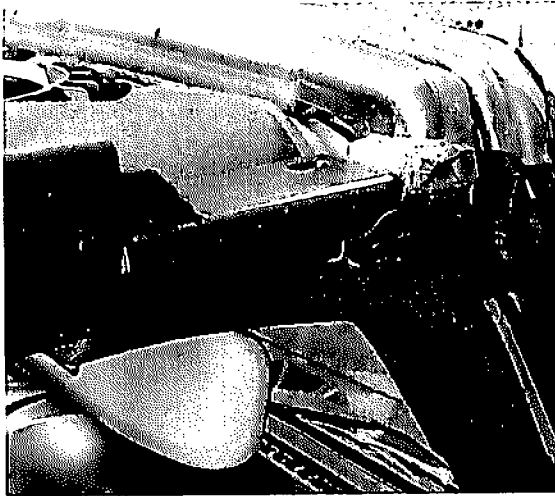

**NOTE: Pay close attention to the rubber gasket at the top of the windshield and how the front section inserts into it. The picture to the left shows how it should fit.**

#### **Warranty Information**

Rampage products, Inc. warrants to the original purchaser of any step product it manufactures, that the product will be free of defects in material or workmanship for a period of 1 year from date of purchase. Such obligations under this warranty shall be limited to the repair or replacement, at Rampage products discretion, of any assembly or parts which, upon examination by Rampage products, Inc. proves to be defective. All defective items must be returned with proof of purchase to Rampage products, Inc., freight prepaid. This warranty does not cover damage resulting from abuse, misuse, alteration, accident or damage in transit. Rampage products obligations under this warranty are limited to the aforementioned repair or replacement of warranty defects for which the return authorization has been received during the warranty period, and Rampage products, Inc. shall not be liable for any incidental or consequential damages arising from breach of this or any implied warranty.

**Rampage Products, Corona, CA Phone: (951) 277-4949 Fax: (951) 277-2295  
[www.rampageproducts.com](http://www.rampageproducts.com)**



## Installation Instructions

Part number 1099XX, Frameless Soft Top  
for  
2 door Jeep® Wrangler JK 2007-

**NOTE:** Installation of the top in warm weather is optimal for ease of installation. Ideal installation temperature should not be less than 70° (21C). Initial installation is the most difficult as the fabric has not been stretched. The top will loosen slightly with use and warm temperature. Allow about at least an hour for the initial installation.

\*\*\*Please follow instructions for ease of installation and correct fit.\*\*\*

### Included:

- 1 x Top components (Top, side windows, Rear window, window storage bag)
- 2 x Aluminum poles

### Required Tools:

Phillips screw driver to remove original soft top. Torx sockets are required to completely remove the original soft top hardware.

- Step 1.** Remove existing soft or hard top. For OEM (original/factory) soft tops: remove header bar, remove tube frame hardware from roll bar, and remove the rear window/tailgate bar and set it aside for the new top. Keep the rear bar mounting hardware in place on the body as the rear bar will be re-used. Keep the door surrounds in place as they will also be used.
- Step 2.** Inspect the clearance between top of windshield frame and door surround, making sure that the factory foam seal is in place; door surrounds are properly placed and tightened per Jeep® owners manual. Inspect rear Tailgate Bar and Clips that they are securely mounted and they are in good working condition. **NOTE. The factory door surrounds have an extrusion that was added for the 2010 model year or later. This added extrusion must be removed to work with the Rampage Framless top. Please see Figure 1 below for further detail. You can also chose to use the Rampage door surrounds (available 2013) or a set of surrounds from a 2007-2009 JK. We recommend the use of the Rampage surround kit as it was designed specifically for this top.**

### For 2010 or later Door Surrounds

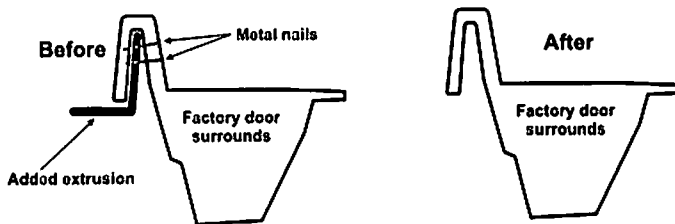

The 2010 model year or later has an added extrusion nailed into the original surround that needs to be removed to work properly with the Rampage Frameless Top. It is easily removed, the surrounds will still work fine with the factory top, and the extrusion can be quickly re-installed as desired. Simply pull the extrusion out from the nails or remove the nails themselves.

Figure 1

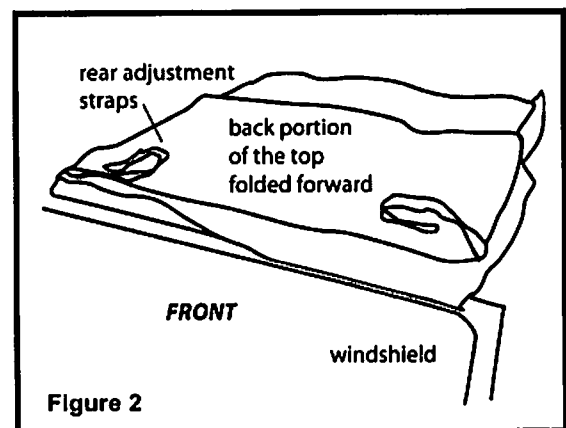

Figure 2

- Step 3.** Unfold your new Soft Top, set the windows aside for later use, taking care not to scratch windows. Place the top on the center of the roll bar and unfold. Spread the top out and taking care that the metal flat hooks at the end of the rear adjustment straps do not damage paint, glass or cause injury. See Figure 2.

**Step 4**

- a. Install the top onto the header channel using the snaps as shown in the illustration. (fig. 3 )
- b. Place the header channel with the top installed above the windshield on the gasket and fold the combo top forward over the windshield.
- c. Insert the tab of the header channel into the footman loop on the vehicles windshield frame as shown. (fig.4)

**Fig 3**

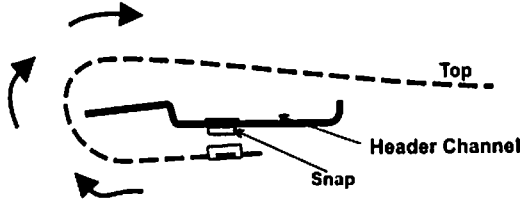

**Fig 4**

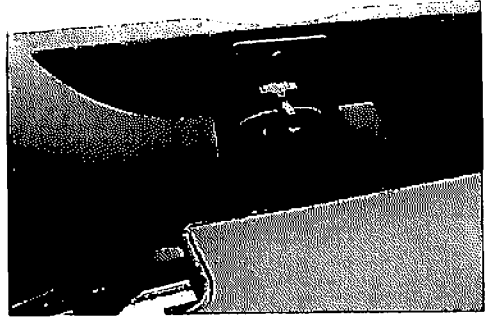

- d. Place the metal bracket in place on under the header channel as shown. (fig. 5).
- e. Insert the threaded knob into the metal bracket and tighten. (fig. 6) Repeat for other side.

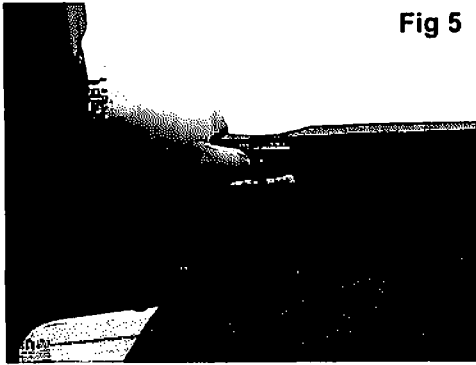

**Fig 5**

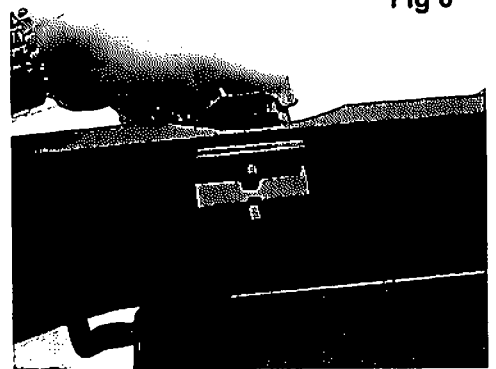

**Fig 6**

- Step 5.** Once the header channel and top have been installed on the windshield frame, fold the top back over the roll cage of the vehicle and spread it out. Insert plastic into the top of the door surround channels above either door opening. This will center the top at the front.

- Step 6.** Wrap the two straps at the center of the top main section around the rear of the main roll bar and hook the plastic hooks into the holes on the under side of the roll bar. Push the hooks into the hole and then pull back to hook the clip on the inside sheet metal. Tighten snugly so there is some tension on this strap. **NOTE: So as not to over tighten, do not use any tools to tighten this strap. See fig. 7 & 8.**

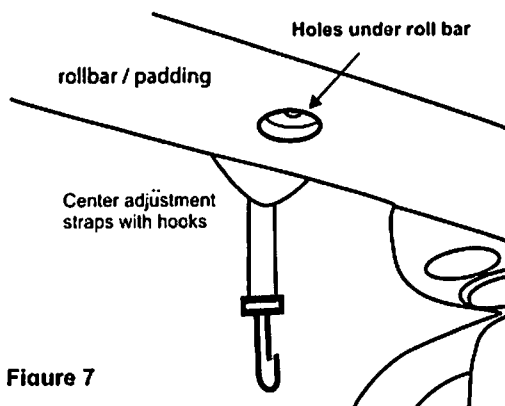

**Figure 7**

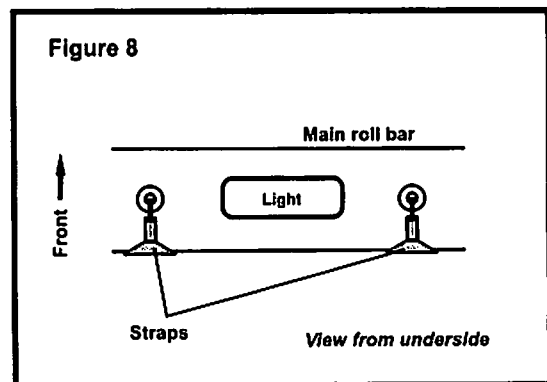

**Step 7.** Locate the ceiling adjustment straps (at rear corners on ceiling panel). Gently pull the strap over the rollbar, and around the seatbelt stud (toward the inside) and back up to the strap adjustment buckle. Tighten snug, and perform same procedure on the other side. Check top for evenness from side to side. See Figures 9, 10, 11, & 12.

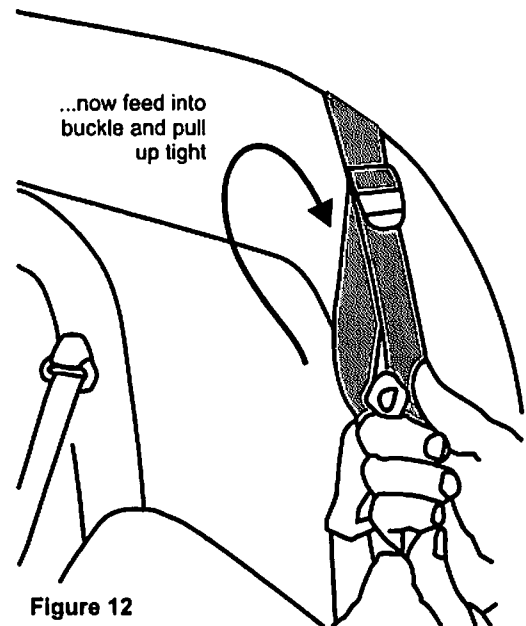
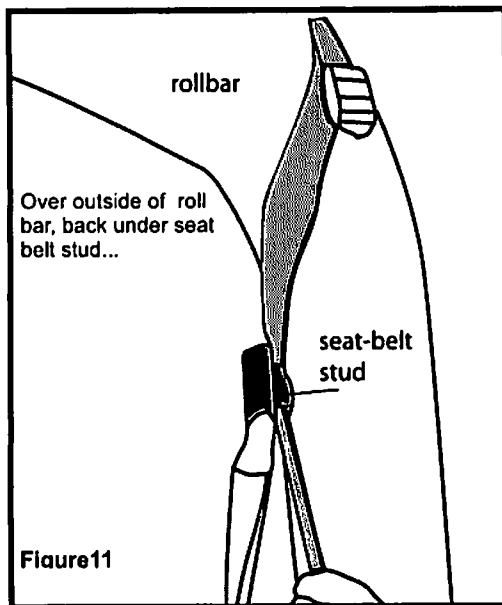
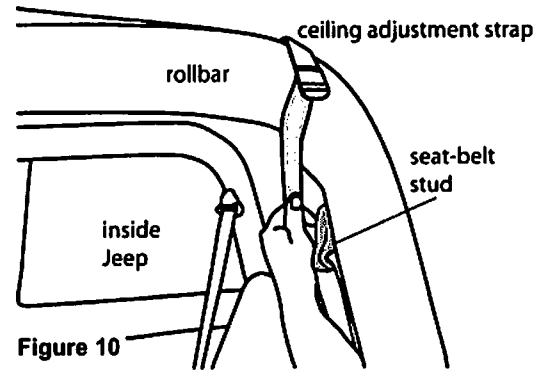
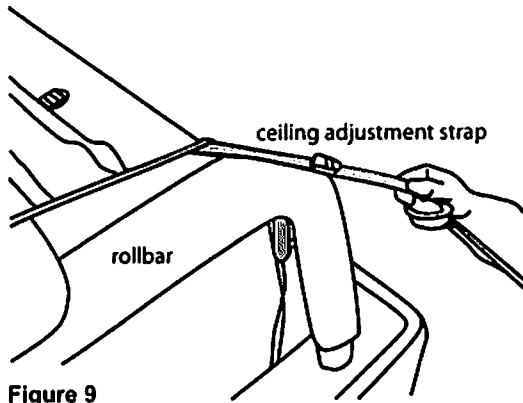

**Step 8.** Install the side windows by mating the zippers to the main skin and zip the sliders all the way along both sides. Loosely attach the rear window to the three straps on top rear. Mate the rear window zippers to the top on both sides. **NOTE: See figure 13 for detailed order instructions for installation of the zippers and channel inserts.**

**Step 9.** Continue attaching the Belt Rail plastic of the side windows from front to back, starting on the back top of the door surrounds. Hook the Belt Rail plastic to the back section of the door surround.

Figure 13

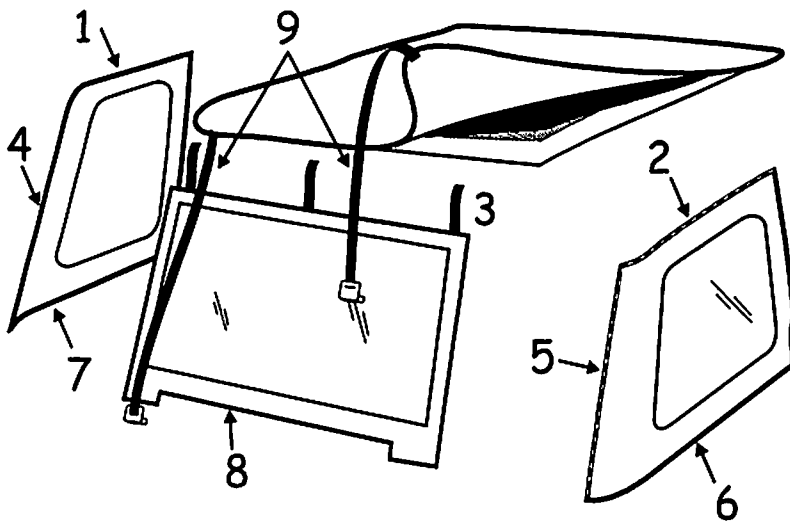

**Panel/Zipper installation order:**

- 1, 2 - Zippers to main skin
- 3 - Rear panel straps (x3) loose
- 4, 5 - Side panels to rear window
- 6, 7 - Plastic strip into body channel
- 8 - Tailgate bar
- 9 - Rear straps

- Step 10.** Prior to continuing; make sure rear panel zippers have been zipped on both sides. Set the Belt Rail plastic even with the factory weather strip at the body gutter – directly behind the door. Continue fastening the plastic under the Belt Rail lip of the body until the top is fully attached around the back corners of the body.
- Step 11.** Slide rear bar into the tube plastic on the bottom of the rear window. Insert the Tailgate Bar into the side clips, check for evenness from side to side. Rotate the bar towards the inside to lock it in place same as the factory installation. Zip the rear window and pull the Hook and Loop a.k.a. “Velcro” closed.
- Step 12.** On top of the rear part of the roll bar pull the side to side adjustment straps snug, do not over tighten. Pull the three rear window straps snug.
- Step 13.** Pull the roof top down. Handle the metal hooks on the end of the straps with care to avoid damage or injury. Attach the flat hooks under the Belt Rail at the reinforced patches on each side of tailgate, and pull the straps down snug (WITH ONE HAND). While holding the straps in-line and secured to the hook and loop, close the cam buckle into the locked position.

**The Front Bow Inserts**

The aluminum bows in the front section of the top are intended primarily to keep water from pooling on the front section of the top in heavy rains. Without the bows it is possible for water to pool in the front section of the top and cause issues with the seams because of the weight. They will also keep the top from fluttering if it is installed properly. The bows are easily removed by flexing the inner rod and removing from the pockets. The top will function normally without them, however It is recommended they be used in heavy rains when parked.

**Storing Windows**

To store your windows, begin by removing the hooks from the rear Belt Rail and flipping the top to expose the storage bag. Again, take care *not* to fling the top to avoid metal hooks causing damage or injury. Remove the windows and store them in the bag utilizing the window separation panels to protect the window.

## **Important Care Instructions:**

Convertible tops and accessories require special care if you want to get the maximum usage and enjoyment from them. The following recommendations, if followed carefully, can extend the life of your top or accessory.

Hand wash using a mild non-detergent soap such as ivory. Use a non-abrasive cloth or sponge. Rinse thoroughly.

Do not wash in direct sunlight and avoid automatic car washes

When your top is clean, we recommend using "Ragg Topp" or "303 Protectant" on both the vinyl top and windows.

This product contains a sunscreen that helps protect from the sun's damaging rays. Stay away from products containing alcohol, as it will cause the fabric and windows to lose their elasticity, thus reducing the life of your top or accessory. If you are unable to locate "RaggTopp" Please call 1-800-377-4700 for a distributor near you. For "303 Protectant", please call 1-800-223-4303 for a distributor near you.

Direct sunlight and heat are the biggest enemies of the windows. Park in the shade whenever possible. If you must park in the sunlight, rotate the direction that you park every few days so all windows get even exposure.

Our tops are designed so that you may roll up and/or store the rear curtain and side curtains. To prevent scratching of the windows, be sure that windows are completely clean and free of dust particles. Even a little dirt will badly scratch the windows. You may want to use a soft cloth when rolling up or storing your windows. Heat may build up on rolled up windows, so be sure to unroll them frequently. If you roll up the windows at the beginning of summer and leave them, they may be ruined by fall.

Do not open or roll up windows at temperatures below 45 degrees F this could cause them to crack or break.

### **Zipper Care.**

DO NOT use pliers or other tools to pull on zippers. If the zipper requires more force than pulling with your fingers something is most likely out of alignment or improperly installed. Be sure the top is up to a temperature of 70 deg., and that the components are installed correctly and in the correct sequence to ensure protection of the zipper.

Zippers require periodic cleaning and lubrication to ensure longevity and ease of use. Clean by wiping with a towel soaked in soap and water, DO NOT USE HARSH CHEMICALS. Zipper lubricants are available at sporting goods stores and online for wetsuits. An occasional use will keep the zipper slides operating as new.

## **Warranty Information**

Rampage products, Inc. warrants to the original purchaser of any top it manufactures, that the top will be free of defects in material or workmanship for a period of 2 year from date of purchase. Such obligations under this warranty shall be limited to the repair or replacement, at Rampage products discretion, of any assembly or parts which, upon examination by Rampage products, Inc. proves to be defective. All defective items must be returned with proof of purchase to Rampage products, Inc., freight prepaid. This warranty does not cover damage resulting from abuse, misuse, alteration, accident or damage in transit. Rampage products obligations under this warranty are limited to the aforementioned repair or replacement of warranty defects for which the return authorization has been received during the warranty period, and Rampage products, Inc. shall not be liable for any incidental or consequential damages arising from breach of this or any implied warranty.

**Rampage Products Inc., Corona, CA 92883 Phone: (951) 277-4949 Fax: (951) 277-2295**

**[www.rampageproducts.com](http://www.rampageproducts.com)**

*Made in China*



**1**

### Overview of installation

This top relies on a very snug fit to make it function correctly and can be difficult to install the first time if instructions are not followed. Use this sheet as an overview but **PLEASE** read and understand **all instructions** before beginning. The order of installation described here is intended for the first time install and varies slightly from the main instruction. Once the top temp cycles for a few days the standard method described in the main instruction will work fine.

**IMPORTANT:** The top needs to be warm before installing the first time to aid in stretching the material. If cold, it may appear too tight. **DO NOT** force zippers if the top is too tight as they may break. Instead, zip all the rear section panels together before inserting the plastic into the body/door surround channels and attaching tailgate bar.

**2**

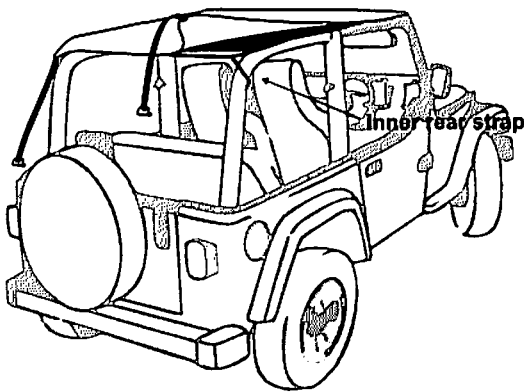

Install main panel on vehicle including inner rear straps, header and inside windshield strap

**3**

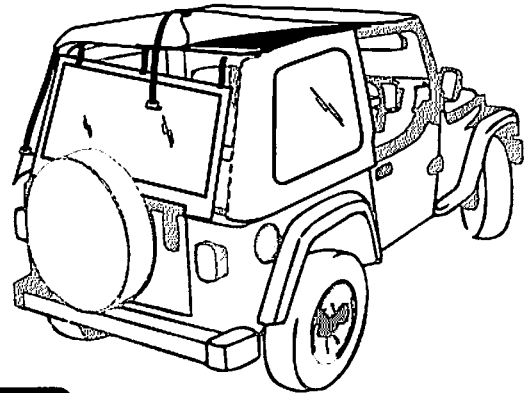

Zip all panels together and loosely strap the top of the rear window.  
(Do not insert any of the plastic in channels yet.)

**4**

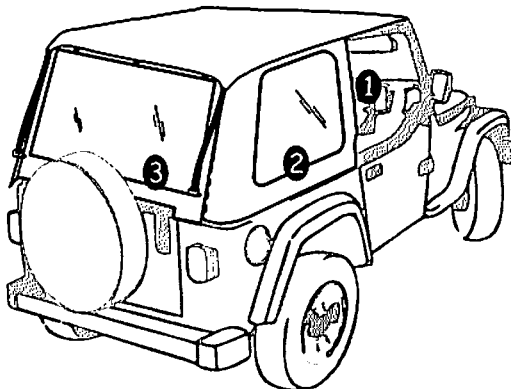

Now insert the door surround plastic channels (1), then the belt rail channels (2), and finally the tailgate bar and rear flaps (3).

**5**

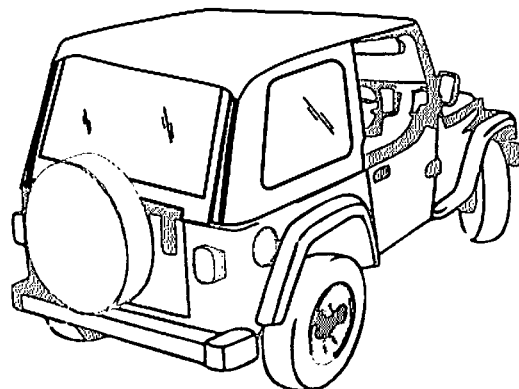

Finish with the rear straps and adjusting the velcro on the side sections and rear window.

### Panel/Zipper installation order:

- 1 - Zippers to main skin
- 2 - Rear panel straps (x3) loose
- 3 - Side panels to rear window
- 4 - Plastic strip into body channels
- 5 - Tailgate bar
- 6 - Rear straps

**If you have questions or issues with this installation please call Rampage Products Technical support at 951-277-4949 and we will be happy to assist you.**