



www.hylineoffroad.com

1507 C West Park Avenue ~ Perkasio, PA 18944
 Tel: 1.888.495.4631 ~ Fax: 215.257.4364

Proudly Made In USA

Installation Instructions:

JK Standard & Crawler Front Bumper
 Part Number(s): **400.100.110 & 400.110.120**

Vehicle Fitment:

2007 - Present Jeep Wrangler
 & Unlimited

Parts List

Qty:

- 1 Standard Front Bumper
- 1 Winch Plate
- 2 Left & Right Bumper Mounting Brackets
- 1 2012 & Newer Bracket
- 8 8-32 Lock Nuts
- 8 8-32 Flat Washers
- 6 7/16-20 Grade 8 Bolts
- 14 7/16" Lock Washers
- 18 7/16" Flat Washers
- 12 7/16-20 Grade 8 Nuts
- 2 7/16-20 Weldnut Tabs

Tools Needed

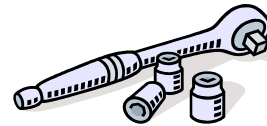

Ratchet
 18mm Deep Socket
 6" Extention
 11/16" Deep Socket
 5/8" Socket
 11/32" Deep Socket
 Torque Wrench



5/8" Wrench

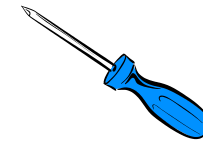

Phillips Screwdriver

Congratulations on your purchase of the Hyline Offroad Standard Front Bumper. Our Bumpers are completely manufactured in our facility located in Perkasio, PA. They are designed and engineered by Offroad enthusiasts just like you to be rock solid at an affordable price. Hyline Offroad would like to thank you for your recent purchase and look forward to serving you in the future.

Hyline Offroad Staff

PLEASE READ INSTRUCTIONS BEFORE BEGINNING INSTALLATION

Front Bumper Installation

Step 1 – Remove plastic factory frame rail cover by unscrewing two plastic screws. Be careful while unscrewing these. The plastic is very weak and is easy to strip out. You will *NOT* be reusing this cover. Also remove the factory plastic air dam, which is located underneath the bumper.

Step 2 – If your vehicle is equipped with factory fog lights you will need to unplug them. Pull out or cut the plastic wire ties that are holding the wires in place (3 Wire Ties) **DO NOT CUT WIRES**. Then, slide stock bumper out far enough to unplug the fog lights.

Step 3 – Remove Stock bumper by unbolting the eight (8) 18mm nuts From backside of bumper. Nuts are located on the inside and outside of frame rails (See Figure 1 - Outside frame rails shown) Say goodbye to that flimsy plastic stock bumper.

Step 4 – If applicable, Unscrew Factory Fog Lights at this point using phillips screw driver. (4 on each light)

Step 5 – Install factory fog lights into Hyline Front Bumper. Make sure the adjustment screw is facing toward the bottom of the bumper. There is a hole in the bumper to allow adjustment after Installation. Assemble fog lights using supplied 8-32 Lock Nuts and Flat Washers. Tighten the nuts with 11/32” Deep Socket or Nut Driver. (See Figure 2)

If Applicable

Disconnect all Aftermarket External Lighting Wiring that is presently attached to existing bumper.

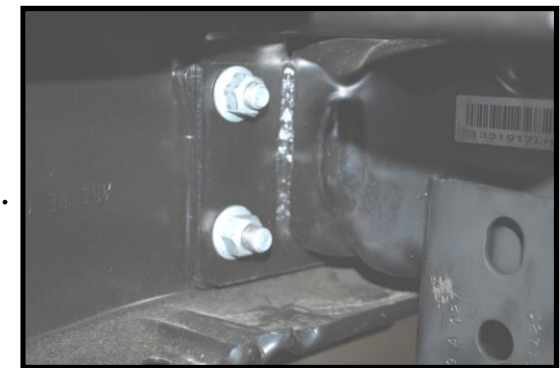

Figure 1

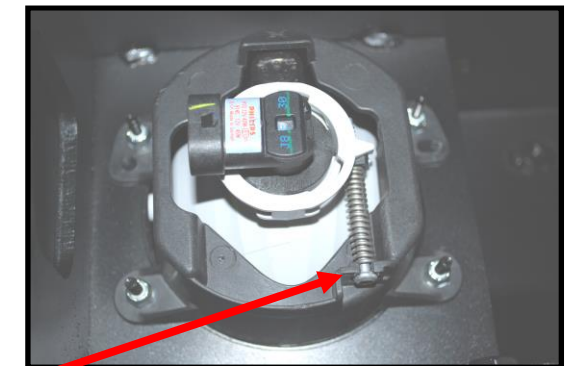

Figure 2

Adjustment Screw

Step 6 – Install Hyline Front Bumper onto vehicle. Two people are recommended for this step. Use supplied 7/16-20 Grade 8 Nuts, Lock Washers and Flat Washers to assemble bumper to frame. (See Figure 3) After all eight nuts are hand threaded you may tighten all nuts to 78 ft/lb torque.

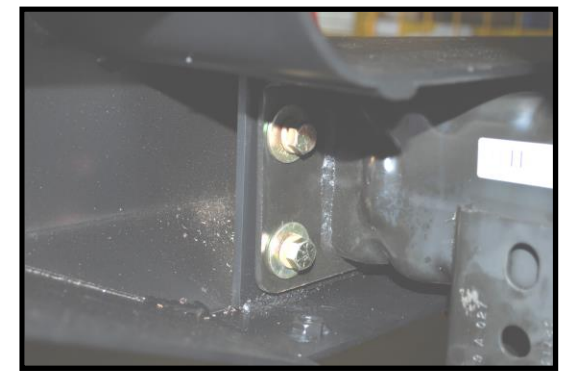

Figure 3

Step 7 – Install Mounting Brackets using supplied 7/16-20 Grade 8 Bolts Lock Washers, Flat Washers, & Nuts. (See Figure 4, 5 & Supplement Diagram 1 on Page 5) These figures are shown with the bumper off the vehicle, however you should have the bumper installed on vehicle prior to assembling brackets. 2012 and newer Jeep models will require you to use the unique bracket with weldnuts on the driver side only in place of the other bracket. Use the 5/8” Wrench on the bolt head and the 11/16” Deep Socket to tighten the nut. It’s going to be a little tight, but is easy once you’re positioned correctly.

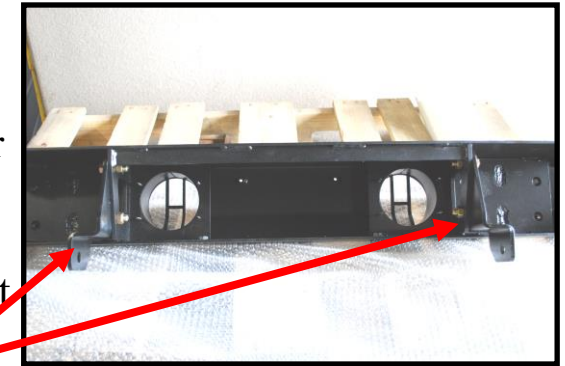
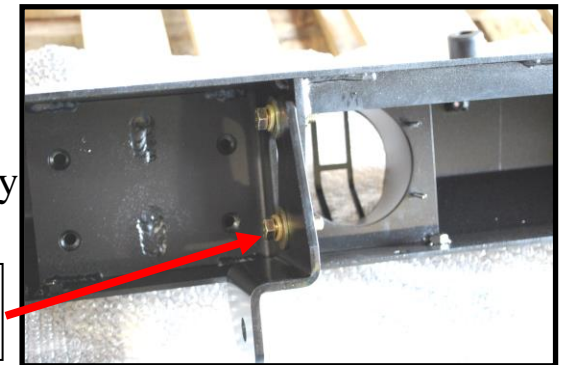

Figure 4

Left & Right Mounting Brackets

Step 8 – Install the last two 7/16-20 Grade 8 bolts on each brackets with Lock Washers & Flat Washers and the Weldnut Tabs. Weldnut Tabs are placed up inside the square tube that is attached vertically to the vehicles’ frame. (See Figure 5)



7/16-20 Bolt is inserted through opposite side of this hole.

Figure 5

Step 9 – Plug in factory fog lights again. Tighten all 7/16-20 Bolts to 78 ft/lb torque and recheck other bolts for tightness.

Optional Winch Installation

- Step 1 – Bolt on Fairlead supplied with winch, to the Winch Plate supplied with Bumper. Tighten Bolts.
Step 2 – Mount Winch and Winch Plate onto Bumper using supplied hardware with winch.
Step 3 – Tighten all Winch Bolts to manufacturers torque specifications.

SUPPLEMENT DIAGRAM 1

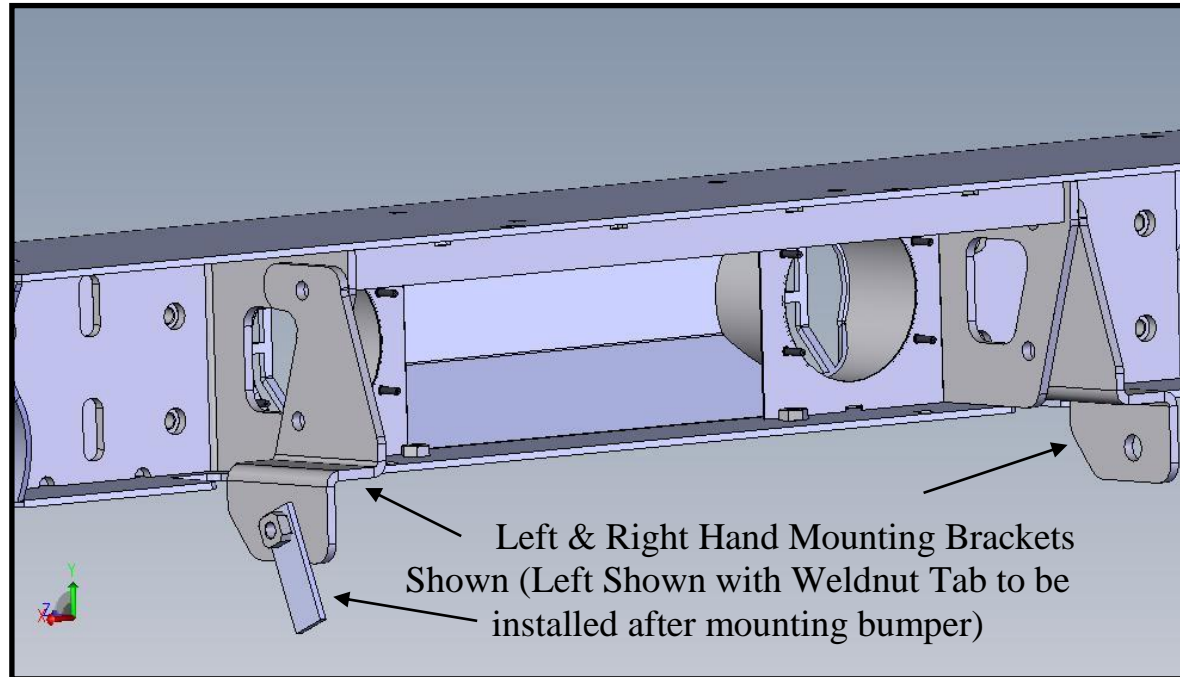

! Attention

Installation instructions provided must be read and followed exactly when installing product. Failure to do so could potentially result in injury or death of any occupants in the vehicle. **WEAR SEAT BELTS AT ALL TIMES WHEN DRIVING!**

Though our products are rugged, they are primarily designed and built to enhance the appearance of the vehicle and will not protect from death or injury in the event of an accident. Adhere to all vehicle manufacturers specifications.

Now you're ready for the ROCKS!!

Send your OFFROAD pictures to pics@HylineOffroad.com . If we choose any one of your pictures to be used on our website, We send you a FREE Hyline Offroad T-Shirt.