



Lower Cargo Rack Bracket Installation Instructions

For: Wrangler, 1992 - 2002

Part Number: 41406



	WARNING
<p>This product is designed to enhance the appearance of the vehicle. Do not rely in any way on the components of this product to contain occupants within the vehicle, or to protect against injury or death in the event of an accident. Never operate vehicle in excess of manufacturer's specifications.</p>	
WEAR SEAT BELTS AT ALL TIMES	
<p>Read and follow, precisely, all installation instructions provided when installing this product. Failure to do so could place occupants of the vehicle in a potentially dangerous situation. After installing or reinstalling, check to make sure it has been properly installed.</p>	

Table of Contents	
LOWER CARGO RACK BRACKET PARTS LIST	PAGE 2
LOWER CARGO RACK BRACKET HARDWARE IDENTIFICATION ...	PAGE 2
LOWER CARGO RACK BRACKET TOOLS NEEDED	PAGE 2
LOWER CARGO RACK BRACKET INSTALLATION	PAGE 2
LOWER CARGO RACK BRACKET WARRANTY	PAGE 4

Parts List and Hardware Identification

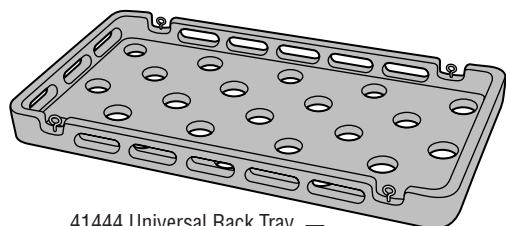

41444 Universal Rack Tray
(Sold Separately), Qty - 1

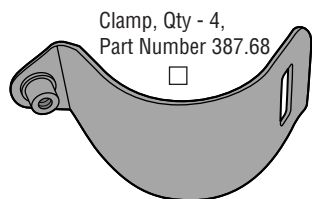

Clamp, Qty - 4,
Part Number 387.68

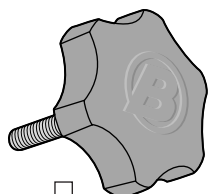

Knob, Qty - 4,
Part Number 374.54

Front Load Bar, Qty - 1,
Part Number 387.70

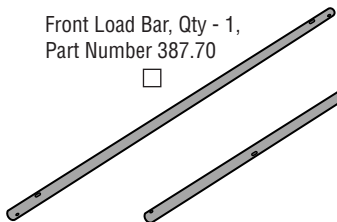

Rear Load Bar, Qty - 1,
Part Number 387.71

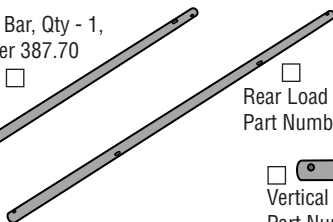

Vertical Bar, Qty - 2,
Part Number 387.72

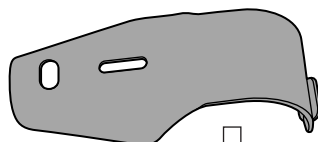

Vertical Mount Bracket, Qty - 2,
Part Number 387.66

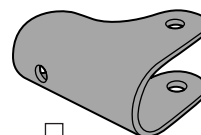

Pivot Bracket, Qty - 2,
Part Number 387.69

Horizontal Mount Bracket,
Qty - 2, Part Number 387.67

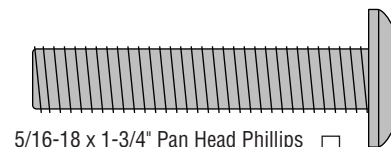
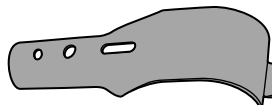

5/16-18 x 1-3/4" Pan Head Phillips
Screw, Qty - 8, Part Number 387.91

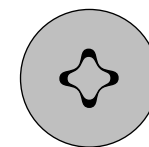

1/4-20 x 1-1/2" Hex Head Bolt,
Qty - 4, Part Number 387.90

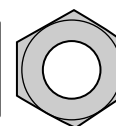
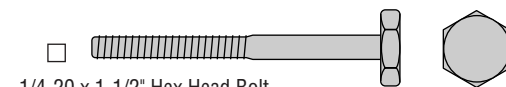

5/16-18 Lock Nut, Qty - 8,
Part Number 378.53



1/4" Lock Washer, Qty - 4,
Part Number 378.55

Tools Needed

#2 Phillips Screwdriver
7/16" Wrench
1/2" Wrench

Installation

Step One

INSTALL HORIZONTAL MOUNT BRACKETS ON REAR LOAD BAR

The Rear Load Bar is the one that has the slots located closest together. Place the Horizontal Mount Brackets on each end of the Rear Load Bar. Use the hole nearest the end of the bracket if you are installing on a 1992 - 1995 Wrangler. Use the second mounting hole if you are installing on a 1997 - 2002 Wrangler. Use a 5/16-18 x 1-3/4" Pan Head Screw and a 5/16-18 Lock Nut for each Horizontal Mount Bracket.

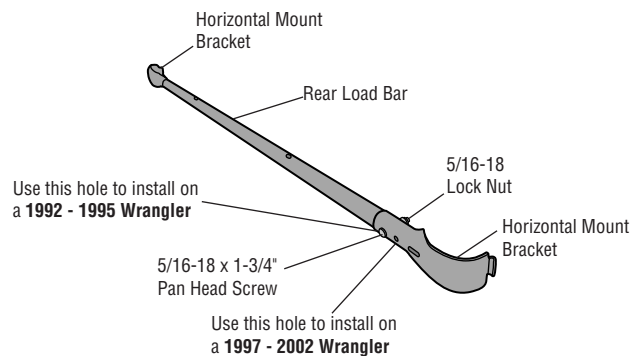

Step Two

INSTALL PIVOT BRACKET AND VERTICAL MOUNT BRACKET ON VERTICAL BAR

Place a Pivot Bracket on one end of each Vertical Bar. Install a 5/16-18 x 1-2/3" Pan Head Screw and 5/16-18 Lock Nut and tighten securely. Then place a Vertical Mount Bracket on the other end of each Vertical Bar. Loosely install a 5/16-18 x 1-3/4" Pan Head Screw and 5/16-18 Lock Nut in each bracket.

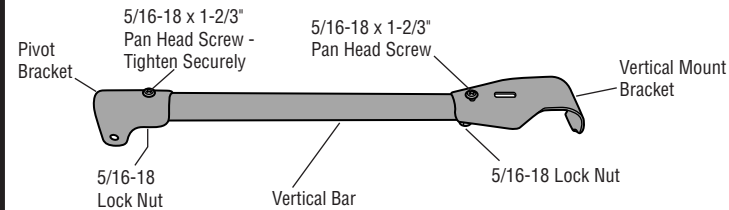

Caution

DO NOT overtighten the bolts that attach the Pillars to the Tray. This may strip the aluminum inserts in the Tray.

Step Three

INSTALL REAR LOAD BAR ON TRAY ASSEMBLY

Orient the Rear Load Bar Assembly on the bottom of the Tray over the attachment points next to the long side of the tray. The Horizontal Mount Brackets should angle away from the Tray. If they do not, flip the bar end over end. Secure the Load Bar with two 1/4-20 x 1-1/2" Hex Bolts and two 1/4" Lock Washers.

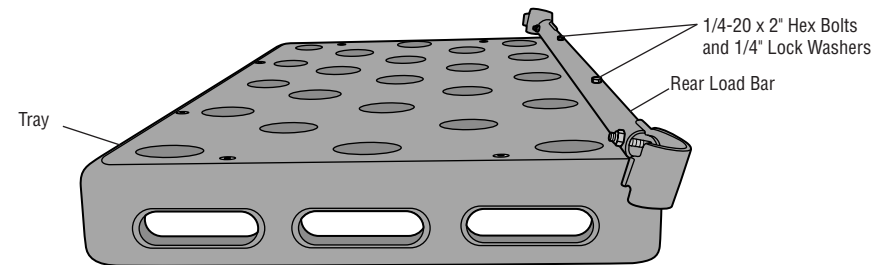

Note: Hold the Lock Washers while tightening the bolts so that they don't fall into the slot.



Caution

DO NOT overtighten the bolts that attach the Pillars to the Tray. This may strip the aluminum inserts in the Tray.

Step Four

INSTALL FRONT LOAD BAR ON TRAY ASSEMBLY

Orient the Front Load Bar Assembly on the bottom of the Tray over the attachment points next to the short side of the tray. Secure the Load Bar with two 1/4-20 x 1-1/2" Hex Bolts and two 1/4" Lock Washers.

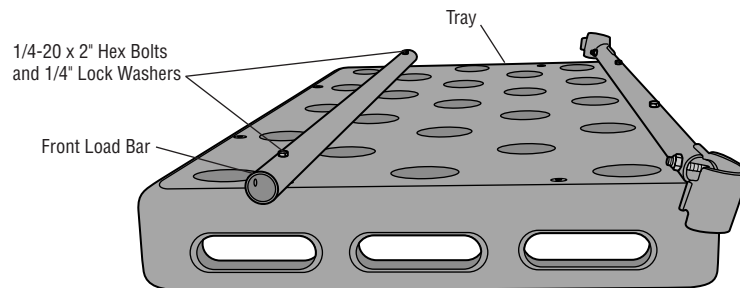

Note: Hold the Lock Washers while tightening the bolts so that they don't fall into the slot.

Step Five

INSTALL VERTICAL BAR ASSEMBLIES

Loosely attach the Pivot Brackets on the Vertical Bar Assemblies to the ends of the Front Loader Bar. Use a 5/16-18 x 1-3/4" Pan Head Screw and a 5/16-18 Lock Nut for each Vertical Bar Assembly.

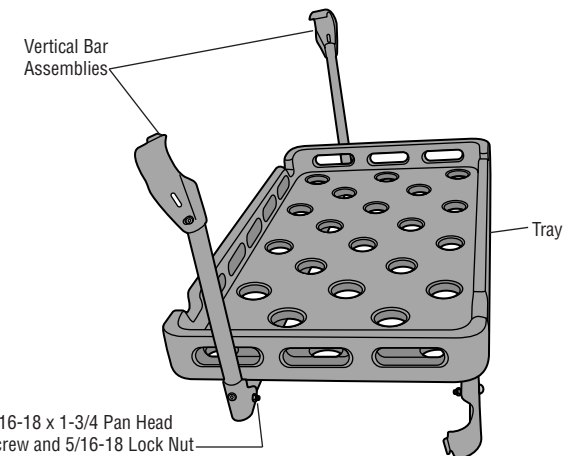

Step Six

INSTALL TRAY ASSEMBLY

Hook the Vertical Mount Brackets around the horizontal part of the sport bar and hook the Horizontal Mount Brackets around the back of the vertical sport bar leg so that the Tray is level.

Use a Knob and Clamp to secure each bracket to the sport bar. Place the slot in the Clamp over the hook on each Mount Bracket and wrap the Clamp around the sport bar. Insert the shaft of a Knob into the slot the Mount Bracket and push the Clamp toward the Knob. Thread the Knob into the Clamp and tighten. Repeat this for each Mount Bracket.

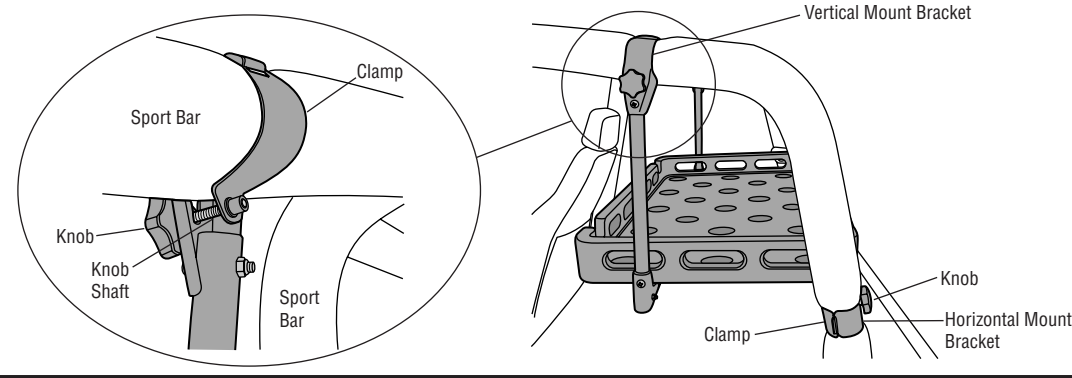

Step Seven

Tighten Fasteners

Fully tighten the screws that attach the Pivot Brackets and Vertical Mount Brackets to the Horizontal Bar. Make sure that the Knobs and fasteners are tight before using the Tray.



Caution

DO NOT load the Tray with more than 200 evenly distributed pounds.

LIMITED WARRANTY

We warrant our product to be free from defects in material and workmanship, for terms specified below, provided there has been normal use and proper maintenance. This warranty applies to the original purchaser only. All remedies under this warranty are limited to the repair or replacement of any item or items found by the factory to be defective within the time period specified.

If you have a warranty claim, first you must call our factory at the number below for instructions. You must retain proof of purchase and submit a copy with any items returned for warranty work. Upon completion of warranty work, if any, we will return the repaired or replaced item or items to you freight prepaid. Damage to our products caused by accidents, fire, vandalism, negligence, misinstallation, misuse, Acts of God, or by defective parts not manufactured by us, is not covered under this warranty.

THE WARRANTY TIME PERIOD IS AS FOLLOWS: ALL "GOODS" MANUFACTURED BY OUR COMPANY: ONE YEAR FROM DATE OF PURCHASE.

ANY IMPLIED WARRANTIES OF MERCHANTABILITY AND/OR FITNESS FOR A PARTICULAR PURPOSE CREATED HEREBY ARE LIMITED IN DURATION TO THE SAME DURATION AND SCOPE AS THE EXPRESS WRITTEN WARRANTY. OUR COMPANY SHALL NOT BE LIABLE FOR ANY INCIDENTAL OR CONSEQUENTIAL DAMAGE.

Some states do not allow limitations on how long an implied warranty lasts, or the exclusion or limitation of incidental or consequential damages, so the above limitations or exclusions may not apply to you.

This warranty gives you specific legal rights, and you may also have other rights which vary from state to state.

For further information, please contact:

Bestop Inc.
Customer Service
(800)845-3567
(303)465-1755