

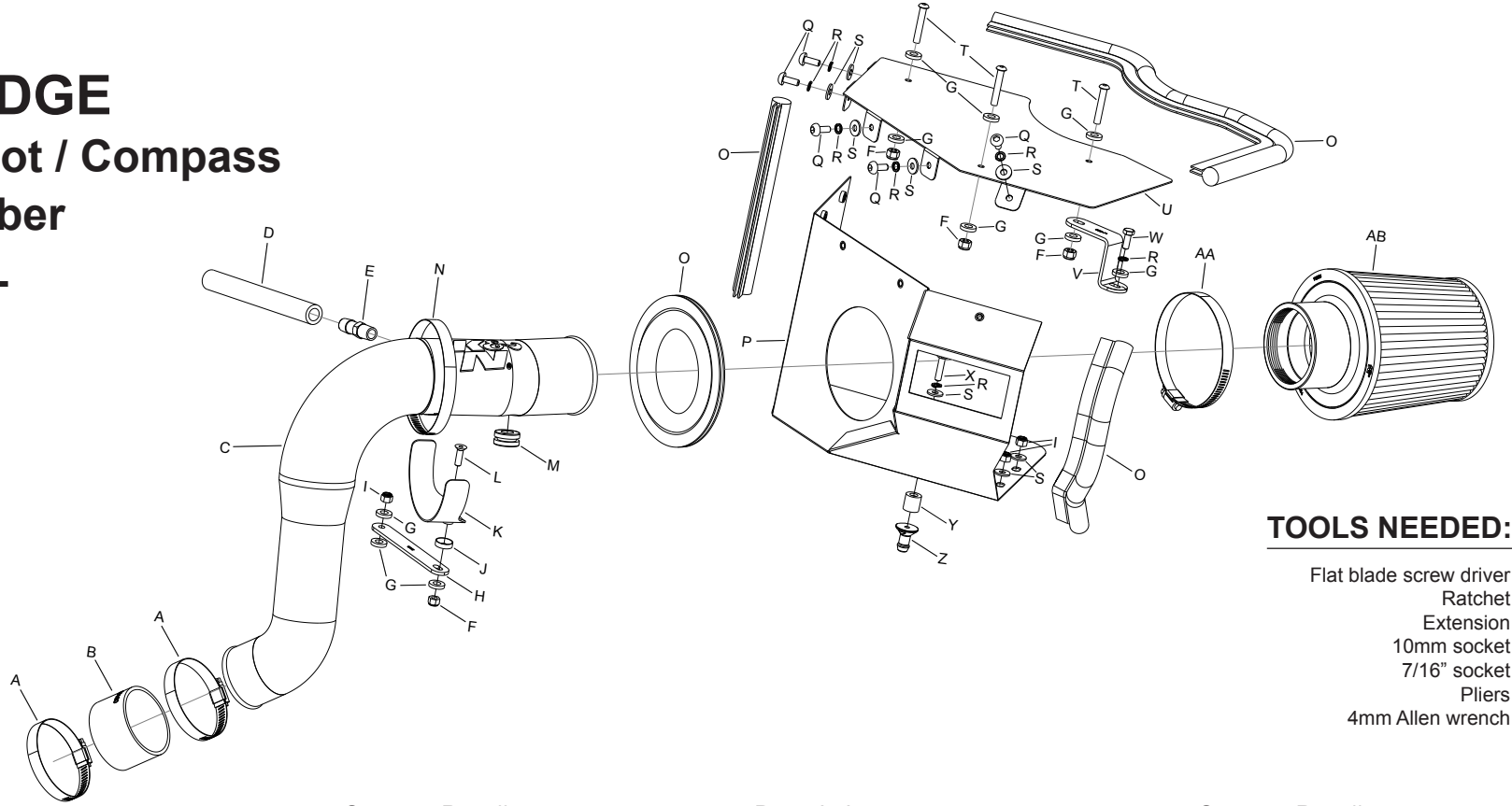

INTAKE SYSTEMS FOR VEHICLES LISTED ARE 50 STATE LEGAL. SEE KNFILTERS.COM FOR CARB STATUS ON EACH PART FOR A SPECIFIC VEHICLE.

INSTALLATION INSTRUCTIONS

57-1567
JEEP / DODGE
2011-14 Patriot / Compass
2011-12 Caliber
L4-2.0L / 2.4L



TOOLS NEEDED:

- Flat blade screw driver
- Ratchet
- Extension
- 10mm socket
- 7/16" socket
- Pliers
- 4mm Allen wrench

PARTS LIST:

Description	Qty.	Part #	Description	Qty.	Part #
A Hose Clamp #40	2	08554	O Edge Trim (55")	1	102480
B Hose; 2-5/8"ID X 1-3/4"L Reinforced	1	08108	P Heat Shield	1	07398
C Intake Tube (GG)	1	087206	Q Bolt; M6 X 1.00 X 16MM, Buttonhead, SS	5	07730
D Hose; 1/2"ID X 7"L	1	08159	R Washer; M6 Split Lock Zinc	7	1-3025
E Vent; STRT 1/2" Hose, 1/4"NPT, Plas	1	080022	S Washer; 6MM Flat, SS	8	08269
F Nut; 6MM Nylock, Hexhead, SS	4	07512	T Bolt; 1/4-20 X 1-1/2"L, Buttonhead, SS	3	22216
G Washer; 1/4"ID X 5/8"OD-SAE	10	08275	U Lid	1	07397
H Bracket; 57-1552, Mild STL, TB/PC	1	26636	V Bracket; "Z", 63-1567, STL, TB/PC	1	083171
I Nut; 1/4-20, Nylock, SS	3	07519	W Bolt; 6MM-1.00 X 16MM, SS	1	07812
J Washer; Conical, Nylon, Black	1	08180	X Bolt; M6-1.00 X 25MM, SS	1	07858
K Bracket; 59-4540, Saddle, S/S	1	078855	Y Threaded Boss; 5/8"OD X 5/8"L, M6-1.00	1	081003
L Bolt; 6MM-1.00 X 20MM F/H/A, SS	1	08376	Z Mount; Plastic Airbox	1	8-186-1
M Grommet; 1"OD, 1/2"ID, 1/2"THK	1	08064	AA Hose Clamp #52	1	08610
N Hose Clamp #44 Stainless	1	08560	AB Air Filter	1	RU-4990

NOTE: FAILURE TO FOLLOW INSTALLATION INSTRUCTIONS AND NOT USING THE PROVIDED HARDWARE MAY DAMAGE THE INTAKE TUBE, THROTTLE BODY AND ENGINE.

TO START:

1. Turn off the ignition and disconnect the negative battery cable.
NOTE: Disconnecting the negative battery cable erases pre-programmed electronic memories. Write down all memory settings before disconnecting the negative battery cable. Some radios will require an anti-theft code to be entered after the battery is reconnected. The anti-theft code is typically supplied with your owner's manual. In the event your vehicles' anti-theft code cannot be recovered, contact an authorized dealership to obtain your vehicles anti-theft code.

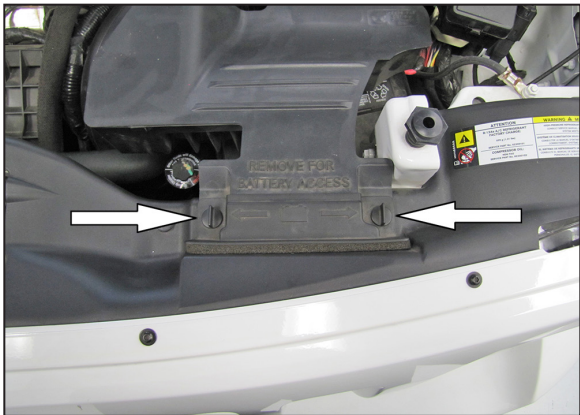

2. Release the two locks securing the fresh air intake scoop and then remove the fresh air intake scoop from the vehicle.

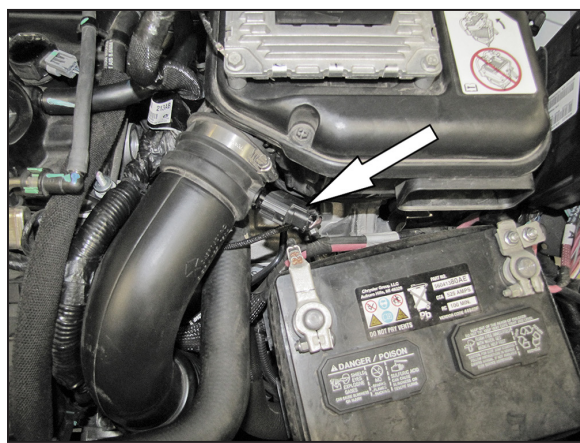

3. Disconnect the inlet air temperature sensor electrical connection.

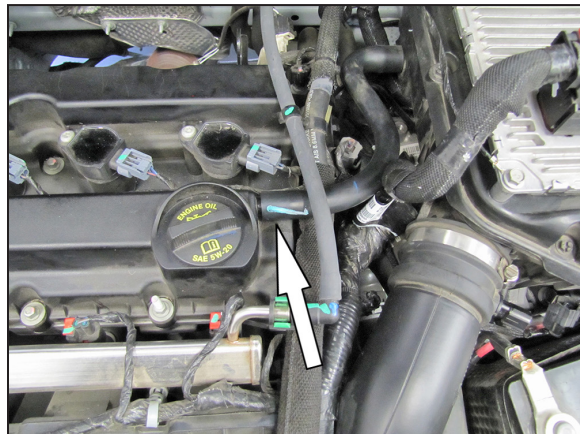

4. Disconnect the crank case vent hose from the valve cover.



5. Remove the three bolts securing the ECU and ECU ground to the air box lid and then flip the ECU over and lay it on the valve cover.
NOTE: It is NOT necessary to disconnect the ECU electrical connection.



6. Loosen the hose clamp which secures the intake tube to the air box and then disconnect the intake hose from the air box.

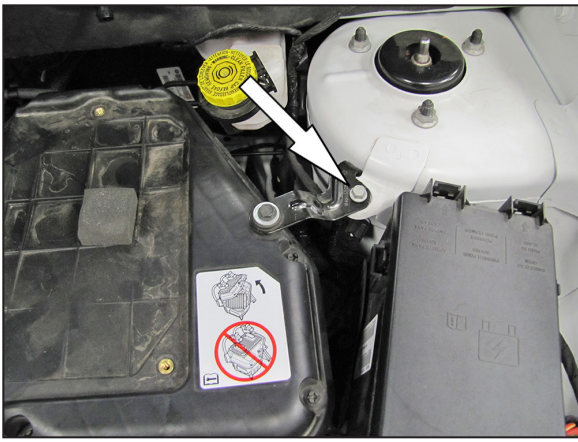

7. Remove the bolt securing the air box mounting bracket to the inner fender.



8. Lift up the air box to dislodge it from the mounting grommets and then remove it from the vehicle.

NOTE: K&N Engineering, Inc., recommends that customers do not discard factory air intake.

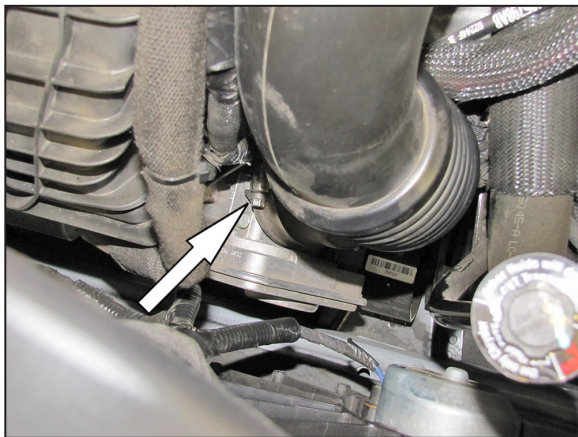

9. Loosen the hose clamp securing the stock intake tube to the throttle body and then remove the intake tube from the vehicle.

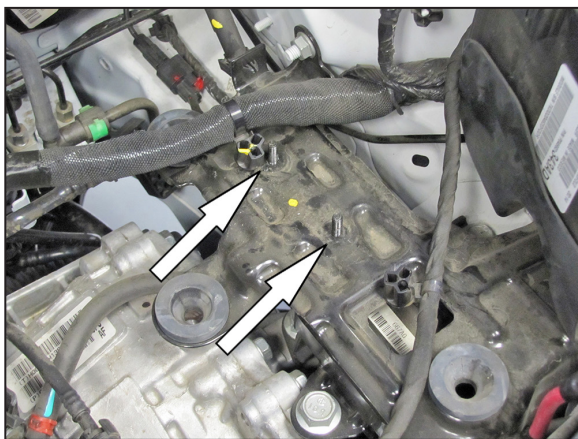

10. Unhook the wiring harness from the mounting studs.

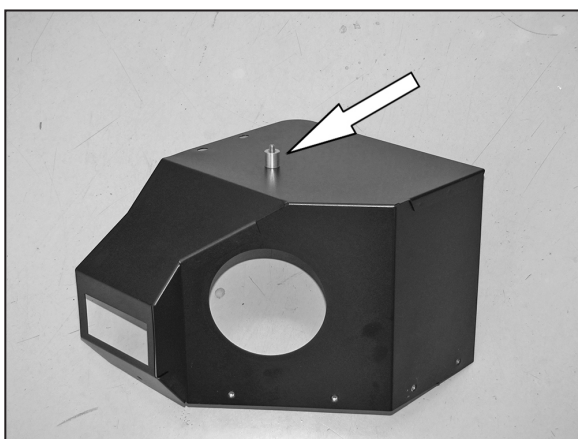

11. Install the heat shield mounting stud spacer onto the heat shield as shown using the provided hardware.

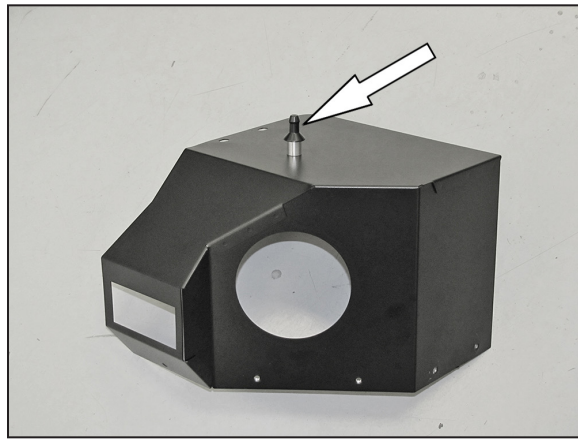

12. Install the heat shield mounting stud onto the spacer as shown.

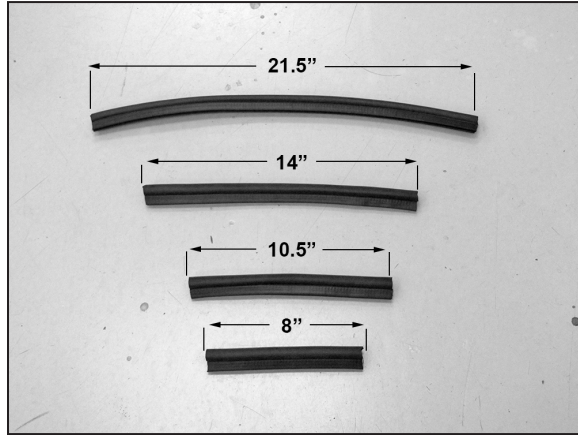

13. Cut the provided edge trim into four sections, one will be 8" long, one 10.5" long, one 14" long and one will be 21.5" long.

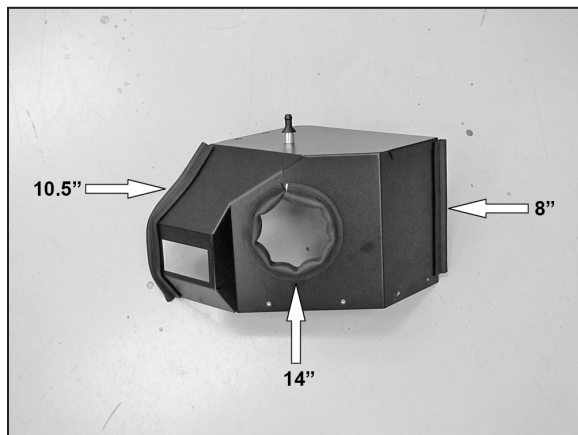

14. Install the 8", 10.5" and 14" long edge trim onto the heat shield as shown.

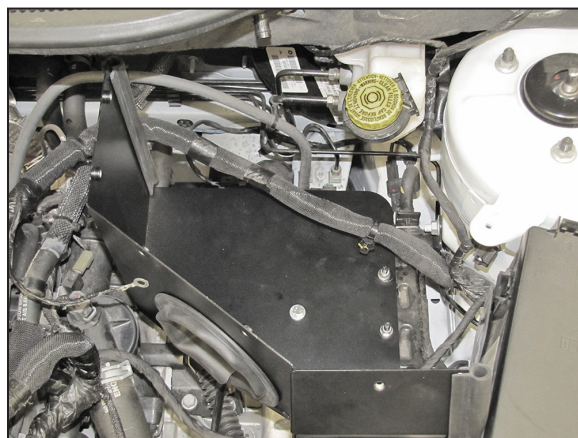

15. Install the heat shield onto the air box mounting plate so that the mounting stud installs into the grommet and the threaded studs protrude through the heat shield. Secure the heat shield with the provided hardware.

NOTE: be sure that the two wiring harness are not pinched between the heat shield and mounting bracket. Due to manufacturer tolerances, it may be necessary to adjust the mounting bracket back to allow for heat shield clearance.

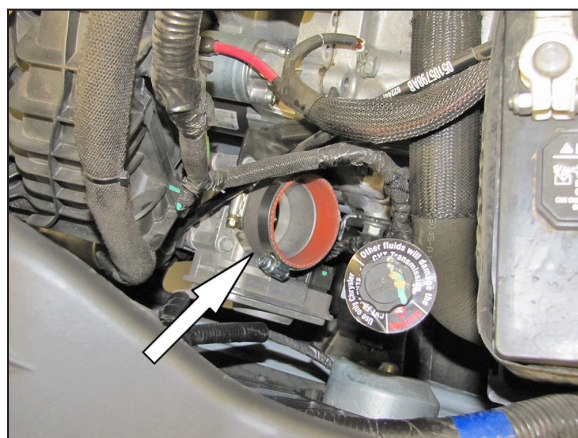

16. Install the provided silicone hose (08108) onto the throttle body and secure with the provided hose clamp.



17. Install the saddle clamp onto the tube mounting bracket as shown using the provided hardware.

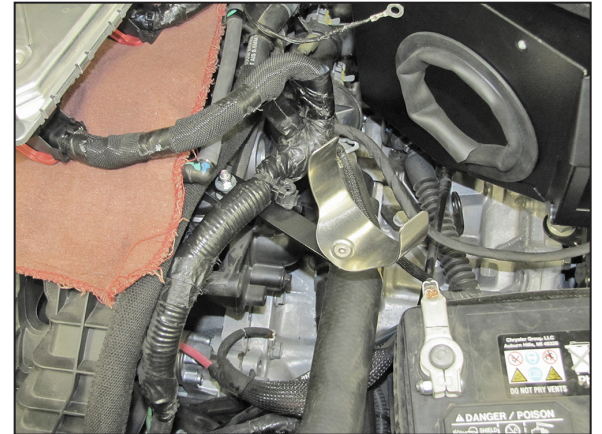

18. Unhook the wiring harness from the valve cover mounting stud, install the provided flat washer onto the stud and then install the tube mounting bracket assembly and secure with the provided washer and locking nut.



19. Install the provided vent fitting into the K&N® intake tube as shown.

NOTE: Plastic NPT fittings are easy to cross thread. Install the vent fitting "hand" tight, then turn it two complete turns with a wrench.



20. Install the provided grommet into the K&N® intake tube as shown.



21. Remove the inlet air temperature sensor from the factory intake tube.

NOTE: The inlet air temperature sensor is very fragile, use care while removing sensor.

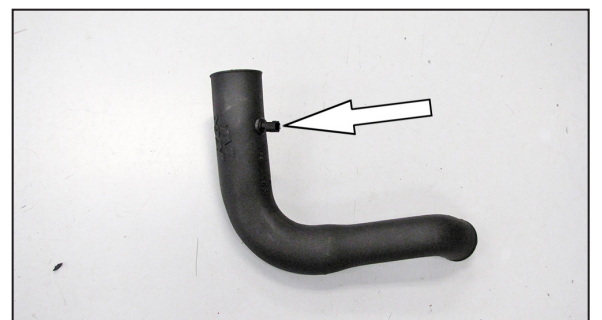

22. Install the inlet air temperature sensor into the grommet installed into the K&N® intake tube.
NOTE: The inlet air temperature sensor is very fragile, use care while installing sensor.



23. Install the K&N® intake tube into the silicone hose at the throttle body and then secure the intake tube with the provided hose clamps.

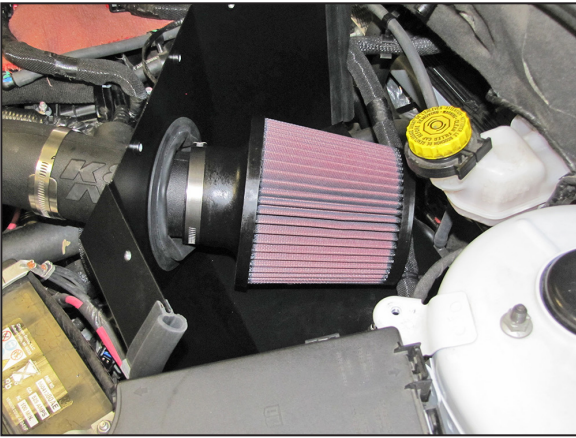

24. Install the K&N® air filter and secure with the provided hose clamp.
NOTE: Drycharger® air filter wrap; part # RU-4990DK is available to purchase separately. To learn more about Drycharger® filter wraps or look up color availability please visit <http://www.knfilters.com>.

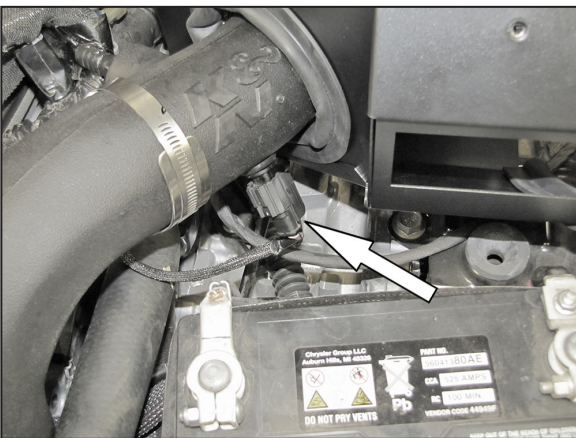

25. Reconnect the inlet air temperature sensor electrical connection.

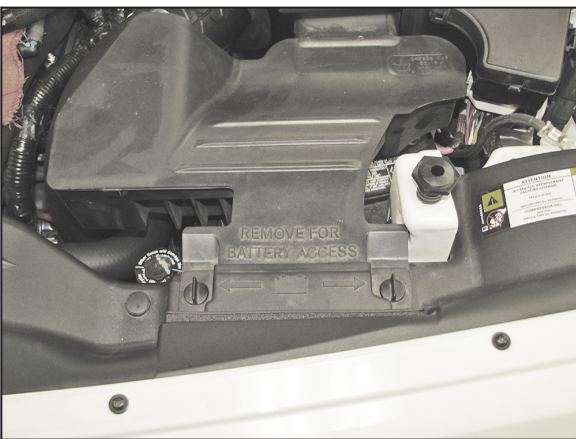

26. Install the fresh air intake scoop into the heat shield and then secure it to the core support with the factory clips.

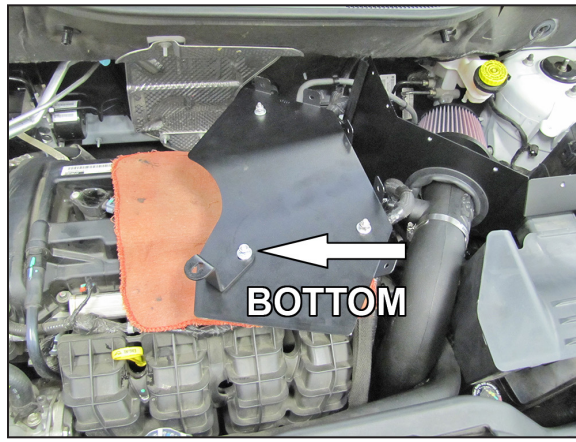

←
BOTTOM

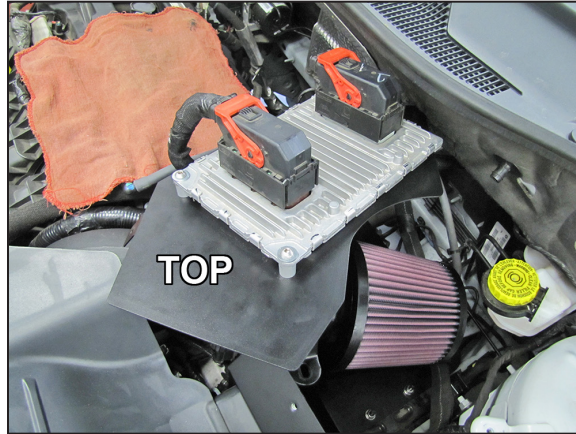

TOP

27. Secure the ECU and mounting bracket (083171) and ground strap to the air box lid using the provided hardware as shown.



28. Install the 22" long edge trim onto the air box lid as shown.



29. Secure the heat shield lid to the heat shield and factory air box mount using the provided hardware.
NOTE: Be sure to make sure that the wiring harnesses are not bound tight and are routed freely to prevent any possible damage. It may be necessary to adjust the wiring harness attaching points to loosen them up.

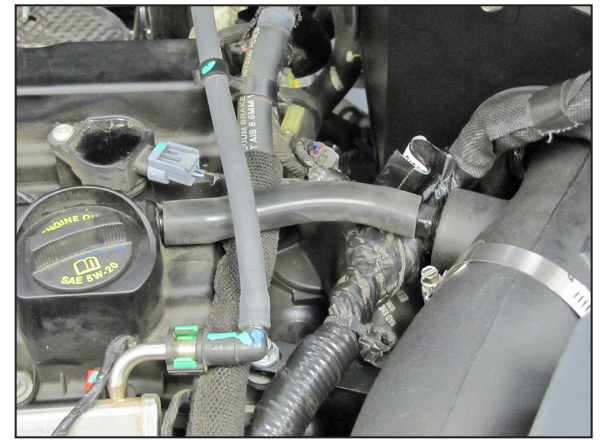

30. Install the provided crank case vent hose onto the valve cover port and then connect the open end to the fitting installed into the intake tube as shown. Trim and adjust as necessary to prevent collapsing of the hose.

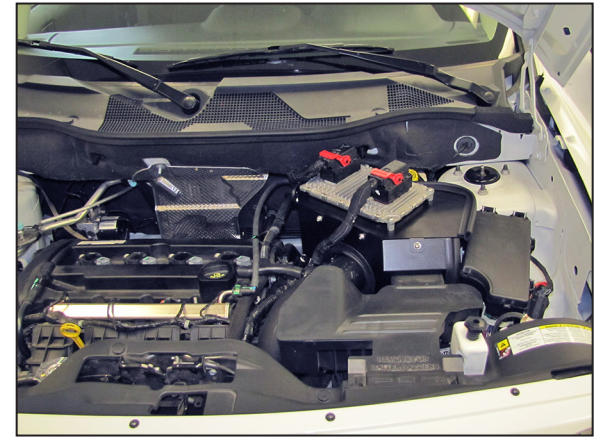

31. Reconnect the vehicle's negative battery cable. Double check to make sure everything is tight and properly positioned before starting the vehicle.

32. The C.A.R.B. exemption sticker, (attached), must be visible under the hood so that an emissions inspector can see it when the vehicle is required to be tested for emissions. California requires testing every two years, other states may vary.

33. It will be necessary for all K&N® high flow intake systems to be checked periodically for realignment, clearance and tightening of all connections. Failure to follow the above instructions or proper maintenance may void warranty.

ROAD TESTING:

1. Start the engine with the transmission in neutral or park, and the parking brake engaged. Listen for air leaks or odd noises. For air leaks secure hoses and connections. For odd noises, find cause and repair before proceeding. This kit will function identically to the factory system except for being louder and much more responsive.

2. Test drive the vehicle. Listen for odd noises or rattles and fix as necessary.

3. If road test is fine, you can now enjoy the added power and performance from your kit.

4. K&N Engineering, Inc., requires cleaning the intake system's air filter element every 100,000 miles. When used in dusty or off-road environments, our filters will require cleaning more often. We recommend that you visually inspect your filter once every 25,000 miles to determine if the screen is still visible. When the screen is no longer visible some place on the filter element, it is time to clean it. To clean and re-oil, purchase our filter Recharger® service kit, part number 99-5050 or 99-5000 and follow the easy instructions.

INTAKE SYSTEMS FOR VEHICLES LISTED ARE 50 STATE LEGAL. SEE KNFILTERS.COM FOR CARB STATUS ON EACH PART FOR A SPECIFIC VEHICLE.