

PAINLESS[®]

PERFORMANCE PRODUCTS



Trail Rocker Installation

Instructions

Jeep CJ7 1976-1986 Under-Dash Trail Rocker
For Installing Painless Part Number: 57021, 57022, & 57023
Manual # 90588

Painless Performance Products recommends you, the installer, read this installation manual from front to back before installing this harness.



Painless Performance Products, LLC

2501 Ludelle Street

Fort Worth, TX 76105-1036

800-423-9696 phone – 817-244-4024 fax

Web Site: www.painlessperformance.com

E-Mail: painless@painlessperformance.com

If you have any questions concerning the installation of this product, feel free to call Painless Performance Products' tech line at 1-800-423-9696. Calls are answered from 8am to 5pm central time, Monday thru Thursday, 8am-4:30pm Friday, except holidays.

Here we have provided you with accurate instructions for the installation of this product. However, if you have comments/suggestions concerning these instructions, please call or email us (our contact information can be found at the top of this page or online at www.painlessperformance.com). We sincerely appreciate your business.

Painless Performance Products, LLC shall in no event be liable in contract or tort (including negligence) for special, indirect, incidental, or consequential damages, such as but not limited to, loss of property, or any other damages, costs or expenses which might be claimed as the result of the use or failure of the goods sold hereby, except only the cost of repair or replacement.

Should you damage or lose part of your manual, a full color copy of these instructions can be found online at www.painlessperformance.com

Installation Manual: **90588**

1st Edition: February, 2017

Copyright © 2016 by Perfect Performance Products, LLC

TABLE OF CONTENTS

<u>PAGE #</u>	<u>SECTION</u>
4	<u>CONTENTS OF THE PAINLESS KIT</u>
5	<u>TOOLS NEEDED</u>
6	<u>FUSE/RELAY CENTER INSTALLATION</u>
19	<u>SWITCH PANEL INSTALLATION</u>
19	<u>UNDER-DASH 4-SWITCH PANEL INSTALLATION</u>
22	<u>UNDER-DASH 6-SWITCH PANEL INSTALLATION</u>
25	<u>UNDER-DASH 8-SWITCH PANEL INSTALLATION</u>
28	<u>SWITCH WIRING</u>
29	<u>DOUBLING SWITCH CONTROL WIRES</u>
32	<u>IGNITION SWITCH CONNECTOR INSTALLATION</u>
39	<u>RELAY OUTPUT WIRES</u>
47	<u>OPTIONAL: PAINLESS PART#: 57150 - WINCH CONTROL ADD-ON KIT</u>
51	<u>OPTIONAL: WINCH PIGTAIL</u>
52	<u>FINAL STEPS</u>
57	<u>FUSE REPLACEMENT</u>
59	<u>PAINLESS PERFORMANCE LIMITED WARRANTY AND RETURN</u>
	<u>POLICY</u>

CONTENTS OF THE PAINLESS KIT

Refer to the **Contents Figure** (below) to take inventory. See that you have everything you're intended to have in this kit. If you find that anything is missing or damaged, please contact the dealer where you obtained the kit or Painless Performance at (800) 423-9696.

The Painless Trail Rocker Kit should contain the following:

- Fuse/Relay Center
- Powder Coated Bracket
- Trail Rocker Switch Panel with pre-installed switches.
 - The number of switches varies between 4, 6, or 8 based on the kit purchased.
- Ignition Switch pigtail and weather-pack connector.
- Parts Kits
- This manual: 90588



SMALL PARTS

Included with the Painless harness are parts kits containing miscellaneous terminals, fuses, screws, and nuts. Many of the terminals are non-insulated and will require heat shrink to be applied after the terminal has been properly crimped. Heat shrink has been supplied. These non-insulated terminals allow you to keep a cleaner, more traditional look. When crimping these terminals, take notice to the split in the terminal. Make sure the smooth side of the jaw on the crimper goes towards this split.



TOOLS NEEDED

This installation primarily requires only basic hand tools that may include, but are not limited to:

1. Wrench sets SAE and Metric
2. Ratchet sets SAE and Metric
3. T20Torx bit
4. Screwdrivers:
 - a. (2) #2 Standard Length and Stubby Phillips Head
 - b. #0 "Jewelers" Flat (slot) Head
5. Half-round Metal File
6. Inch/Pound Torque Wrench
7. Wire Cutters or "Dykes"
8. Hand Crimpers
9. Cable Crimping Tool
10. Electrical and Masking Tape
11. Permanent Marker



In addition to these basic hand tools, you will need, at least, the following:

Electric Drill & Drill Bits:

You also need an Electric Power Drill (suggest battery powered cordless for ease and maneuverability) and the following bits:

1. Drill bits
 - a. 1/4"
 - b. 1/8"
2. 1 1/4" Hole Saw with Arbor
3. 1/4" - 3/4" X 1/16" #3 Step Drill Bit



Volt/Ohm Meter:

A Volt/Ohm meter is always a good tool to have on hand when installing any type of electrical component into a vehicle. The most basic meters provide the two functions required to diagnose electrical issues commonly seen during a harness install: voltage measurement and continuity testing. Voltage measurement is the ability to read DC voltage. Continuity testing allows you to test



Heat Gun: Very useful to shrink the heat-shrink found in the parts kit.

FUSE/RELAY CENTER INSTALLATION

The following steps **MUST** be followed as they are printed. Do not move onto other parts of the installation out of sequence.

CAUTION: BEFORE THE INSTALLATION OF THIS PRODUCT, DISCONNECT THE POWER FROM YOUR VEHICLE BY REMOVING THE NEGATIVE BATTERY CABLE FROM THE BATTERY. THE BATTERY SHOULD NOT TO BE RECONNECTED UNTIL INSTRUCTED

Step 1: Locate your battery and remove the cables, beginning with the negative (-) cable.



Step 2: Then, unbolt the battery hold-down and remove the battery completely.

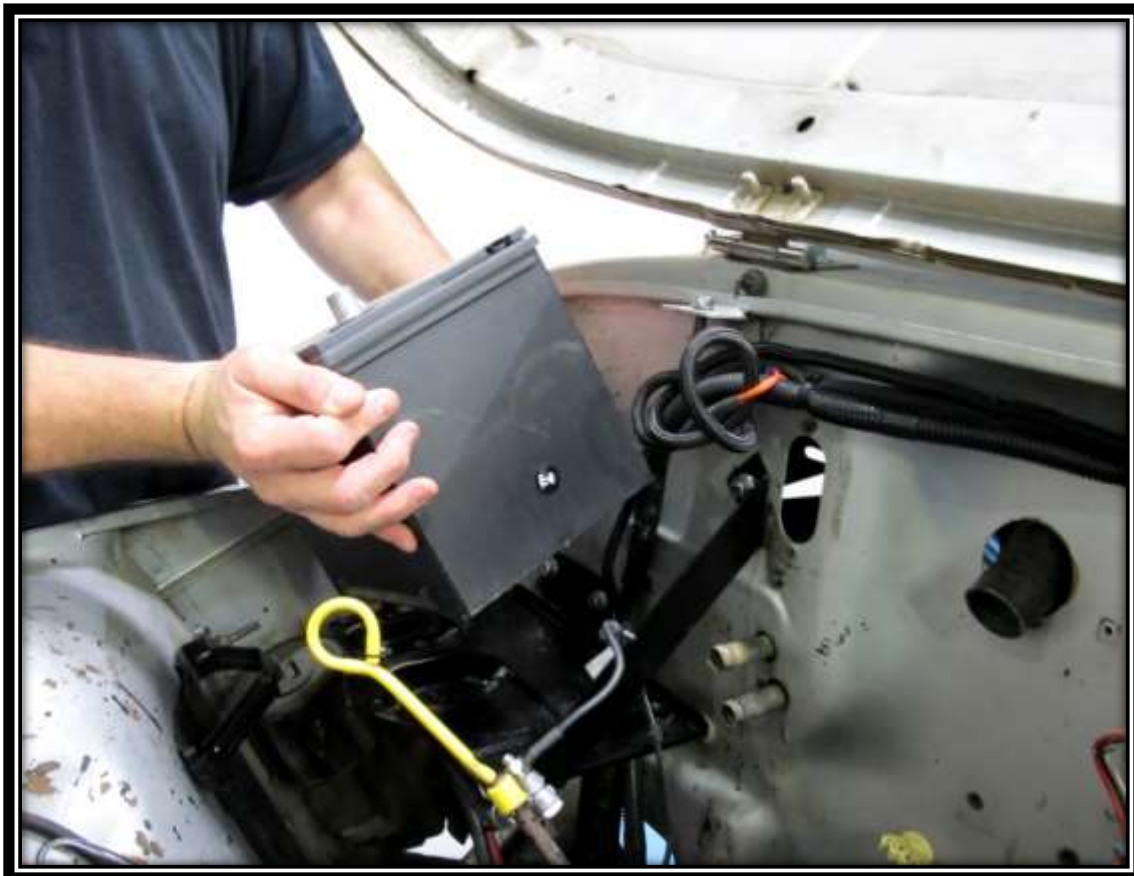
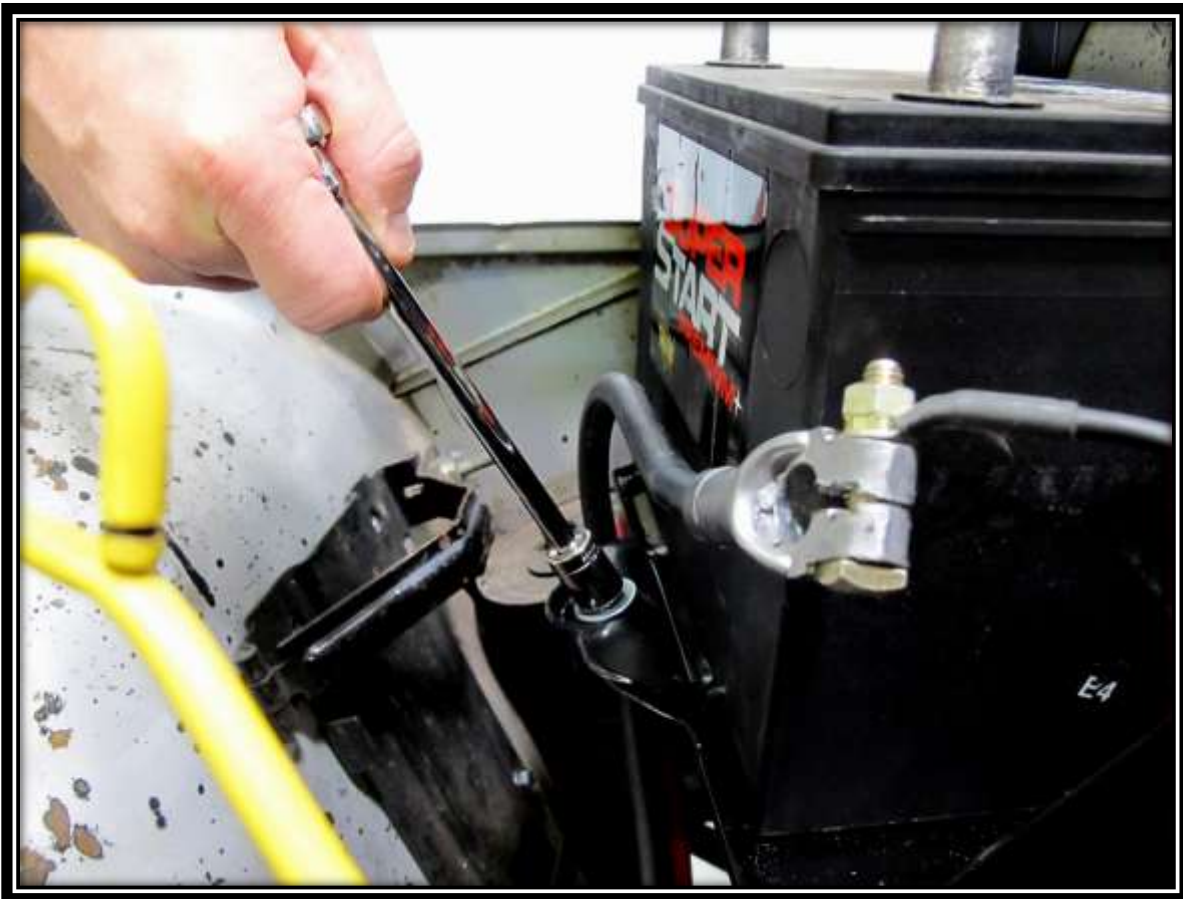

Step 3: Inside the engine compartment, locate the jack holder bolted to the passenger side, front fender well. Remove the top two bolts from the jack holder. This is where you mount the Fuse/Relay Center.



Step 4: Mount the Fuse/Relay Center bracket on top of the fender well and slide the end of the bracket behind the jack holder. Loosely, reinstall the bolts thru the bracket holes. You will move the bracket again after marking the mounting hole you will create in Step 6.



Step 5: If a hole does not exist on the fender well, drill one in order to secure and mount the Fuse/Relay Center bracket to the vehicle. Locate the mounting tab on the side of the bracket and use a [permanent marker](#) to mark the place your hole will be drilled.

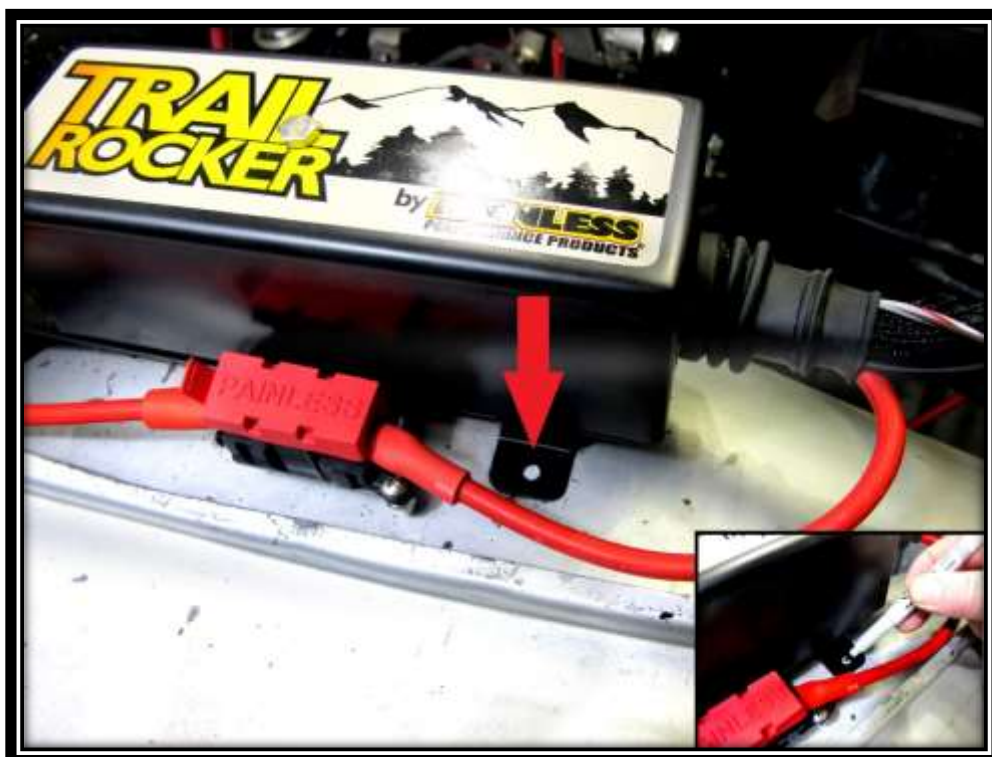

Step 6: Temporarily remove the bracket and set it aside. Use a $\frac{1}{4}$ " bit to drill a small hole in the fender well where you made your mark in Step 5.

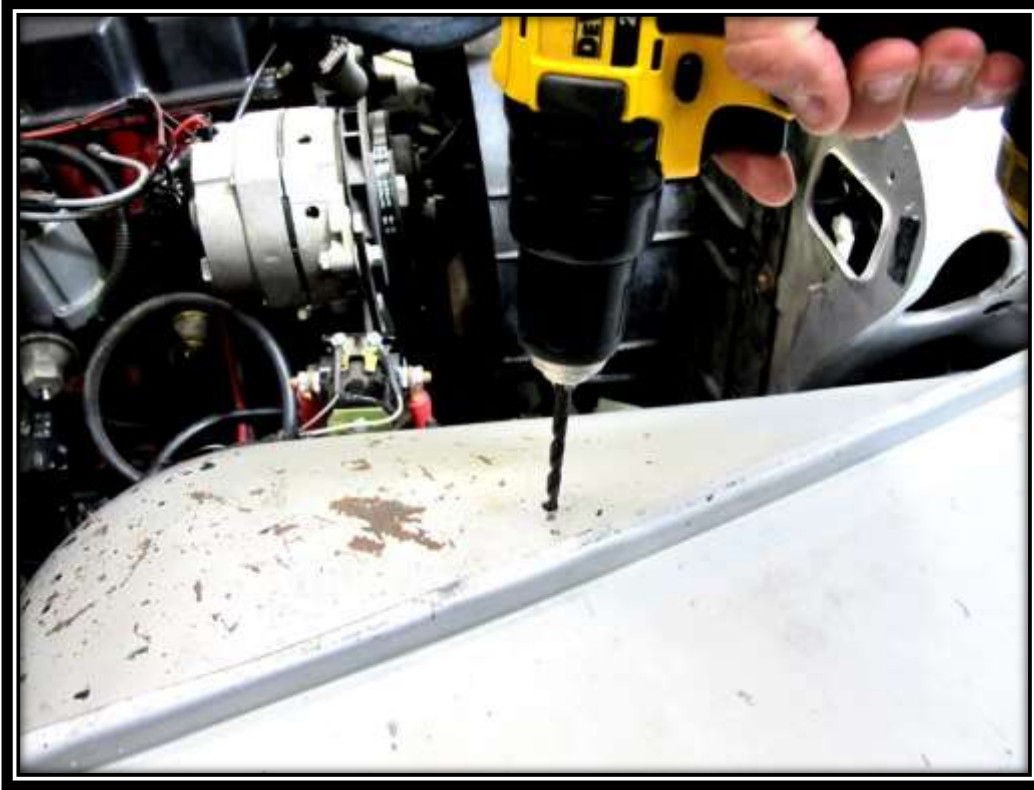

Step 7: Again, mount the Fuse/Relay Center bracket just as you did in Step 4, and secure the assembly to the vehicle. To do this, first, replace and tighten the bolts for the jack holder, securing the bracket behind it.

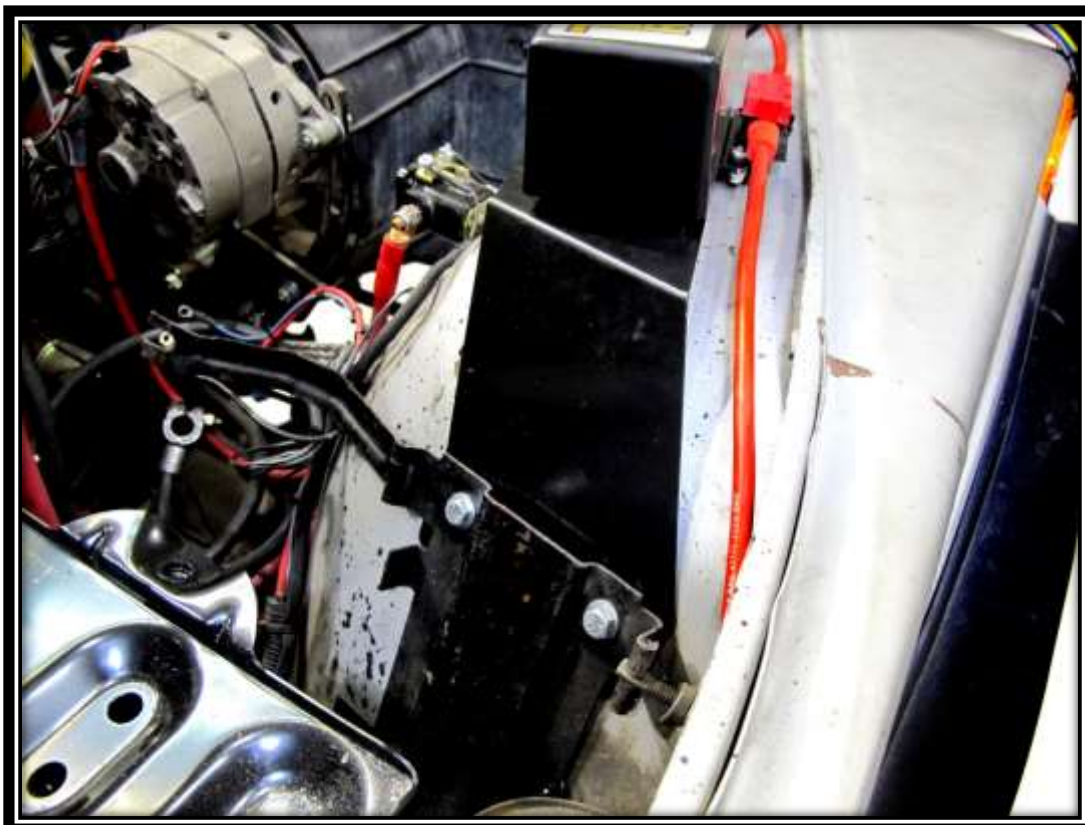

Step 8: Locate (1) ¼" – 20 X ¾" bolt, (1) flat washers, and (1) ¼" lock nut from the included parts kit. With a 7/16" socket and 7/16" wrench, bolt the bracket to the fender well using the hole you created on Step 6.



Step 9: At this point, your **Fuse/Relay Center** should appear as it does below.



Step 10: Now that the assembly is securely fastened to the vehicle, locate the **Switch Control wires** and **Fuse/Relay Center ground wire**.

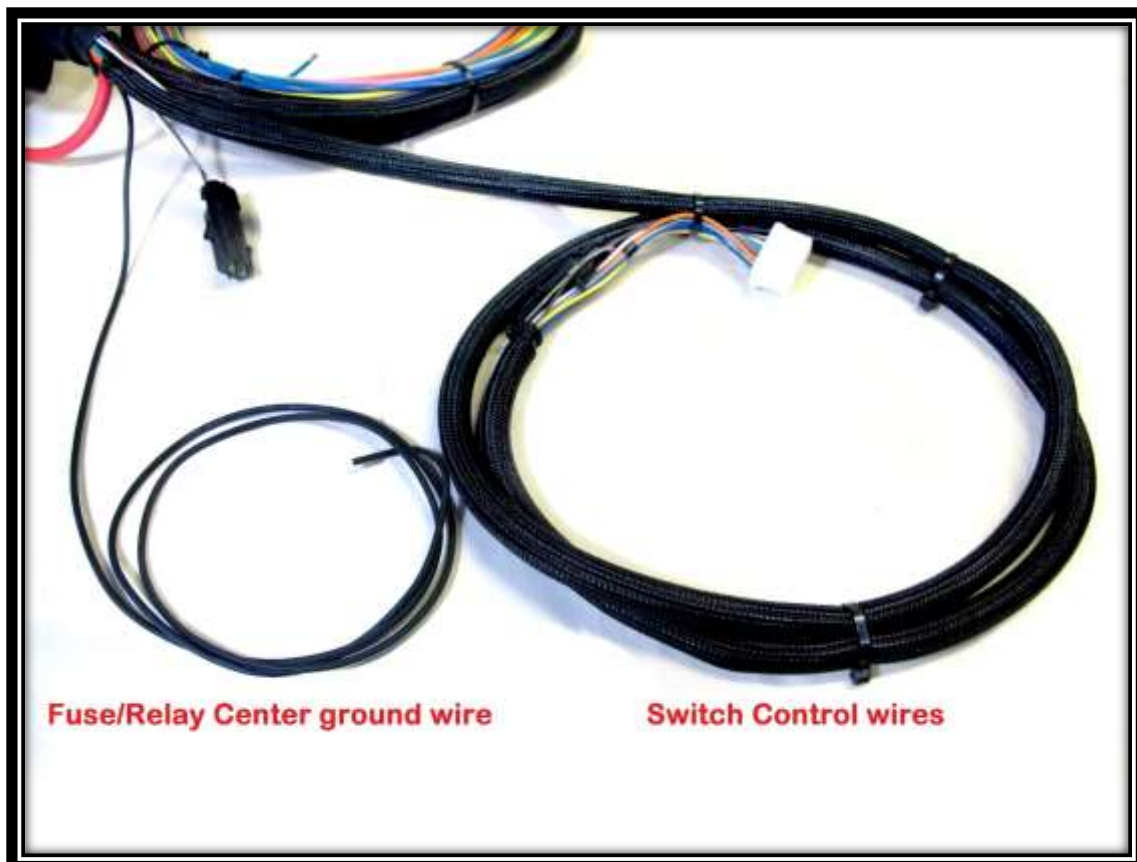

Step 11: Route the Switch Control wires and ground wire along the top of the Fuse/Relay Center and back toward the firewall. Then, use (2) ¾" Adel clamps, (2) ¼" Nylock nuts, and (2) ¼"-20 bolts, found in the included parts kit, to mount the harness to the bracket. **Caution: Do not over-torque these fasteners! Use a torque wrench to torque to 24 inch pounds.**



Step 12: After securing the **Switch Control** wires and **ground wire**, they should be routed toward the firewall.



Step 13: Notice two tabs on the side of the battery tray support. Using **zip-ties**, found in the included parts kit, secure the **Switch Control** wires and **ground wire** to the lower tab. Then, secure just the **Switch Control** wires to the higher tab and remove the excess material from the **zip-ties**.



Step 14: Drill a hole in the firewall in order to route the **Switch Control wires** to the interior of the vehicle. First, start by measuring where to make the hole. Use the included **rubber grommet** as a reference and mark off a space roughly **2 ¾"** from the top and **3"** to the right of the battery tray support bolt's center line.



Step 15: Use a **1 ¼"** **hole-saw w/ arbor** to cut a hole in the firewall. Use a **half-round file** to de-bur the hole before installing the **rubber grommet**. **Before drilling, look behind the firewall to make sure the area is clear!**



Step 16: Locate the **rubber grommet** in the included parts kit and slide it over the **Switch Control wire connector** and then through the hole made in **Step 15**.



Step 17: When finished, everything should appear as it does below. Now, move to the interior of the vehicle.



Step 18: From the passenger side floorboard, under the dash, you can see the hole you made and the **Switch Control** wires coming through. Route the wires toward the center of the vehicle along the back of the firewall, above the **heater housing**, and behind the **upper defroster duct**.

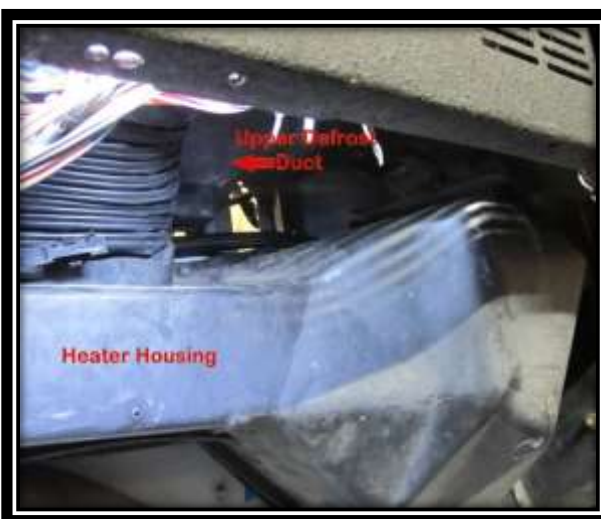

Step 19: The harness should come out behind and above the heater housing.

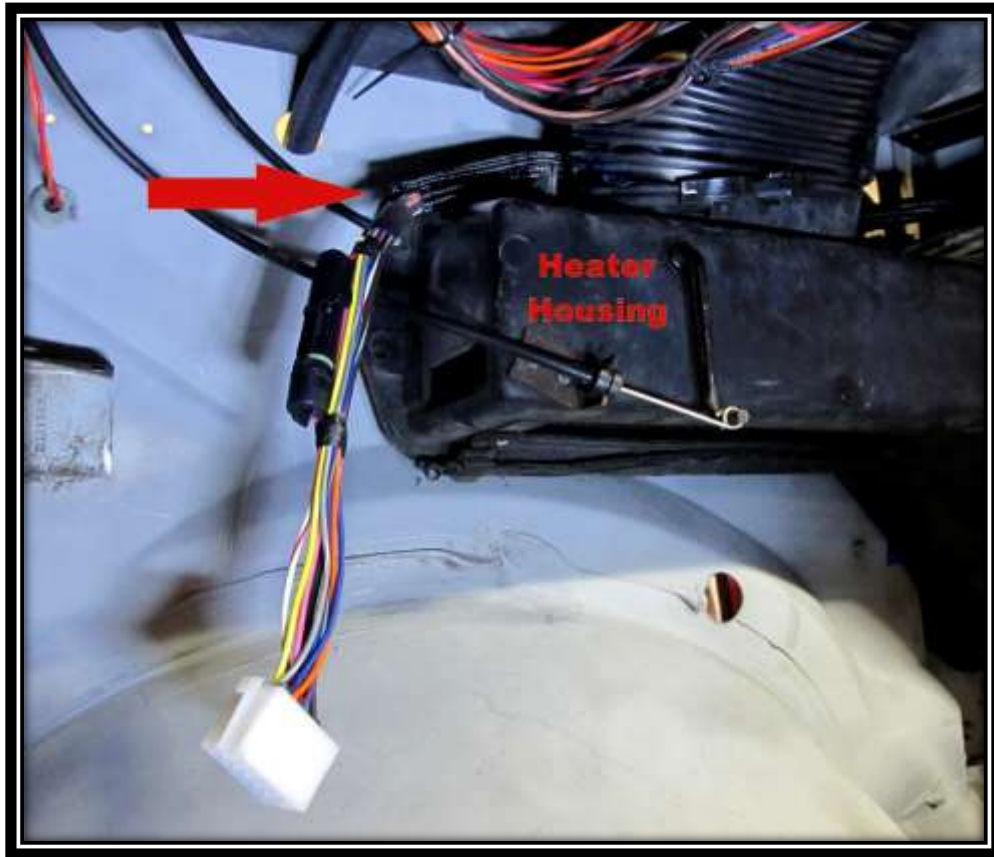

Step 20: The Switch Control wires should drop down below the dash, right under the speedometer. Zip-tie the end of the harness to the speedometer cable so that it is up and out of the way.

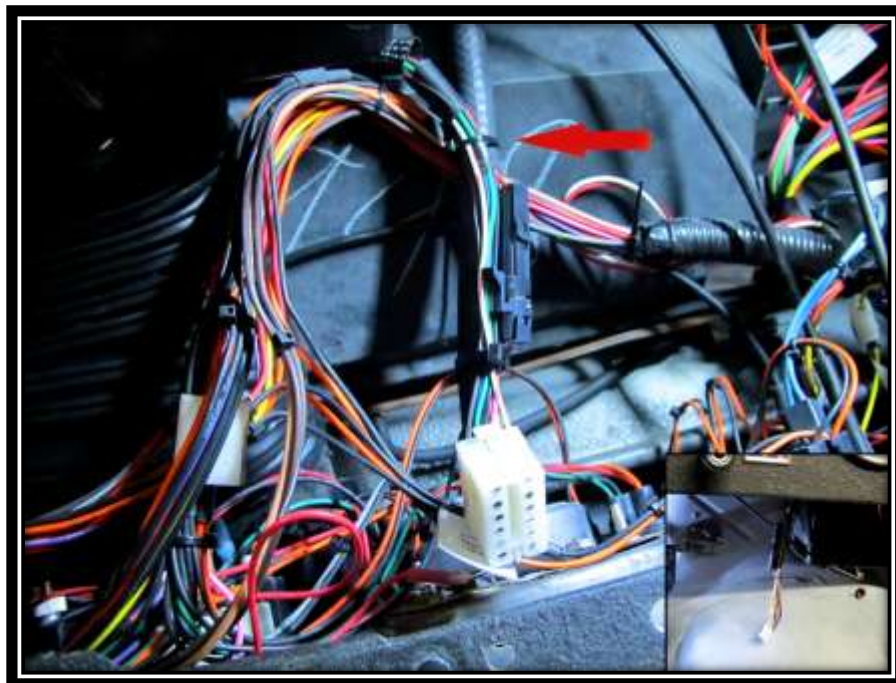

SWITCH PANEL INSTALLATION

The following pages give steps for the installation of one of three different Trail Rocker Switch Panels depending on the kit purchased. Please refer to the table of contents on [page 3](#) to locate the page number for the particular Trail Rocker Switch Panel you purchased.

UNDER-DASH 4-SWITCH PANEL INSTALLATION

Step 21: On the underside of most 1976 – 1986 CJ dashes you will find a series of $\frac{1}{4}$ " holes. You will use these to mount your under-dash 4-Switch Panel. If the dash of your CJ lacks these holes, use a $\frac{1}{4}$ " drill bit to create (2) $\frac{1}{4}$ " holes 1 $\frac{7}{8}$ " apart.

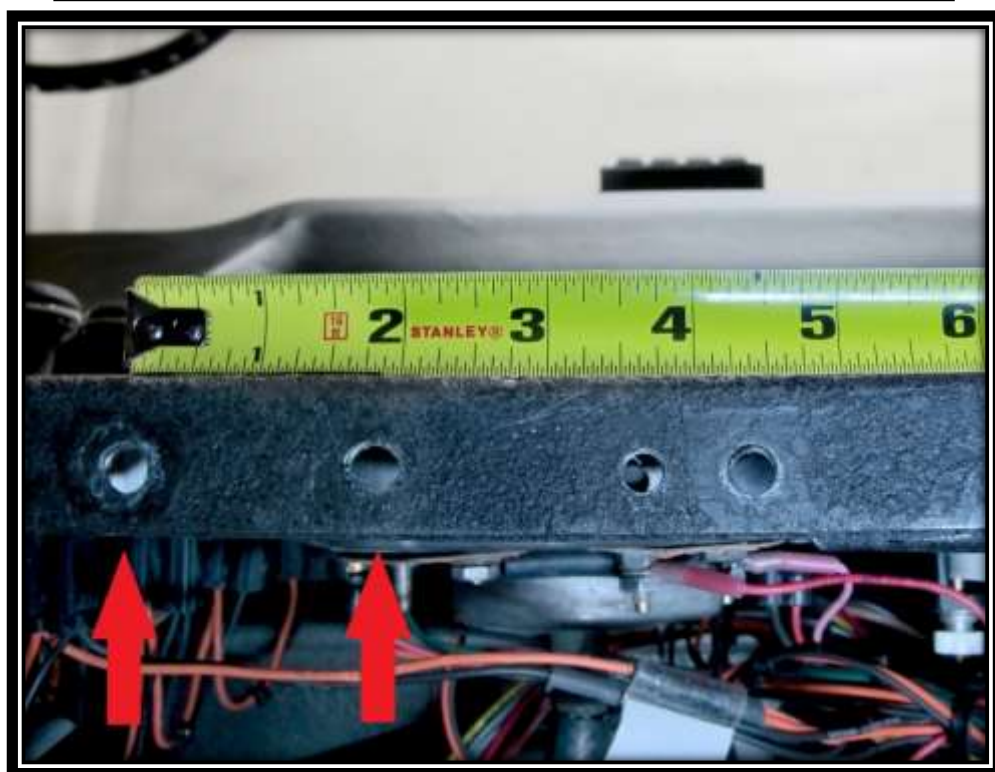
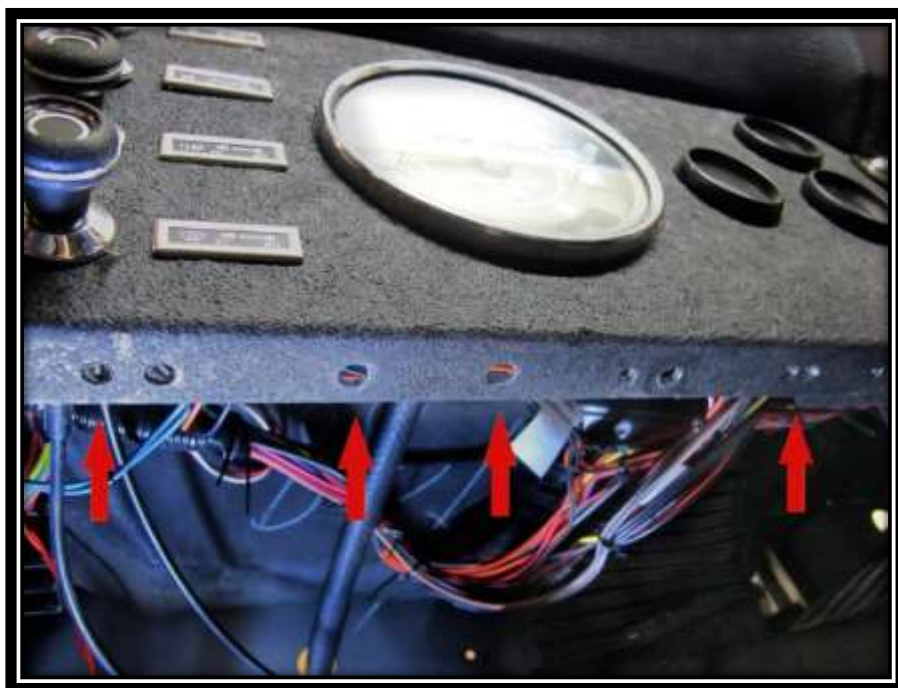

Step 22: Line up the bolts of the 4-Switch Panel's mounting bracket with the holes and attach it using (2) ¼" flat washers and (2) ¼" lock nuts found in the included parts kit.

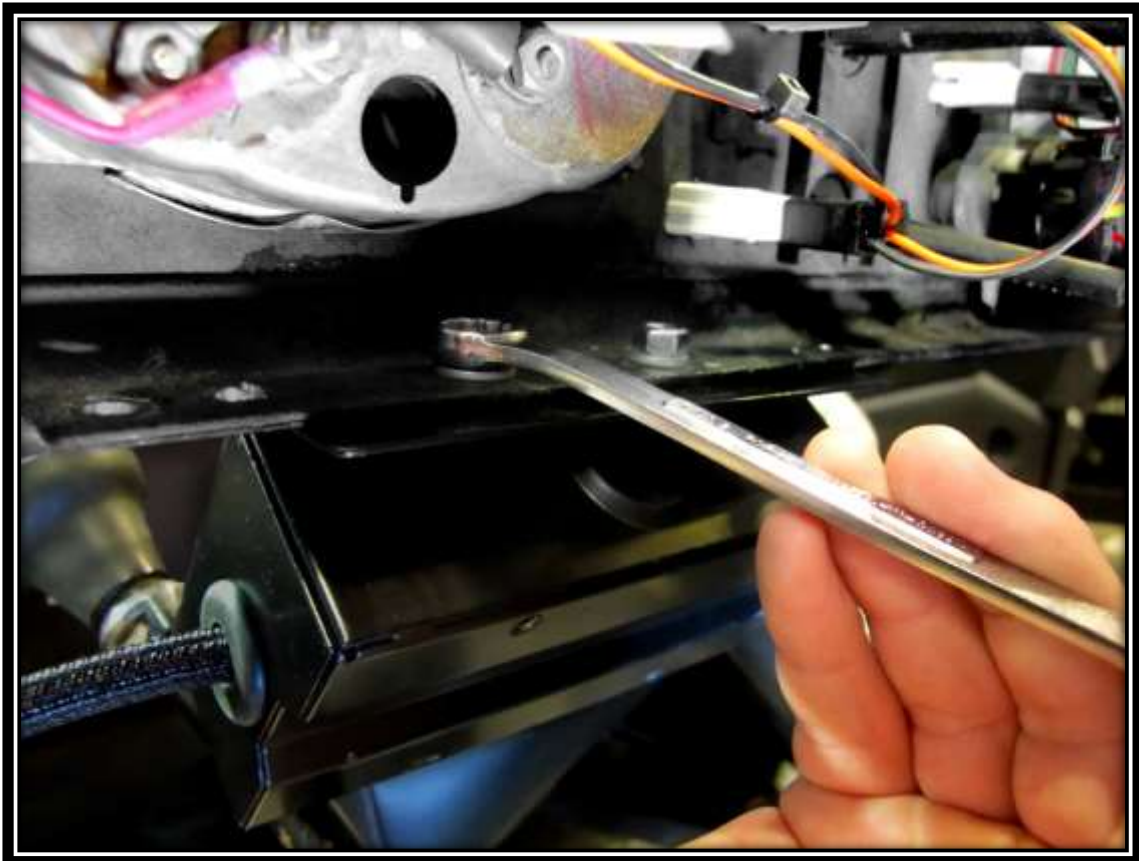

Step 23: After you securely mounted the 4-Switch Panel to the underside of the dash, locate the short pigtail coming from the right side of the panel and the interior wiring harness from **Step 10 – 20**. Join these two connectors and then move on to [page 28](#).



UNDER-DASH 6-SWITCH PANEL INSTALLATION

Step 24: On the underside of most 1976 – 1986 CJ dashes you will find a series of $\frac{1}{4}$ " holes. You will use these to mount your under-dash 6-Switch Panel. If the dash of your CJ lacks these holes, use a $\frac{1}{4}$ " drill bit to create (2) $\frac{1}{4}$ " holes $4\frac{3}{8}$ " apart.

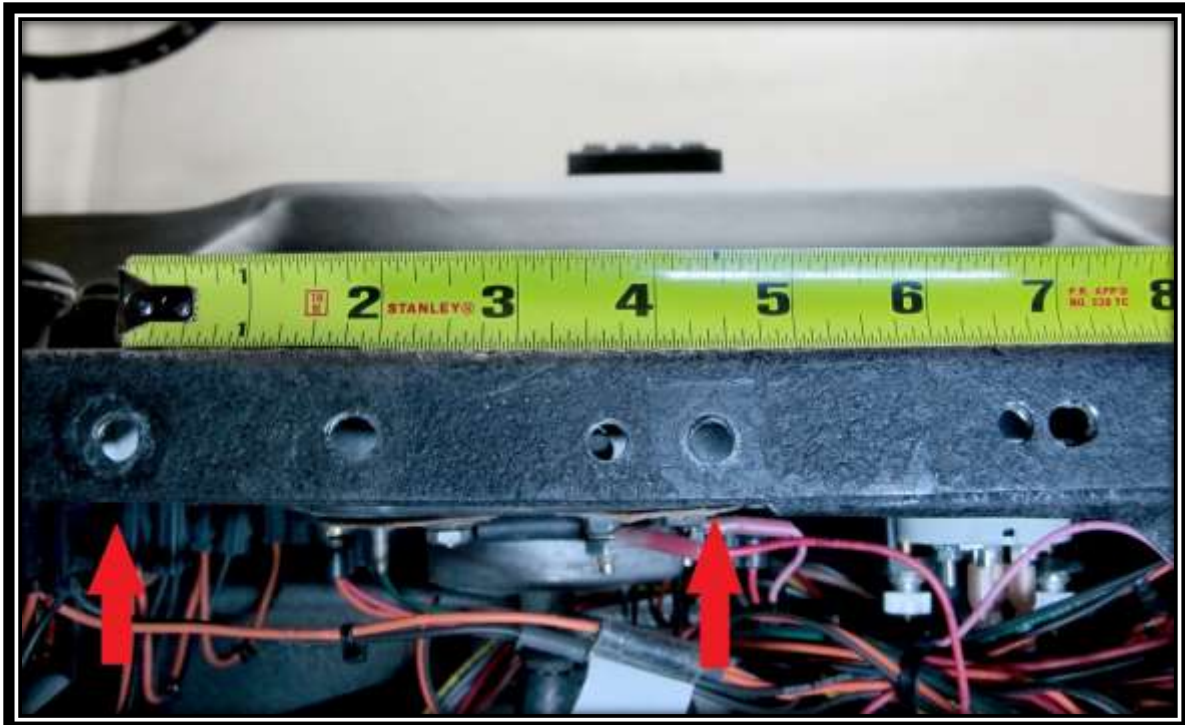

Step 25: Line up the bolts of the 6-Switch Panel's mounting bracket with the holes and attach it using (2) ¼" flat washers and (2) ¼" lock nuts found in the included parts kit.

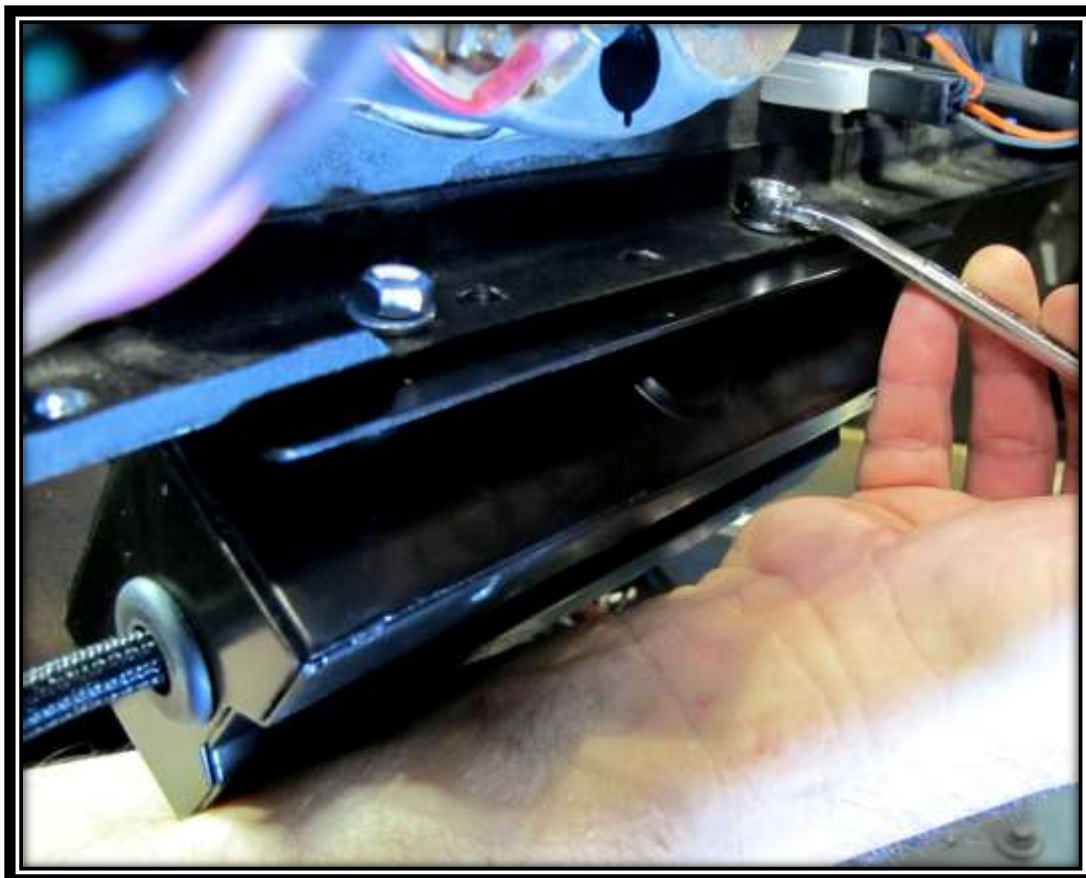

Step 26: After you securely mounted the Trail Rocker 6-Switch Panel to the underside of the dash, locate the short pigtail coming from the right side of the panel and the interior wiring harness from **Step 10 – 20**. Join these two connectors and then move on to [page 28](#).

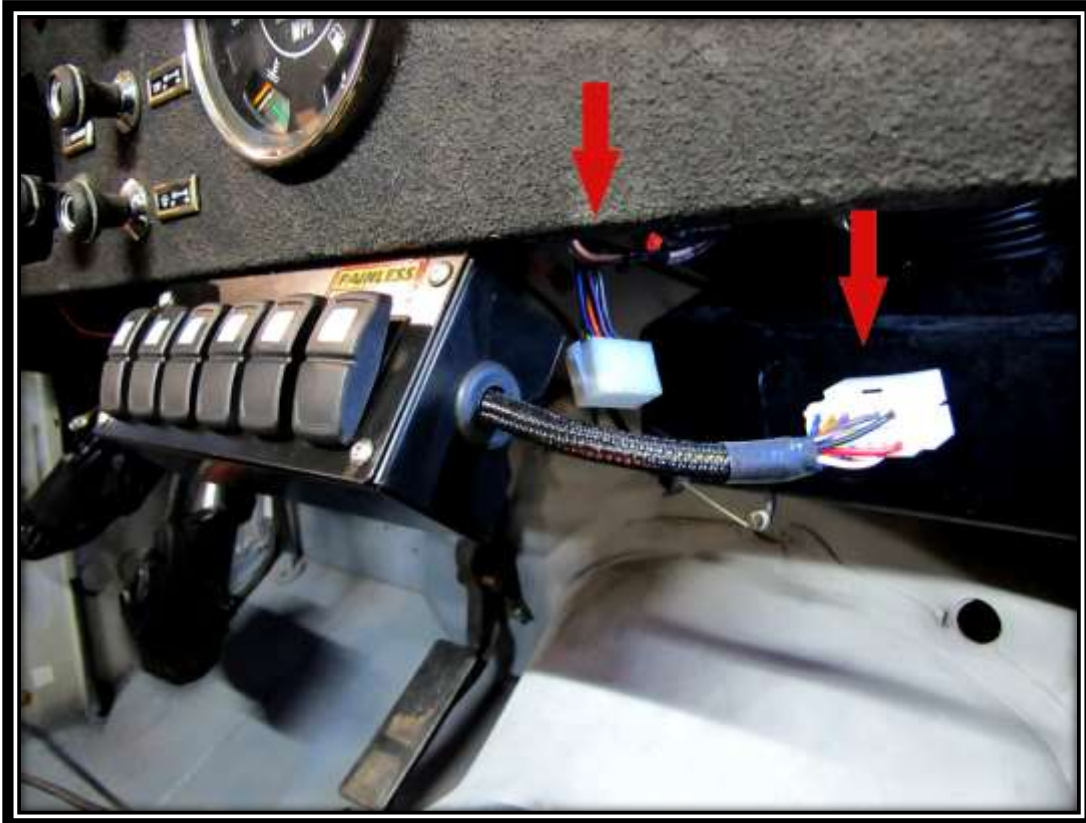

UNDER-DASH 8-SWITCH PANEL INSTALLATION

Step 27: On the underside of most 1976 – 1986 CJ dashes you will find a series of $\frac{1}{4}$ " holes. You will use these to mount your under-dash 8-Switch Panel. If the dash of your CJ lacks these holes, use a $\frac{1}{4}$ " drill bit to create (2) $\frac{1}{4}$ " holes $6\frac{7}{8}$ " apart.



Step 28: Line up the bolts of the 8-Switch Panel's mounting bracket with the holes and attach using (2) ¼" flat washers and (2) ¼" lock nuts found in the included parts kit.



Step 29: After you securely mounted the Trail Rocker 8-Switch Panel to the underside of the dash, locate the short pigtail coming from the right side of the panel and the interior wiring harness from Step 10 – 20. Join these two connectors and then move on to [page 28](#).

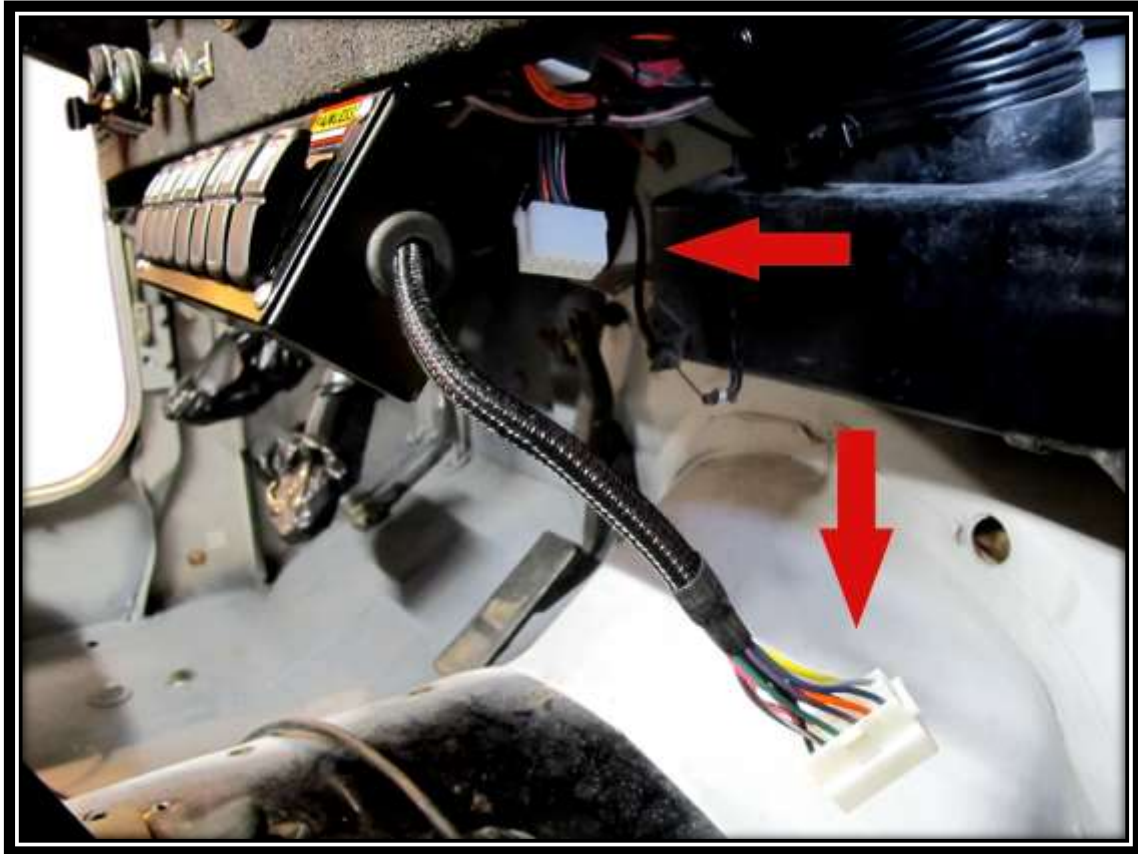

SWITCH WIRING

The lighted rocker switches included in your kit are wired as shown in the diagram below.

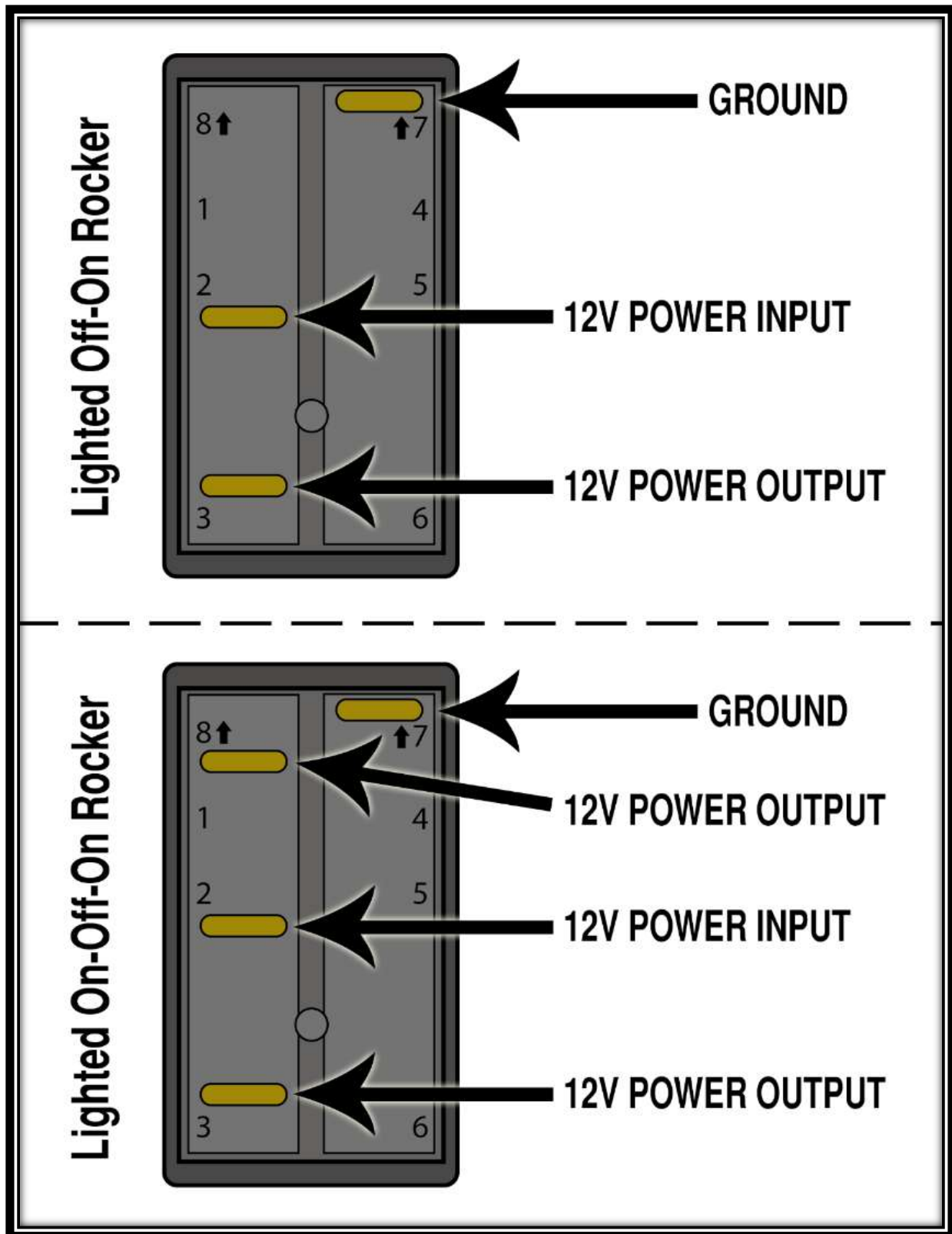

DOUBLING SWITCH CONTROL WIRES

Steps 30-33 are optional and only for those who wish to control multiple functions for one switch. Provided in the kit are some 16ga. – 14ga. terminals, similar to those shown below.



Step 30: Choose which switch you want to control multiple functions with, and disconnect the existing Switch Panel wire from the terminal on the bottom of the switch (terminal #3).

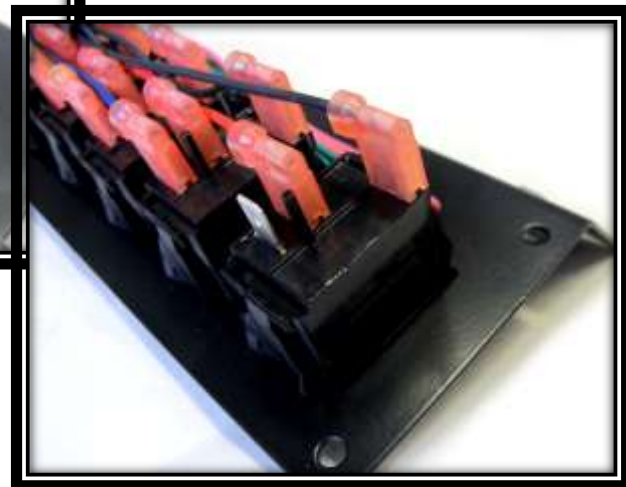
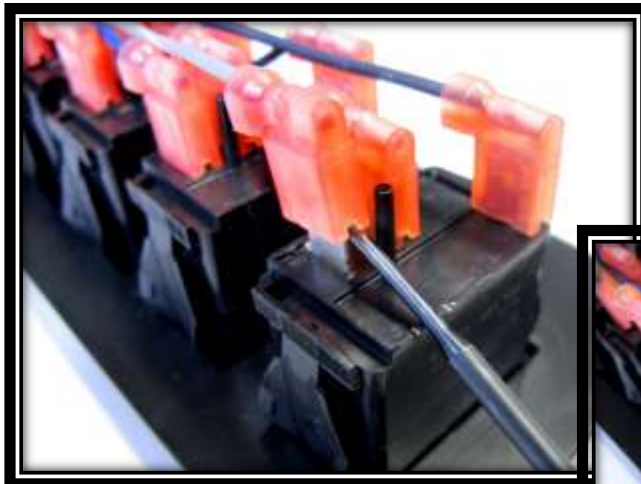

Step 31: With the **Switch Panel** wire removed from the switch, cut off the terminal, and strip the wire $\frac{1}{4}$ ".

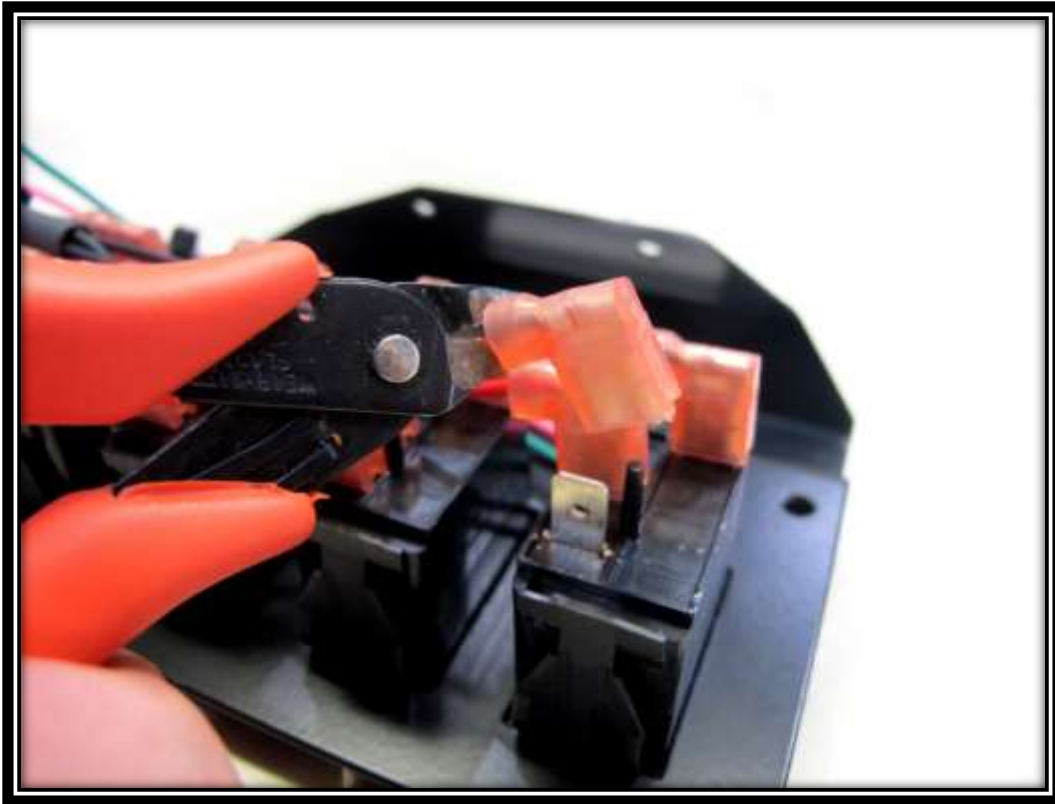

Step 32: Take the **Switch Panel** wire you just stripped and one of the additional **Switch Panel** wires; then slide them together into a **16-14 ga. terminal** provided in the included parts kit.

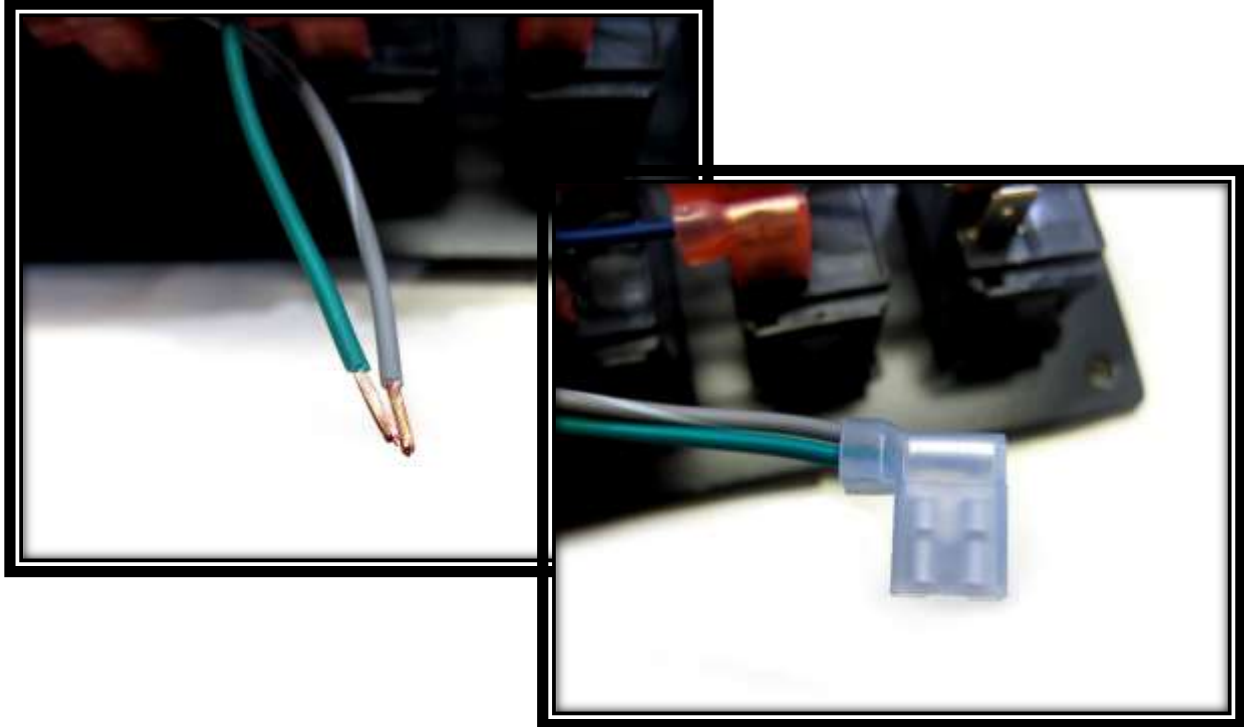

Step 33: With both wires inside, crimp the terminal, and reconnect the doubled **Switch Panel** wires to the switch.

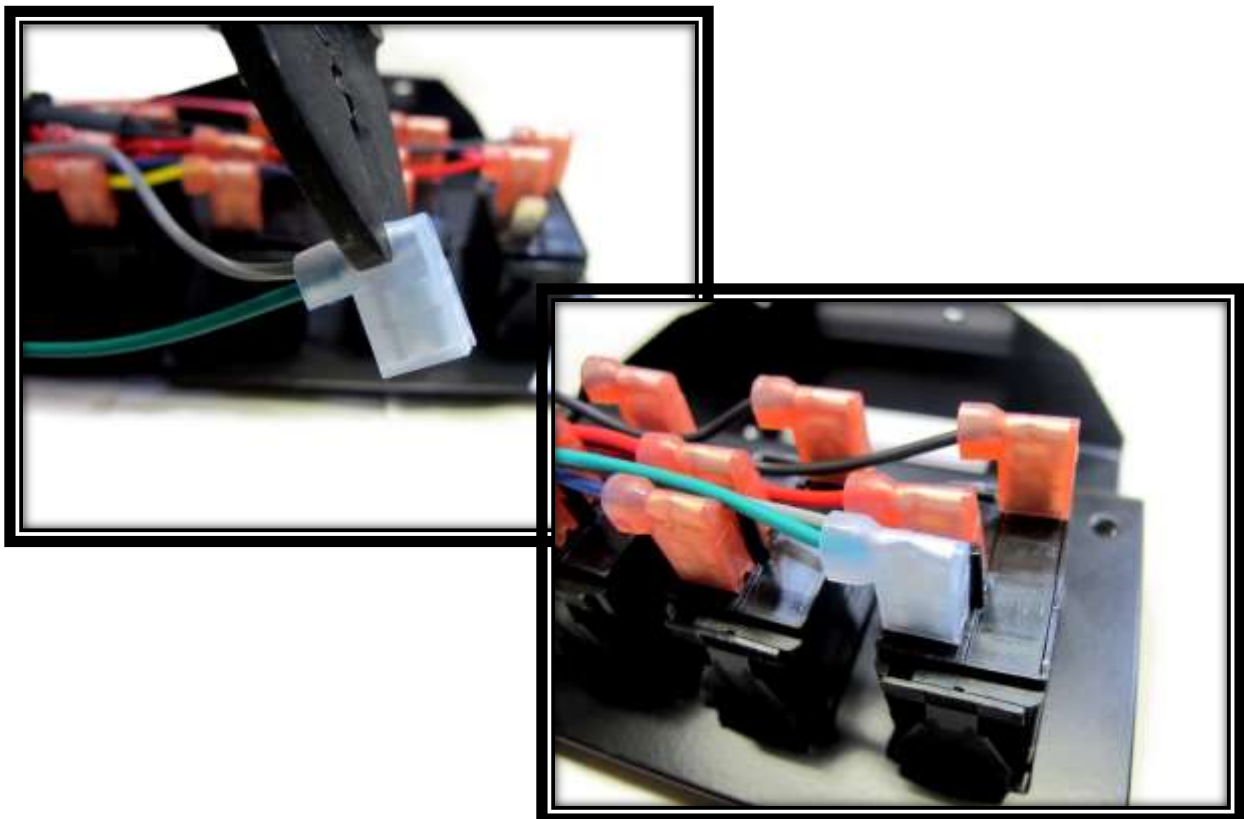

IF YOU WANT TO OPERATE YOUR SWITCHES WITH A CONSTANT POWER (AS SHIPPED), SKIP STEPS 34-42. THESE STEPS ILLUSTRATE HOW TO HOOK UP YOUR TRAIL ROCKER TO IGNITION SWITCHED POWER AND ARE COMPLETELY OPTIONAL

IGNITION SWITCH CONNECTOR INSTALLATION

Step 34: It will help to familiarize yourself with the *Ignition Switch Schematic* below.

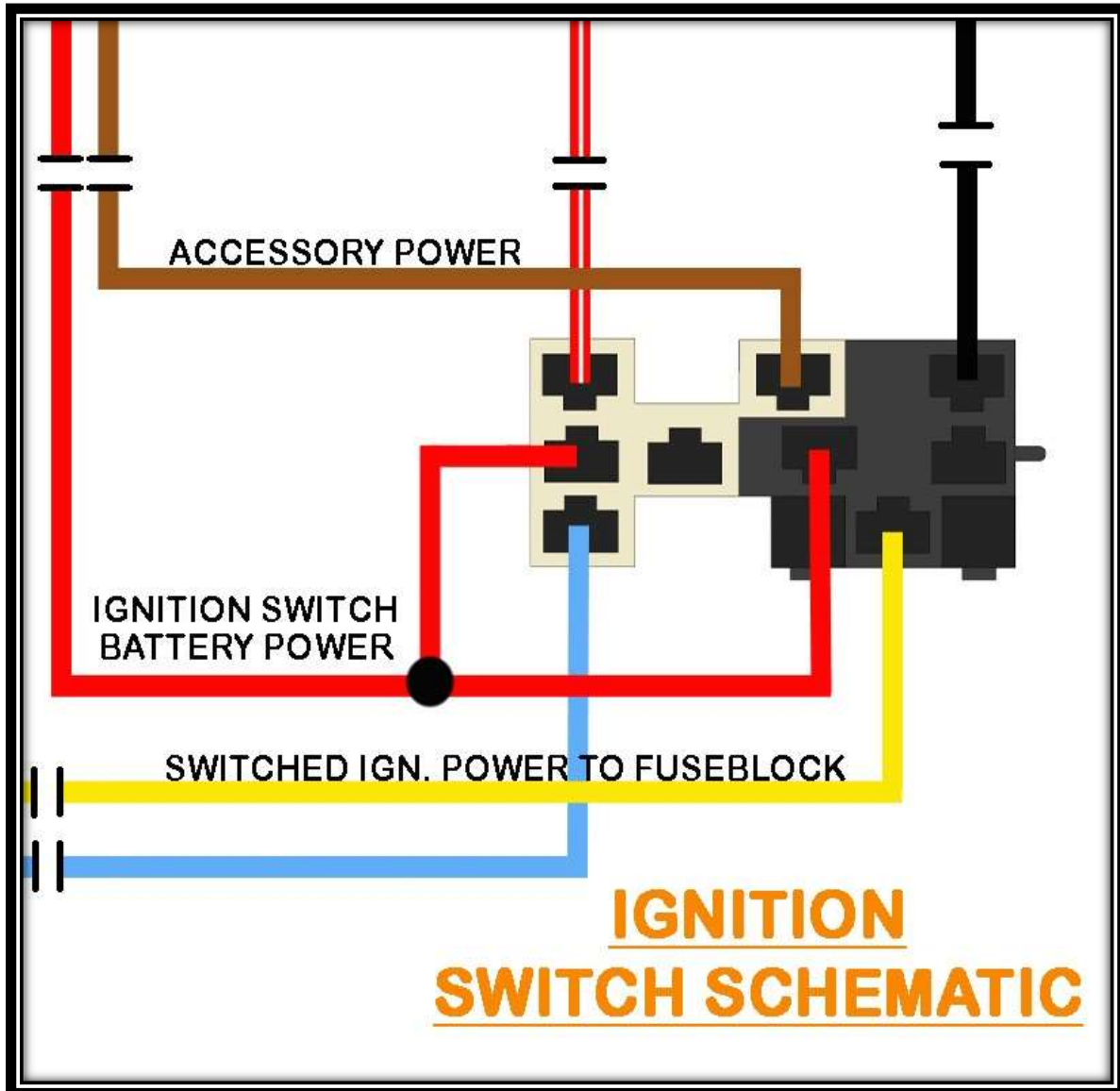

Step 35: Then, locate your vehicle's ignition switch on the steering column and the **YELLOW**, switched, ignition power wire. In this example the **YELLOW** wire, is plugged into the **BLACK** connector. These connectors may vary between model years and package options.

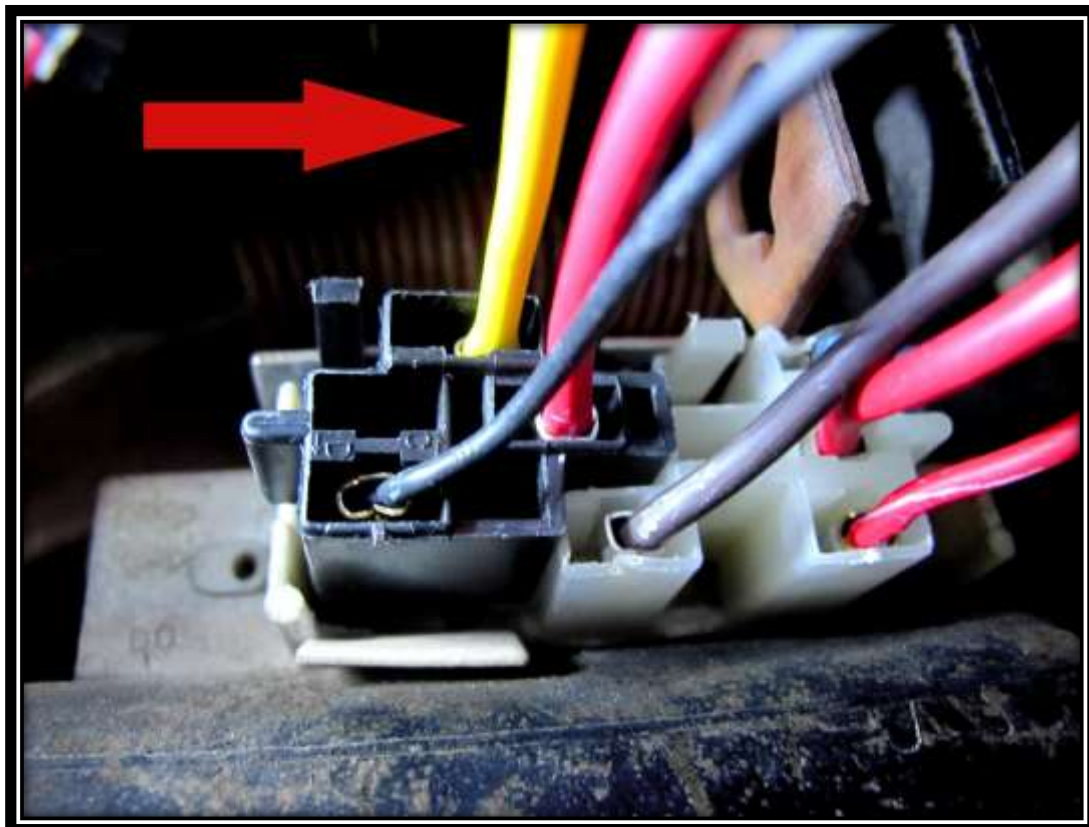
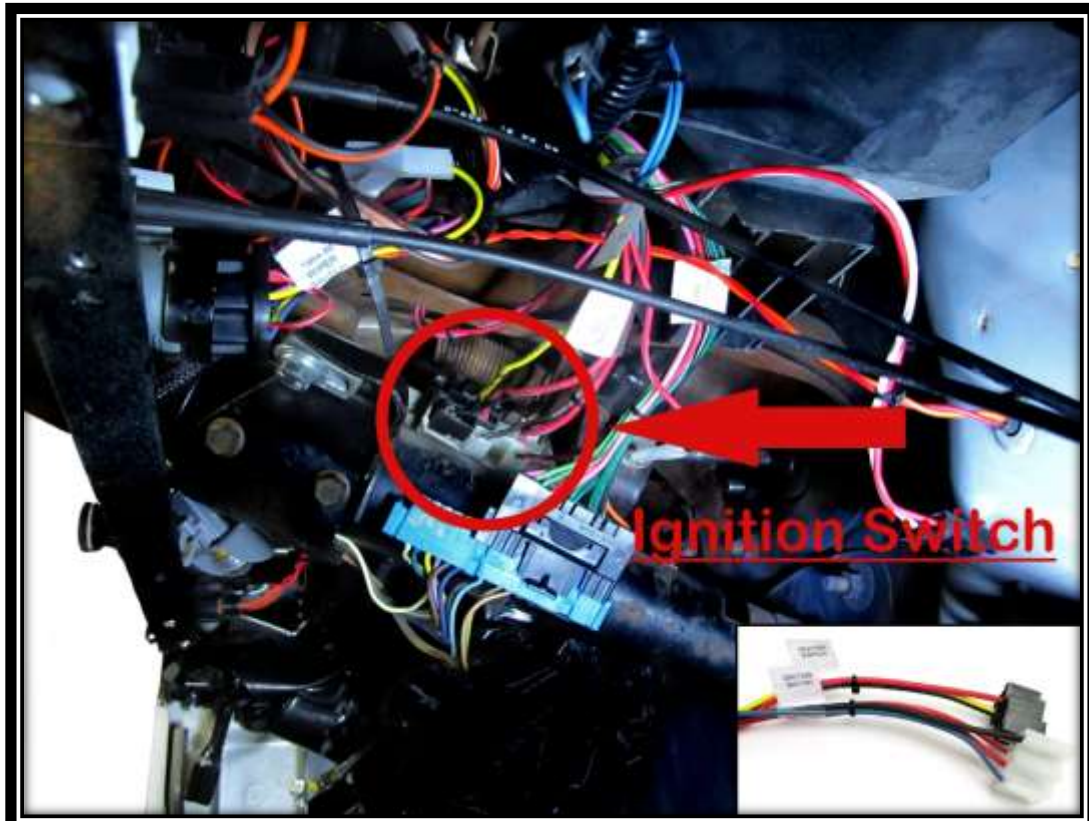

Step 36: Use a #0 “Jewelers,” flat-head screwdriver to unplug the BLACK connector from the ignition switch and remove the terminal of the wire from the connector.

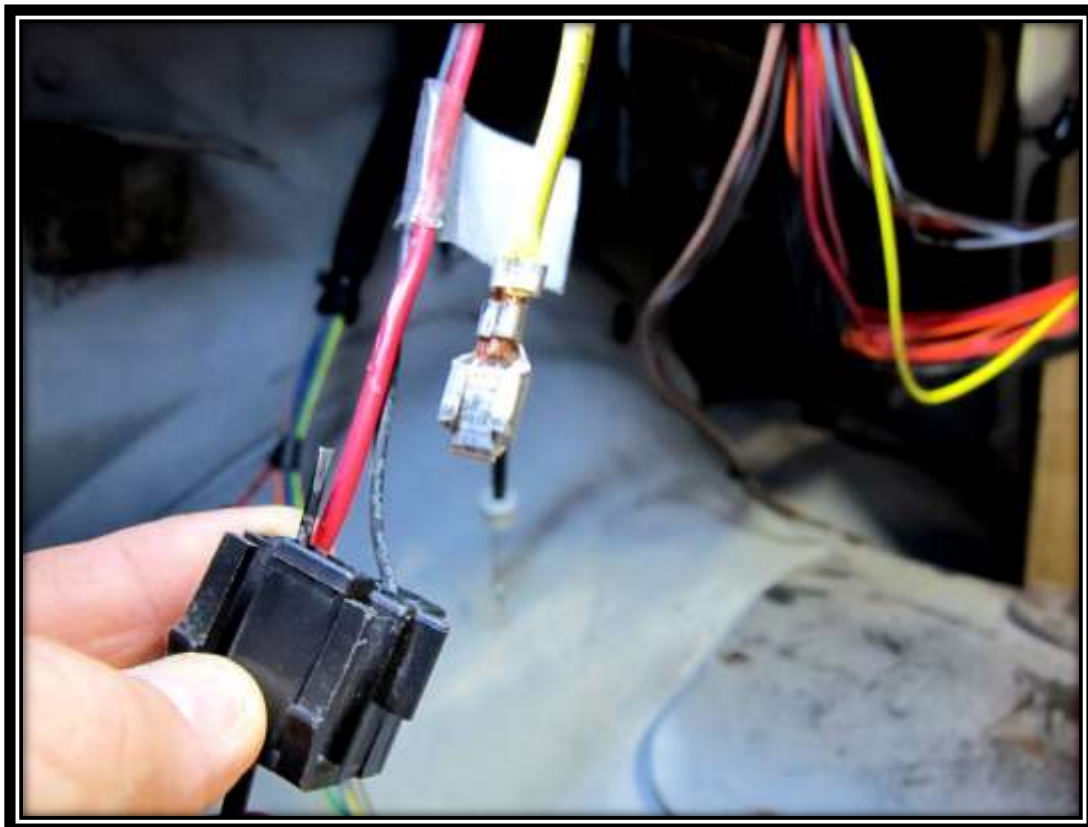
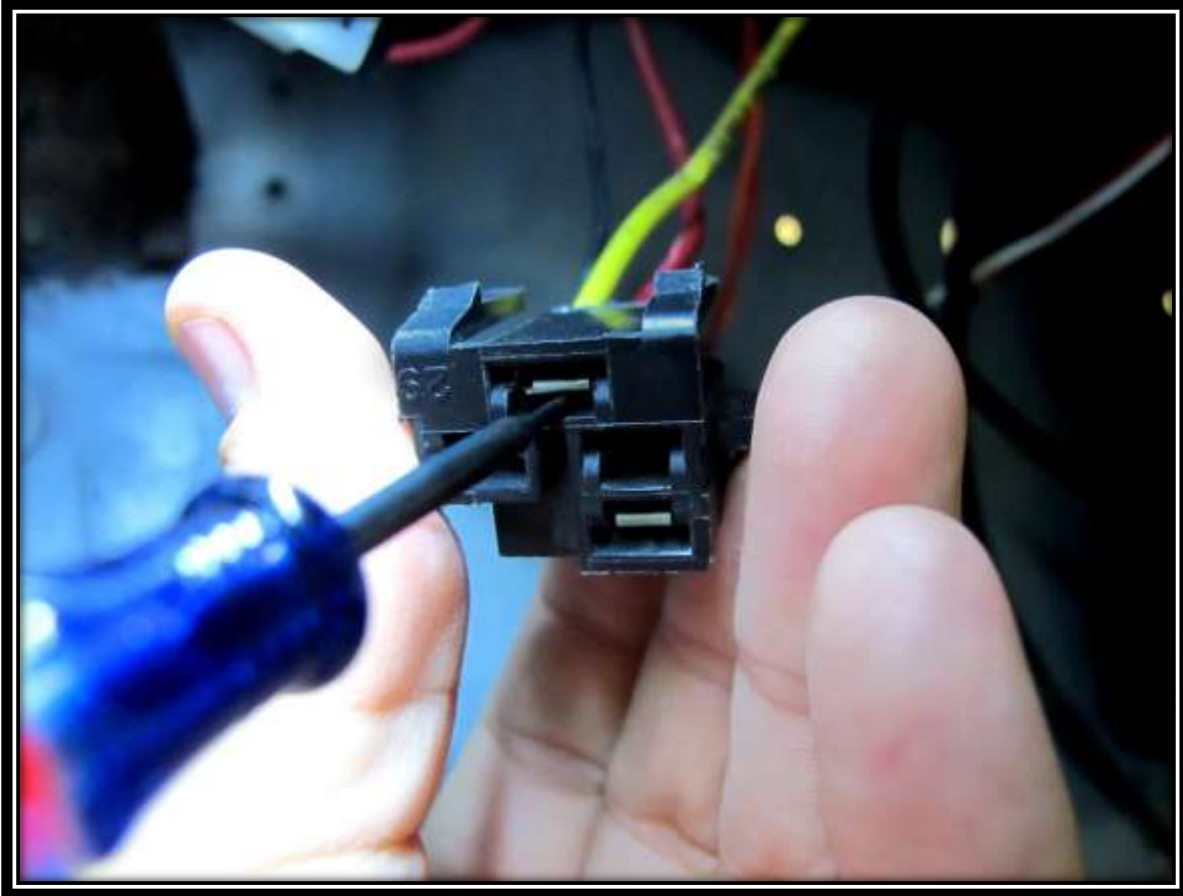

Step 37: Locate the **ignition pigtail** included in your kit. Insert the exposed terminal from the **ignition pigtail** into the slot on the factory connector that you removed the switched, ignition power wire from.

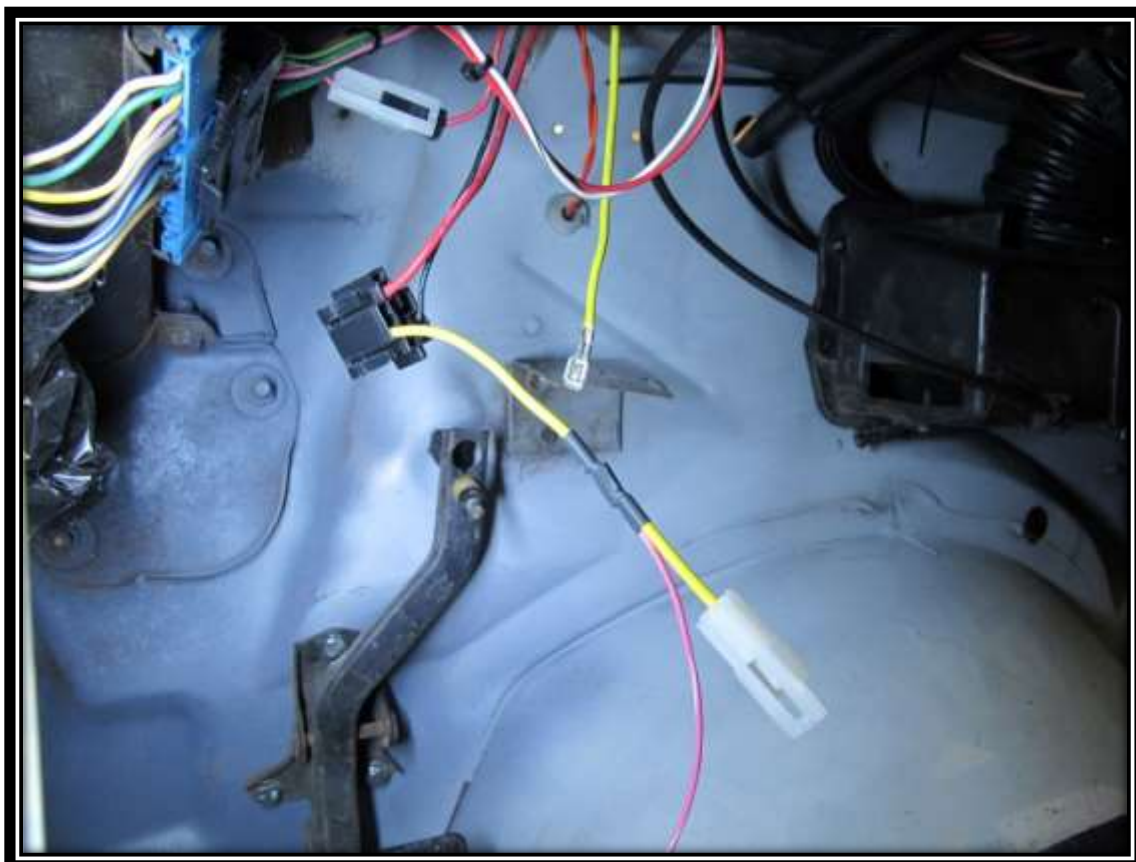
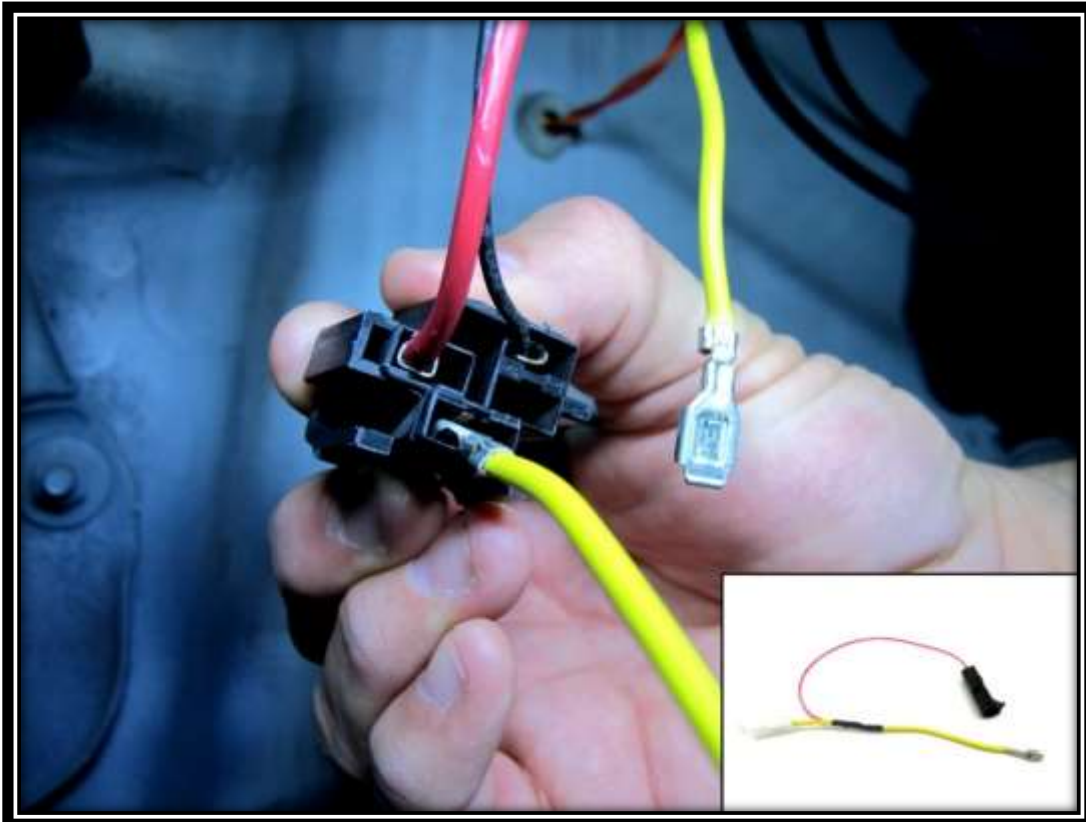

Step 38: Locate the switched, ignition power wire you removed from the factory connector in **Step 36**. Insert the terminal into the black, single-wire connector included in your Trail Rocker Kit.

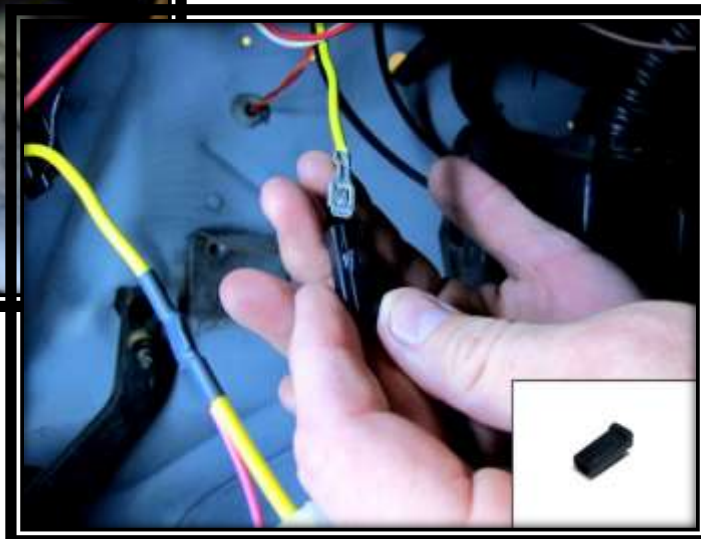
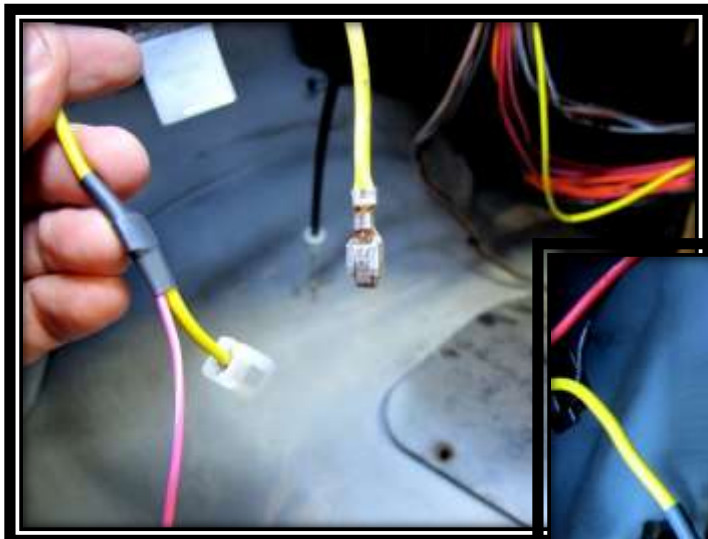

Step 39: With the connector installed on the switched, ignition power wire, plug it into the **ignition pigtail**.

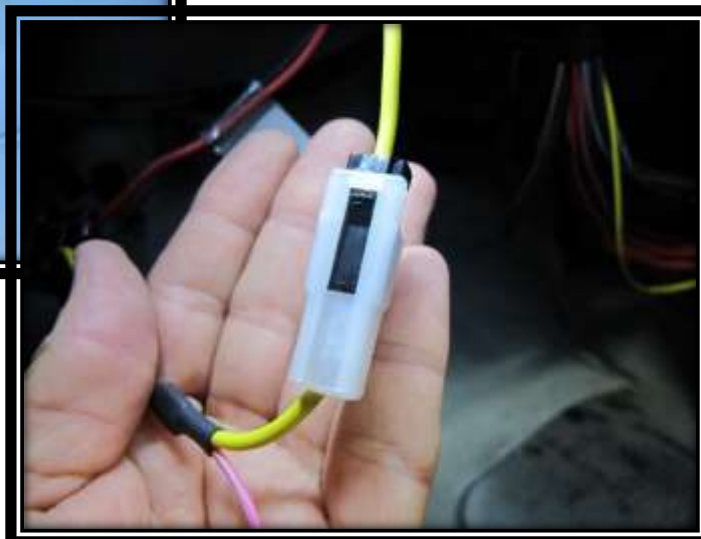
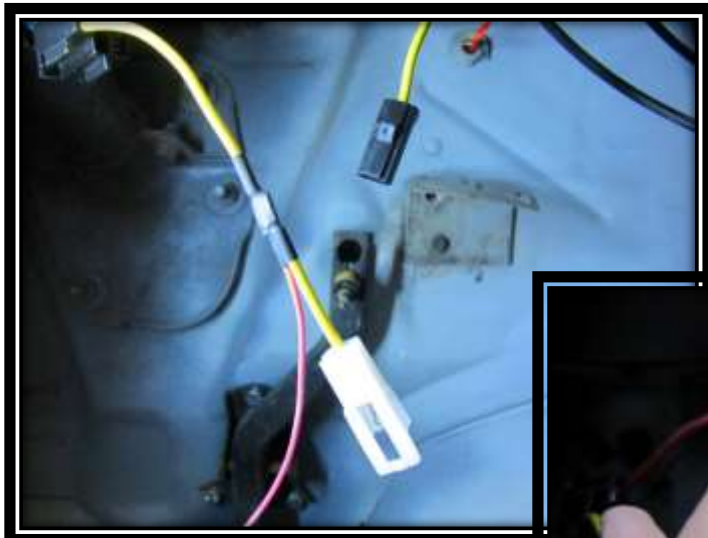

Step 40: Recouple the connector to the ignition switch.



Step 41: Locate the **weather-pack connector** on the harness and remove the cap to expose the male connector.



Step 42: Connect the pink wire from the **ignition pigtail** to the **weather-pack connector**, secure the wires up out of the way with a provided **zip-tie**. This completes the installation of your new Trail Rocker Kit.

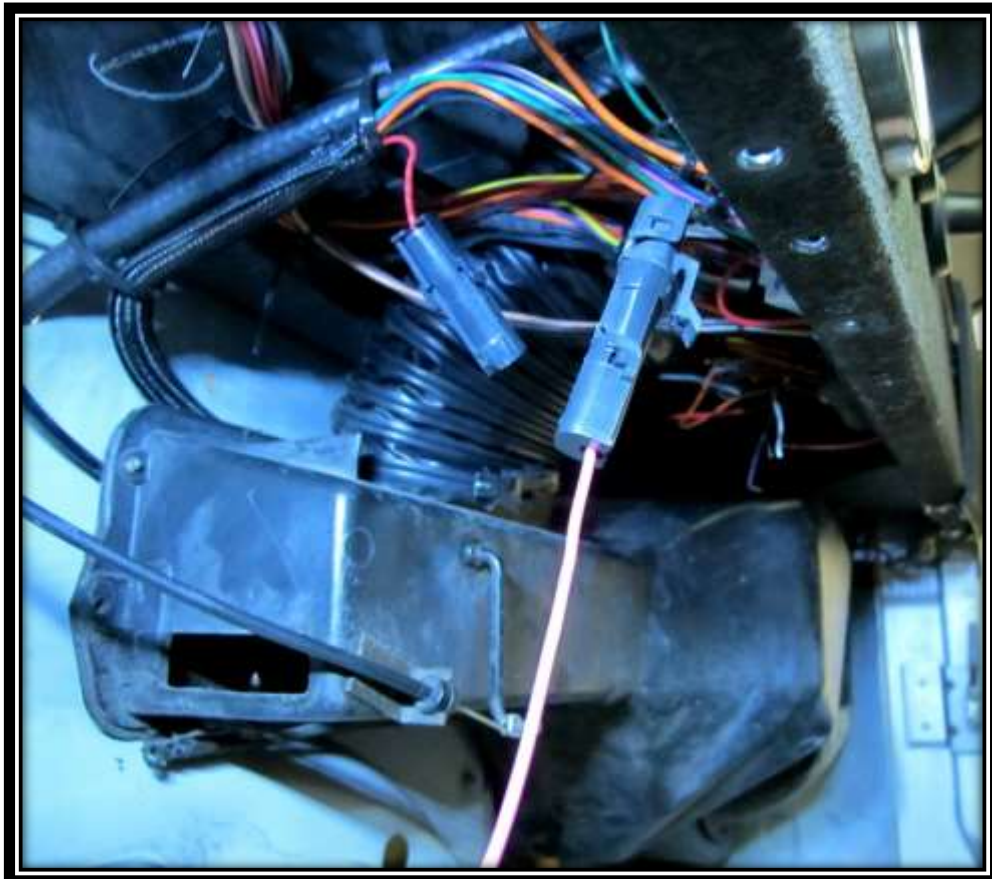
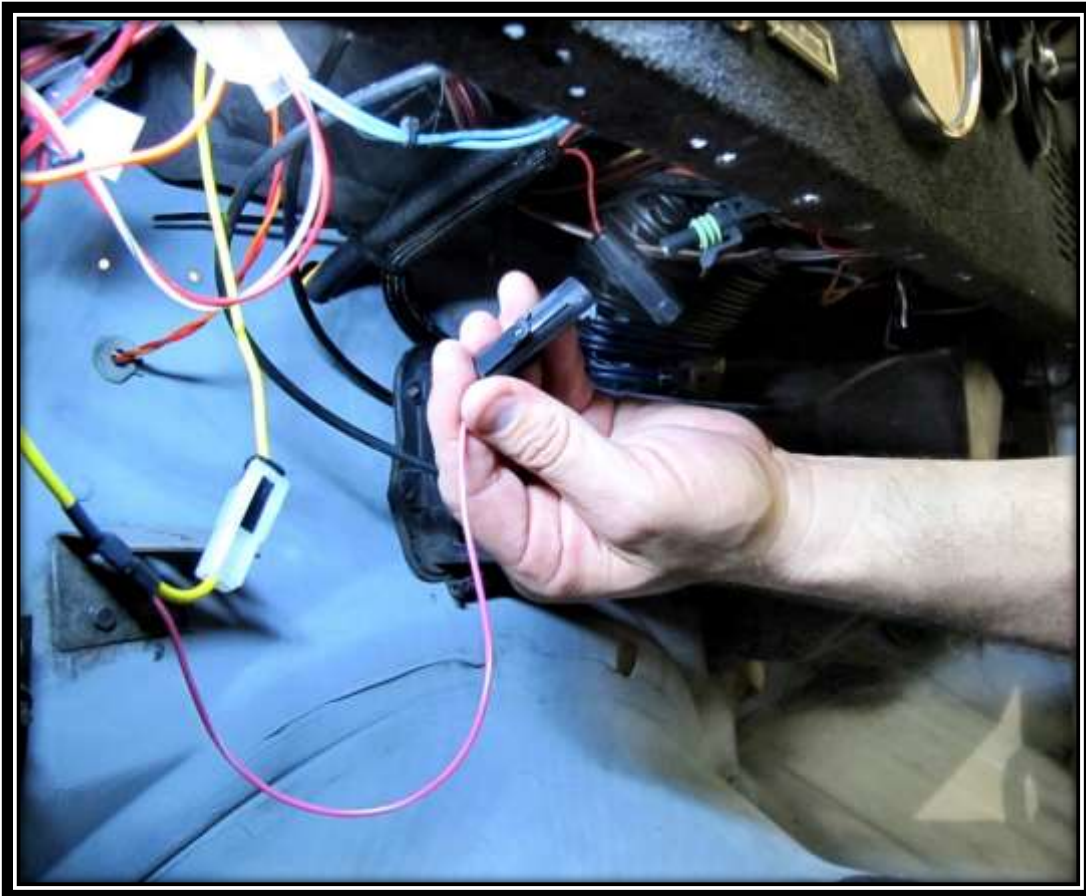

RELAY OUTPUT WIRES

Step 43: Locate the Relay Output wires.



Step 44: Rout the Relay Output wires through the grill and in front of the radiator.

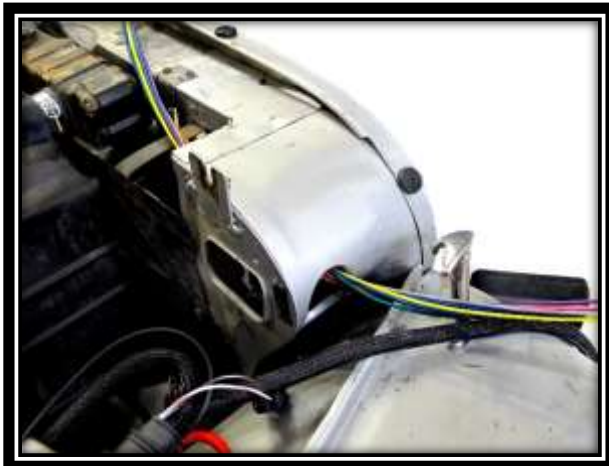

Step 45: Continue to run the Relay Output wires along the radiator and through the other side of the grill.

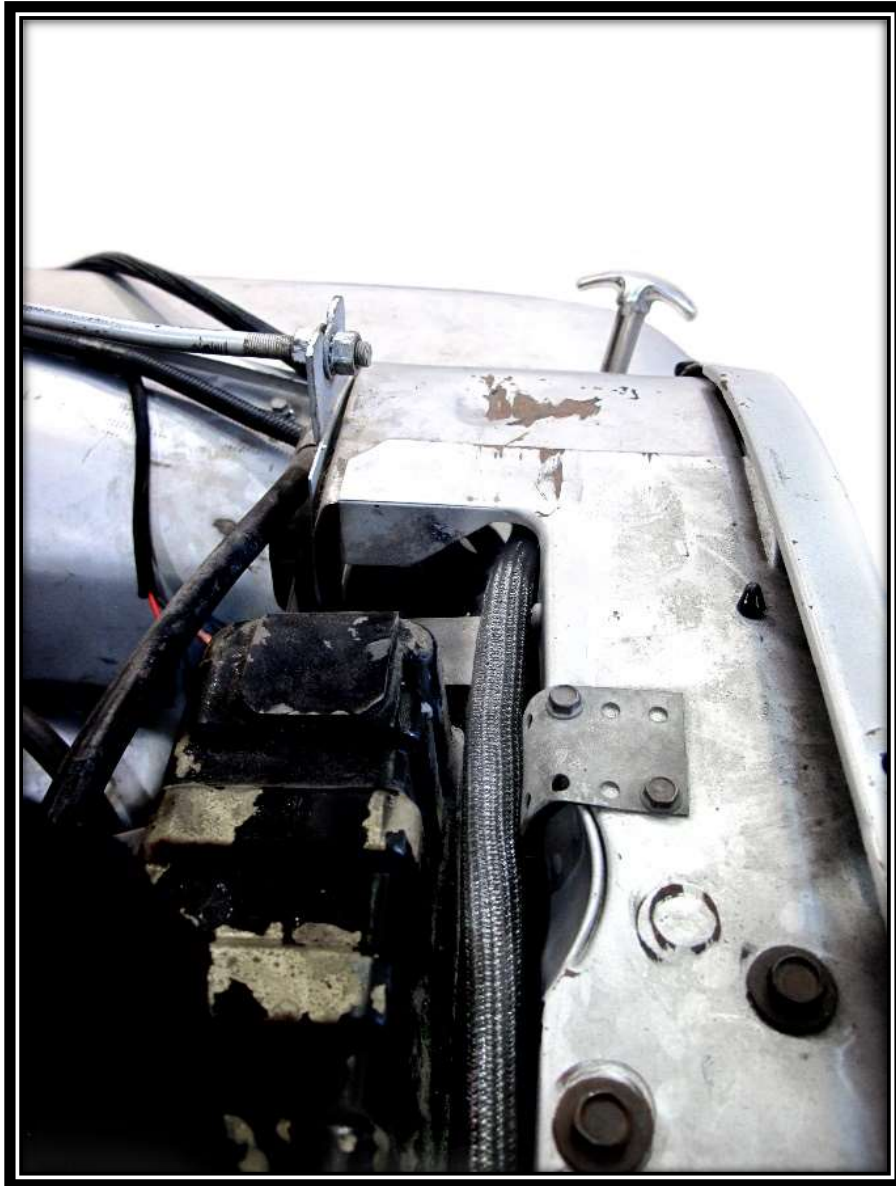

Step 46: Locate the 2 support brackets running from the grill to the fan shroud and remove the screws attaching them to the grill.

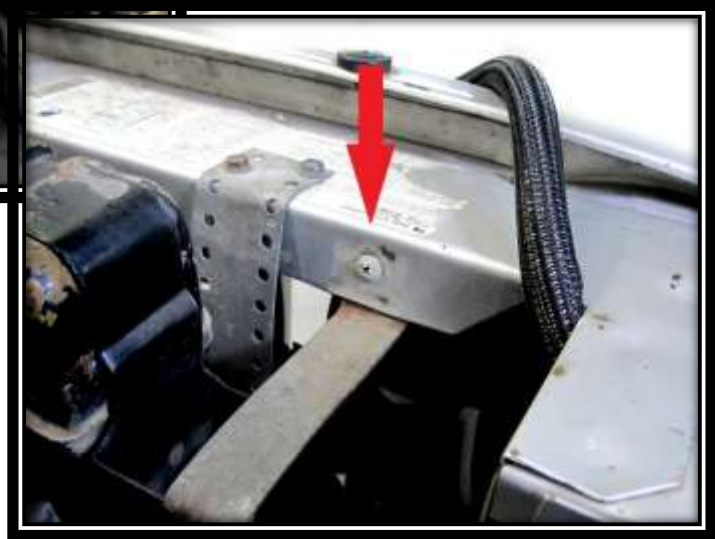
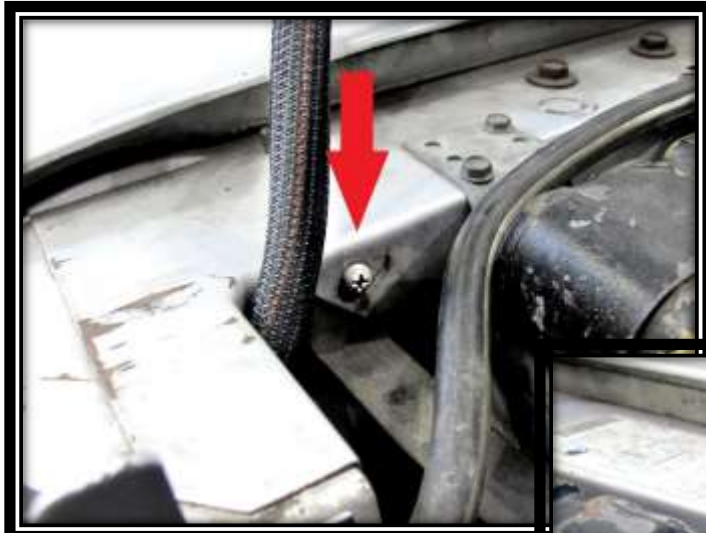

Step 47: Locate (2) ¾" Adel clamps from the included parts kit. Slide the clamps over the **Relay Output** wires and attach them to the grill using the screws you removed in the previous step.



Step 48: Route the remainder of the bundle back toward the firewall, and zip-tie it to the factory wiring. Then, zip-tie and stow away any unused wires as neatly as possible.

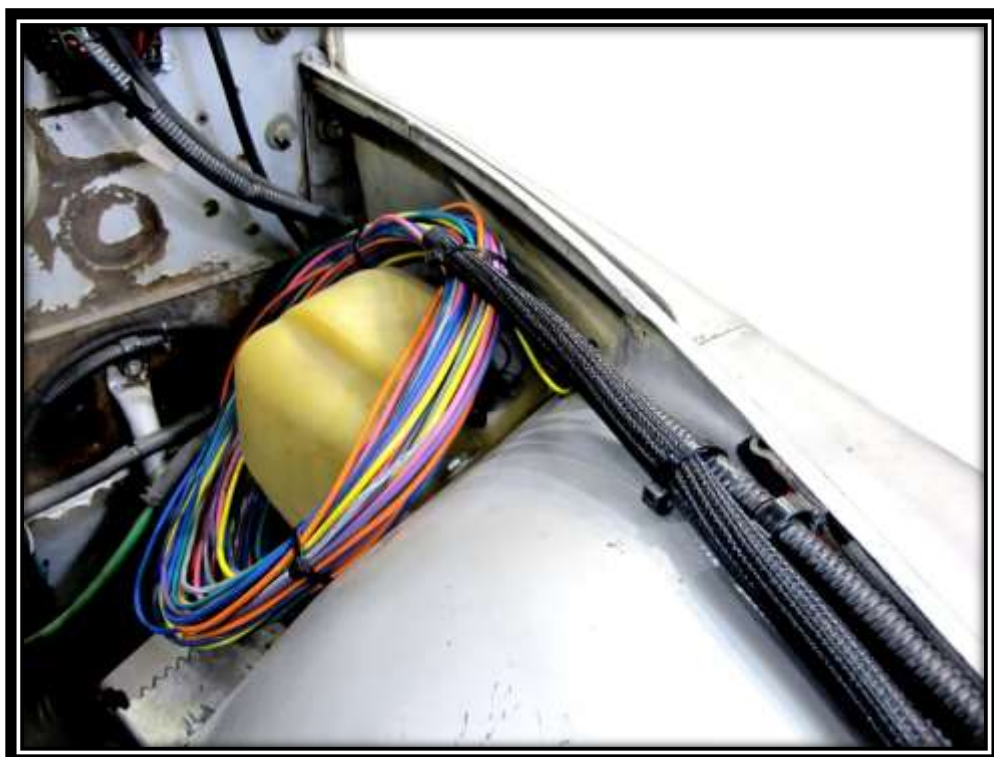
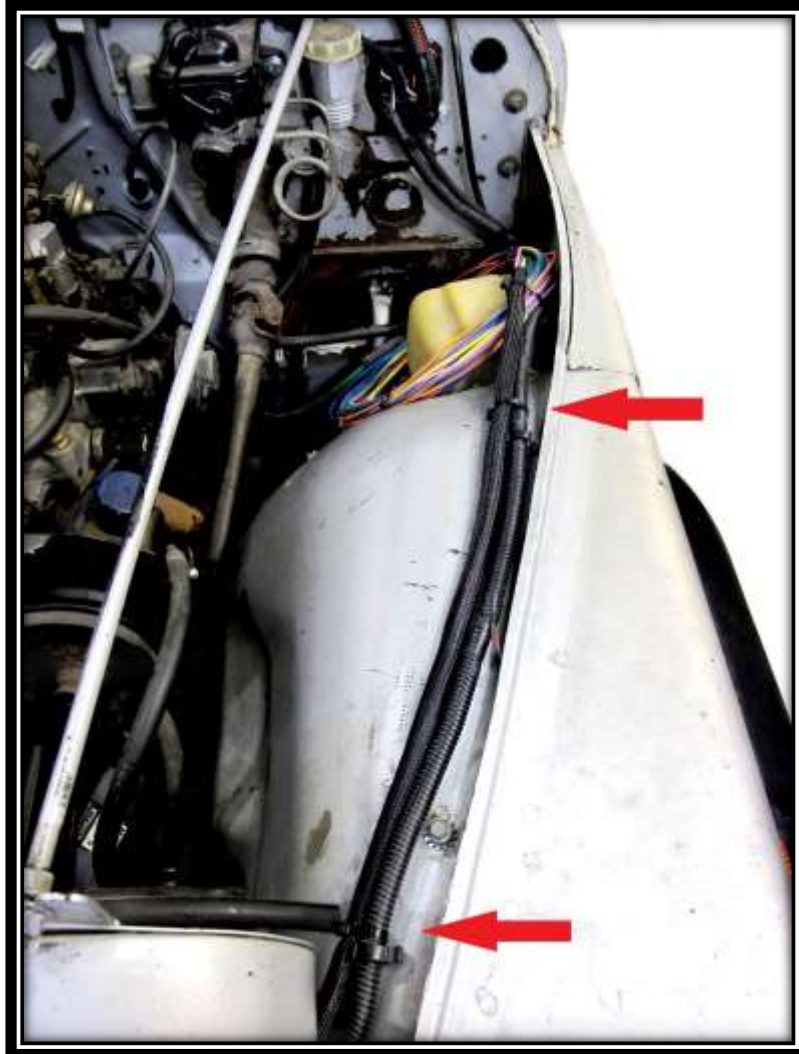

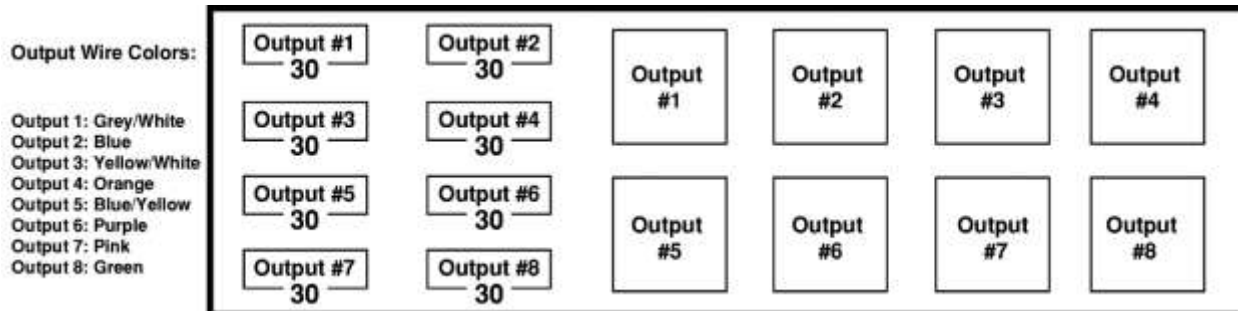

Route these wires to the location of your components. Ensure to route them safely, and avoid high heat areas, moving parts, and sharp edges. Painless recommends using grommets for any wires passing through metal to avoid wearing through the wire insulation and causing arcing. Make sure any accessories and/or components you install are properly grounded.

See **Steps 49-52** starting on [page 45](#) for a common example on connecting the **Relay Output wires** to most accessories.

Relay Output Wire Color Diagram:

- Switch #1: Grey/White
- Switch #2: Blue
- Switch #3: Yellow/White
- Switch #4: Orange
- Switch #5: Blue/Yellow
- Switch #6: Purple
- Switch #7: Pink
- Switch #8: Green

Winch Control wires:

- Winch Control In: White/Red
- Winch Control Out: Brown/White

OPTIONAL: If you wish to double the **Switch Panel wires** on a single switch, thus allowing you to control two accessories with one switch, then see **Steps 30-33** for a step-by-step tutorial on achieving this. For winch switch installation, see [page 47](#).

Step 49: Locate the **Relay Output wire** you wish to use. Then, locate the **input wire** on the accessory you are installing. Double up the accessory's input wire if necessary.

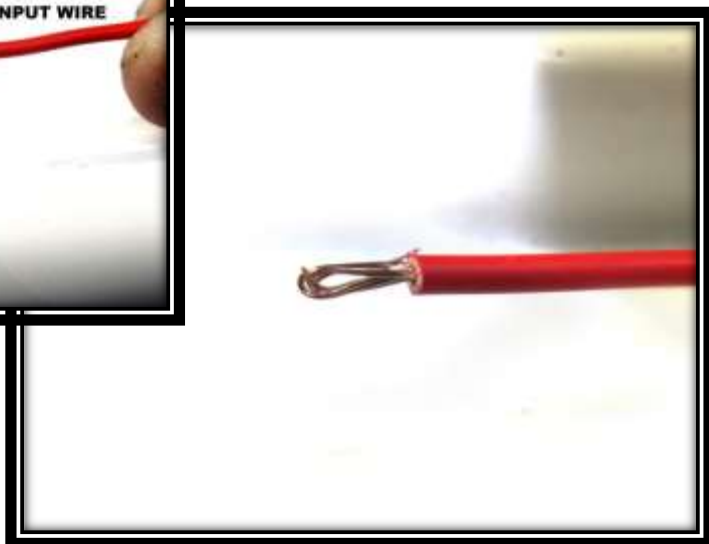
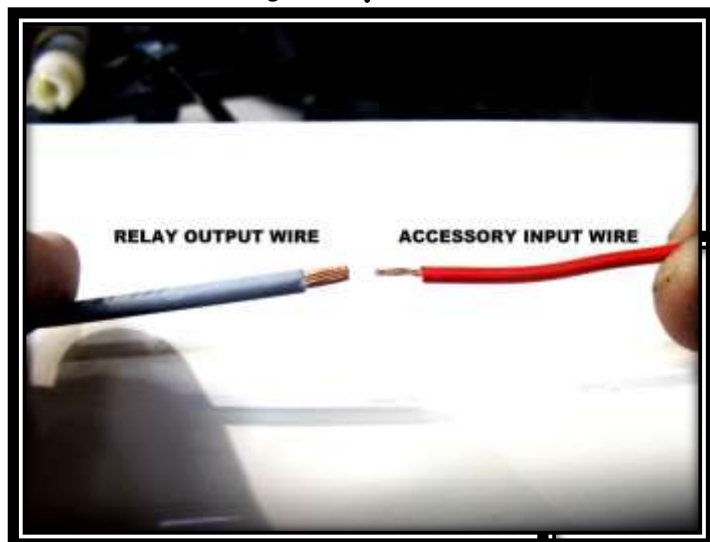

Step 50: Slide a piece of **heat shrink** from the included part kit over the **accessory wire**. Then, use an **un-insulated butt connector** to crimp together the accessory wire with the **Relay Output wire**.

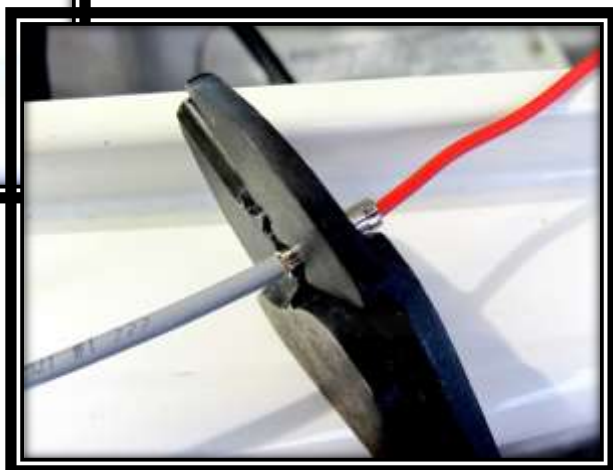

Step 51: Secure the **heat shrink** over the connection.

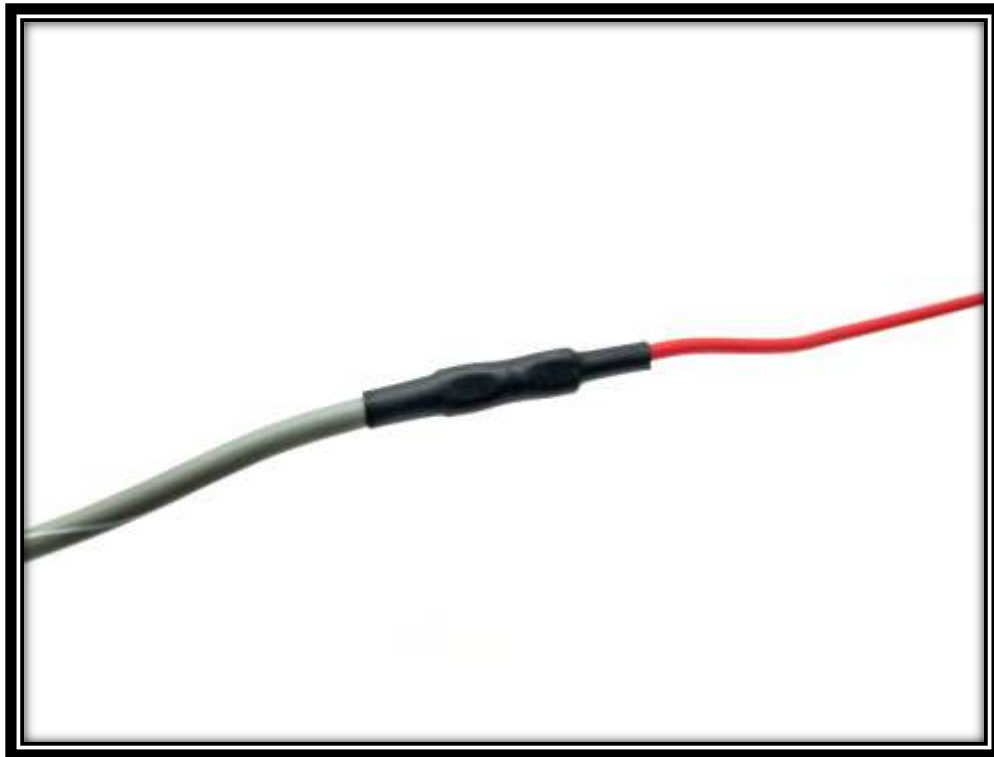

Step 52: Cap all unused Relay Output wires by crimping on the provided **insulated wire caps**. Then store the extra wires out of the way in the most convenient way possible.

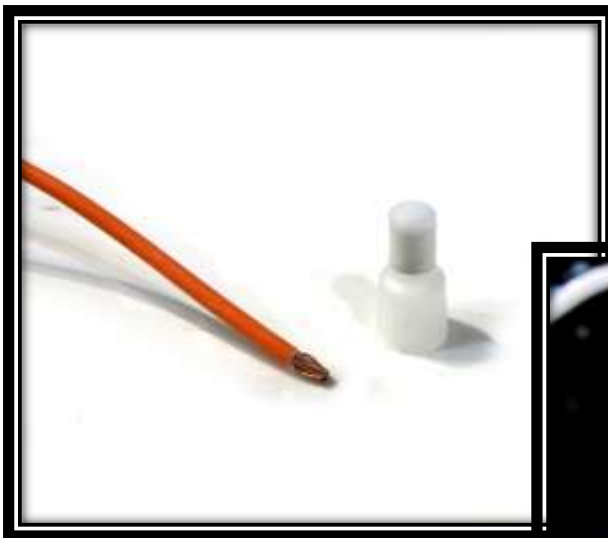

OPTIONAL: PAINLESS PART#: 57150 - WINCH

CONTROL ADD-ON KIT

As part of your **Switch Panel wiring harness**, there are 2 optional winch control wires: a **WHITE/RED (IN)** and a **BROWN/WHITE (OUT)**. These wires control the in and out functions of a winch when it is installed.



These control wires can be connected to a winch switch (not provided in the kit). If you do not have a winch switch, Painless offers a **Winch Control Add-on Kit** ([Painless Part #: 57150](http://www.painlessperformance.com), available online at www.painlessperformance.com). **Steps 53-57** show you how to install a **Winch Control Add-on Kit** to your **Trail Rocker Switch Panel** and connect the control wires to the switch.



Step 53: Remove the switch panel, power, and ground wires from the switch you are replacing with the Winch Control Add-on Kit. Then, locate the tabs located at the top and bottom of the switch.

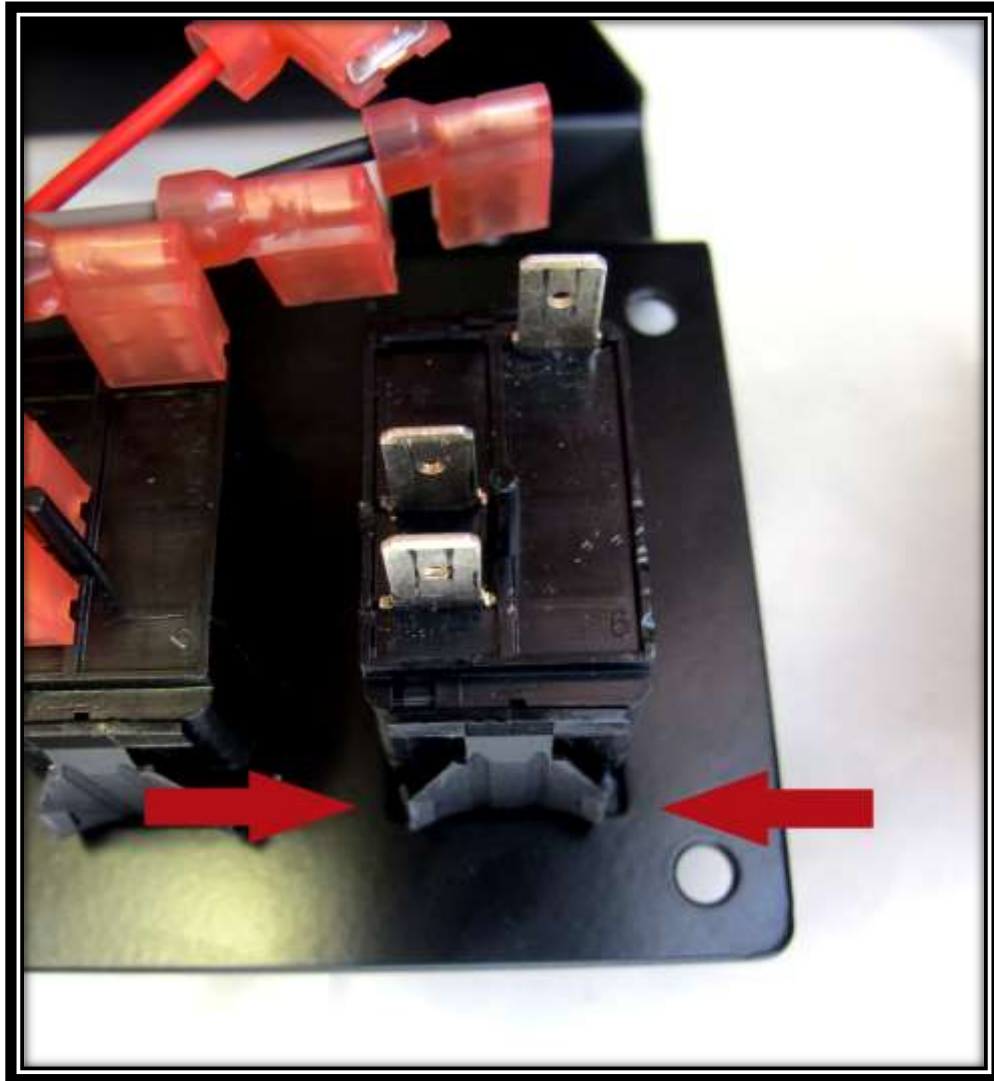

Step 54: These tabs lock the switch in place. To remove the switch, squeeze the tabs in and slide it out of the bracket.

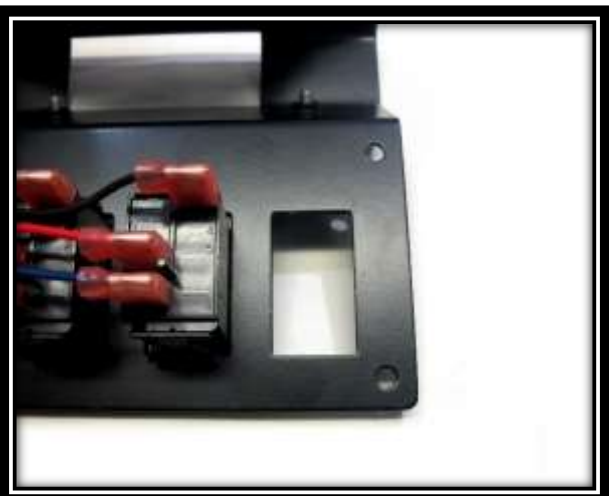

Step 55: Insert the **Winch Control Add-on Kit** into the empty socket of the bracket.

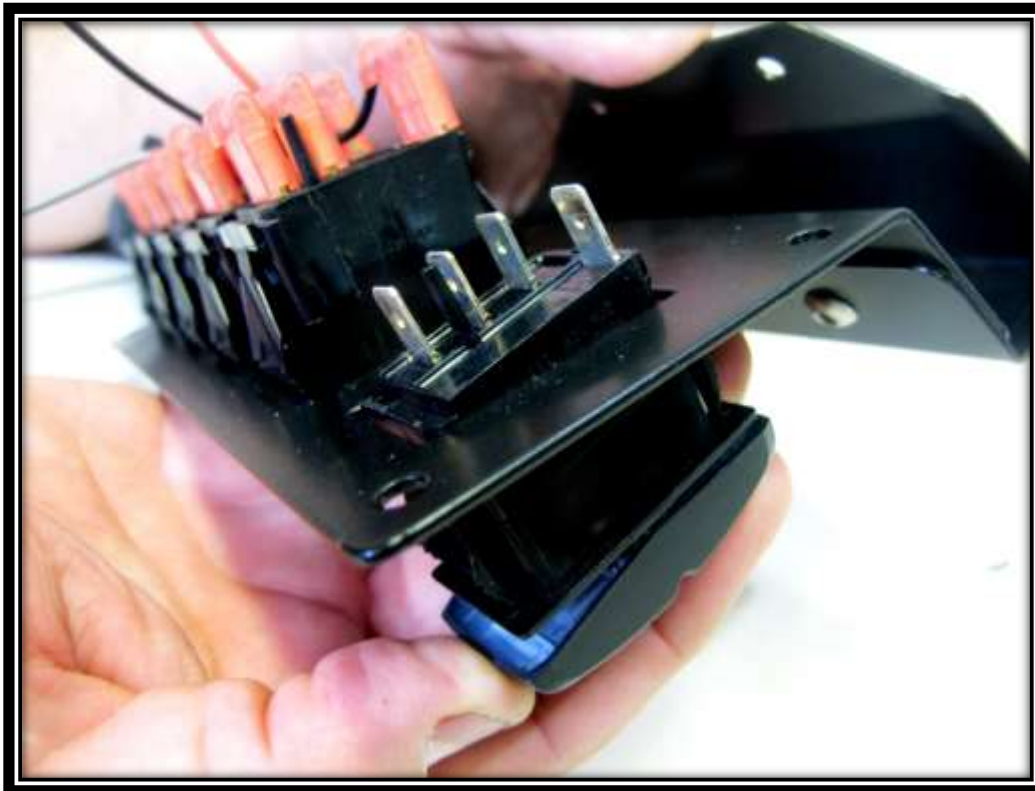

Step 56: Before connecting the wires to the Winch Control Add-on Kit, take time to familiarize yourself with the wiring diagram below.

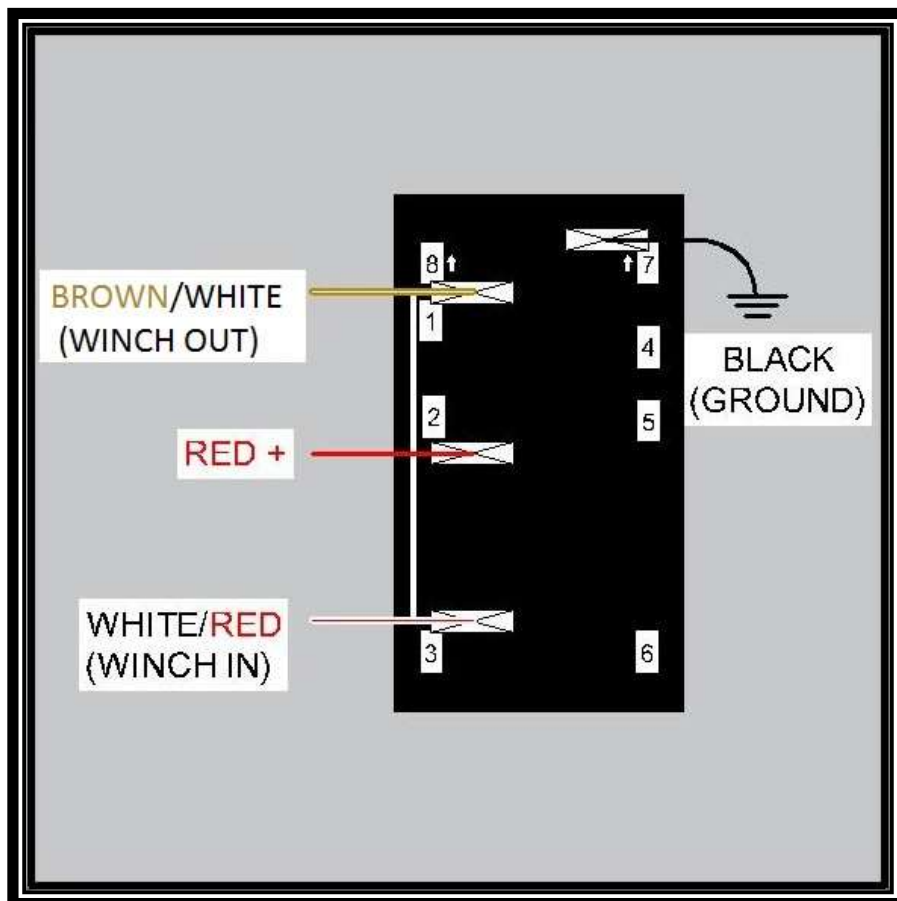

Step 57: Reconnect the power, ground, and Switch Panel wires to the Winch Control Add-on Kit as seen below.

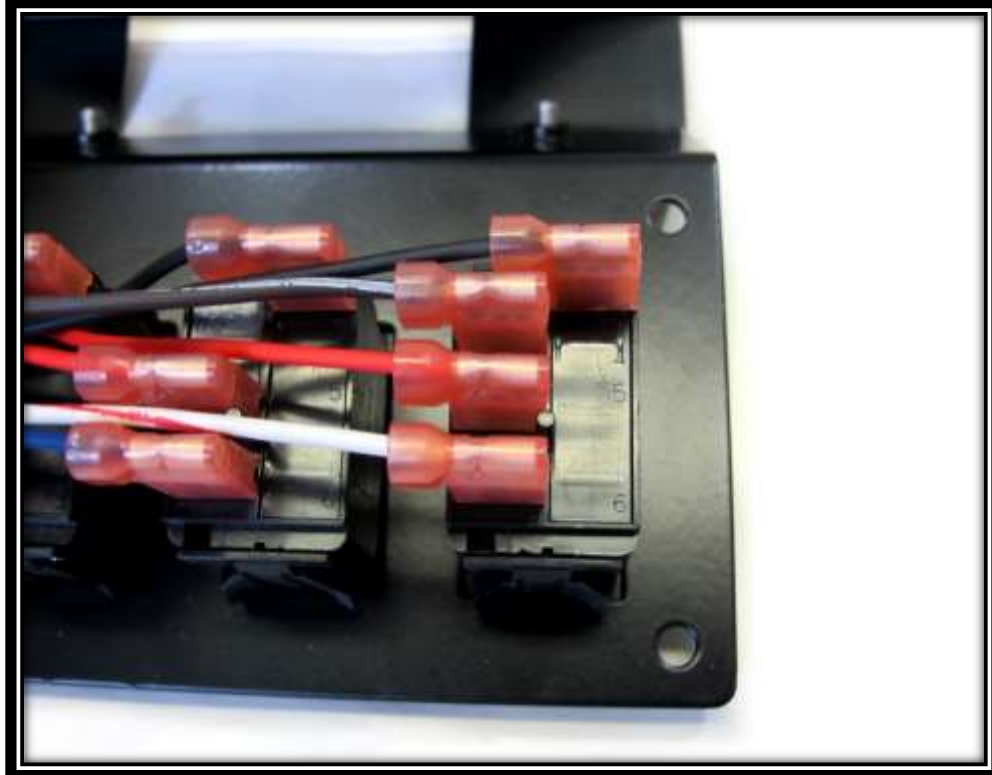
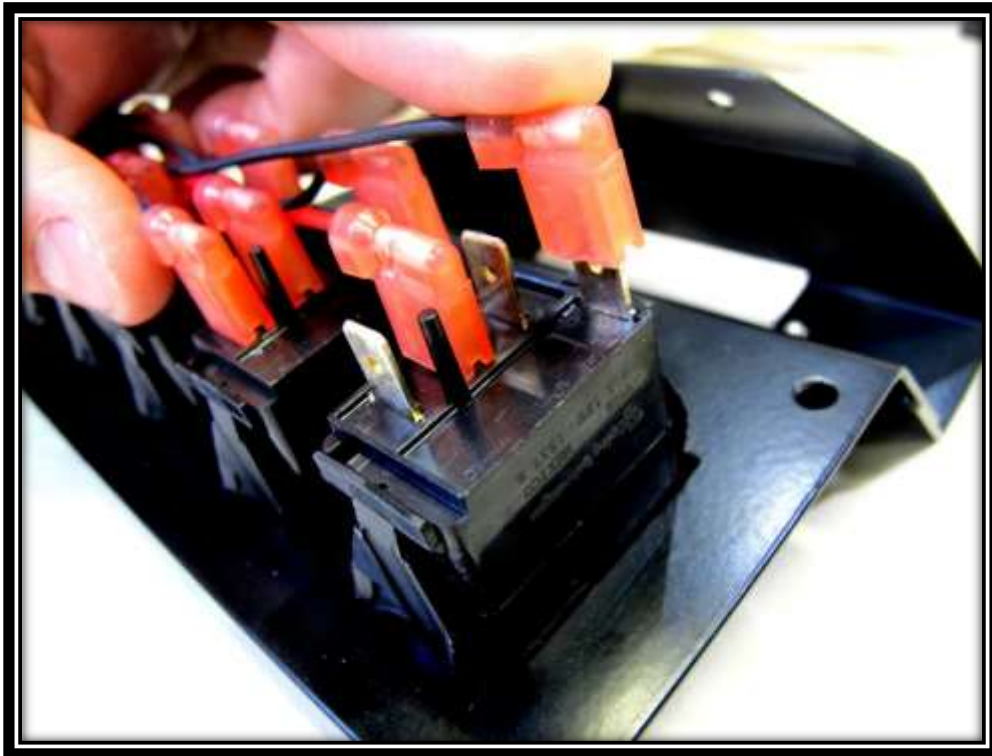

OPTIONAL: WINCH PIGTAIL

If you are hooking up your winch to your Trail Rocker System, read the following steps for attaching the included winch pigtail.

Step 58: Locate the **winch pigtail** included in your parts kit. Then locate the winch connector on your Fuse/Relay Center.



Step 59: Remove the cap from the winch connector on the Fuse/Relay Center. Then plug in the **winch pigtail** and route the wires safely to your winch.



Wiring diagrams for specific winch set-ups can be found at <http://www.painlessperformance.com/schematics> under the Trail Rocker section.

FINAL STEPS

Step 60: Reinstall the battery. Then, locate the **6-gauge, unterminated, red cable** coming from the **Fuse/Relay Center, heat shrink**, and the appropriate sized (for your particular application) **non-insulated ring terminal**.



Step 61: Notice that the **6-gauge red cable** does not have an eyelet on one end. This is so you can cut the cable to the length you need for your specific application. Mark the length you need to route the cable to the positive terminal. Cut and strip the wire about **1/2"**.



Step 62: Once the cable is stripped, remove it from the **Fuse/Relay Center** in order to crimp on the included **ring terminal** from your parts kit. To remove the cable lift up the fuse cover on the **Fuse/Relay Center bracket**. Then, remove the **2 nuts** and **200-amp MIDI fuse** holding the cable in place.

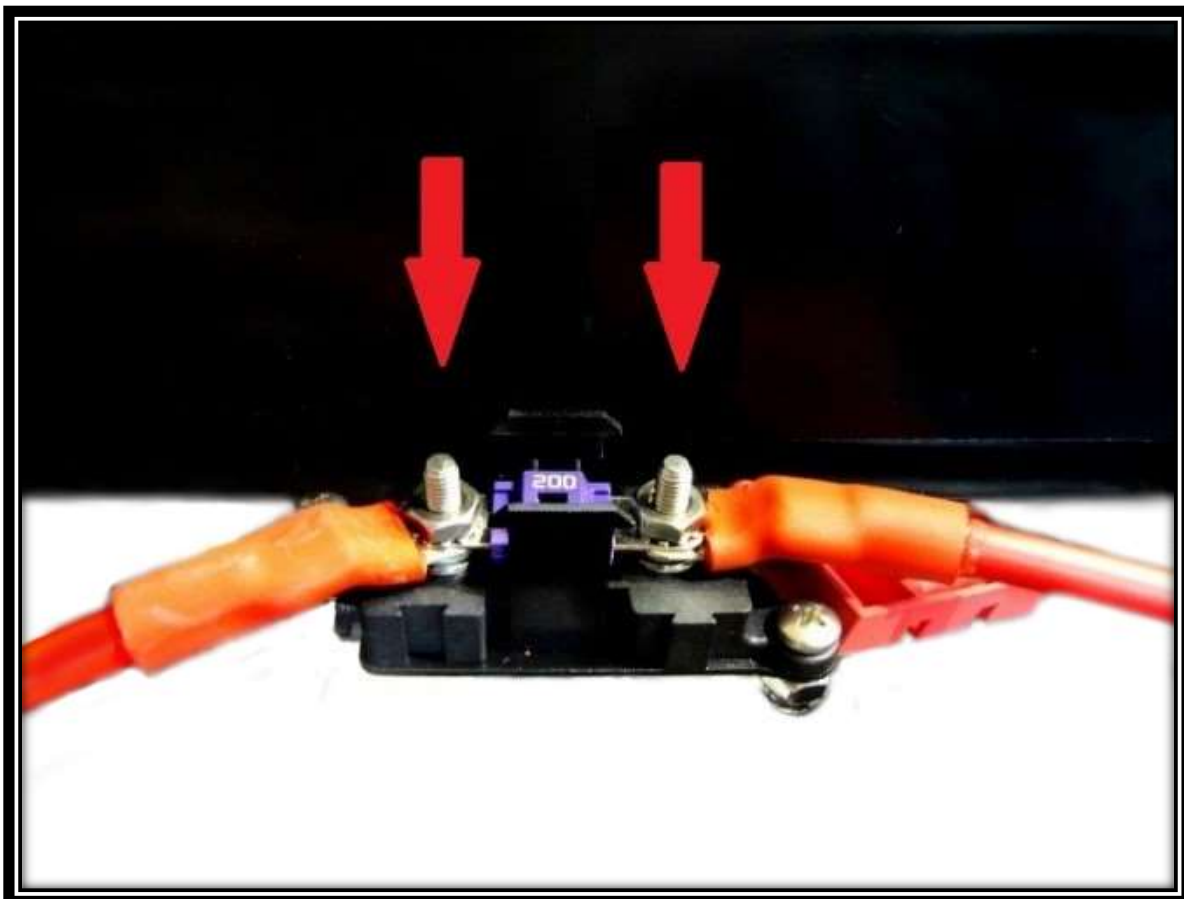

Step 63: These **ring terminals** can be difficult to crimp. It can be done with a chisel and hammer or with a crimping tool like the one below. These crimping tools can be found at your local parts store or online. Once the terminal is crimped, secure it with about **1" of heat shrink**.



Step 64: Next, re-install the cable and **200-amp MIDI fuse** to the **Fuse/Relay Center** and connect it to the positive battery terminal. Then, route the ground wire coming from the **Fuse/Relay Center** to the negative battery terminal.

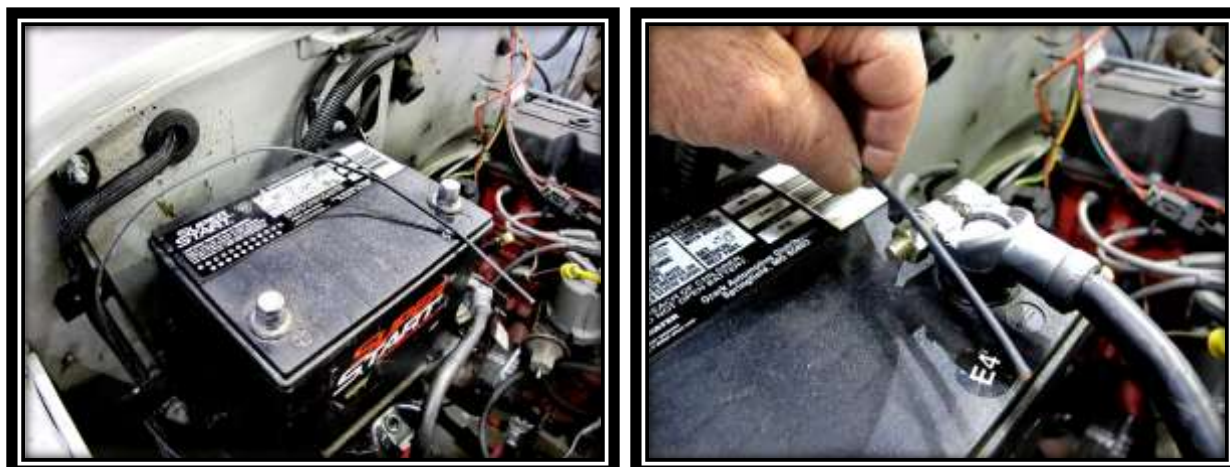

Step 65: Locate (1) ¼” black heat shrink and (1) 16-14 ga. non-insulated ring terminal. Strip the wire about ¼” and slide the heat shrink over it.



Step 66: Crimp on the ring terminal and secure it with the heat shrink.

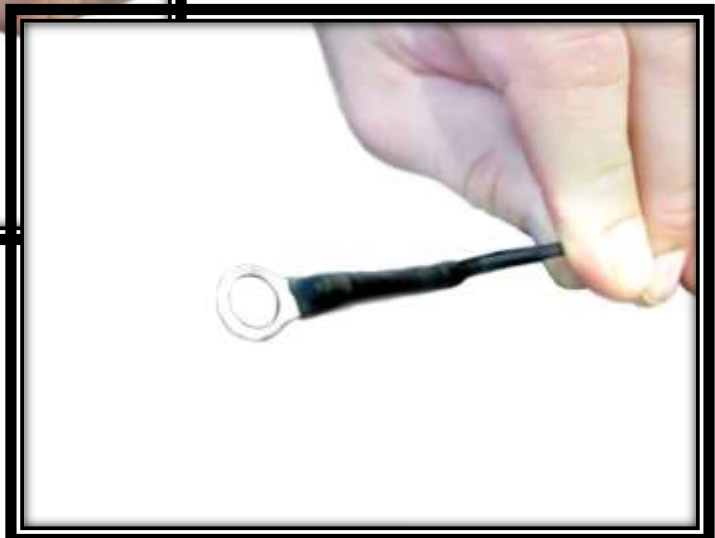

Step 67: Hook the terminals back up to your battery. Connect the red cable to the positive terminal and the ground wire to the negative terminal.



With the battery connected, you can now test out and enjoy your new Trail Rocker!

FUSE PLACEMENT

As seen in the Final Steps section the **200 amp midi fuse** is located on the fuse block on the side of the **Fuse/Relay Center** mounting bracket.

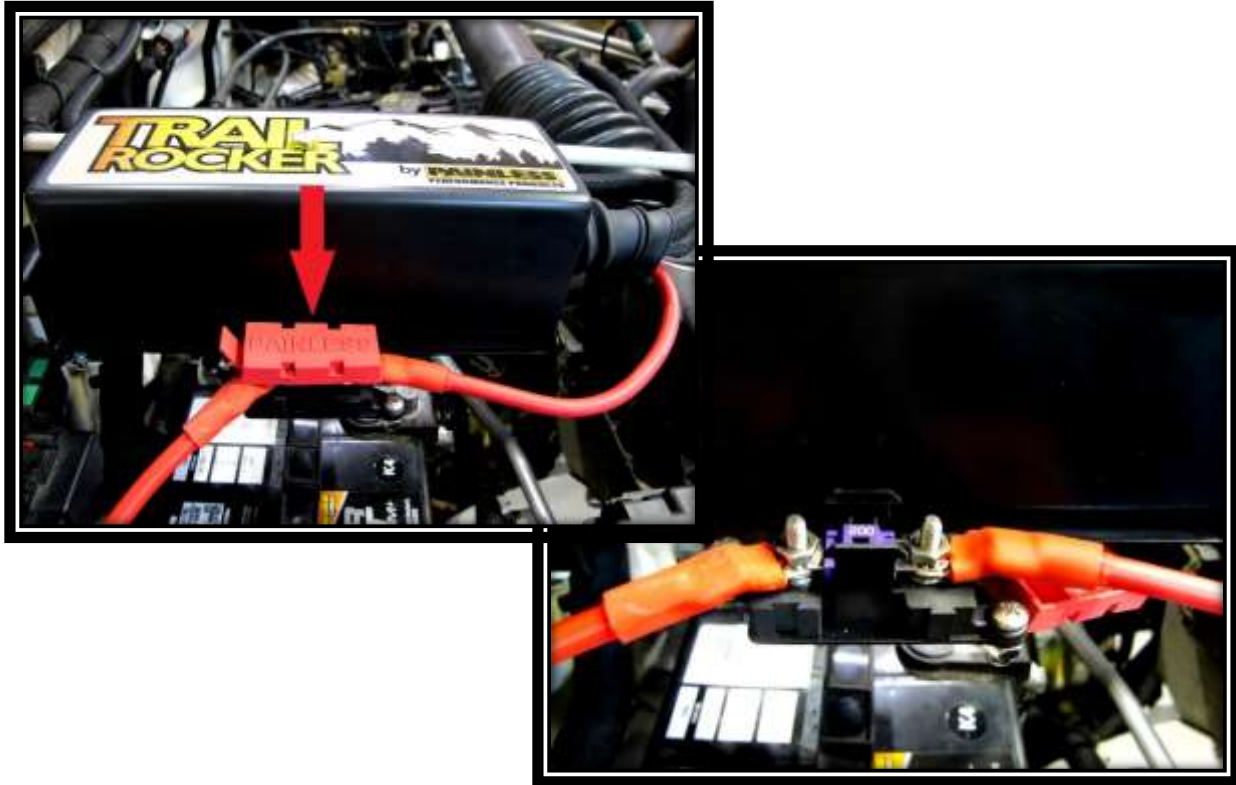

The **Fuse/Relay Center** contains eight **30 amp ATO fuses**, and can be accessed by removing the lid from the **Fuse/Relay Center**.



Trail Rocker Fuse Centers are equipped with 8 Indicator Fuses. These fuses are equipped with an LED light that will turn on when the fuse is blown, thus indicating when the fuse needs to be replaced.



Painless Performance Limited Warranty **and Return Policy**

Chassis harnesses, fuel injection harnesses, and Trail Rocker units are covered under a lifetime warranty.

All other products manufactured and/or sold by Painless Performance are warranted to the original purchaser to be free from defects in material and workmanship under normal use. Painless Performance will repair or replace defective products without charge during the first 12 months from the purchase date. No products will be considered for warranty without a copy of the purchase receipt showing the sellers name, address and date of purchase. You must return the product to the dealer you purchased it from to initiate warranty procedures.

Painless Performance Products LLC
2501 Ludelle Street
Fort Worth, TX 76105
Phone (817) 244-6212