



## *Installation Instructions*

### *Rock Crawler Roof Rack*

*(Part # 76716)*

*07-Up Jeep Wrangler J/K 2Door*

**For Technical Support/Warranty Information please call 310-762-9944**

---

**Smittybilt, 400 West Artesia Blvd, Compton, CA 90220**

**PARTS LIST:**

1	Driver Front Leg	(A)	6	Peel & Stick Foam Gaskets for Front Legs and Short Rear Mounting Brackets
1	Passenger Front Leg	(B)	6	12mm Rubber Plug/Grommets
1	Driver Rear Top Leg	(C)	4	12-1.75mm x 35mm Hex Head Bolts
1	Passenger Rear Top Leg	(D)	4	12mm ID x 32mm OD x 3mm Flat Washers
1	Driver Rear Bottom Leg	(E)	4	12mm Lock Washers
1	Passenger Rear Bottom Leg	(F)	4	10-1.50mm x 35mm Hex Head Bolts
2	Short Rear Mounting Bracket (optional drill mount)	(G)	4	10mm ID x 27mm OD x 3mm Flat Washers
2	Metal Plates (optional drill mount)	(H)	4	10mm Lock Washers
6	Knobs with 8mm Nylon Locking Hex Nut	(I)	6	8-1.25mm x 70mm Allen Bolts ( <b>for Cross Rail use only</b> )
1	Front Cross Bar / Light Bar	(J)	10	8-1.25mm x 65mm Allen Bolts
1	Rear Cross Bar / Light Bar	(K)	12	8-1.25 x 35mm Hex Bolts Grade 10.9
1	Front Basket Holder Cross Rail (Short)	(L)	8	8mm x 24mm OD x 2mm Thick Flat Washers
1	Front-Center Basket Holder Cross Rail (Mid Length)	(L)	40	8mm x 16mm OD x 1.6mm Flat Washers
1	Rear Basket Holder Cross Rail (Long)	(L)	8	8mm Lock Washers
2	Side Rails	(M)	14	8mm Nylon Lock Nuts
2	12mm Double Nut Plates	(N)	2	ST # 5 x 30mm Sheetmetal Screw
2	Rubber Bumpers		2	ST 9.8mm OD x 5.4mm ID x 1.1mm Flat Washers
2	2" Plastic caps for bottom of front legs			

**CAUTION:** Recommended load rate is 350 lb. Too much weight will greatly reduce the stability of your vehicle and increase the vehicle's tendency to overturn. The manufacturer makes no representation or warranty as to the amount of weight that your vehicle can safely carry. For guidance, we recommend that you consult the vehicle manufacturer. Secure all payloads properly for safe transportation.

The Rock Crawler Roof Rack is NOT designed as a roll over roll bar.

**NOTE:** The "no drilling required, bolt-on" bottom rear leg mounts, (E & F), of your new Rock Crawler Roof Rack are designed to work with aftermarket bumpers only and are not compatible with the factory bumper.





(A)



(B)

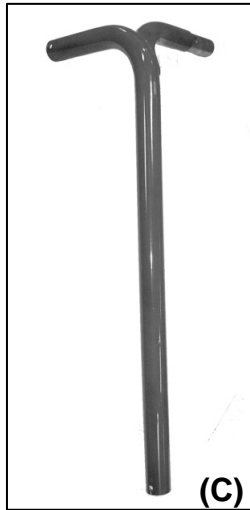

(C)

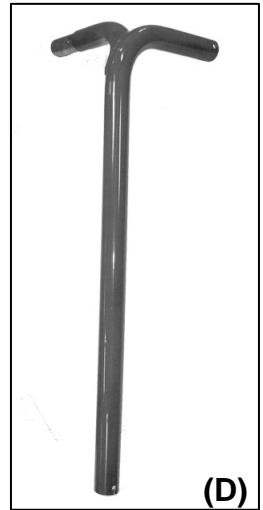

(D)



(E)



(F)



(G)

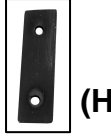

(H)

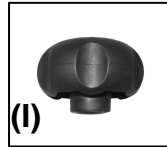

(I)

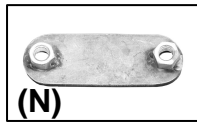

(N)

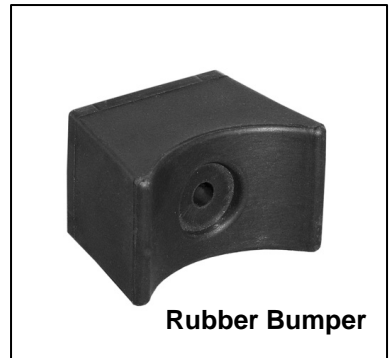

Rubber Bumper

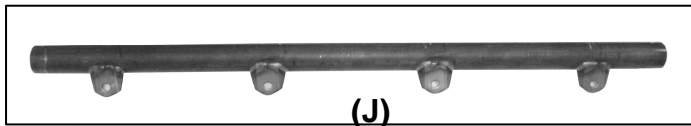

(J)

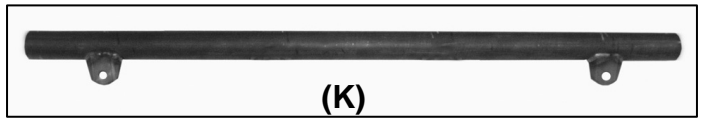

(K)

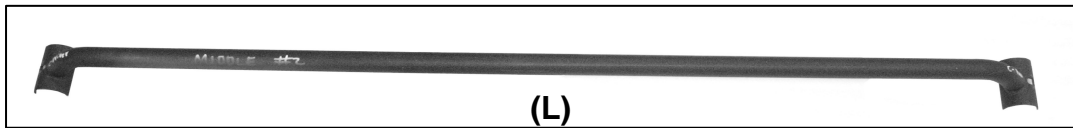

(L)

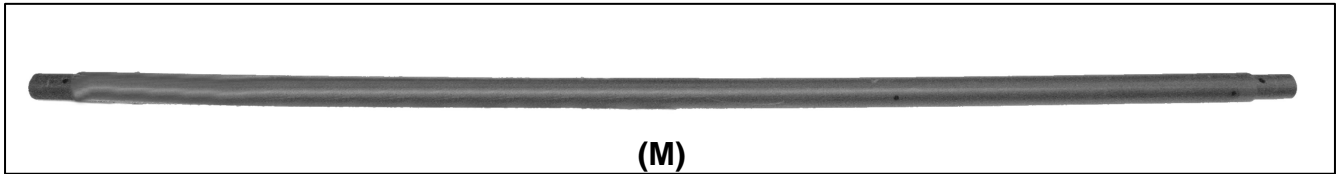

(M)

**REMOVE CONTENTS FROM BOX. VERIFY ALL PARTS ARE PRESENT. READ INSTRUCTIONS CAREFULLY BEFORE STARTING INSTALLATION. DRILLING IS OPTIONAL.**

**DO NOT TIGHTEN ANY HARDWARE UNTIL THE ROOF RACK IS FULLY ASSEMBLED.**

**DO NOT TIGHTEN HARDWARE UNTIL ASSEMBLY IS FINISHED**

**PROCEDURE:**

1. Peel, stick and trim the self sticking Foam Gaskets to the inside surface of the two mounting tabs on each Front Leg. Remove the driver side (4) factory outer windshield hinge bolts. Locate the driver side Front Leg, **(A)** and attach it to the windshield hinge using (4) 8-1.25mm x 35mm Hex Bolts, (4) 8mm Lock Washers and (4) 8mm x 24mm OD x 2mm Thick Flat Washers, **(Figure 1)**.

Apply foam tape to the back of these mounting tabs to protect vehicle's finish.

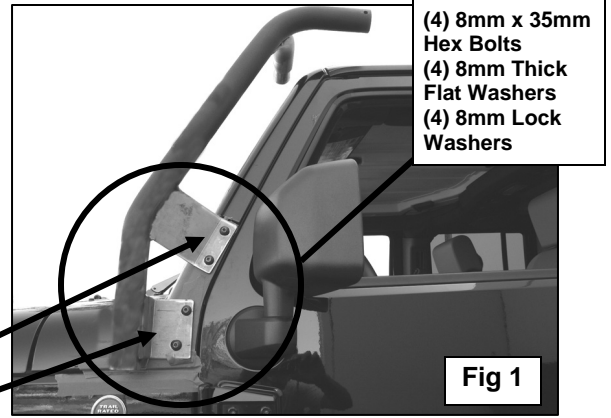

2. Slide front Cross Bar into partially installed driver side Front Leg and secure it with the included (1) 8mm x 65mm Allen Bolt, (2) 8mm Flat Washers and (1) 8mm Nylon Lock Nut, **(Figure 2)**.

Cross Bar pictured with tabs facing forward (optional). Recommended install is with tabs facing to the rear.

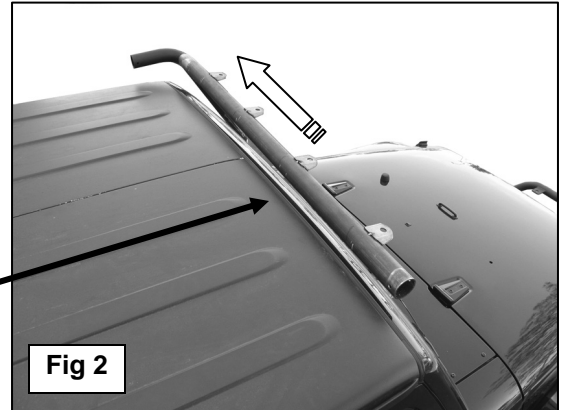

3. Remove the passenger side (4) factory outer windshield hinge bolts. Locate the passenger side Front Leg, **(B)** and apply the Foam Gasket as described in Step 1. Align the holes on the lower section of the Front Leg with holes on the windshield hinge and slide the tube into the Cross Bar. Secure the Front Leg to the vehicle using (4) 8-1.25mm x 35mm Hex Bolts, (4) 8mm Lock Washers and (4) 8mm x 24mm OD x 2mm Thick Flat Washers. Proceed to secure upper section of the Front Leg to Front Cross Bar using the included (1) 8mm x 65mm Allen Bolt, (2) 8mm Flat Washers and (1) 8mm Nylon Lock Nut, **(Figure 3)**.



4. Remove the two bolts holding the aftermarket bumper-if equipped, **(Figure 4)**.

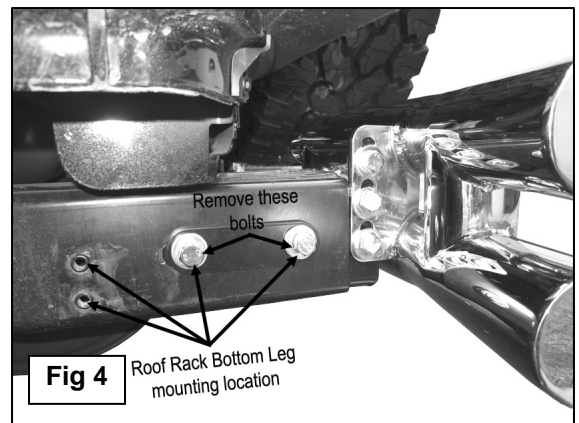

**DO NOT TIGHTEN HARDWARE UNTIL ASSEMBLY IS FINISHED**

5. **OPTIONAL:** If you decide to bolt the Roof Rack directly to the body of the vehicle, remove both taillights from vehicle at this time, **(Figure 5)**. **NOTE: Drilling required for "Bolt Direct to Body" Installation. See Figures 14-On, Steps 18-On for detailed information.**

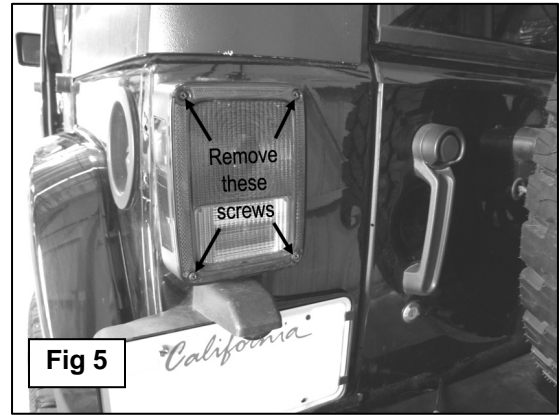

Fig 5

6. **NOTE:** Cover the ends of the Side Rails facing the rear of the vehicle with masking tape to protect the vehicle from damage during assembly. Slide both Side Rails, (with top holes angled towards the outside of the vehicle), into the previously installed Front Legs. Secure the Side Rails to the Front Legs using the included (1) 8mm x 65mm Allen Bolt, (2) 8mm Flat Washers and (1) 8mm Nylon Lock Nut, **(Figure 6)**. Do not tighten hardware.

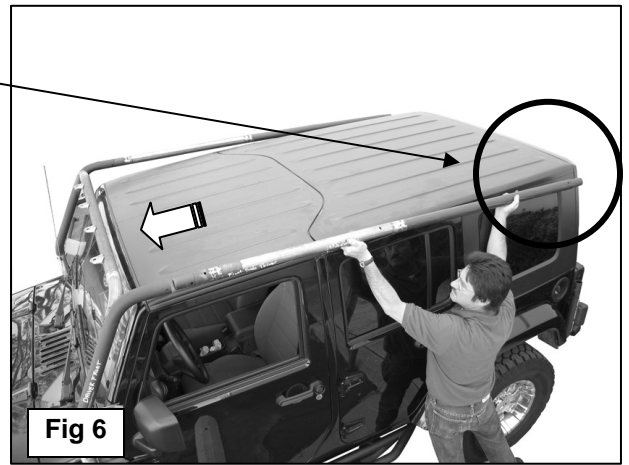

Fig 6

4-Door installation is pictured as an example. 2 and 4-Door Rock Crawler Roof Rack installation is identical

7. To better support the Roof Rack when loaded, (2) Rubber Bumpers are included in the installation kit. The Rubber Bumpers can be installed at a point 29" up from the end of the Rear Leg for vehicles with hard tops or at 6-3/8" for vehicles with hard or soft tops, **(Figure 7)**. Once the location is determined and marked, select the side of the Rear Leg (C,D) facing the vehicle and mark the location. Remove the Rear Leg. Place the Rear Leg on a stable work surface with the side to be drilled facing up. Drill an 1/8" hole into the Rear Leg. Drill only through the side requiring the Rubber Bumper. Do not drill through both sides of the tube. Secure the Rubber Bumper to the Rear Leg with (1) #5 x 30mm Screw and (1) 5mm Flat Washer. Snug but do not over tighten or the Rubber Bumper will be deformed.

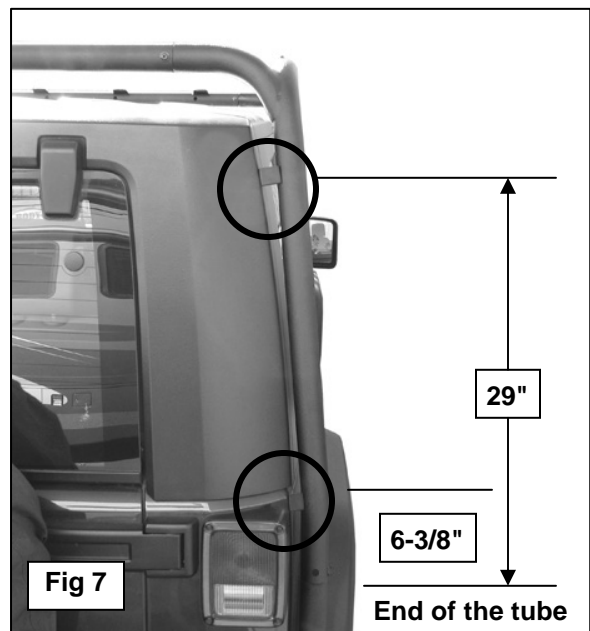

Fig 7

**DO NOT TIGHTEN HARDWARE UNTIL ASSEMBLY IS FINISHED**

8. On a clean, stable work area, assemble the rear section of the Roof Rack by attaching both Upper Rear Legs to the Rear Cross Bar. **NOTE:** The Rear Cross Bar can be installed with the light tabs facing forward (preferred) or rearward (optional). Secure this assembly by using the included (2) 8mm x 65mm Allen Bolts, (4) 8mm Flat Washers and (2) 8mm Nylon Lock Nuts, (**Figure 8**). Do not tighten hardware at this time.



9. With assistance, attach the assembled rear top section of the Roof Rack to the already inserted Side Rails. **NOTE:** Be careful not to damage the vehicle when attaching the top section. Use the included (2) 8mm x 65mm Allen Bolts, (4) 8mm Flat Washers and (2) 8mm Nylon Lock Nuts to attach the Rear Top Legs to the Side Rails, (**Figure 9 & 10**).

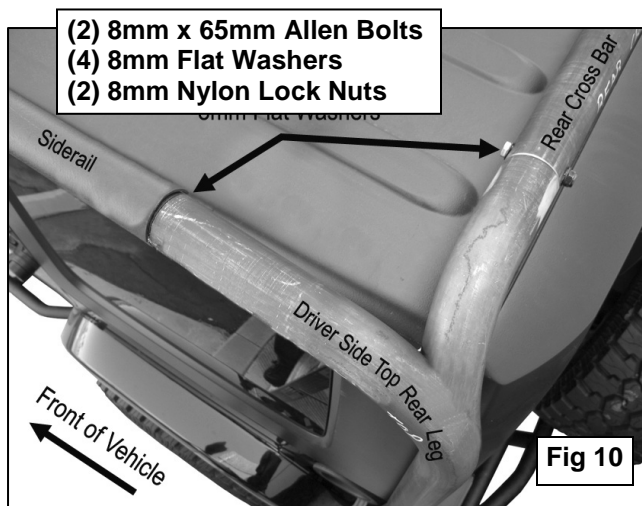
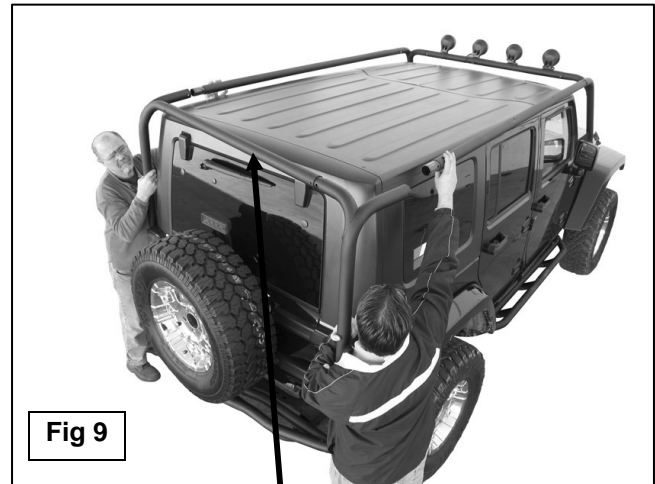

**IMPORTANT! Do not lay Roof Rack on your vehicle to attach the Rear Bottom Legs at any time. Damage to the vehicle may occur.**

4-Door installation is pictured as an example. 2 and 4-Door Rock Crawler Roof Rack installation is identical

10. For "Bolt Direct to Body" installation, proceed to Step 18.

11. With assistance, hold the rear section of the Roof Rack up and attach the Rear Bottom Leg section to the Rear Top Leg section using the included (2) 8mm x 65mm Allen Bolts, (4) 8mm Flat Washers and (2) 8mm Nylon Lock Nuts, (**Figure 11**). **IMPORTANT!** Do not lay Roof Rack on your vehicle to attach the Rear Bottom Legs at any time. Damage to the vehicle may occur.



## DO NOT TIGHTEN HARDWARE UNTIL ASSEMBLY IS FINISHED

12. Position the passenger Rear Bottom Leg up to the frame and align the holes in the Bracket with holes in the frame for the bumper. Secure the rear holes in the Mounting Bracket to the bumper using the same bolts that came with your aftermarket bumper. Attach the front of the Bracket to the frame using the factory bolts or the included hardware, **(Figure 12A & 11B)**. Repeat this step for the driver side installation.

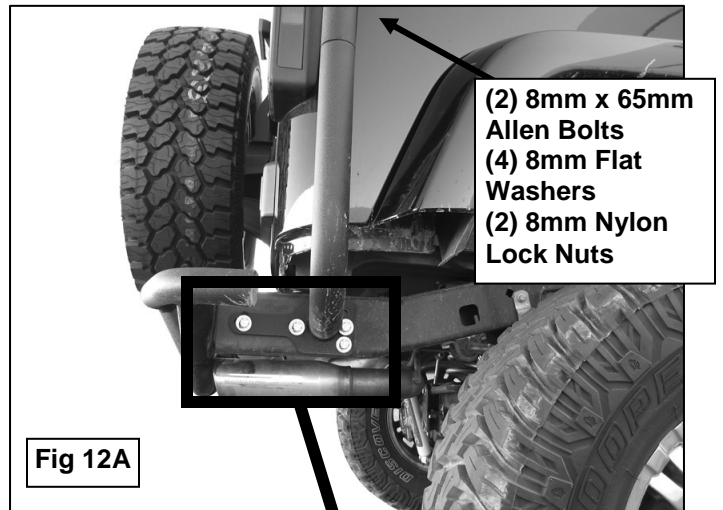

**Note:** Installation shown with aftermarket bumper. Use the included Double Nut Plate, **(N)**, inside the rectangular frame tube as required for installation on vehicles without rear bumper or aftermarket bumpers that are not threaded for mounting bolts. Also use the following hardware included with this kit as needed:

- (4) 12-1.75mm x 35mm Hex Bolts
- (4) 12mm Lock Washers
- (4) 12mm x 32mm OD x 3mm Flat Washers

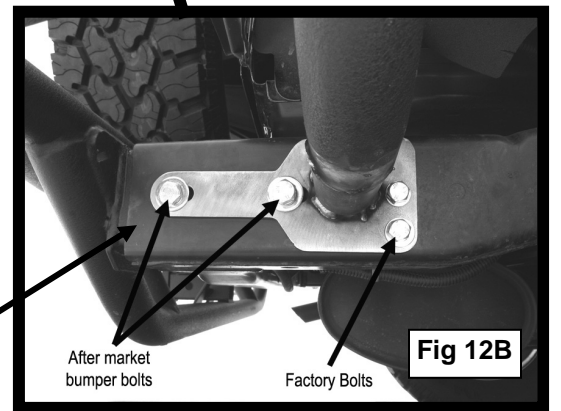
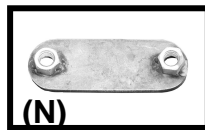

13. **NOTE:** All Basket Holder Cross Rails are different sizes with the shortest to the front, mid length to the center and the longest to the rear of the Roof Rack. Locate the shortest Cross Rail and position it over the mounting bolt holes toward the front of the Side Rails, **(Figure 13)**.

14. To secure the Basket Holder Cross Rail to Side Rails, insert (1) 8mm x 70mm Allen Bolt with (1) 8mm Flat Washer up through the bottom hole in the Side Rail and through Cross Rail. Place (1) 8mm Flat Washer over the bolt and secure it with the included Plastic Knob, **(Figure 13)**.

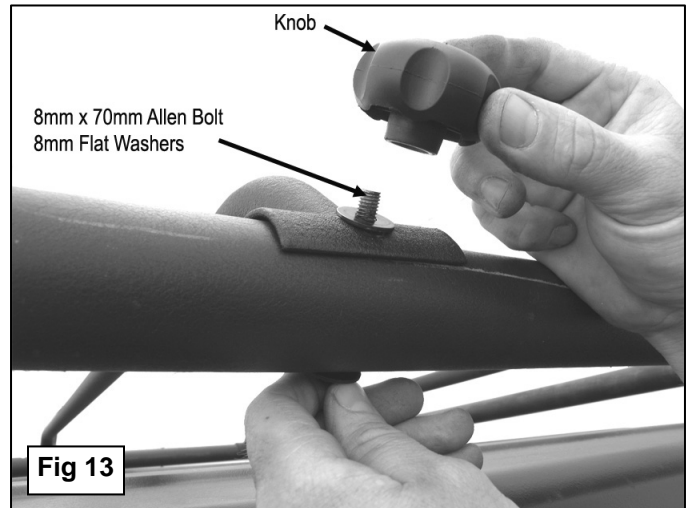

15. Repeat steps 12 and 13 for the rest of the Basket Holder Cross Rails.

16. Align Roof Rack properly then **tighten all hardware**.

17. Do periodic inspections to the installation to make sure all hardware is secure and tight.

## OPTIONAL "BOLT DIRECT TO BODY" INSTALLATION INSTRUCTIONS

18. Select the (2) Short Bottom Brackets and apply Peel and Stick Foam Gasket Material (G) to the back of the 2-hole mounting tabs. With assistance, hold the rear section of the Roof Rack up and attach the Short Bottom Bracket to the Rear Top Leg Section using the included (2) 8mm x 65mm Allen Bolts, (4) 8mm Flat Washers and (2) 8mm Nylon Lock Nuts (**Figure 14**). **IMPORTANT!** Do not lay Roof Rack on your vehicle to attach the Rear Bottom Legs at any time. Damage to the vehicle may occur.

**WARNING:** Before drilling into the vehicle, verify that all parts of the Roof Rack are completely clear of any top mechanisms, (soft and hard tops), sunroofs and factory or added accessories

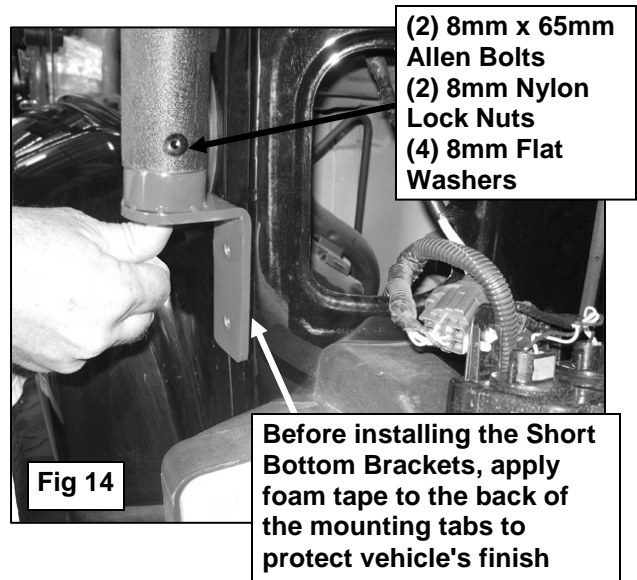

19. Align the Side Rails parallel with the roof of the vehicle, and then use the holes in the Short Bottom Bracket as a template to mark the drilling location on the vehicle, (**Figure 15**). **NOTE:** Center of the holes must be  $3/4$ " from body seam, (**Figure 16**).

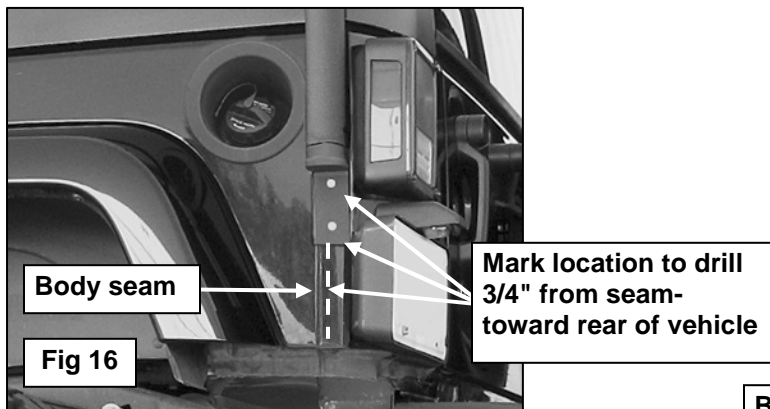
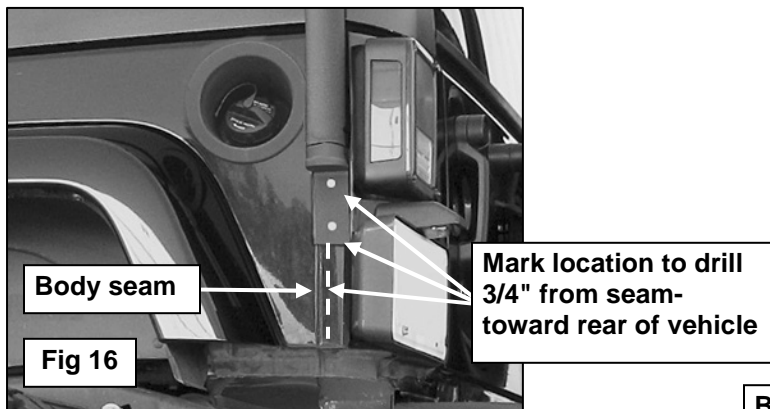

20. Once you have marked the drill locations on both sides of the vehicle, remove the rear assembly of the Roof Rack and set it aside. **NOTE:** Do not remove the Short Bottom Brackets from the Rear Legs.
21. Use a  $3/8$ " drill bit to drill out the (4) marked locations, (**Figure 17**). **IMPORTANT:** Any cutting or drilling tool may break or shatter. Government regulations require safety glasses & equipment at all times when cutting or drilling.

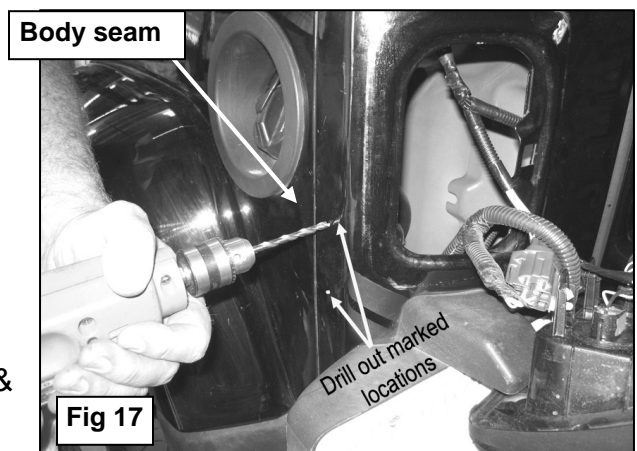



22. Starting on the driver side, place adhesive backed rubber gaskets between the body and the Short Bottom Brackets, **(Figure 18)**.
23. With assistance, re-install the rear assembly of the Roof Rack to the Side Rails. Line up the holes in the Bottom Bracket to previously drilled holes, **(Figure 18)**.

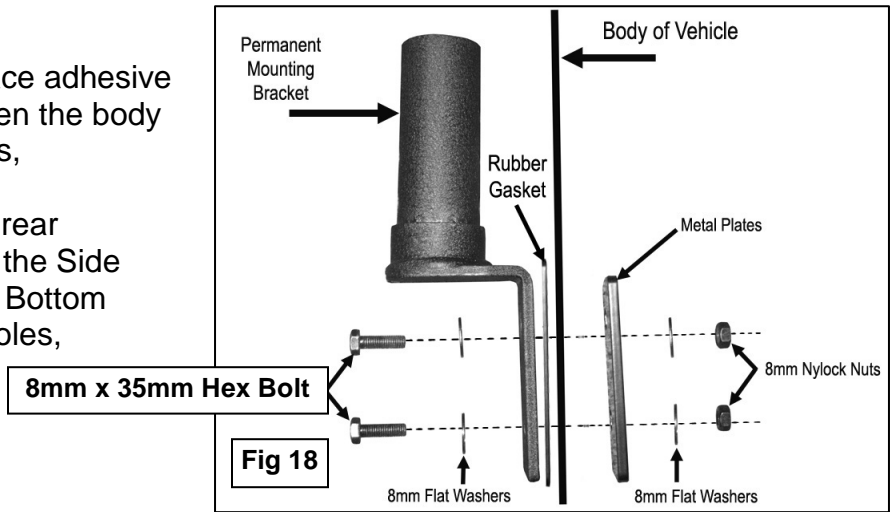

24. Insert (2) 8mm x 35mm Hex Head Bolts with (2) 8mm Flat Washers through the Short Bottom Brackets and body. Access the hardware through the opening for the taillight and position the 2-hole Metal Plates over the already inserted 8mm Hex Bolts, **(Figure 19)**.

(2) 8mm x 35mm Hex Bolts  
 (4) 8mm Flat Washers  
 (2) 8mm Nylon Lock nuts

25. Secure the Metal Plates using the included (2) 8mm Flat Washers and (2) 8mm Nylon Lock Nuts, **(Figure 19)**.
26. Repeat Steps 21-25 for the passenger side installation.

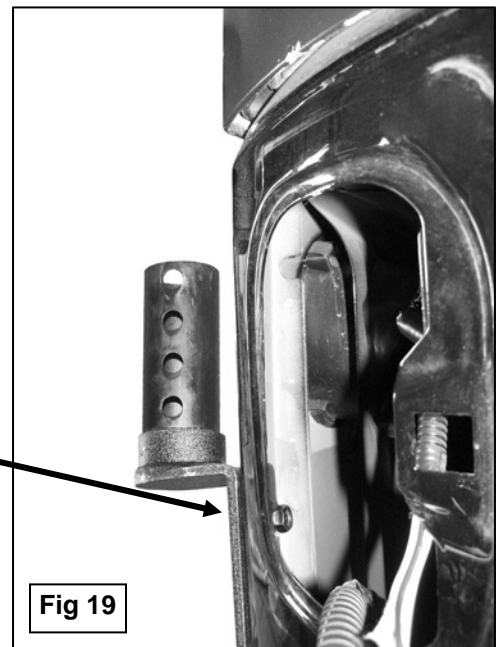

27. Go to steps 13-14 to attach the Basket Holder Cross Rails.
28. Align Roof Rack properly and **tighten all hardware**.
29. **IMPORTANT:** Do periodic inspections to the installation to make sure all hardware is secure and tight.

**To protect your investment**, wax this product after installing. Regular waxing is recommended to add a protective layer over the finish. Do not use any type of polish or wax that may contain abrasives that could damage the finish.

## LIMITED WARRANTY

Smittybilt (The Company) warrants to the original purchaser of this product that should the product or any part thereof, under normal use and conditions, be proven defective in material or workmanship within the warranty period of 5 years from the date of purchase, such defect(s) will be repaired or replaced (At the Company's option) without charge for parts or labor. To obtain repair or replacement within the terms of the warranty, the product is to be delivered with proof of warranty coverage ( e.g. dated bill of sale, receipt), specification of defect, freight pre-paid with Returns Good Authorization Number from Smittybilt to place of purchase. Items returned to Smittybilt without a Returns Authorization Number will be refused and returned to sender at the senders' expense.

This warranty does not apply to any product or part thereof which, in the opinion of the Company, has suffered or been damaged through alteration, improper installation, mishandling, misuse, neglect accident or acts of nature. **THE EXTENT OF THE COMPANY'S LIABILITY UNDER THIS WARRANTY IS LIMITED TO THE REPAIR OR REPLACEMENT PROVIDED ABOVE AND, IN NO EVENT, SHALL THE COMPANY'S LIABILITY EXCEED THE PURCHASE PRICE PAID BY THE PURCHASER FOR THIS PRODUCT.**

This warranty is in lieu of all expressed warranties and liabilities. ANY IMPLIED WARRANTIES, INCLUDING ANY IMPLIED WARRANTY OF MERCHANTABILITY SHALL BE LIMITED TO THE DURATION OF THIS WRITTEN WARRANTY. ANY ACTION FOR BREACH OF ANY WARRANTY HEREUNDER INCLUDING ANY IMPLIED WARRANTY OF MERCHANTABILITY MUST BE BROUGHT WITHIN A PERIOD OF 90 DAYS FROM DATE OF ORIGINAL PURCHASE. IN NO CASE SHALL THE COMPANY BE LIABLE FOR ANY CONSEQUENTIAL OR INCIDENTAL DAMAGES FOR BREACH OF THIS OR ANY OTHER WARRANTY, EXPRESSED OR IMPLIED, WHATSOEVER. No person or representative is authorized to assume for the company any liability other than expressed herein in connection with the sale of this product. Some states do not allow limitations on how long an implied warranty lasts or the exclusion or limitation of incidental or consequential damage, therefore above limitations may not apply to you. This warranty gives the purchaser specific legal rights. The purchaser may have additional rights, which vary from state to state.

Some states do not allow limitations on how long an implied warranty lasts or the exclusion or limitation of incidental or consequential damage, therefore above limitations may not apply to you. This warranty gives the purchaser specific legal rights. The purchaser may have additional rights, which vary from state to state.