



# INSTALLATION INSTRUCTIONS ROCK CRAWLER FRONT BUMPER

Part Numbers: 89430  
Application: Jeep JK 2007+

## GENERAL SAFETY PRECAUTIONS

Your safety, and the safety of others, is very important. To help you make informed decisions about safety, we have provided installation and operating instructions and other information on labels and in this guide. This information alerts you to potential hazards that could hurt you or others. It is not possible to warn you about all potential hazards associated with this product, you must use your own good judgment.

**CARELESS INSTALLATION AND OPERATION CAN RESULT IN SERIOUS INJURY OR EQUIPMENT DAMAGE. READ AND UNDERSTAND ALL SAFETY PRECAUTIONS AND OPERATING INSTRUCTIONS BEFORE INSTALLING AND OPERATING THIS PRODUCT.**

This guide identifies potential hazards and has important safety messages that help you and others avoid personal injury or death. **WARNING** and **CAUTION** are signal words that identify the level of hazard. These signal words mean:

**▲WARNING** signals a hazard that could cause serious injury or death, if you do not follow recommendations. **▲CAUTION** signals a hazard that may cause minor to moderate injury, if you do not follow recommendations.

This guide uses **NOTICE** to call attention to important mechanical information, and **Note**: to emphasize general information worthy of special attention.

## ▲ WARNING

### IMPACT AND MOVING PARTS ENTANGLEMENT HAZARD

Failure to observe these instructions could lead to severe injury or death

- Always use extreme caution when drilling on any vehicle. Make sure that all fuel lines, brake lines, electrical wires, and other objects are not punctured or damaged when/if drilling on the vehicle. Thoroughly inspect the area to be drilled (on both sides of material) prior to drilling, and relocate any objects that may be damaged. Failure to inspect the area to be drilled may result in vehicle damage, electrical shock, fire or personal injury.
- Always wear safety glasses when installing this kit. A drilling operation will cause flying metal debris.
- Always use extreme caution when cutting and trimming during fitting.
- Always remove jewelry and wear eye protection.
- Never lean over battery while making connections.
- Always insure components will remain secure during installation and operation.
- Always tighten all nuts and bolts securely, per the installation instructions.
- Always inspect, tighten, and replace damaged hardware before use.
- Always replace all worn or damaged parts before operating.
- Never operate this WARN product with damaged or missing parts.
- Never work under vehicle before properly securing vehicle.

Read installation and operating instructions thoroughly.

## BEFORE YOU BEGIN

The WARN Rock Crawler Bumper for the Jeep JK will accept a large range of mid frame winches with up to 12,000 lb. capacities. The Bumper has been designed to accommodate the standard 4-1/2 x 10" feet down mounting pattern as well as the 4-1/2x6" short drum pattern. An optional Winch Plate is available for mounting the WARN 8274-50.

The Rock Crawler Front Bumper is not compatible with the factory skid plate. It will not be reinstalled after the installation of the WARN bumper.

WARN INDUSTRIES, INC. 12900 S.E. Capps Road,  
Clackamas, OR USA 97015-8903, 1-503-722-1200, FAX: 1-503-722-3000  
Customer Service: 1-800-543-9276  
Dealer Locator Service: 1-800-910-1122  
International Sales/ Customer Service: 1-503-722-3008  
International Fax: 1-503-722-3005

## **⚠ CAUTION**

### **MOVING PARTS ENTANGLEMENT HAZARD**

Failure to observe these instructions could lead to minor or moderate injury

- Always take time to fully read and understand the installation and Operations Guide included with this product.
- Never operate this product if you are under 16 years of age.
- Never operate this product when under the influence of drugs, alcohol or medications.

Read installation and operating instructions thoroughly.

## **NOTICE**

### **EQUIPMENT DAMAGE**

- Always refer to the Installation and Specification Guide, supplied in the winch kit, for all wiring schematics and specific details on how to wire this WARN product to your vehicle.

Read installation and operating instructions thoroughly.

## **TABLE OF CONTENTS**

Parts List.....	page 2
Tools Required.....	page 2
Torque Specifications.....	page 2
Installation.....	page 3 - 8
Maintenance/Care.....	page 8

## **PARTS LIST**

<u>Description</u>	<u>Qty</u>	<u>Part Number</u>
RC Front Bumper	1	89430
Frame Bracket, LH	1	87408
Frame Bracket, RH	1	87409
Winch Mount Plate	1	87398
Canister Relocation Bracket	1	87369
Factory Fog Lamp Bracket	2	74715
Lamp Filler Bracket	2	74578
Hardware Kit	1	89433

## **TOOLS REQUIRED**

- Ratchet
- Standard Socket Set
- Metric Socket Set
- Standard Wrench Set
- Phillips Screwdriver
- Rotary Grinding Tool with Bit Set
- Hacksaw / Cutoff Wheel (Application Specific)

## **TORQUE SPECIFICATIONS**

1/4	8 lb. ft. (10.8 N-m)
5/16	17 lb. ft. (12.5 N-m)
3/8	30 lb. ft. (40.7 N-m)
7/16	50 lb. ft. (67.8 N-m)
1/2	75 lb. ft. (101.7 N-m)

# INSTALLATION INSTRUCTIONS

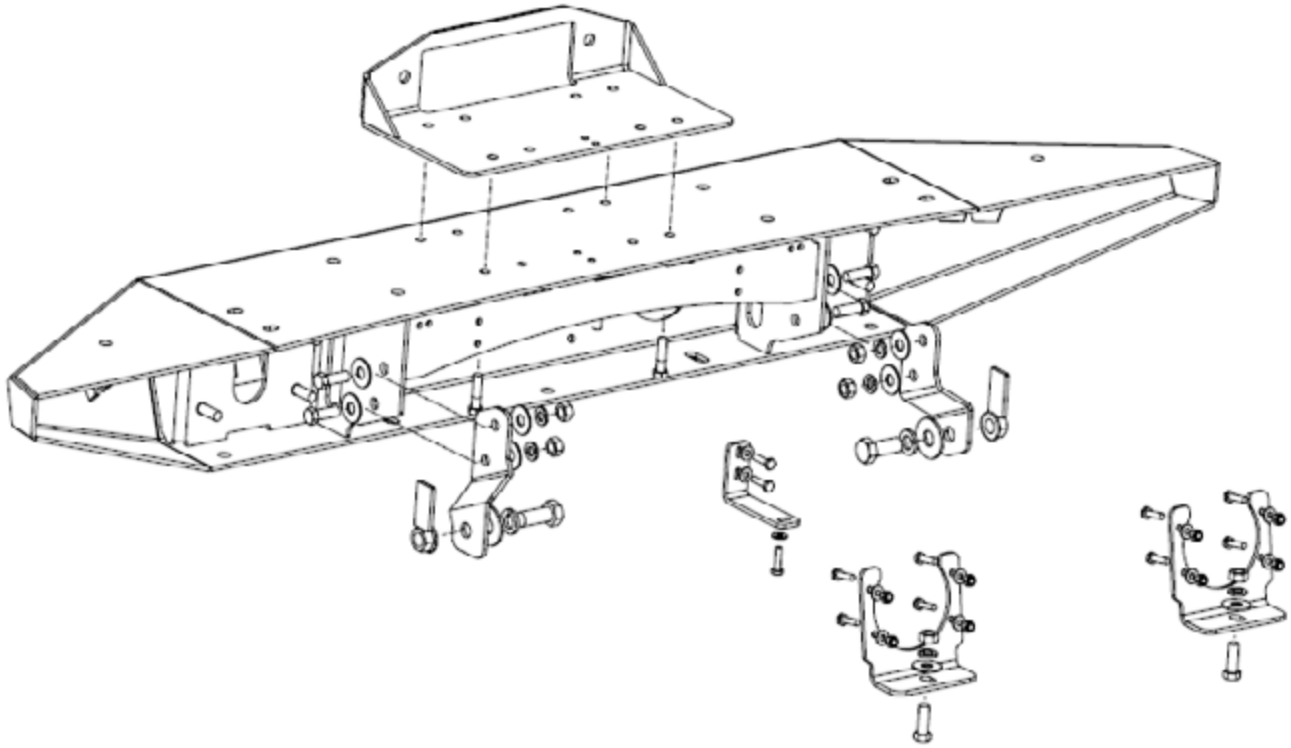

## INSTALLATION INSTRUCTIONS

1. Remove skid plate by removing 6 plastic Phillips head fasteners, 4 across the bottom of the bumper and 1 behind each end of the blocker beam. **Figures 2 and 3.**

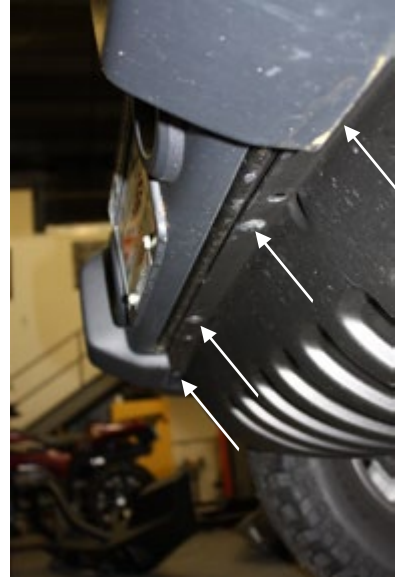

**Figure 2**



**Figure 3**

2. Unplug the factory fog lamps if equipped. Detach the wire harness from the bumper. **Figure 4.**
3. Remove the 8 nuts (4 each side) that secure the bumper to the frame ends. Access from behind the bumper.

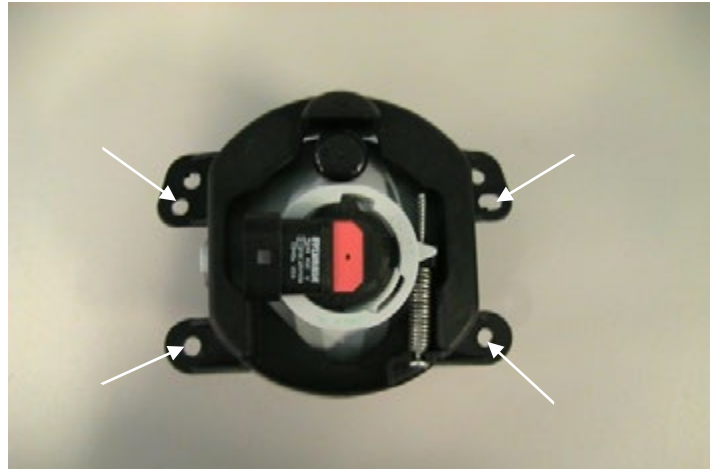

**Figure 4**

## INSTALLATION INSTRUCTIONS

**NOTE:** If not installing factory fog lamps skip steps 4-7

4. Remove the factory fog lamps by removing the 4 Phillips screws around each lamp. **Figure 5.**
5. Enlarge the 4 fog lamp mounting holes to 1/4".



**Figure 5**

6. Install the fog lamps in the Fog Lamp Brackets using 1/4-20 x 1" capscrews, flat washers and lock nuts. Make sure the fog lamp vents are on top. These fasteners should only be snug. Do not over tighten. **Figure 6.**
7. Install the fog lamps and Brackets. Use 7/16 x 1-1/2" capscrews, flat washers, lock washers and nuts. Adjust lamps and tighten.



**Figure 6**

**NOTE:** *Non-Factory Auxiliary Lights - Many 4" or smaller aftermarket fog and driving lamps can be used in the light ports if they can be mounted. Mount directly to the slots in the bumper. WARN has auxiliary light options that work in this application. Call Warn Customer Service or check online for a list of current available models.*

**NOTE:** *If vehicle is not equipped with a canister mounted to the inside of the driver side frame rail (2012 model year), skip steps 8-11, 13, 16*

8. Remove the canister from the inside of the driver side frame rail if equipped. Remove the 2 nuts and lift the canister over the studs and rotate it so the hose and fitting are facing forward. Allow it to carefully hang by the lines for now. **Figure 7.**



**Figure 7**

## INSTALLATION INSTRUCTIONS

- Trim the canister bracket as shown in **Figure 7**. Use a hacksaw or reciprocating saw with metal blade. Be careful not to damage any lines or wires. Touch up raw edge with paint to prevent rust. **Figure 8**.

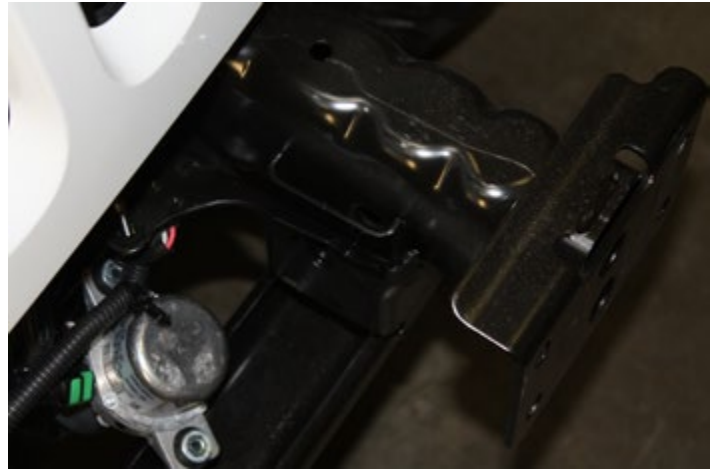

**Figure 8**

- Reinstall the canister by sliding the opposite “ear” over the remaining factory stud. Be careful not to strain or kink the lines or electrical connections. The vacuum line and fitting should now be facing forward with the vacuum line angled up and to the driver’s side. **Figure 9**.



**Figure 9**

- Use a grinder or file to enlarge the slot at the bottom of the factory canister bracket to match the frame hole behind it, about 5/8” diameter. **Figure 10**. Touch up raw edge with paint to prevent rust. **Figure 11**.

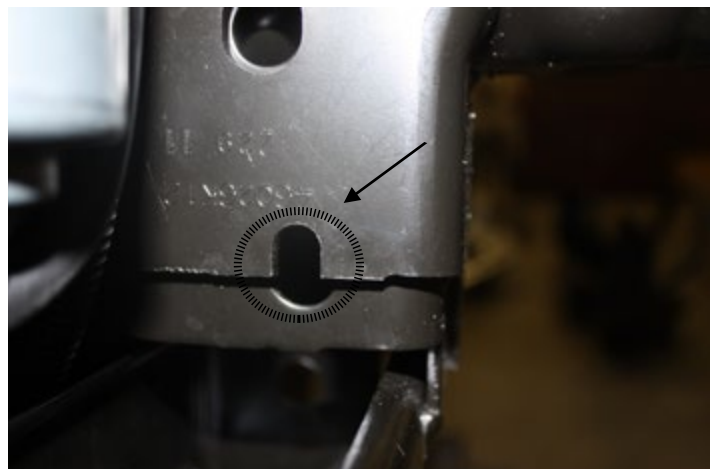

**Figure 10**

## INSTALLATION INSTRUCTIONS

12. Install the Frame Brackets using 5/8 X 1-1/2" bolts and flat washers. Use the 5/8" nutplates inside the frame. Position them as shown in **Figures 12 and 13**. Do not tighten yet.
13. Attach the Canister Relocation Bracket to the rear of the Bumper as shown in **Figure 14**. Use 1/4-20 x 1" capscrews, flat washers and lock nuts. Do not tight yet.
14. Install the Bumper by hanging it by the studs and installing flat washers, lock washers, and 7/16"-20 nuts. Do not tighten yet.
15. Attach the Frame Brackets to the Bumper with 2 each 7/16 x 1-1/4" capscrews and flat washers, lock washers and hex nuts per side. Do not tight yet.
16. Attach the "free" ear of the canister to the Relocation Bracket with the 6mm capscrew, flat washer and factory 6mm flange nut. Secure the other ear to the factory stud using the original flange nut. **Figure 15**.
17. Tighten the hardware to the correct specifications. Tighten the 8 Bumper mounting nuts, the 4 Frame Bracket to Bumper bolts then the 5/8" Frame Bracket to Frame bolts. Next, tighten the Canister Relocation Bracket then the canister.
18. Connect the fog lamps and secure the harness.
19. If installing a winch, do so now. Attach the Fairlead to the supplied Winch Plate using the hardware supplied with the winch or fairlead. If installing a Warn 8274 use the optional 8274 Winch Plate, p/n 87675.
20. Place the Winch Plate between Winch and Bumper and align the holes with those in the Bumper before installing the winch. Use the longer 3/8" x 1-1/2" capscrews supplied with this kit to mount the Winch. Tighten to the torque specification supplied with the winch.
21. Holes are provided in the Bumper face for license plate installation (if required by state law).

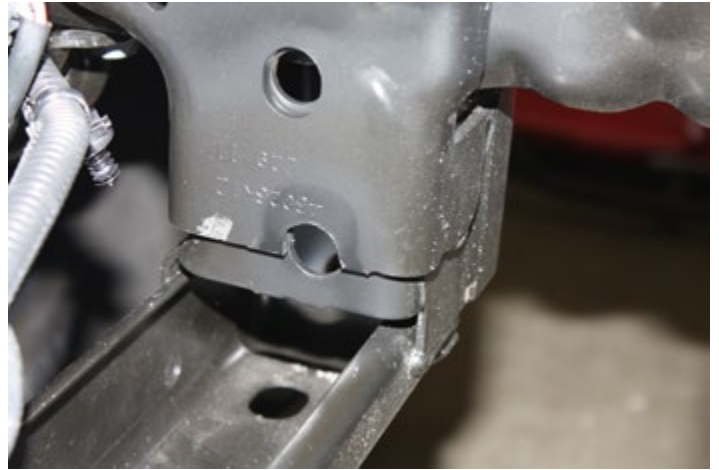

**Figure 11**



**Figure 12**



**Figure 13**

## INSTALLATION INSTRUCTIONS



Figure 14

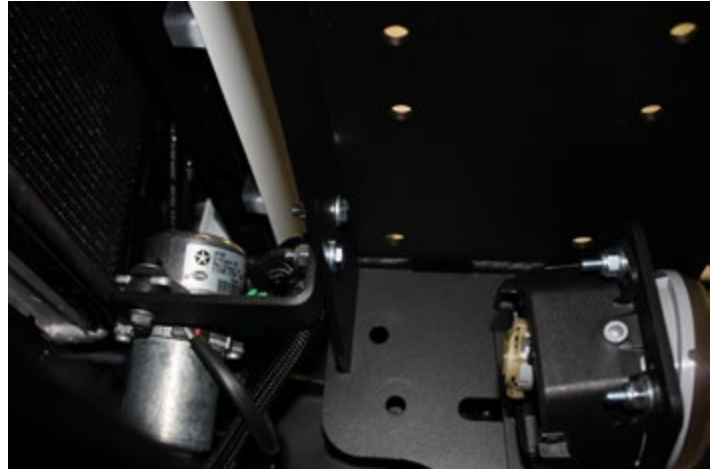

Figure 15



Figure 16

### **⚠ WARNING**

- Drilling operations can cause flying metal chips. **WEAR SAFETY GOGGLES.** Flying metal chips can cause eye injury.
- **FAILURE TO SECURELY TIGHTEN ALL BOLTS ON THE FRAME BRACKETS AND BUMPER CAN RESULT IN PRODUCT FAILURE WHICH MAY RESULT IN VEHICLE DAMAGE AND OPERATOR INJURY OR DEATH. DOUBLE CHECK THAT ALL BOLTS ARE SECURELY TIGHTENED PRIOR TO USE.**

### **MAINTENANCE / CARE**

- Inspect all parts on the frame brackets and bumper hardware periodically. Replace all hardware that appears rusted or deformed.
- Inspect all nuts and bolts periodically. Tighten all nuts that appear to be loose. Stripped, fractured, or bent bolts or nuts need to be replaced.

**CARELESS INSTALLATION AND OPERATION CAN RESULT IN SERIOUS INJURY OR EQUIPMENT DAMAGE. READ AND UNDERSTAND ALL SAFETY PRECAUTIONS AND OPERATING INSTRUCTIONS BEFORE INSTALLING AND OPERATING THIS PRODUCT.**

