

Jeep Wrangler

X409-WRA-JL

9" Restyle In-Dash System

Installation Manual

- Model: Wrangler JL 2018-Up
- Model: Gladiator JT 2020-Up

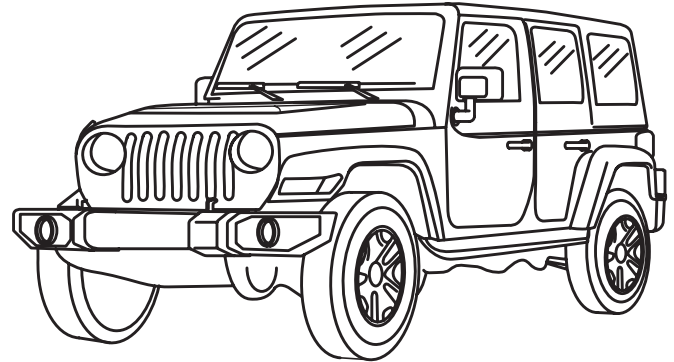

Jeep	Model	Year
	Wrangler JL	2018 - Up
	Gladiator JT	2020 - Up

* The specified vehicles have been tested and have met compatibility specs at the time of testing. Compatibility is not guaranteed if the manufacturer has made production changes to the listed vehicles above.

Introduction

- Congratulations on purchasing the X409-WRA-JL. This installation manual is designed to take you through the step-by-step installation of X409-WRA-JL into a 2018-Up Jeep Wrangler JL or Jeep Gladiator JT 2020-Up. Please familiarize yourself with the owners manual as this is a challenging installation. If you still have additional questions please call 1-800-TECH-101.



Note

- Design and specifications are subject to change without notice for improvement.





To Ensure Safe Use, Always Follow These Precautions

- The installation of this product requires specialized skills and experience. This is an installation that is challenging and time consuming even for installers with experience. A professional installer would typically take a minimum of 3-4 hours to complete this installation. We recommend that you have the product installed by an Alpine authorized dealer.
- Before you use this product, be sure to carefully read this installation manual and the separate user's manual so that you can use the product correctly. Alpine Electronics bears no responsibility for problems that arise as a result of failure to follow the instructions in the manuals.
- This manual includes a number of symbols that are intended to help you use the product safely, to prevent harm to you and others, and to protect against damage to property. These symbols and their meanings are listed below. Make sure you fully understand these symbols before you begin reading the main text.

Explanations of Injury and Damage That May Result from Incorrect Use

 Warning	Ignoring the content marked by this indication and using the product incorrectly is expected to lead to death or serious injury.
 Caution	Ignoring the content marked by this indication and using the product incorrectly is only expected to lead to injury or property damage.

Types of Precautions

 Forbidden	Indicates actions that are forbidden (must not be performed)
 Forbidden	Indicates that disassembly is forbidden.
 Mandatory	Indicates actions that are mandatory (must be performed)
	Marks content that should receive your full attention.

 **Warning**

Do not disassemble or modify the product. Doing so could lead to an accident, fire, or electric shock.



Forbidden

Store screws and other small objects where children cannot reach them. If one of these small objects is swallowed, consult with a doctor immediately.



When replacing fuses be sure to use the fuses with the specified current rating. Failing to do so could lead to an accident or fire.



Mandatory Forbidden

Only connect the product to a 12 VDC negative ground car. Failing to do so could lead to an accident or fire.



Mandatory

Since this vehicle has two batteries, disconnecting the battery is not a good option. Take caution when testing circuits. Failing to do so could lead to electric shock or injury.



Do not cut the insulation on a cord and take power from another device. Doing so could lead to fire or electric shock.



Forbidden

Do not install the product in a location where it will obstruct the driver's forward view; interfere with the operation of the steering wheel, gear shift, or the like; or pose a threat to passengers. Doing so could lead to an accident or injury.



Forbidden

When making a hole in the vehicle body, be careful to avoid damaging pipes, the fuel tank, electrical wiring, and the like. This kind of damage could lead to an accident or fire.



When installing and grounding the product, do not use any of the bolts or nuts of the steering wheel, brakes, fuel tank, or the like. Doing so could make the brakes stop working or could lead to fire.



Forbidden

Do not install the product near the passenger-side airbag. Doing so could interfere with the operation of the airbag and lead to an accident or injury.



Forbidden

Bundle cords so that they don't interfere with driving. Wrapping cords around the steering wheel, gearshift, brake pedal, or the like could lead to an accident or damage equipment.



 **Caution**

Connect the product properly according to the instructions. Failing to do so could lead to fire or an accident.



Forbidden

Do not sandwich cords between the seat railing or allow them to touch protrusions. Resulting breaks or shorts could lead to electric shock or fire.



Do not block vents or heat sinks. Doing so could lead to fire or damage equipment.



Use the accessories according to the instructions, and attach them securely. Failing to do so could lead to an accident or damage equipment.



Forbidden

Do not install the product where it may be exposed to water or in a place with high levels of humidity or dust. Doing so could lead to fire or damage equipment.







Forbidden



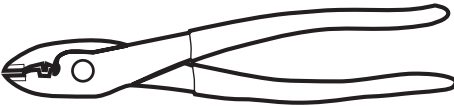
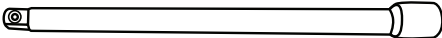
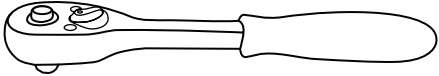
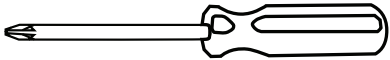
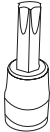
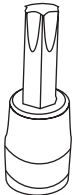

The installation and wiring of this product requires specialized skills and experience. Have the product installed by an Alpine authorized dealer.

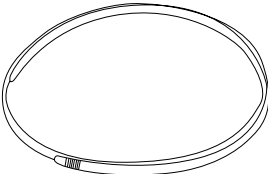
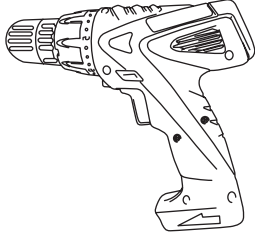
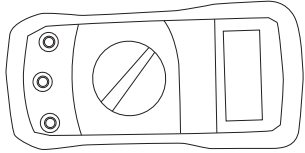



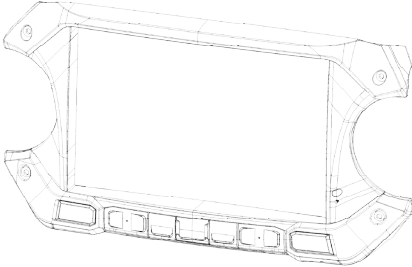

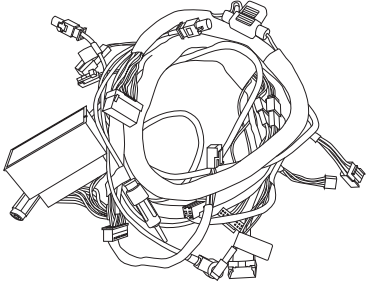
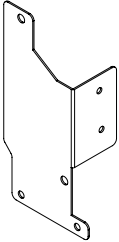
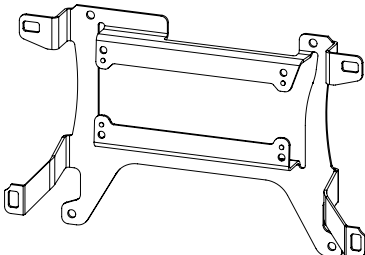
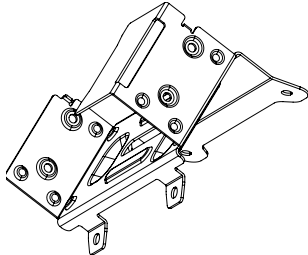
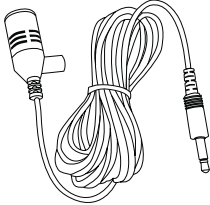
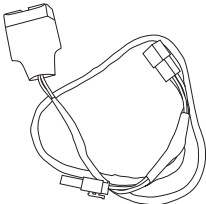
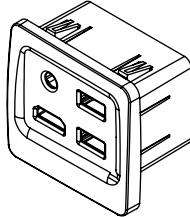
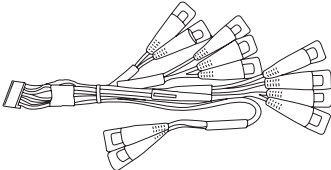
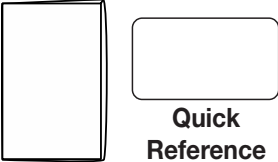
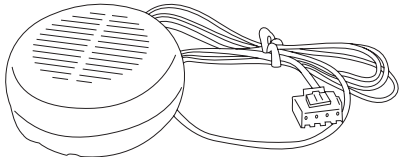
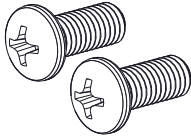
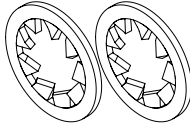
Tools Required

<p>10mm Socket</p> 	<p>8mm Socket</p> 	<p>7mm Socket</p> 
<p>Wire Cutters</p> 	<p>Extension</p> 	<p>Ratchet</p> 
<p>#2 Phillips Screwdriver</p> 	<p>Torx T20</p> 	<p>Torx T47</p> 
<p>Panel Removal Tools</p> 	<p>Wire Fishing Tool</p> 	<p>Cordless Power Drill</p> 
<p>Digital Multimeter</p> 		

Accessory List

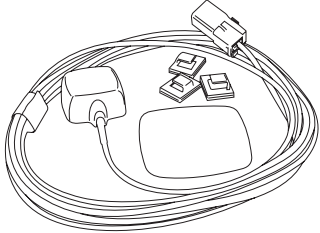
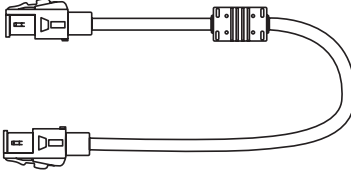
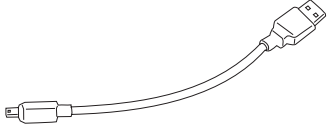
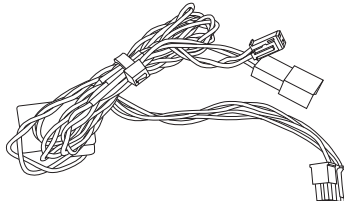
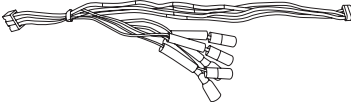
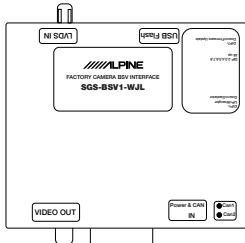
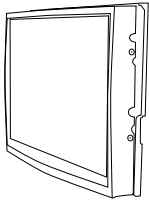
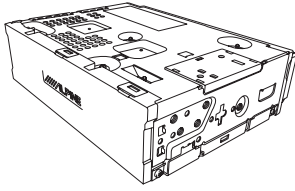
<p>Display Bezel</p> 	<p>Maestro Module</p> 	<p>Main Harness</p> 
<p>Power Inverter Bracket</p> 	<p>Display Bracket</p> 	<p>Tuner Bracket</p> 
<p>External Bluetooth Mic</p> 	<p>USB Power Adapter</p> 	<p>USB, HDMI, Aux Interface</p> 
<p>Aux/Preout Harness</p> 	<p>Documents</p>  <p>Alpine Registration Card</p> <p>Quick Reference Guide</p>	<p>Chime Speaker</p> 
<p>Screws M5X10LMM x 2</p>	<p>Lock Washers x 2</p>	<p>Screws M5X8LMM x 8</p>
		

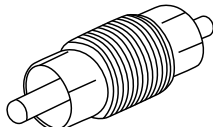
Accessory List Continued

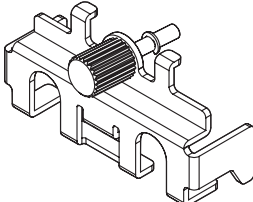
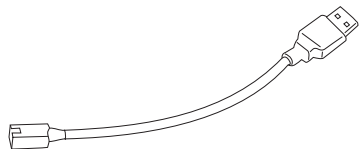
<p>GPS Antenna</p> 	<p>Display Cable</p> 	<p>Maestro Programming Cable</p> 
<p>Camera Power Harness</p> 	<p>Display Power Harness</p> 	<p>Camera Module</p> 
<p>X409 Display Unit</p> 	<p>X409 Source Unit</p> 	<p>Key Harness</p> 
<p>Camera Male To Male RCA Coupler</p> 	<p>Direct Camera Adapter</p> 	<p>Source Unit HDMI Bracket</p> 
<p>Mini USB To USB For Center Console Power</p> 		

Programming The iDataLink Maestro Module

1 INSTALL THE WEBLINK PLUG-IN

Go to:

idatalinkmaestro.com/plugin and follow the installation steps. The Maestro module must be programmed specifically for each vehicle and radio. Take care to enter the correct vehicle information, factory options, head unit model, and head unit serial number. The head units serial number is an alphanumeric value which is found on the head units label, underneath the bar code.

Review the System Requirements before installing.

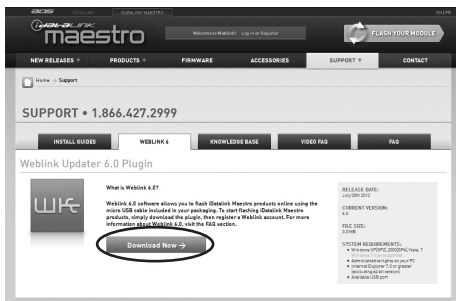

If the plugin is already installed, the caution, "The plugin is already installed" appears. Please skip to step 2.

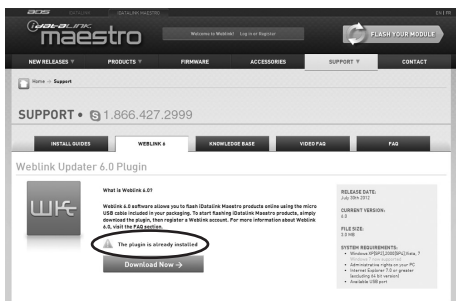

3 CONNECT YOUR MAESTRO MODULE

Use your Maestro module to connect to your PC.

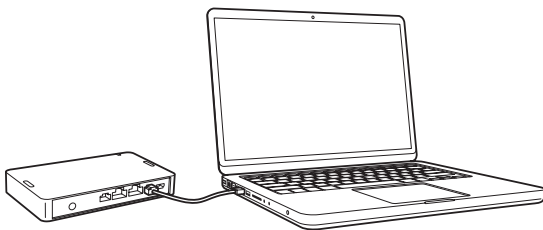

5 PROGRAM YOUR MODULE

Follow the programming steps for your vehicle.



2 REGISTER A WEBLINK ACCOUNT

Go to:

idatalinkmaestro.com/register and complete the registration process.

A confirmation email will be sent to you requiring validation.

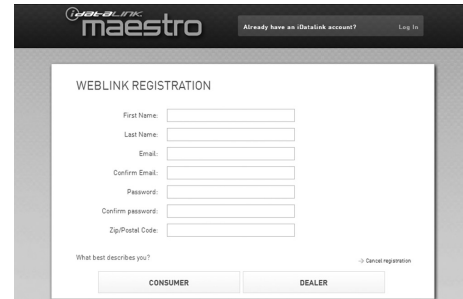

For existing customers, click log in.



4 LOG INTO WEBLINK

Go to:

idatalinkmaestro.com/login.

Enter your username and password, then click OK.



6 Once Programming is complete "FLASHING COMPLETED!" will be displayed.

Proceed to the next page to complete installation.

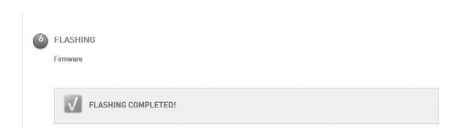

NOTE: If serial number is invalid, Call ADS at 1-866-427-2999 with the serial number.

About The Installation

The different trim levels of the Wrangler JL and the Gladiator JT come with different options which will make the installation vary slightly. If the vehicle has the 115V Power outlet or the Cold Weather Group package then there are different brackets that will need to be used. If your vehicle does not have those then you will not need to use those. If you are installing the X409-WRA-JL in a Gladiator JT then a few of the steps will vary slightly so please take notice to this as you go through the installation. Also the screen size in the pictures may be different if you have the 5.0" display. The following chart shows which options are available on the different trim levels for the Wrangler JL.

2019 Jeep Wrangler	Sport	Sport S	Sport Altitude	Sahara	Rubicon	Sahara Altitude	MOAB
5.0" Touchscreen Display	Standard	Standard	Standard	Not Available	Not Available	Not Available	Not Available
7.0" Touchscreen Display	Not Available	Not Available	Not Available	Standard	Standard	Standard	Standard
115V Power Outlet	Not Available	Not Available	Not Available	Standard	Standard	Standard	Standard
Cold Weather Group	Not Available	Optional	Optional	Optional	Optional	Optional	Optional

Retained Features

STEERING WHEEL CONTROLS	
Two Functions on Each Button	■
Standard and Expanded Radio Functions	■
NAVIGATION OUTPUTS	
Accessory Power Output (15A)	■
Parking Brake Output	■
Reverse Light Output	■
Vehicle Speed Pulse Output	■
Foot Brake Output	■
FACTORY AMPLIFIER	
Amplifier Turn on	■
Speed Compensated Volume (Premium Audio)	■
Digital Fader (Premium Audio)	■
DSP Settings (Premium Audio)	■
Gain Adjustment (Premium Audio)	■
SECONDARY VEHICLE DISPLAY (IF EQUIPPED)	
Audio Information Display	■
Hands Free Info Display	■
Navigation Info Display	■
VEHICLE SETTINGS	
Access And Modify Vehicle Settings	■
ADVANCED CAMERA FEATURES	
Front Camera Auto Control (Not Retained)	X
CLIMATE CONTROL	
Climate Display And Control On Radio	■
GAUGES	
Selectable Performance Gauges	■
"Track Pack" Gauges	■
Read/Reset Check Engine Codes	■
PARK ASSIST	
Retain Parking Assist Chimes	■
Distance Display On Screen	■
VEHICLE INFO	
Tire Pressure Display	■
Battery Voltage Display	■
Read/Reset Check Engine Codes	■
Door open Status and Warning	■
ACCESSORIES	
OEM Accessory Control Integration	■

Factory Unit Disassembly Process

- 1** As a precautionary measure it's a good idea to mask out the dashboard and panels to prevent scratches.



- 2** Unsnap the 6 clips and remove the knee panel under the steering wheel using a panel removal tool.



- 3** The locations of the 6 clips from the previous step.

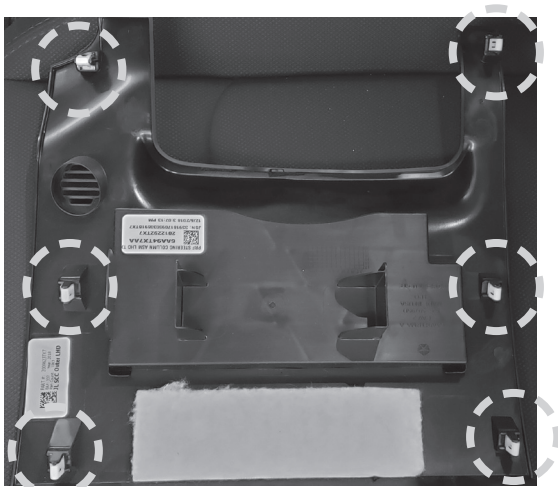

- 4** Unsnap 10 clips, unplug the 2 harnesses, and remove HVAC panel using a panel removal tool.



- 5** Locations of the clips and harnesses of the HVAC controls from the previous step.



- 6** Use #2 Phillips Screwdriver to extract (2) screws from the bottom of the radio bezel.

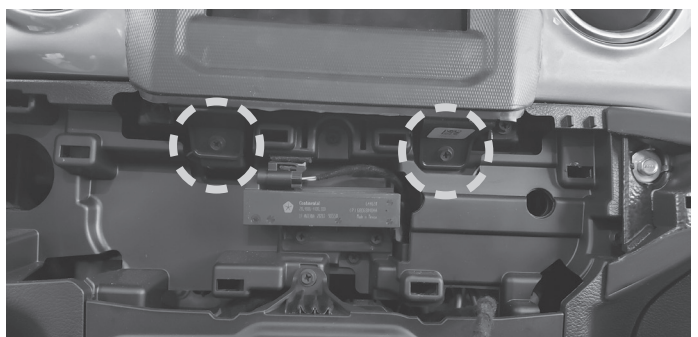

Factory Unit Disassembly Process (Continued)

- 7 Unsnap 6 clips and remove radio bezel using a panel removal tool.



- 8 Unsnap the 6 clips and remove the knee panel under the steering wheel using a panel removal tool.



- 9 Use #2 Phillips Screwdriver to extract (4) screws from head unit. Disconnect and remove the radio.

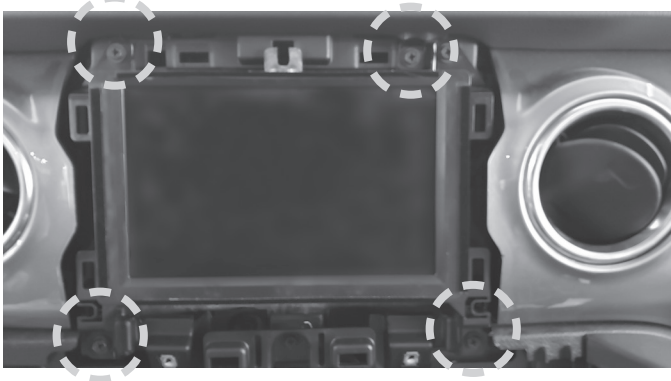

- 10 Disconnect the harnesses behind the OEM head unit.



- 11 The disconnected harnesses from the previous step. These will be used later to connect to the main harness in the installation.

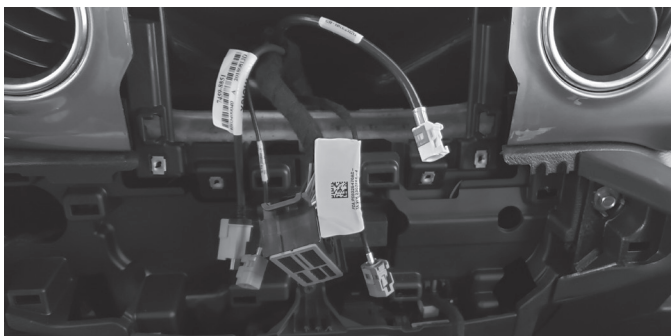

- 12 Open the glove compartment and remove all contents, push up the glove compartment travel stop and lower the door, pivot the glove compartment downward, release latch on left side of the glove compartment by pushing it upward, pull the glove compartment upward to remove it from the pivot.



Factory Unit Disassembly Process (Continued)

- 13** For vehicles with the power inverter remove the ventilation duct behind the drivers side knee panel using a panel removal tool to release the one clip holding it in place. Once the installation of the X409-WRA-JL tuner is completed the vent can go back in place.

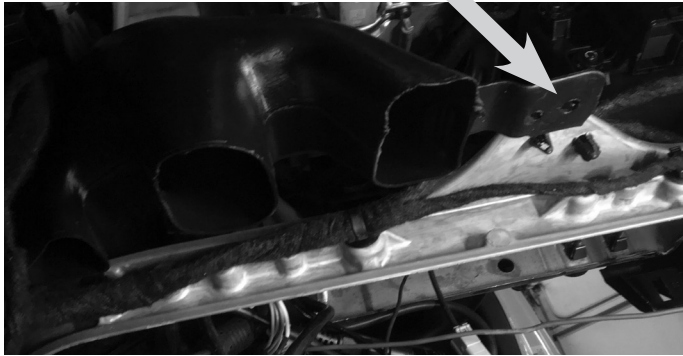

- 14** For vehicles with heated seats or the power inverter the bracket for the module needs to be removed. Remove the (4) 10mm screws to remove the bracket. Then remove the (2) 8mm screws lower and the (2) 10mm screws top to remove the module.

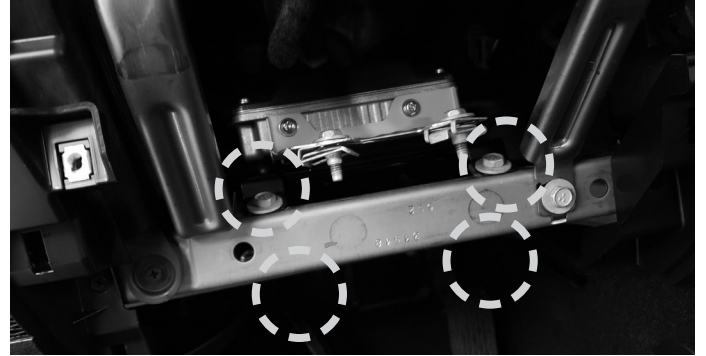

- 15** Remove the two knee panel brackets. Each bracket is held in by (1) 10mm screw.

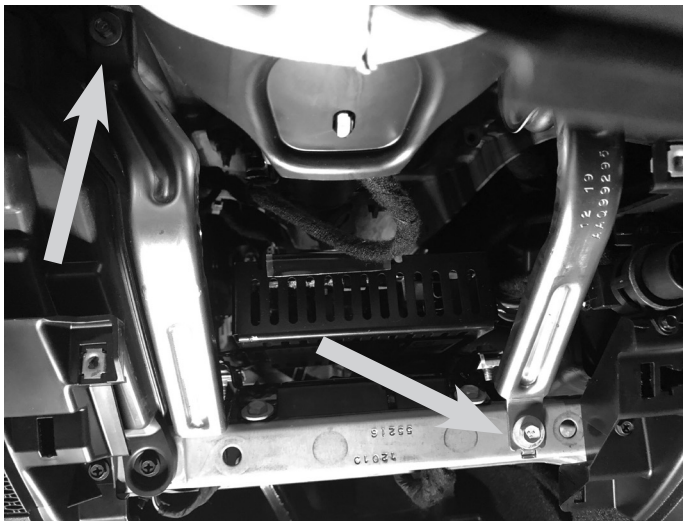

- 16** Remove the A pillar by removing the (2) 8mm screws and unclipping the panel. The screws can be exposed using a panel removal tool.



Factory Unit Disassembly Process (Continued)

17 Loosen the clips around the top panel visor area.



18 Remove panel above drivers door going to the B pillar.



19 Unclip 7 clips and remove the center media stack.



Installation Instructions

- 1** Run the GPS antenna Bluetooth microphone cables up the A pillar along the OEM wiring. Route as shown on the diagram on page 17.



- 2** Mount the microphone next to the rear view mirror and run the cable behind the factory panels. Route as shown on the diagram on page 17.



- 3** Mount GPS antenna near driver side B-pillar as illustrated on page 17 and run the cable to the knee panel.



- 4** Route radio cables including Radio Main, Sirius XM, FM, and Aux in main harness and also the display cable from radio cavity to knee panel.



- 5** Route vehicle cable in main harness from radio cavity to glove box and connect it to OBDII gateway behind the glove box. If the gateway is fully occupied, unclip 1 connector from it and use T-harness.



- 6** Attach tuner bracket to tuner using (4) M5X8LMM supplied screws.

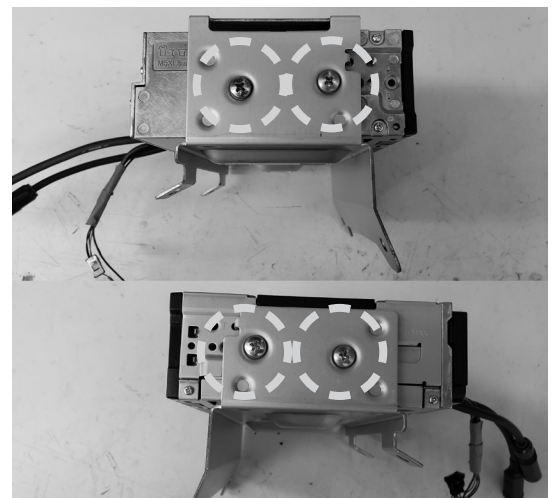

Installation Instructions (Continued)

- 7 If you are using the optional SiriusXM tuner, Cable tie the module on top of the source unit.

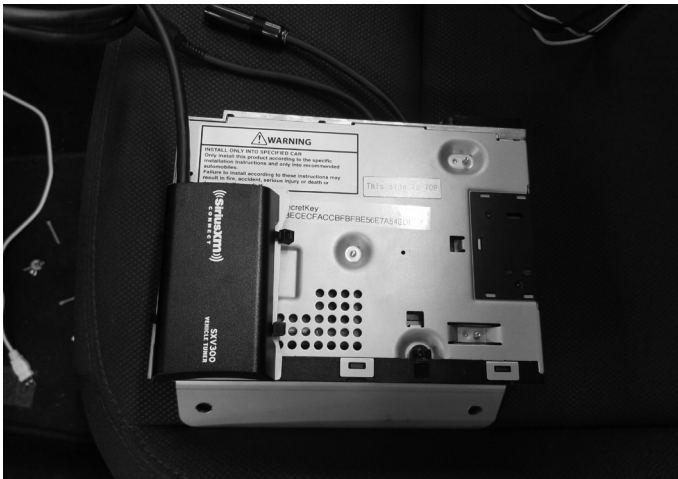

- 8 For vehicles with heated seats or the power inverter attach the Power Inverter bracket using the supplied (2) M5X10LMM screws and lock washers. This will mean you will not use two of the M5X8LMM screws from the previous page. These two screws are slightly longer and can make it through both brackets.

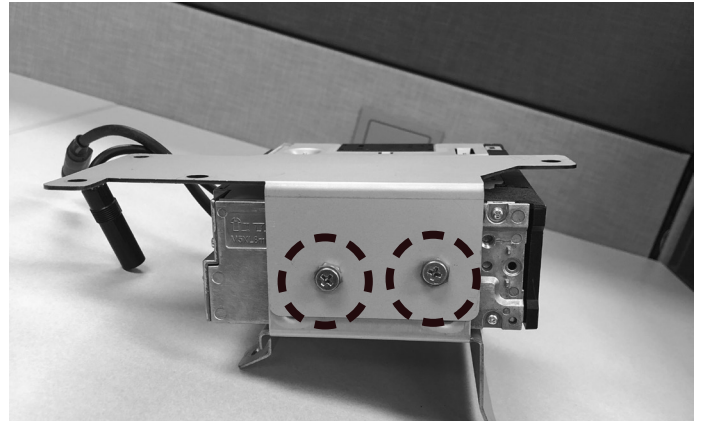

- 9 Use the factory speed clips from the bracket that was removed from the vehicle and attach them to the Power Inverter bracket. For the Wrangler JL use the 2 holes circled in black. For the Gladiator JT use the 3 holes pointed out by the arrows.

- 10 After attaching the factory speed clips this is what the bracket will look like for the Wrangler JL.

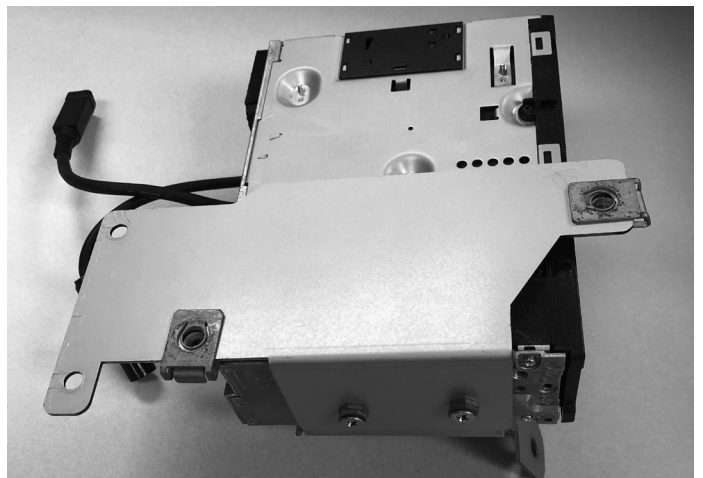
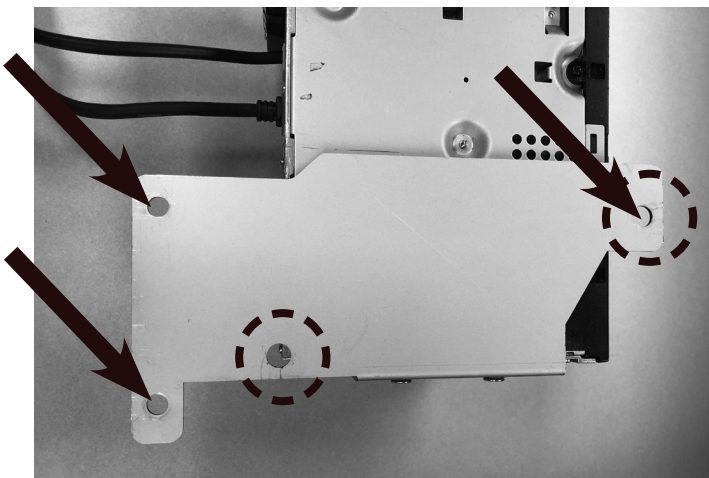

Installation Instructions (Continued)

- 11** Attach the factory Power module to the bracket using the OEM screws. This is what the power module will look like for the Wrangler JL.

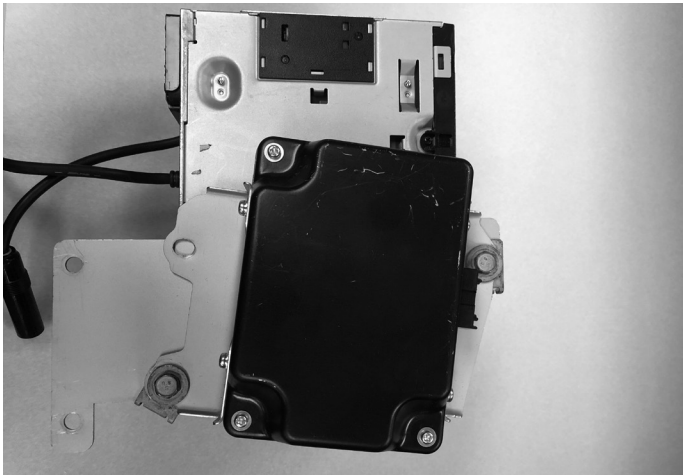

- 12** Attach the factory Power module to the bracket using the OEM screws. This is what the power module will look like for the Gladiator JT.

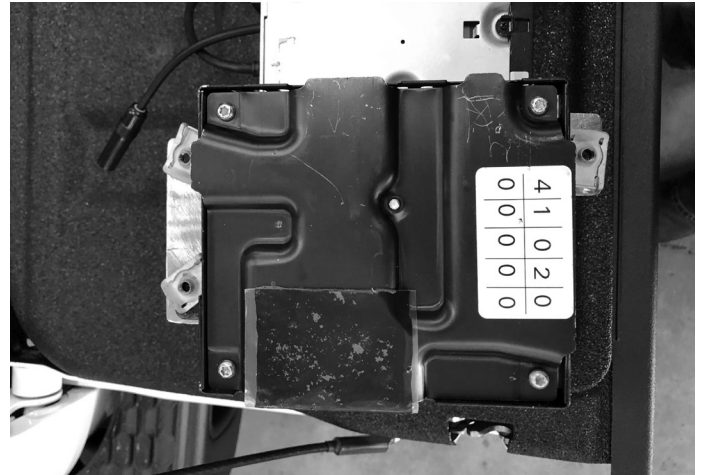

- 13** If the vehicle has the heated seat module clip that into the bottom bracket. The OEM clips on the module will snap into the bracket.

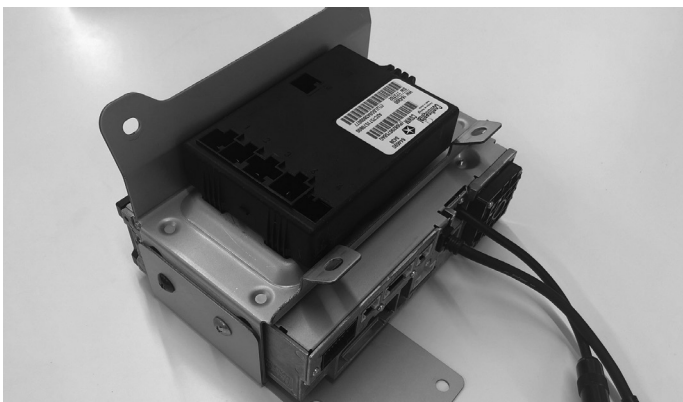

- 14** Use (4) OEM bolts to secure the X409 source unit tuner bracket to the vehicle. If the vehicle is equipped with the power inverter it will mount behind the 2nd cross bar.



Installation Instructions (Continued)

15 At the knee panel, connect the main harness, display harness, GPS antenna, microphone, USB cable, HDMI, FM adapter, and other adapters to X409 source unit and secure them.

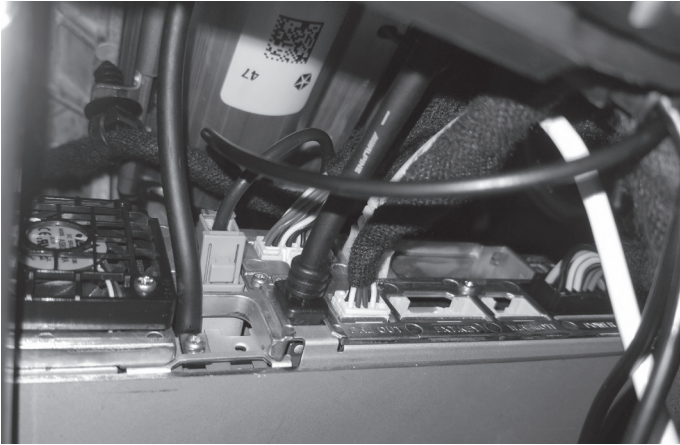

16 At radio cavity, connect the main harness, white FM adapter, and green SiriusXM antenna, and other adapters to factory harness and secure them.

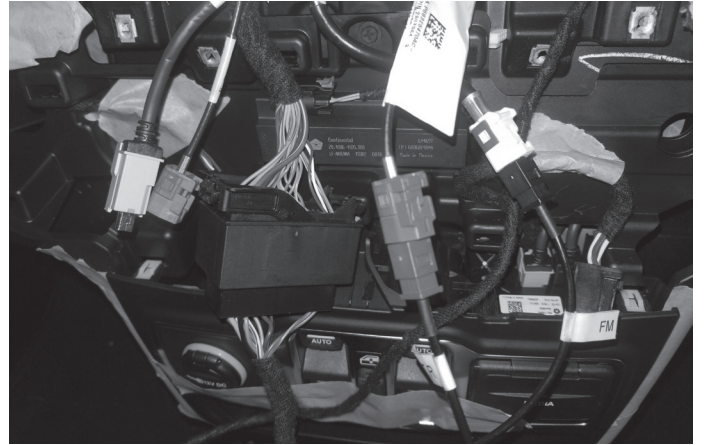

17 Connect the camera interface module to the violet or red factory camera plug and put it in right side of radio cavity. Dip switch 1 will need to be moved down for the Gladiator JT.



18 Attach the Maestro to the main harness and tuck it in left side of radio cavity.

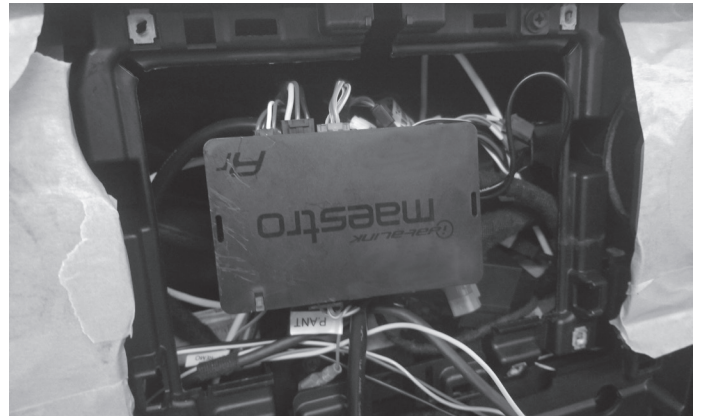

19 Run chime speaker harness from Maestro module to behind the glove box and attach there.

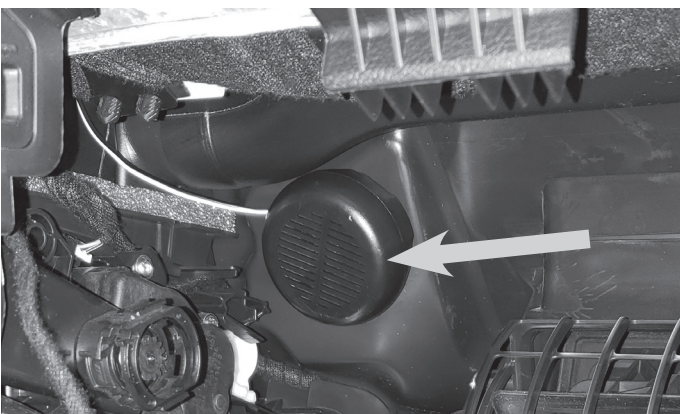

20 Remove the OEM USB from the Center Media panel by unclipping the clips on the sides.

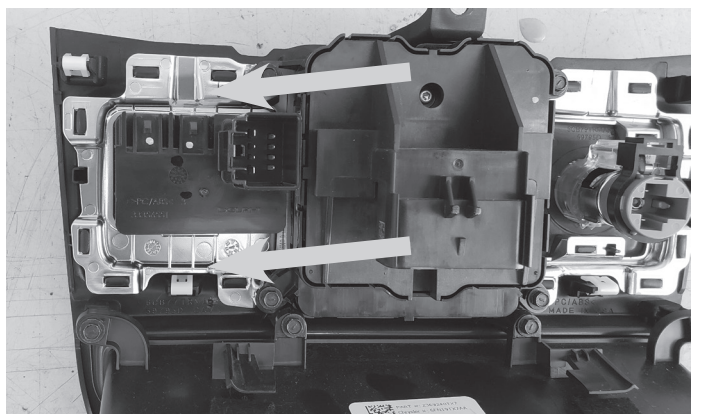

Installation Instructions (Continued)

- 21** Insert the X409 USB HDMI box into the OEM Center Media panel.



- 22** Plug in the OEM USB and the USB from the box to the power adapter. The adaptor needs to be plugged into the BLACK micro usb.



- 23** **WARNING:** There are 2 factory micro USB plugs in the dash behind the media center. One is black and one is grey. If the supplied adaptor is plugged into the grey micro USB the factory USB's will not charge. When it is plugged into the black plug all rear USB's will charge.



- 24** Attach the display unit to the display bracket using the (4) M5X8LMM supplied screws.



- 25** Attach the display and bracket to the vehicle using the OEM screws from the OEM radio.



- 26** Plug in the bezel and and reinstall all the factory panels.



Component Locations

! IMPORTANT: Follow the recommended component location shown below. Failure to do so, will result in poor GPS performance.

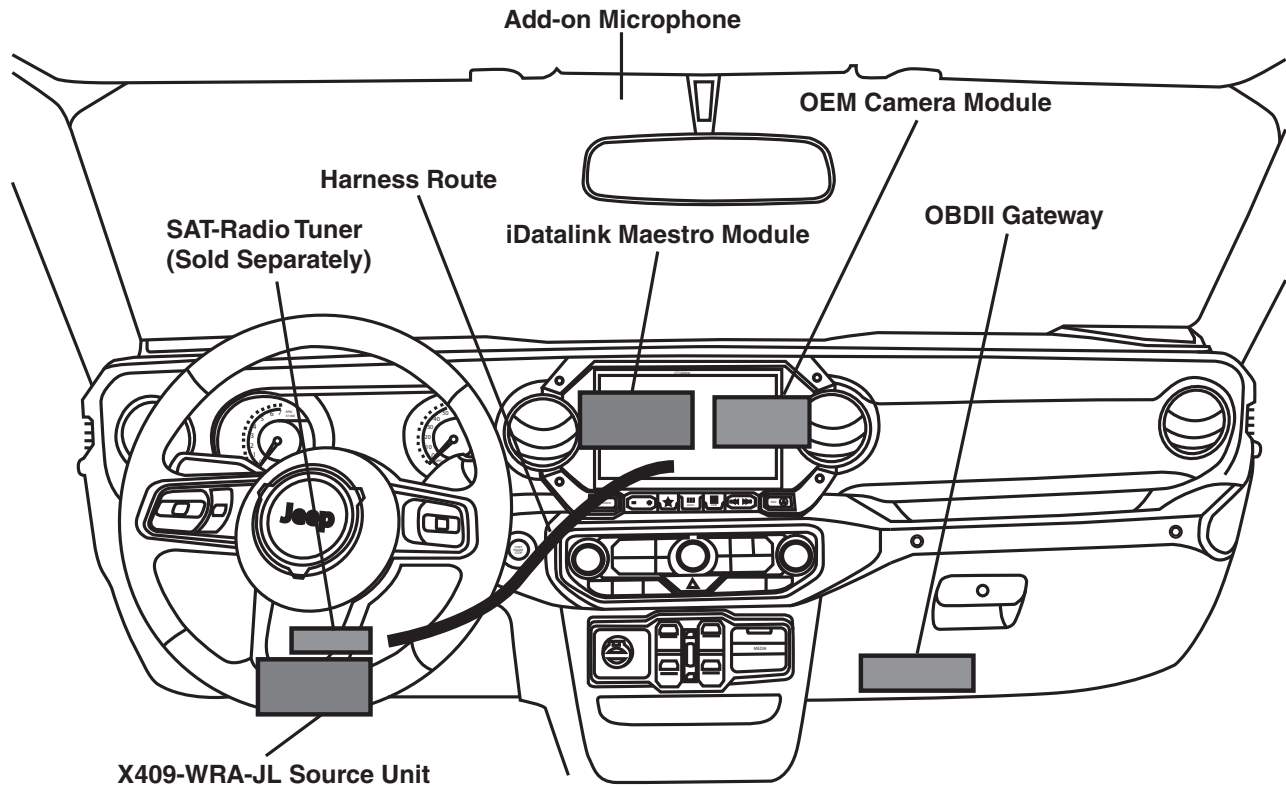

GPS Antenna Installation

! IMPORTANT: Follow the GPS antenna installation procedure shown below. Failure to do so will result in poor GPS performance for CarPlay, Android Auto, and off-road navigation.

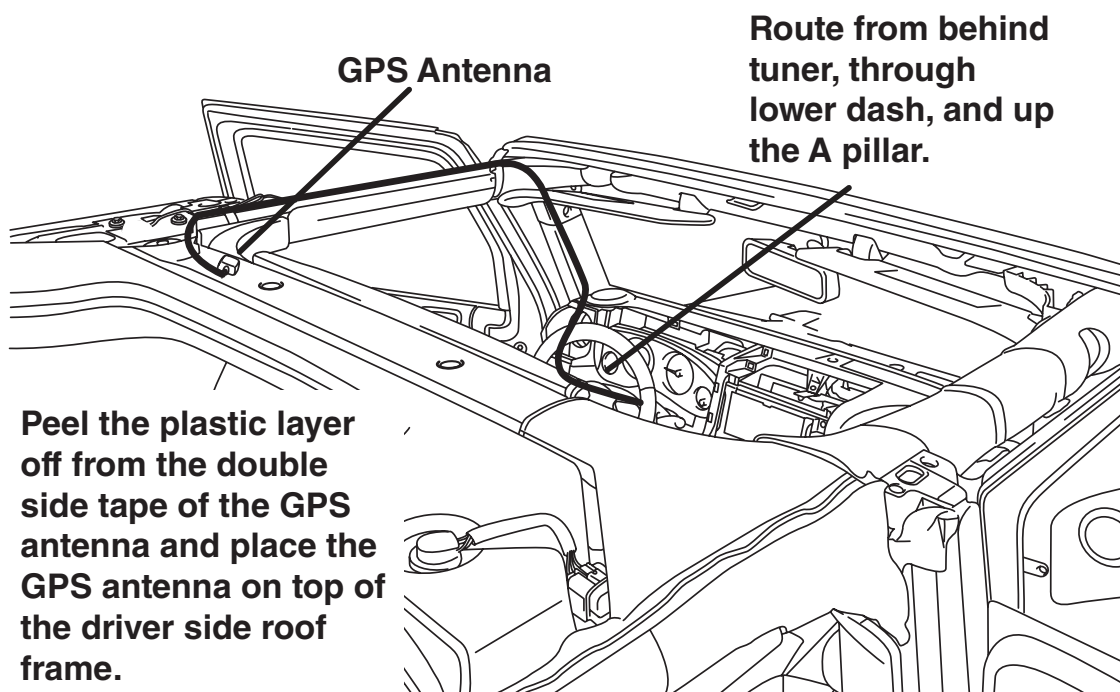

X409-WRA-JL Wiring Diagram

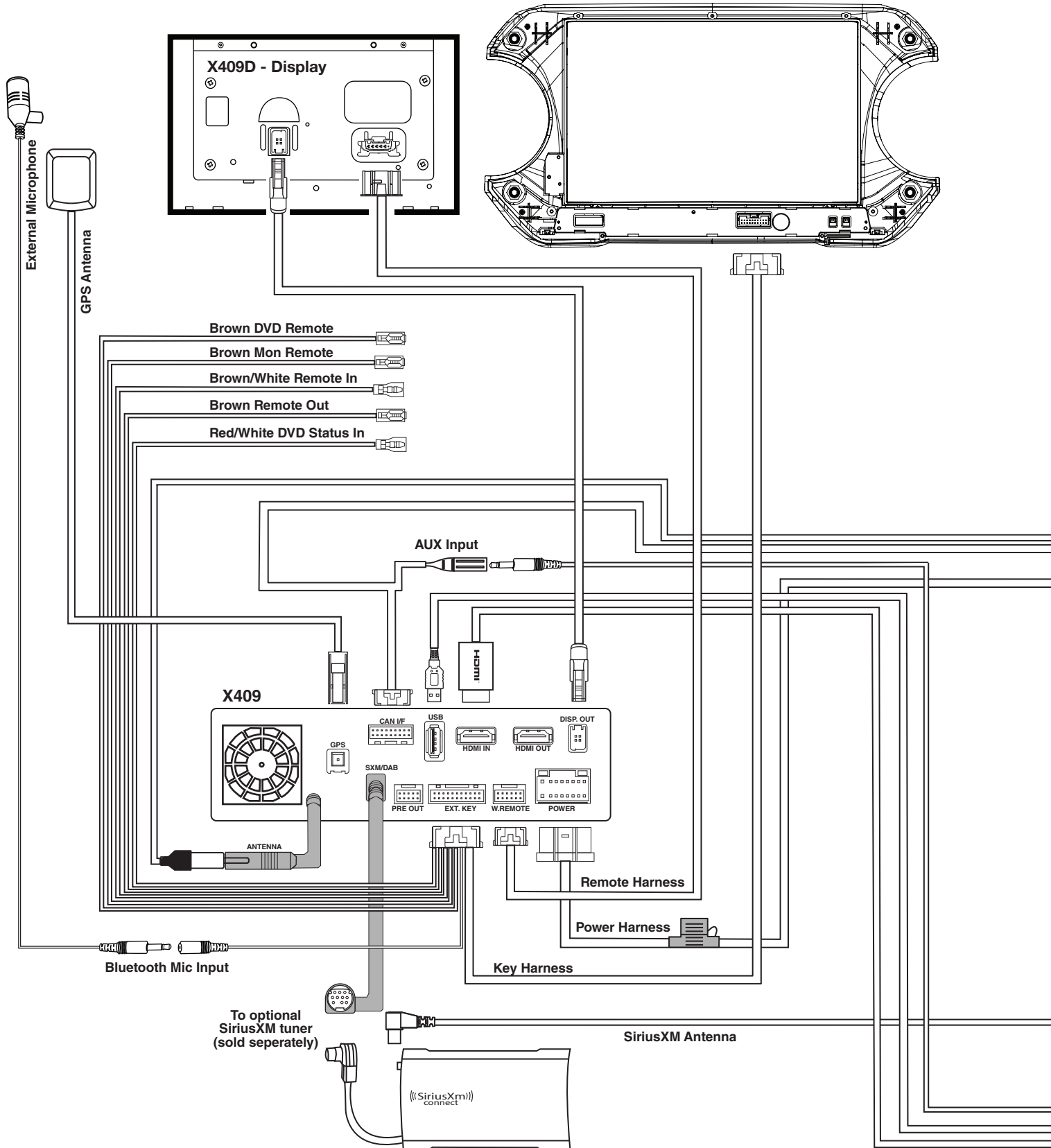

X409-WRA-JL Wiring Diagram Continued

To Vehicle Connectors

SXM Antenna (Green)
FM Antenna (White)

AMPLIFIED VEHICLES

WARNING!

Failure to follow this procedure will result in no audio from Navigation and Bluetooth sources.

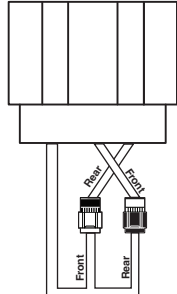

For factory amplified vehicles switch the speaker connectors, front to rear and rear to front.

Power Speaker 52-pin Connector

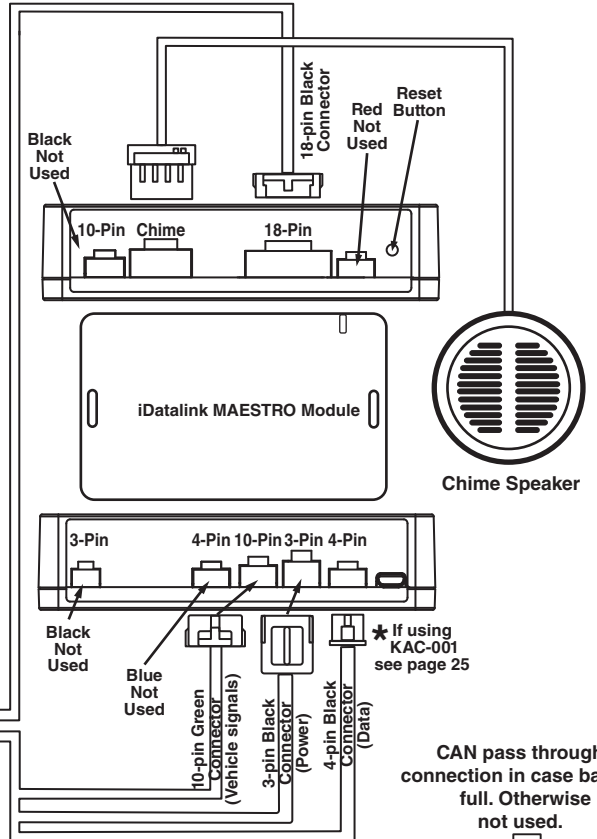
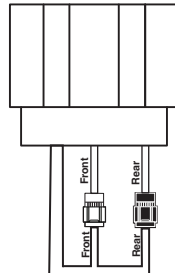

Chime Speaker



Rear Camera (Violet or Red)

See Page 24
Dip Switch 1 should be up for the Wrangler and down for the Gladiator. The rest of the switches are not used.

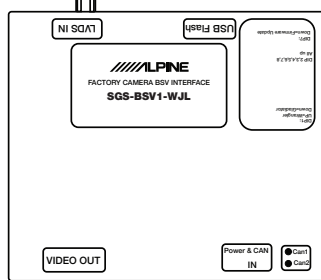

ACC CAN

Camera Power

Direct Camera

To CAN Connector

CAN pass through connection in case bank is full. Otherwise not used.

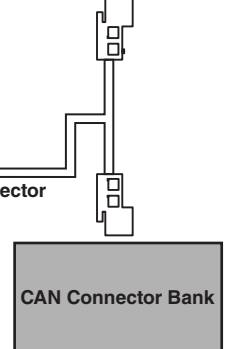

CAN Connector Bank

Blue Power Antenna

Blue/White Amp Turn-on

Aux Power pass through covered by protective cap

Aux Power

Direct Camera Adapter

USB, AUX, HDMI Interface

Aux Input

USB

HDMI

USB Power

Mini USB To USB

To Center Console USB Power connector in vehicle

This must be plugged into the black micro USB. See page 16 for details

Connection Of An External Amplifier

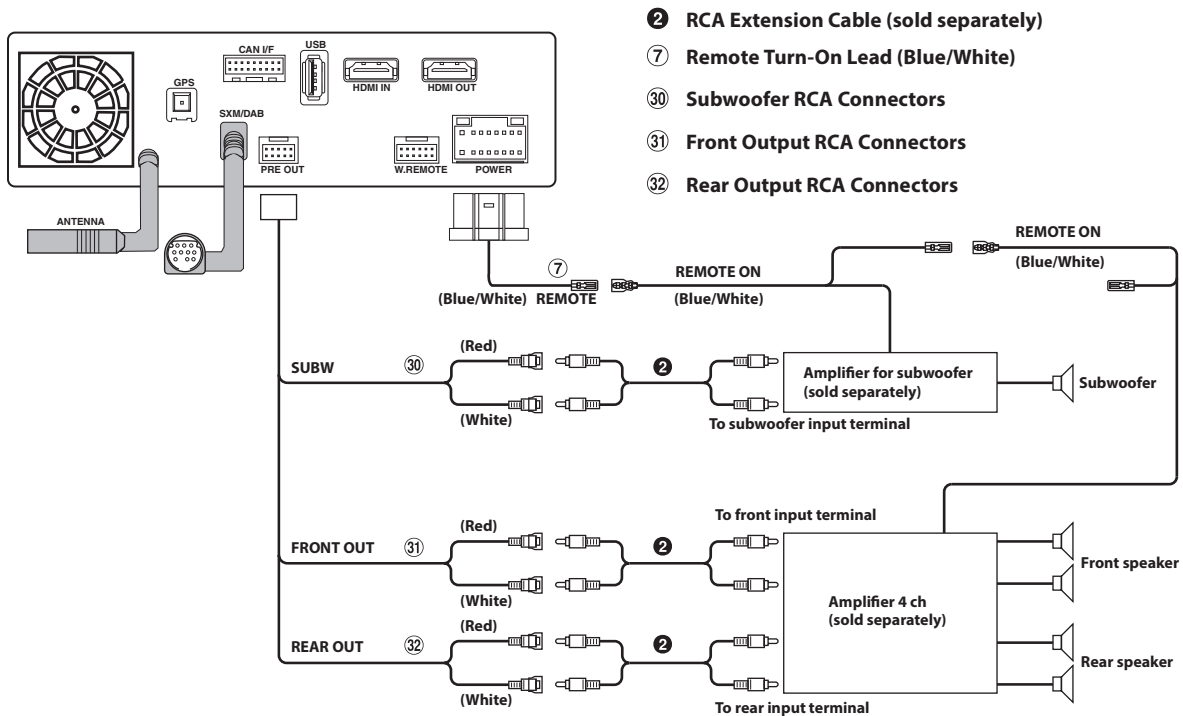

Connecting A SiriusXM Module (Sold Separately)

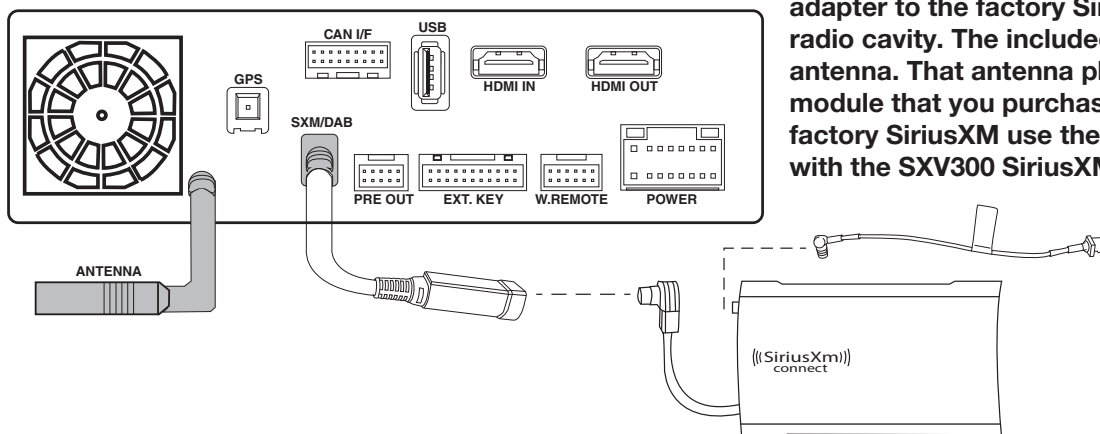

There is no way to integrate the factory SiriusXM tuner. Once the radio is removed, the factory SiriusXM is removed. As the title states, SiriusXM requires a tuner sold separately. This diagram shows how to integrate the antenna connection. For vehicles with factory SiriusXM connect the adapter to the factory SiriusXM antenna in the radio cavity. The included adapter is just for the antenna. That antenna plugs into the aftermarket module that you purchase. For vehicles without factory SiriusXM use the antenna that is included with the SXV300 SiriusXM Tuner.

HDMI Input (iPhone)

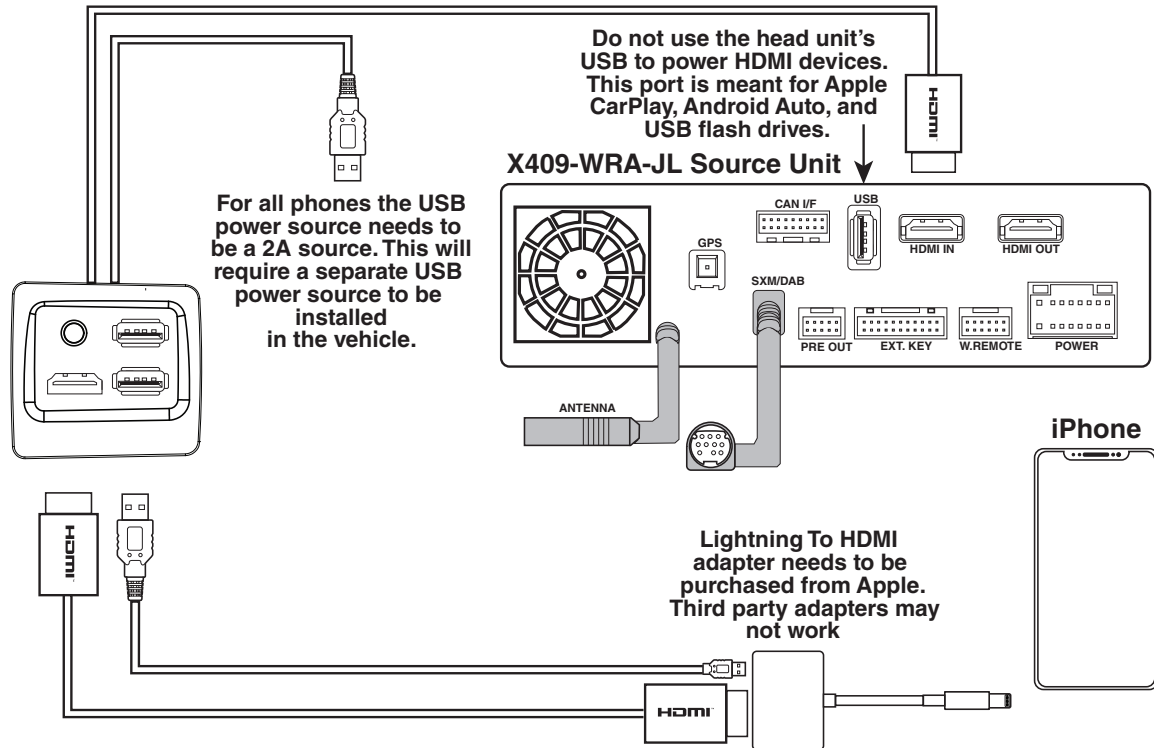

HDMI Input (Android)

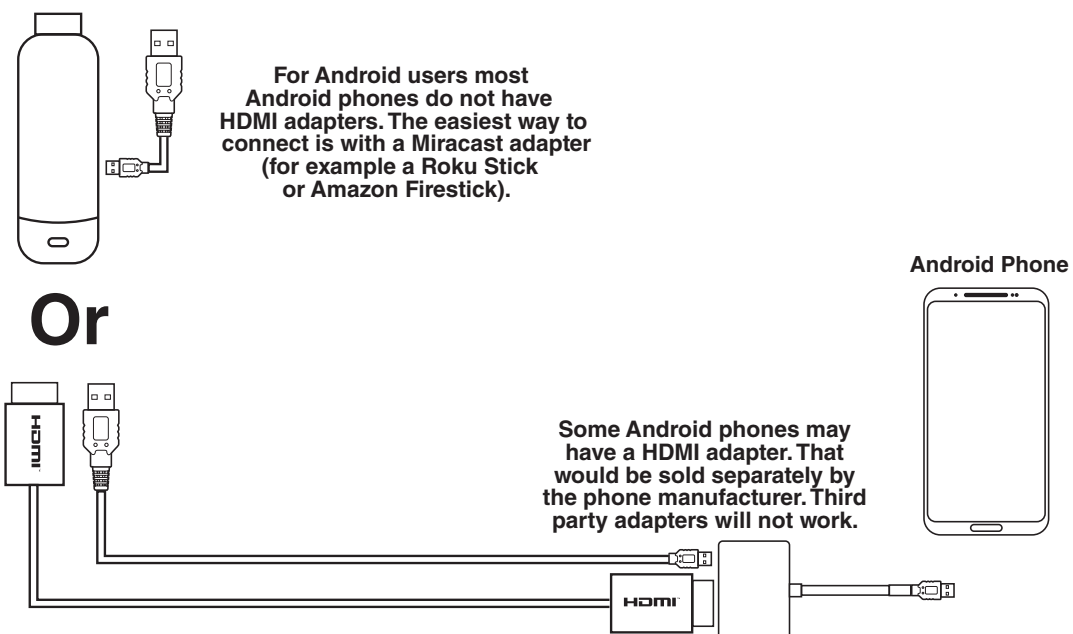

X409-WRA-JL Wiring Diagram

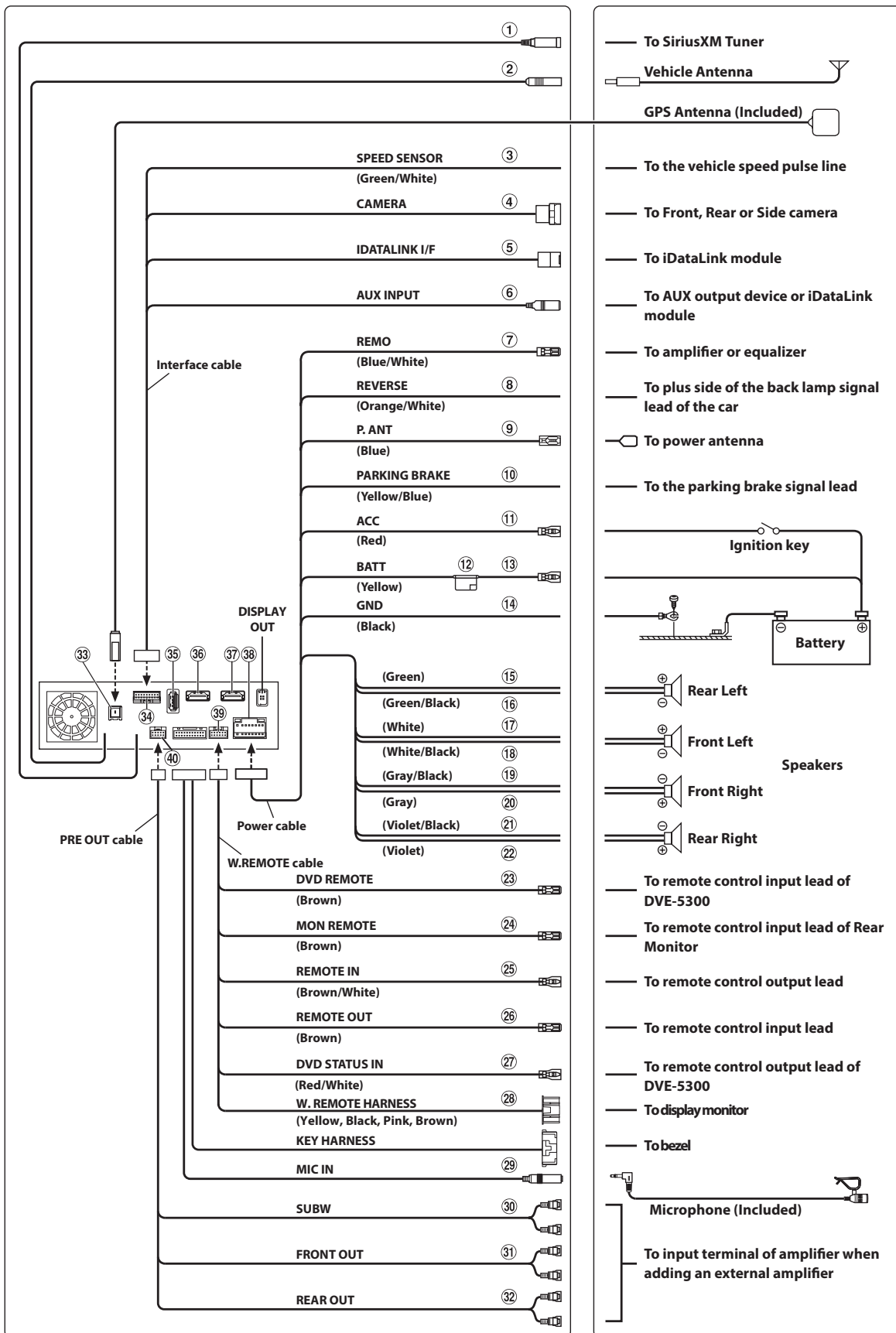

Wire Harness Pin Outs

Radio Main



Remote Harness

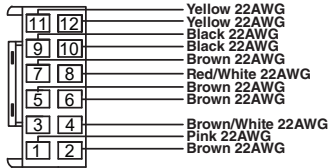

Cam Aux Data

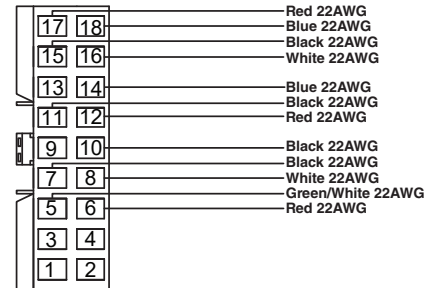

Camera Power



Direct Camera

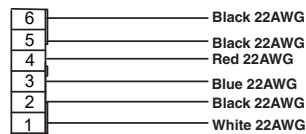

Aux Power

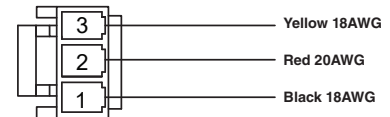

Data SWC

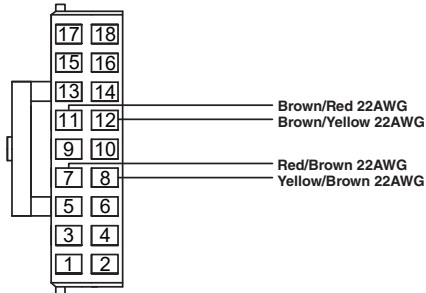

Radio I/O

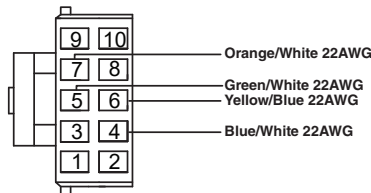

Maestro Power

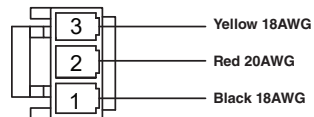

Wrangler Radio

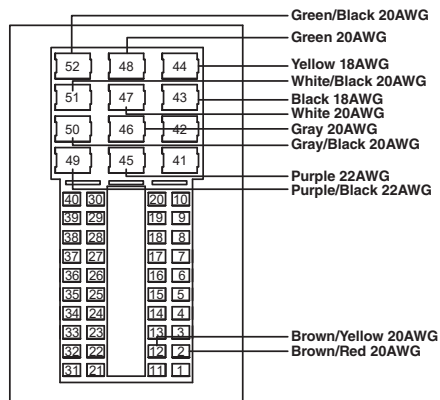

iDataLink



CAN Connector



CAN Connector



Speaker Harness

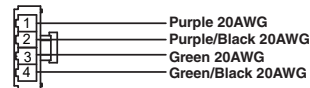

Speaker Harness



CAN



Adding The KCX-C250MC (Sold Separately)

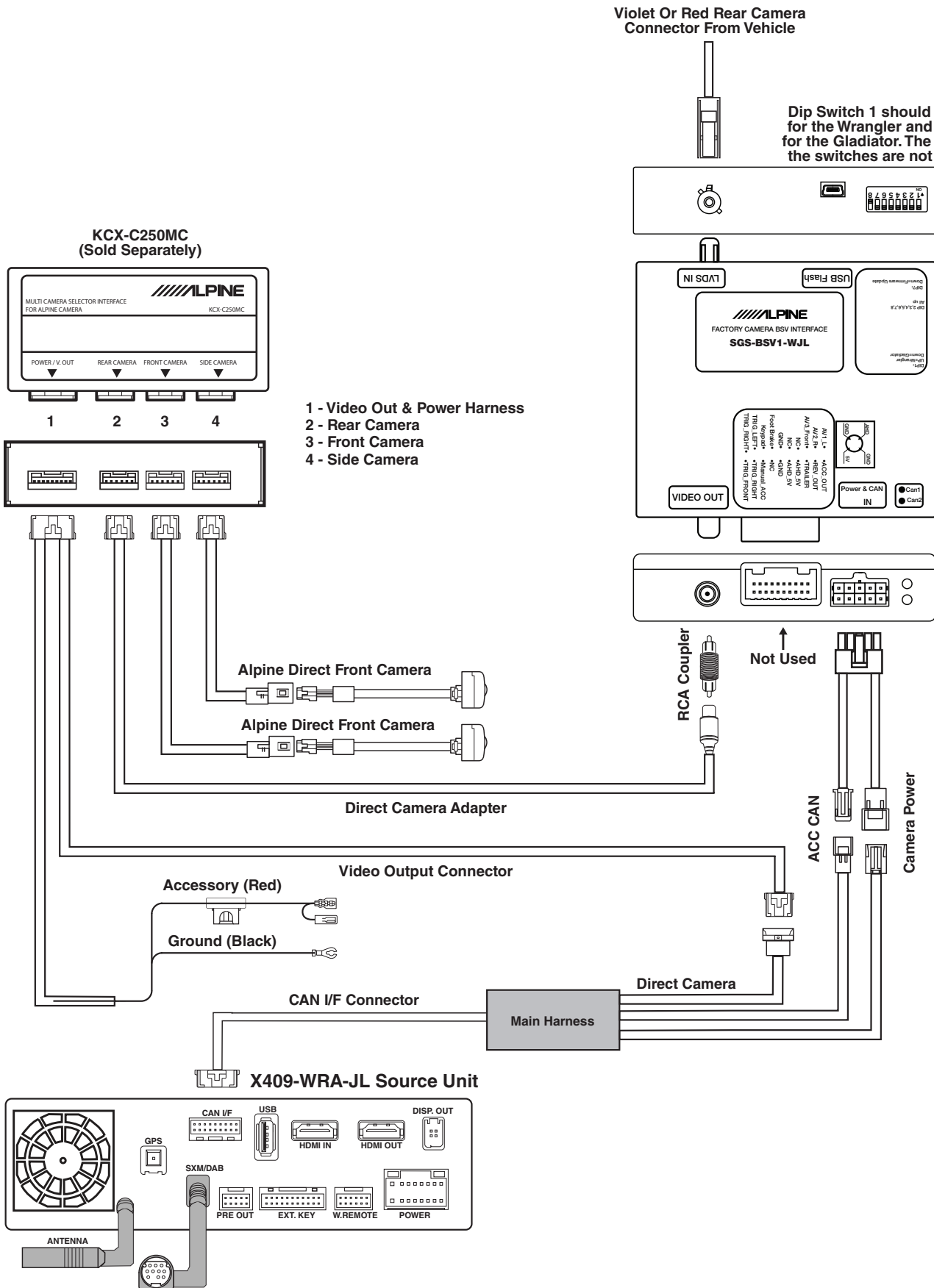

Connection Of KAC-001 (Sold Separately)

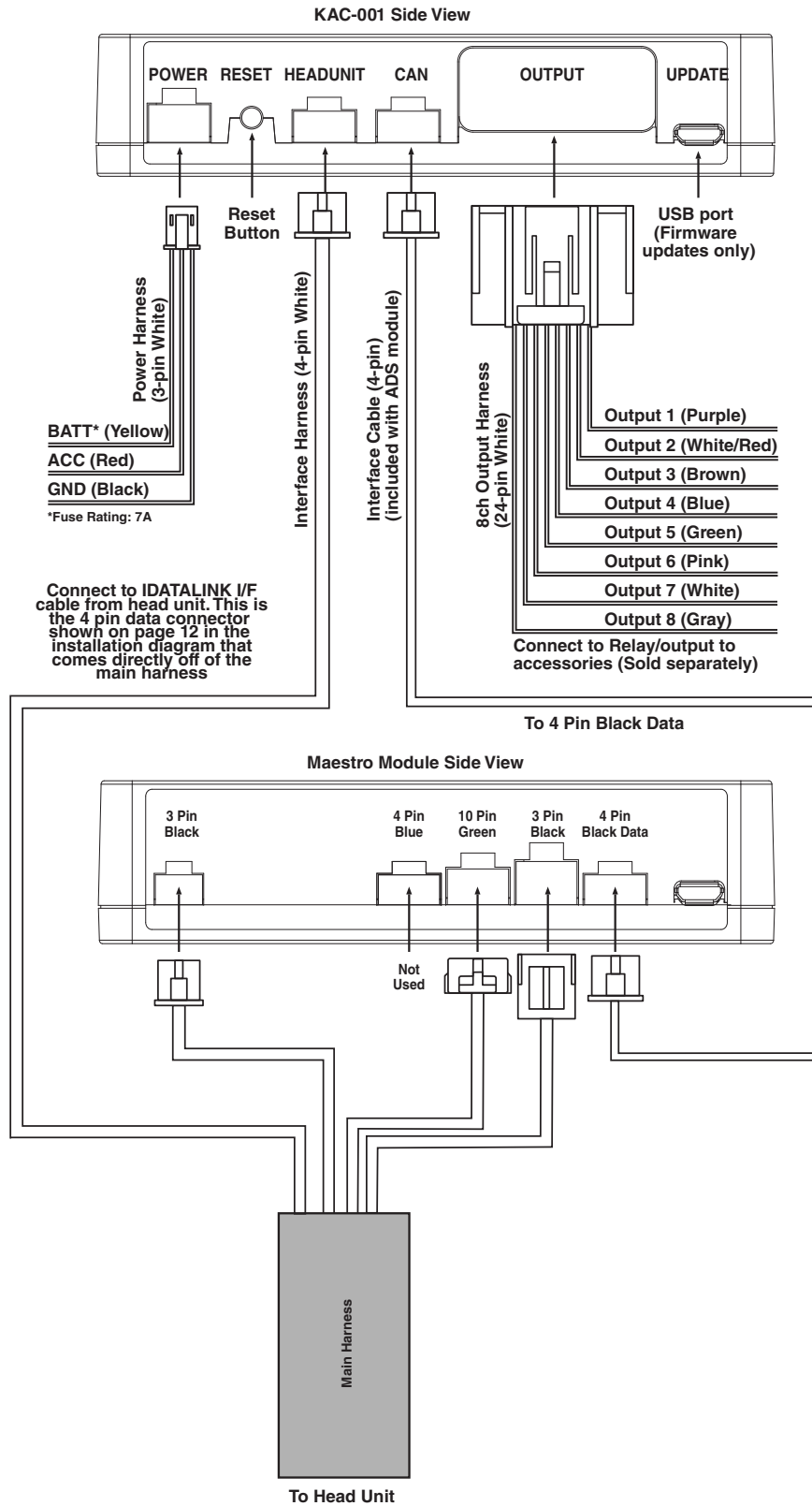

Steering Wheel Configuration

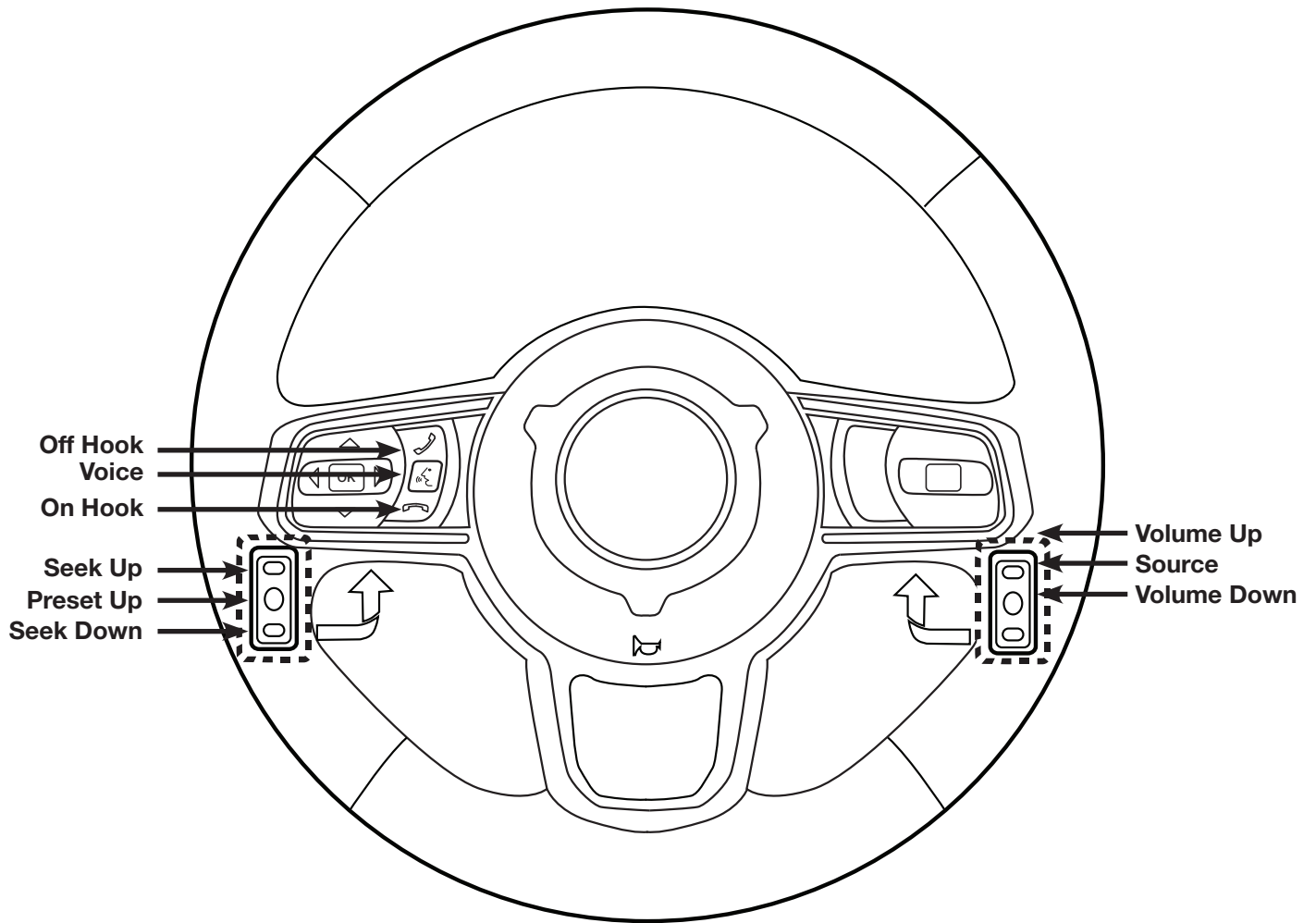

Button	Press Once	Press And Hold
Seek Up	Track +	None
Seek Down	Track -	None
Next Preset	Preset & Folder +	Preset & Folder -
Voice	Voice Or Siri	None
Off Hook	Answer Call	None
On Hook	Hang Up & Reject Call	None
Volume Up	Volume +	None
Volume Down	Volume -	Attenuation On/Off
Source	Source/Camera View	None

Setting Up OEM Aux Switches

- 1 Once in the setup menu (see page 28) select SYSTEM and then MAESTRO MODULE.
- 2 Select VEHICLE FEATURES.
- 3 Select AUX SWITCHES.
- 4 Select the switch that you would like to edit (AUX 1, AUX 2, AUX 3, or AUX 4).
- 5 Select the setting you would like to edit (TYPE, POWER SOURCE, or RECALL LAST STATE).
- 6 TYPE can be set for either LATCHING or MOMENTARY. LATCHING means that when the switch is selected it will stay on until the switch is pressed again. MOMENTARY will only keep the switch on as long as the button is held in.
- 7 RECALL LAST STATE when set to ON the state of the switch is retained across ignition cycles.
- 8 POWER SOURCE menu can be set for either BATTERY or IGNITION. BATTERY means the switch has power to it at all times. IGNITION means it has power only when the vehicle is on.

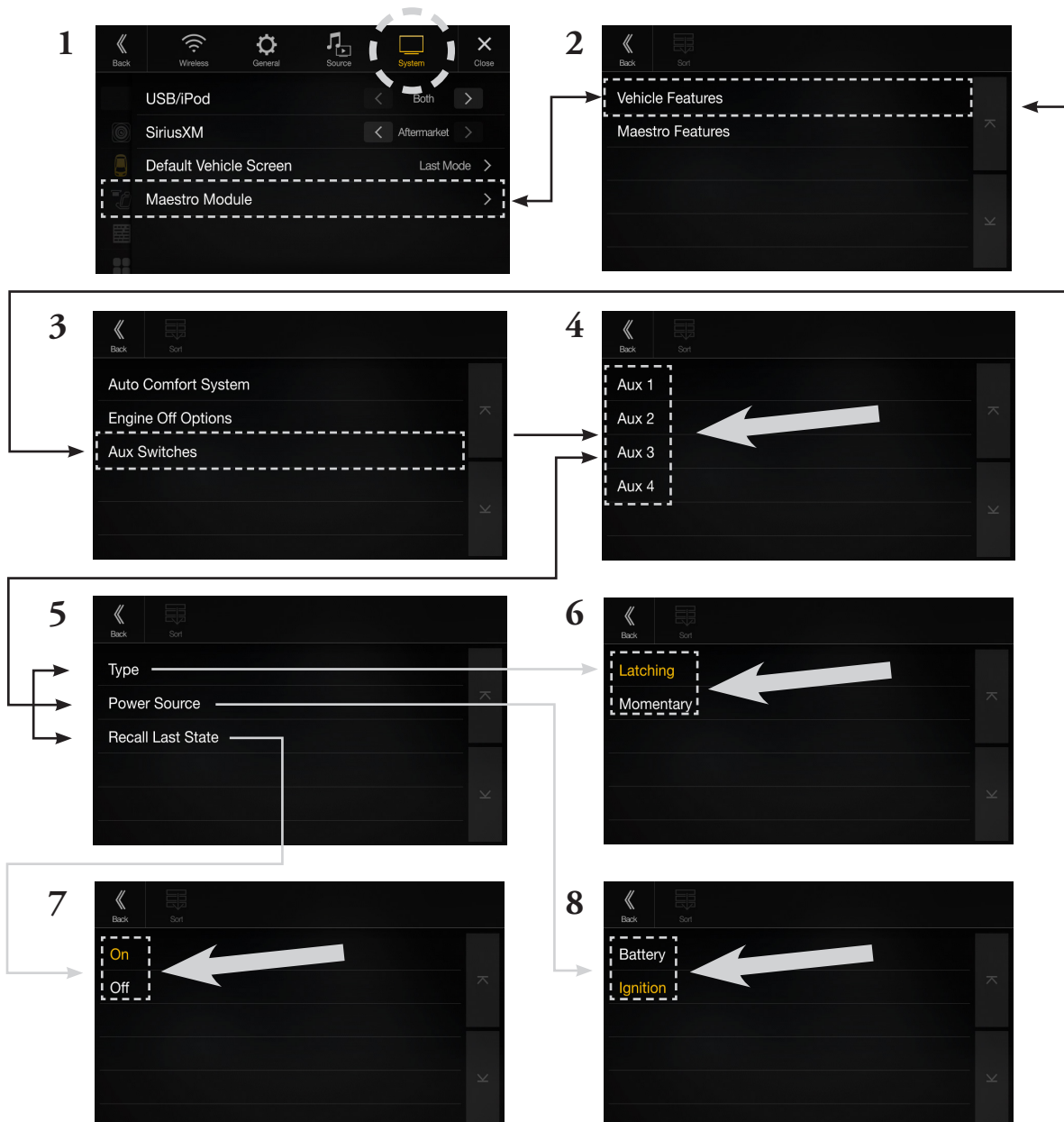

Set Up Guide

- 1 Turn the vehicle's Ignition switch to ACC.
- 2 Turn ON the X409-WRA-JL by pressing any key.
- 3 Select the user language and press OK.
- 4 **To get into the settings the parking brake sequence needs to be done.** Engage the parking brake, release the parking brake, and engage the parking brake again.
- 5 When the KAC-001 (External Accessory Control Module) is present be sure to turn it ON in the SETUP MENU. Page 96 of the owners manual goes over the details of setting it up. That can be found on the support page of the website. (MENU/SYSTEM/EXTERNAL ACCESSORIES/EXTERNAL ACCESSORY CTRLR).
- 6 When the KCX-C250MC (Multi Camera Selector Interface) is present be sure to turn it ON in the SETUP MENU. (MENU/SYSTEM/CAMERA/CAMERA SELECT/CAMERA SELECTOR).
- 7 Vehicle information- Set the desired gauge information. (MENU/VEHICLE INFO/GAUGES/CAR SETTINGS).
- 8 If the vehicle is equipped with the factory accessory switches set those up. See previous page for details. (MENU/FACTORY SYSTEM SETUP/MAESTRO MODULE/VEHICLE FEATURES/AUX SWITCHES).

Troubleshooting Guide

Symptom		Possible Cause	Remedy
1	iPhone not working with HDMI.	Not using Apple HDMI to Lightning adapter.	Purchase the HDMI to Lightning adapter directly from Apple. Not all 3rd party adapters work the same.
		Didn't plug USB power into a 2A source.	A 2A USB power source must be used to power on the device.
2	Android phone is not working with HDMI.	Using incorrect HDMI adapter.	If the phone has the feature to use an HDMI adapter it must be the one purchased from the manufacturer of the phone, not a third party adapter.
		Miracast or HDMI adapter isn't plugged into a 2A source.	A 2A USB power source must be used to power on the device.
		Miracast adapter has resolution settings that are too high.	Plug the adapter into another monitor (for example a television in the home) and reduce the resolution settings.
3	iDatalink website says serial number is invalid.	Incorrect serial number is being used.	In the X409-WRA-JL settings confirm the serial number. MENU/SETUP/GENERAL/ABOUT.
		Serial number may not be in iDatalink database.	Call ADS at 1-866-427-2999 and verify.
4	No output from RCA's	Maestro module is flashed for amplified system.	Re-flash module for non-amplified system.
5	Headunit will not turn on.	Incorrect serial number was used when flashing maestro.	Flash Maestro with correct serial number.
		4 pin Maestro data cable is disconnected or damaged.	Check for proper connection or disconnected pins.
		OBD2 cable is not plugged in.	Connect OBD2 connector to the OBD2 port.
		Monitor, key-harness or main harness are not connected.	Check for proper connection or disconnected pins.

Troubleshooting Guide Continued

Symptom		Possible Cause	Remedy
6	Cannot enter SETTINGS MENU.	Vehicle is in motion or parking brake is not engaged.	With vehicle in (P)PARK engage the parking brake. Release the parking brake and engage the parking brake a second time, as shown in the Setup Guide on page 28.
7	Sound mutes when vehicle is shifted into reverse.	Mute on reverse is turned on in the SOUND menu.	Change Mute on reverse to off.
8	Only the front speakers are on for SXM Radio.	SXM Tuner has not been activated.	Activate SXM Tuner.
9	The vehicle is incorrectly positioned on the Navigation display.	Poor GPS signal.	Ensure the recommended GPS antenna route was used. See page 17.
10	CarPlay, Android Auto, or off-road navigation map positioning issues.	GPS antenna is positioned incorrectly.	GPS antenna is obstructed and doesn't have line of sight to the sky. Perform a factory reset. The unit will automatically recalibrate.
11	CarPlay, Android Auto, or off-road navigation vehicle position icon heading in wrong direction	Reverse Signal is not connected or not reliable.	Ensure that Reverse wire is connected. Also ensure that no 3rd party interface module(s) interfere with the Reverse Signal. The head unit uses the Reverse Signal to achieve optimal positioning performance.
12	iPhone or Android phone is not recognized when connected to the USB cable.	Loose or disconnected USB cable.	Check the USB connection behind the headunit.
		Non-compatible cable.	Use the cable supplied with the iPhone or Android phone. Third party adapters and long extensions may not work. Only use USB extension that came with the head unit.
		Dirty charging port on phone.	Clean charging port.
		Wrong USB port used.	The OEM USB's are only meant for charging. They can't transfer data. The only one that can is the bottom port of the USB, AUX, HDMI interface that is included.
13	Volume controls on bezel and steering wheel controls do not work.	The setting for External Processor was turned on.	That setting should only be checked when using an external sound processor. When there isn't one being used in the audio system it needs to be in the default setting of off. MENU/SETUP/SYSTEM/EXTERNAL ACCESSORIES/EXTERNAL AUDIO PROCESSOR/OFF
14	OEM USB's not charging.	The wrong micro USB was plugged into the USB power adapter.	There are 2 factory micro USB plugs in the dash behind the media center. One is black and one is grey. If the supplied adaptor is plugged into the grey micro USB the factory USB's will not charge. Make sure the black USB is plugged into the power adapter. See pages 16 and 19 for details.