



**WARNING:**

Validate the kit contents with the component list included on this page before proceeding. This kit is intended to be used in a modified vehicle. Please read this page thoroughly and be sure that you understand everything explained on it prior to opening any of the enclosed packages, or before attempting to install any of the components. Once this kit has been opened or a component installed, the kit is not returnable.

1. This updated American Autowire wiring system **WILL NOT SUPPORT** any 1987-90 factory Jeep computerized systems (carbureted or fuel injected), and should be used in a **MODIFIED** application only. It will work with the factory Jeep Dura-Spark (harness 510824 is available at an extra cost), HEI, or other aftermarket ignition and fuel injection systems. This kit will not support the 2.5L 4 cylinder engine in stock form.
2. This kit includes the wiring to support the use of a factory heater system and/or aftermarket heater and A/C systems. This kit does not include the wiring for the factory original **A/C** system, but will support the use of a factory A/C system.
3. This kit only supports the use of a higher current, self-exciting 1-wire alternator or an internally regulated alternator. Optional adapters may be necessary for certain applications.
4. AAW **DOES NOT** support the use of an ammeter. This wiring system has been designed to work with all 1987-90 Jeep factory voltmeters.
5. This kit **IS NOT** set up with a resistance wire for a standard type ignition system. It is wired with a full 12-volt primary ignition feed. See pages 27 and 28 for the various Ignition System Wiring configurations.

510742 - Classic Update Series Kit  
1987-90 Jeep YJ

This kit contains the following components:

Bag	Part Number	Description	Quantity
G	510743	Dash Harness kit	1
H	510744	Instrument Cluster wiring kit	1
J	510745	Engine Wiring Kit	1
L	510746	Front Light wiring kit	1
M	510747	Rear Body Wiring kit	1
	510748	Fuse, Relay, and Flasher kit	1
	510476	Alternator and Main Power Conn. kit	1
	510730	VSS Lead Wires	1
	500919	Practice Terminal Crimping set	1

Validate the kit contents with this component list. If there are any discrepancies with incorrect or missing parts, stop your installation and notify the supplier you purchased the kit from before proceeding.

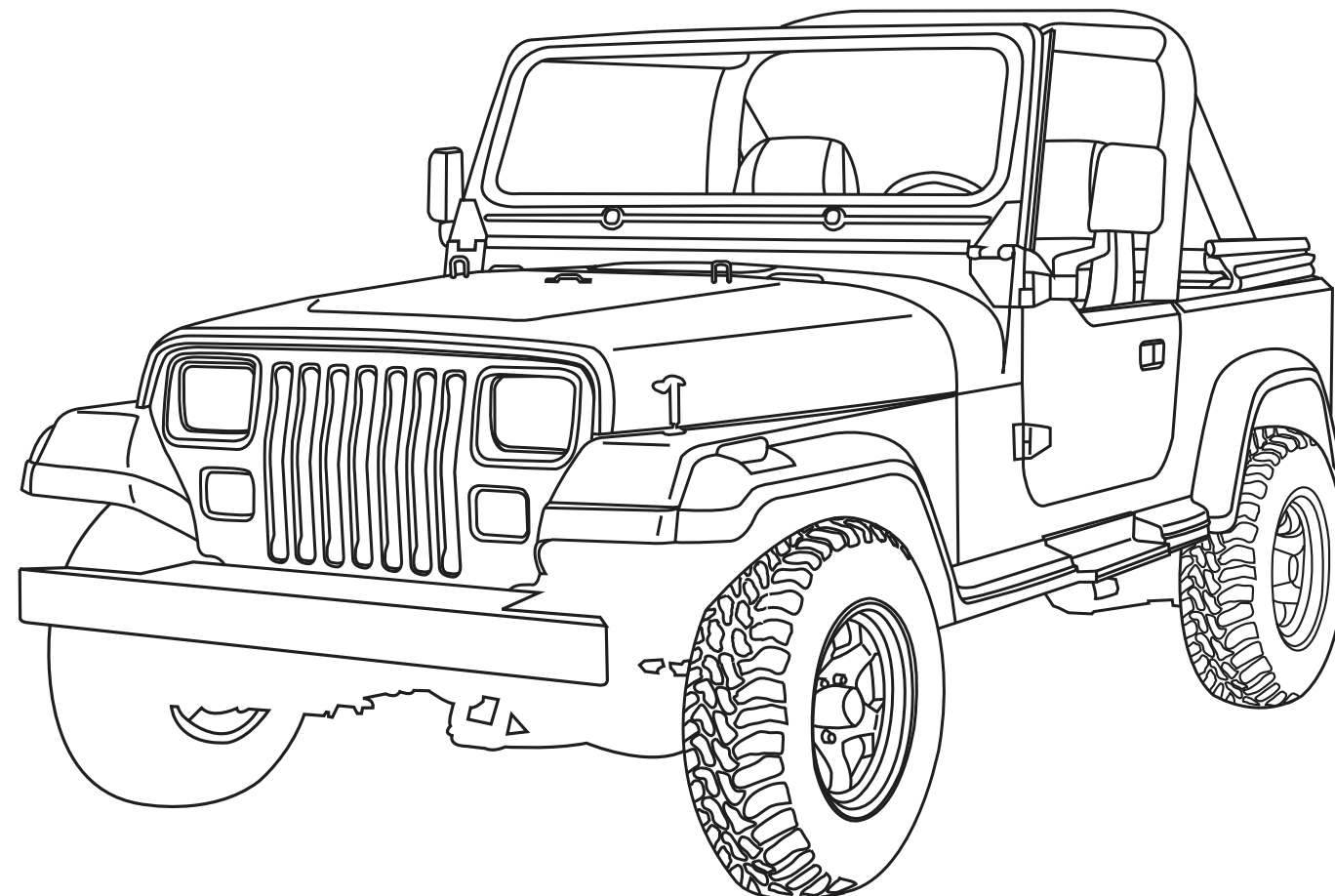

**510742 1987-90 Jeep YJ**  
**Instructions**  
*Classic Update Series*



© COPYRIGHT 2004 American Autowire / Factory-Fit  
Used with express permission of  
American Autowire / Factory-Fit

# START HERE !

## PLEASE READ THIS BEFORE STARTING INSTALLATION !

This wiring kit is designed for ease of installation. Please read the guidelines below BEFORE STARTING installation to guarantee a successful job. Use an appropriate crimping tool, which folds the wings of the open barrel terminals down into the wire, as shown on this page. If you use our crimping tools and correctly crimp the included terminals, soldering is not necessary. If you are unsure about a particular crimp, soldering is recommended. Our factory crimped terminations are installed by GM approved five ton presses, and soldering these terminations is not necessary.



AAW offers a great terminal crimping video entitled Proper Crimping Video . It can be viewed by visiting YouTube.

Type the following address into your web browser, to go directly to the video:  
[www.youtube.com/watch?v=JAgEDoVI-co](http://www.youtube.com/watch?v=JAgEDoVI-co)

Youtube Channel:  
[www.youtube.com/user/WiringHarness](http://www.youtube.com/user/WiringHarness)



We carry many accessories for your 1987-90 Jeep YJ:



p/n 510807  
1990 Optional Jeep YJ  
Rear Wiper Harness



p/n 510797  
87-90 Optional Jeep YJ  
Rear Defroster Harness



p/n 10014885  
87-90 Optional Rear  
Defroster Relay/Timer



p/n 510824  
87-90 Optional Jeep YJ  
Duraspark Harness

The terminals that we supply in our kits, utilize what is known as an F crimp. The F crimp, in a cross section, will look like the illustration below, when done correctly.

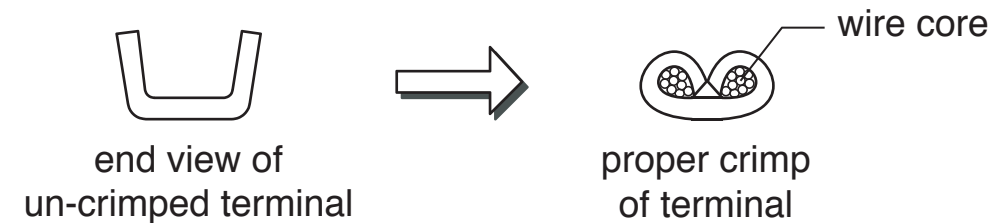

We carry the following crimping hand tools, to help with your terminal crimping. These hand tools are available, for purchase or rental.

p/n 510585  
OEM small gauge terminal crimping tool



p/n 510586  
OEM large gauge terminal and double small gauge terminal crimping tool



p/n 510587  
Includes Both terminal crimping tools

p/n 510609  
OEM sealed connector crimping tool (18-12 gauge)



If you have any questions concerning this or any of our products, please feel free to call us at 1-856-933-0801.

**1987-90 Jeep YJ**  
**510742**

*Classic Update Series*

92972617 Rev 0.0 8/19/2020



## Table of Contents:

**Bags: Pages: Sections:**

	4-5	<b><u>Fuse, Circuit Breaker, Relay and Flasher (510748) Placement, and Fuseblock/Bulkhead installation</u></b>		
G	6-14	<b><u>Dash Harness (510743) (Installation)</u></b> – This is the main harness in the kit and it should be installed first. It can be installed to the dash frame assembly with the unit out of the vehicle, or routed behind the dash frame with the frame still in the vehicle. This harness connects to:		
		Accessory Power Feed connector	LH and RH Courtesy Lights	Heater Switch On/Off Micro Switch
		Park Brake Switch	Tachometer	Cigar Lighter
		Rear Body Harness	Grounds	Original A/C Harness (with modifications)
		LH & RH Door Jamb Switches	Wiper Switch	Fog Lamp Switch
		Horn Relay	Wiper Motor	Dash Light Candelabra (optional lamp use)
		Fog Lamp Relays	Ignition Switch	Instrument Cluster Harness
		Headlamp Dimmer Switch	Turn Signal Switch	Heater/Blower Motor Switch
		Headlight Switch	Stop Light Switch	Heater/Blower Motor Resistor
		LH and RH Indicator Light	Various Dash Illumination Lights	Radio
		I/P Dimmer Switch	Heater Panel Light	Electric Speedometer Extension and Ground
H	15-16	<b><u>Gauge Cluster Harness (510744)</u></b> – This harness is assembled by the customer and connects to:		
		Printed Circuit Board (PCB)	Dash Harness	
	17	<b><u>Aftermarket Gauges:</u></b>		
		All gauges (Volts, Fuel, Speedo, Oil, Temp, Tach)		
J	18-28	<b><u>Engine Harness (510745)</u></b> – This harness connects to the Dash harness and the:		
		4wd Switch	Power Accessory (Lead Wire)	Tachometer Signal
		Neutral Safety and Back Up Switches	Starter Relay/Solenoid	Oil Pressure and Engine Temperature Senders
		The Assembled Mega Fuses	Ignition System	Blower Motor
		A/C Compressor and Low Pressure Switch	Electric Choke	
L	29-32	<b><u>Front Light Harness (510746)</u></b> - This harness connects to the Dash harness and the:		
		LH & RH Headlights	LH & RH Side Markers	Fog Lamps
		LH & RH Parking/Turn Lamps	Washer Pump/Reservoir	Horns
		Brake Warning Switch	Electric Fan Trigger Feed	Provides an In-Line Courtesy Lamp Disconnect Feature
M	33-37	<b><u>Rear Body Harness (510747)</u></b> – Interior and exterior connections. This harness connects to the Dash harness and the:		
		Original Hardtop Harness Dome Light Wires	Fuel Tank Sender, Pump and Ground Leads and Extensions	
		Tail Light Extensions (Stop, Tail and Back Up)	Third Brake Light	
		Original Hardtop Harness Rear Defroster Wires		



**American  
Autowire**

www.americanautowire.com 856-933-0801

**1987-90 Jeep YJ**

**510742**

*Classic Update Series*

92972617 Rev 0.0 8/19/2020



# Fuse Block and Bulkhead installation instructions:

**NOTE:** Prior to installing the Dash harness into the vehicle, obtain the Fuse, Flasher, and Relay Kit, **510748**, and plug all of the fuses, wiper circuit breaker and flashers into the Fuse Block (see below). Also, plug the Horn Relay and Fog Lamp Relays into the relay bases (see page 7) on the dash harness.

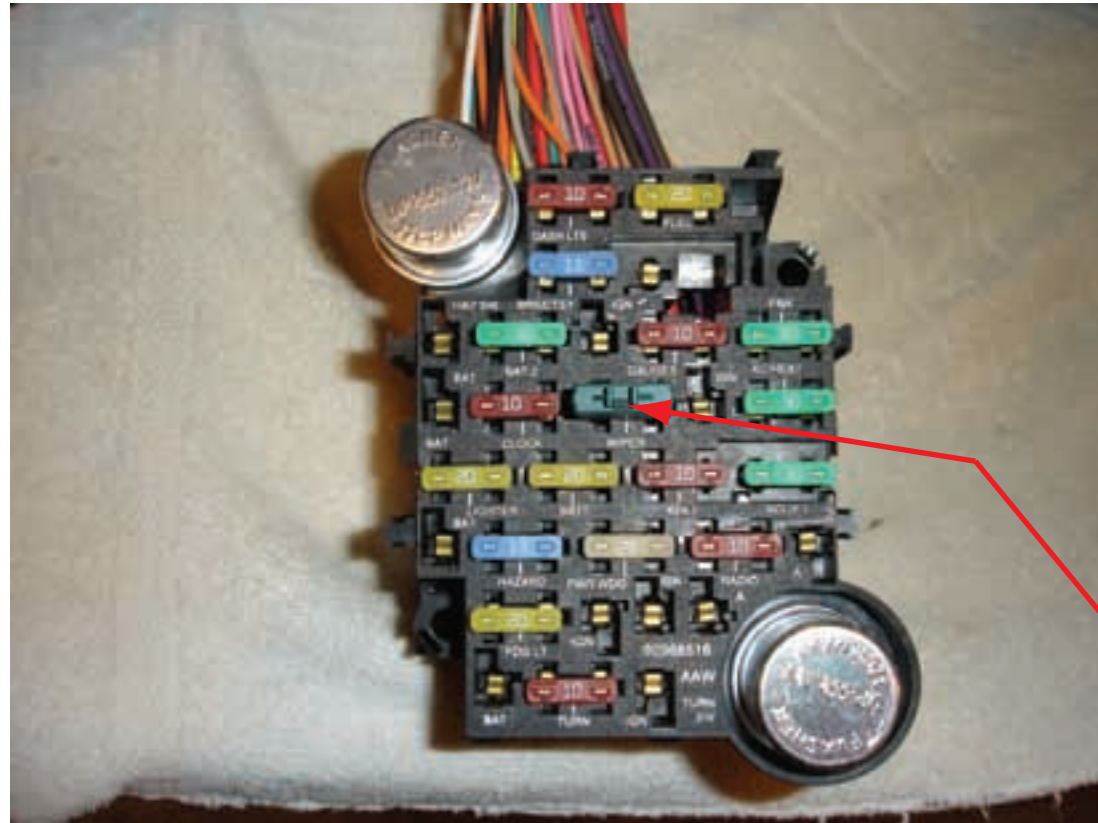

Assembled fuse block with fuses, flashers and circuit breaker installed.

Fuse usage details. **NOTE:** Head lights are protected by the H/L switch internal 25A breaker

Fuse #	Fuse Block Printing	Fuse Rating	System Wiring Protected
1	DASH LTS	10A	Cluster lights, Tachometer Lights, Speedometer Lights, PRNDL light, Fog Light Switch Illumination Light, optional dash lights plugged into candelabra, Rear Defogger Illumination Light, Rear Wiper Switch Illumination Light, Heater Control Panel Light
2	FUEL	20A	Electric fuel pump, Ignition feed for electric speedo (Accy 6-way conn).
3	BRK/CTSY	15A	Stop and third brake lights, under dash courtesy lights, dome light (Hard Top), hood light, Fog Light Relay Coil, Rear Running Lights, Front Park Lights.
4	BAT 2	30A	B+ feed to rear window defogger module (optional kit).
5	GAUGES	10A	Gauges (Temp, Fuel, Oil Pressure and Voltmeter). B+ for options as tachometer 4x4 Light, Back-up Lights, Brake Warning Light
6	FAN	30A	Electric fan
7	CLOCK	10A	Battery feed for clock, radio battery feed
8	WIPER	<b>6A CB</b>	Wiper motor, Front windshield washer pump (See below for CB details)
9	AC/HEAT	30A	Heater Micro Switch and Heater Switch
10	LIGHTER	20A	Cigar Lighter
11	BAT 1	20A	B+ Feed to the Rear Wiper Motor for park and Rear Power Outlet
12	IGN 1	10A	Electric choke
13	ACCY 1	30A	Feed for accessory and rear defogger control circuit (Accy 6-way conn).
14	HAZARD	15A	Hazard lights
15	PWR WDO	25A	Rear Wiper Motor for Hard Top (optional kit) Rear Window Washer Pump for Hard Top (option kit) Ignition Feed for options (Accy 6-way connector)
16	RADIO	10A	Accessory feed On-off for the radio
17	FOG LT	20A	Fog lamp feed
18	TURN	10A	Turn signal

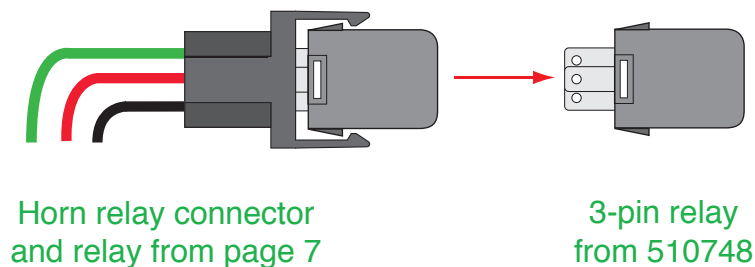
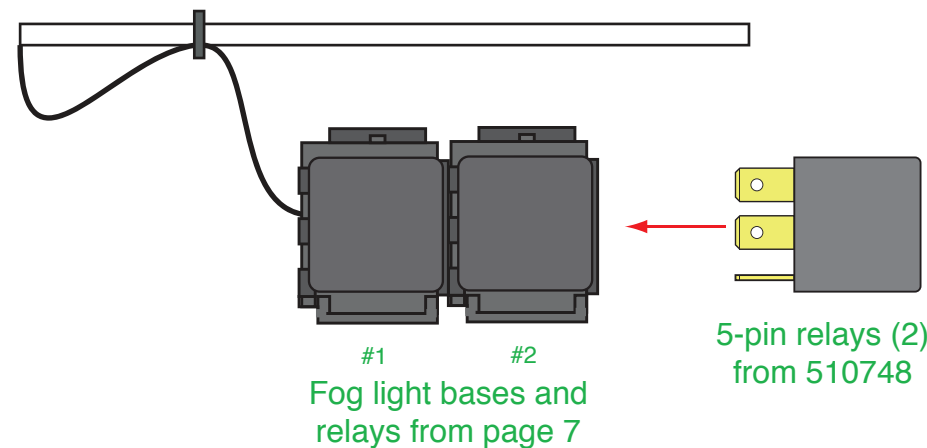

**NOTE:** Your new dash harness has a manually re-settable, 6 amp, circuit breaker protecting the wiper circuit. In the event that your circuit breaker trips due to an ice build-up or other reason, the black tab on the breaker (red arrow as shown left and right) will pop out on the breaker. After clearing the issue that caused the breaker to trip, simply turn the vehicle off, wait about 3-4 minutes, push the tab back in to reset the breaker, and your circuit and motor should become operational again.



6 amp circuit breaker for wiper circuit



www.americanautowire.com 856-933-0801

**1987-90 Jeep YJ**  
**510742**  
*Classic Update Series*

92972617 Rev 0.0 8/19/2020

# Fuse Block and Bulkhead installation instructions:

## STEP 1: DISCONNECT YOUR BATTERY

Disconnect the battery before installing the wiring kit. This is to prevent any accidental shorting caused by bare wire ends.

## STEP 2: LOAD THE FUSE BLOCK

Prior to installing the Dash harness to the dash, obtain the Fuse, Flasher, and Relay Kit **510748** and plug all of the fuses, wiper circuit breaker and flashers into the Fuse Block. Also, plug the Horn Relay and Fog Lamp Relays into the Dash harness. (See page 4)

## STEP 3: PREPARING TO INSTALL THE DASH HARNESS

The Dash Harness routing will be the same as the original factory Instrument Panel Wiring Harness routing. Be sure to duplicate this routing.

## STEP 4: RECLAIM SOME OF YOUR ORIGINAL DASH PANEL ILLUMINATION LAMPS

See pages 10, 11 and 12 for details.

## STEP 5: START INSTALLING THE KIT

This kit is divided into individual sections that are identified by a letter printed on the sheets enclosed in each bag. The order of installation and the pages with their installation instructions are shown on page 3.

**NOTE:** There are several weather-proof connectors used in this kit. Below are detailed images of how to assemble and crimp the seals and terminals used in those connectors. Step 1 shows loading seal onto the wire before crimping. Step 2 shows the seal and wire loaded into the terminal with the proper orientation. Step 3 shows what a properly crimped terminal looks like assembled onto the wire and seal (See pages 25, 30 and 35 for details).

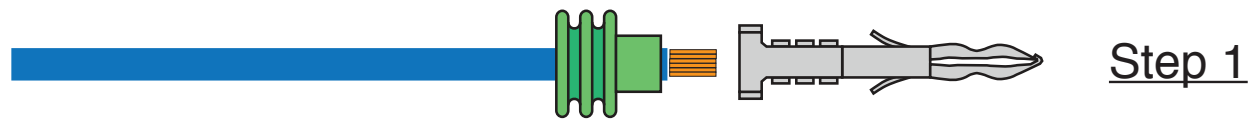

### Fuse Block and Bulkhead Attachment

Locate the original factory fuse block/bulkhead opening and mounting holes in the upper left hand corner of the firewall. You will have to open up the two mounting holes to allow clearance for the provided 1/4" X 20 X 3" bolts. Drill out the two holes using a 1/4" drill bit. Attach the fuse block and bulkhead assembly to the firewall using the bolts, washers and nuts "Q" found on page 6. (See figure A below for details)

## INSTALLING THE FUSE BLOCK AND BULKHEAD ASSEMBLY

FIGURE "A"

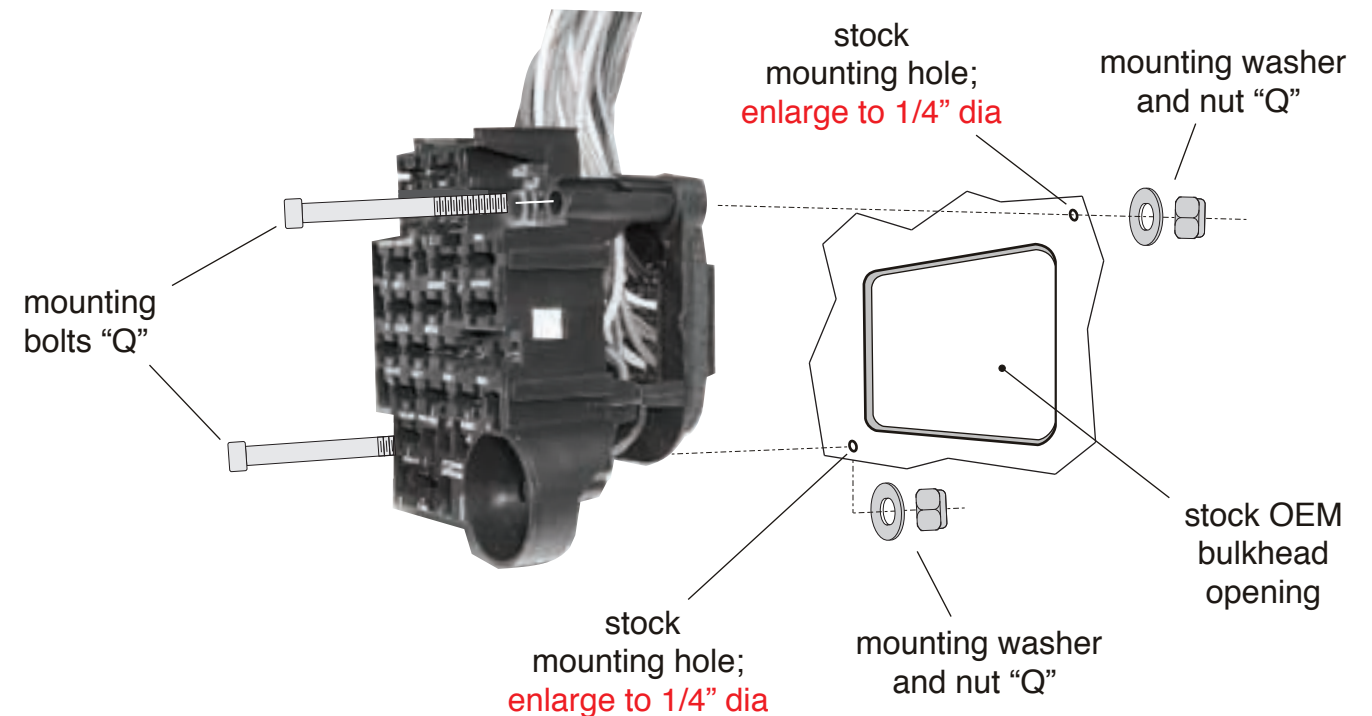

www.americanautowire.com 856-933-0801

**1987-90 Jeep YJ**  
**510742**

*Classic Update Series*

92972617 Rev 0.0 8/19/2020

# 510743 Dash/Main harness installation instructions:

Below are the supplied misc. terminals, connector bodies and assorted components included in the 510743 Dash Harness and Loose Piece bags. These will be used to complete your Dash Harness connections and are referred by the letters and descriptions below from this point forward.

**1987-90 Jeep YJ**  
**510742**  
*Classic Update Series*  
 92972617 Rev 0.0 8/19/2020



www.americanautowire.com 856-933-0801

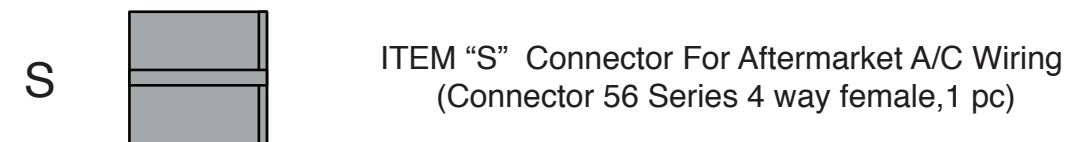
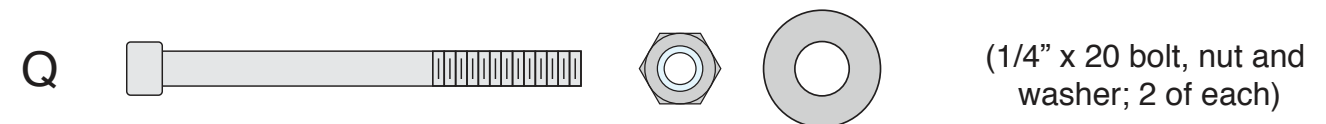
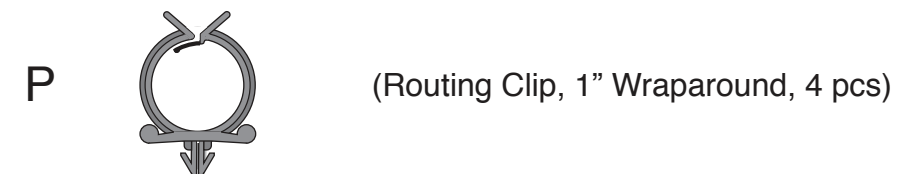
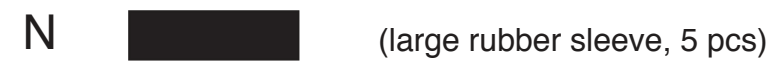
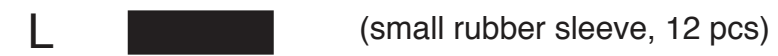
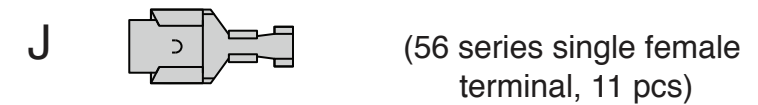
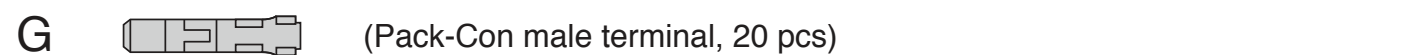
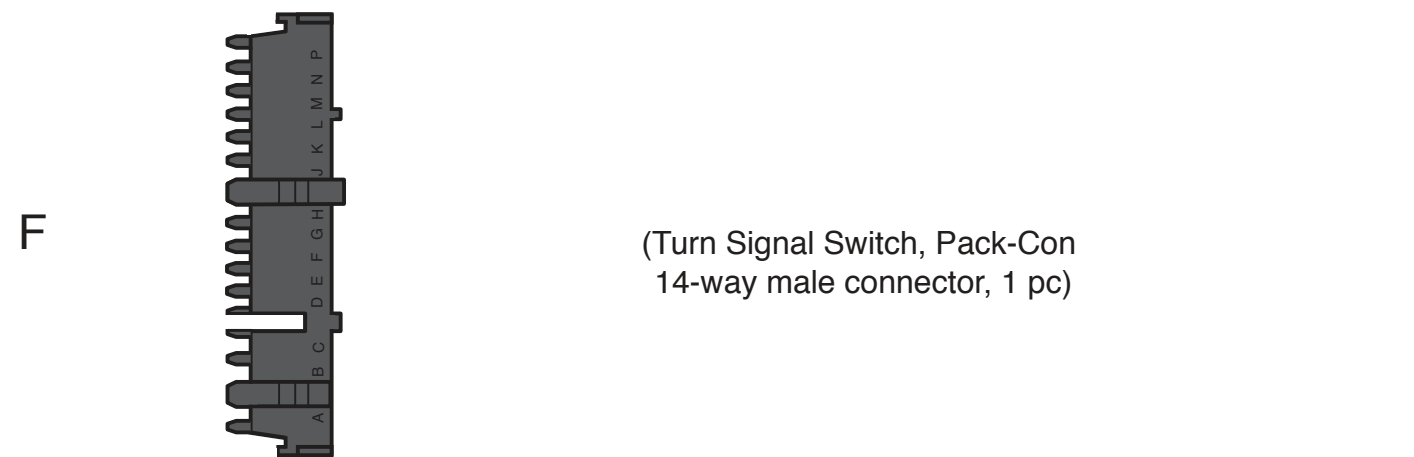
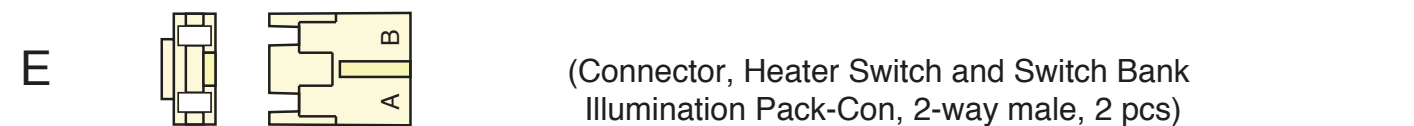
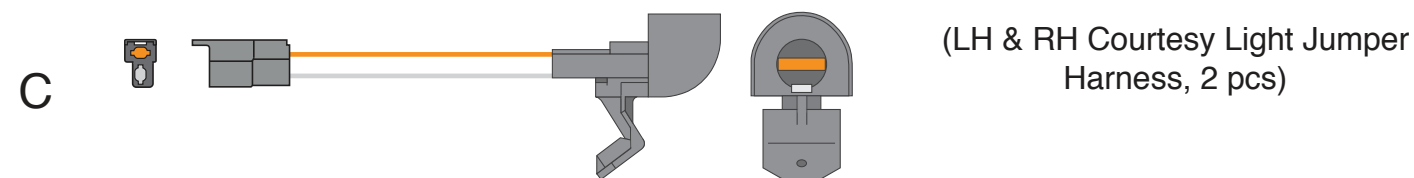
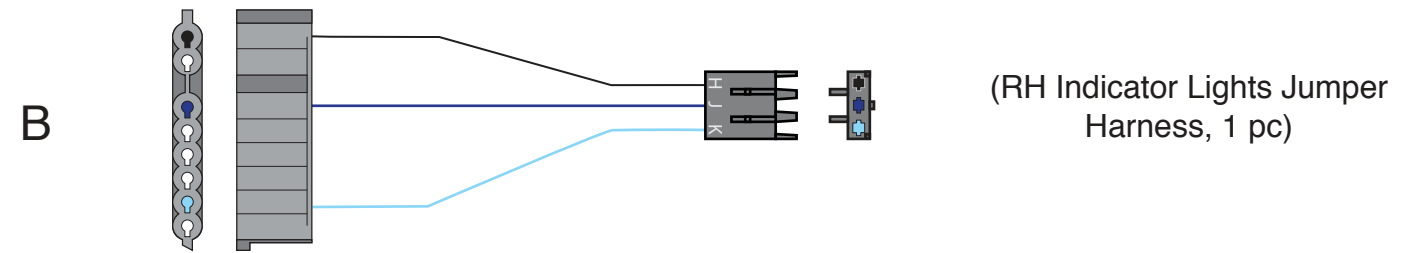
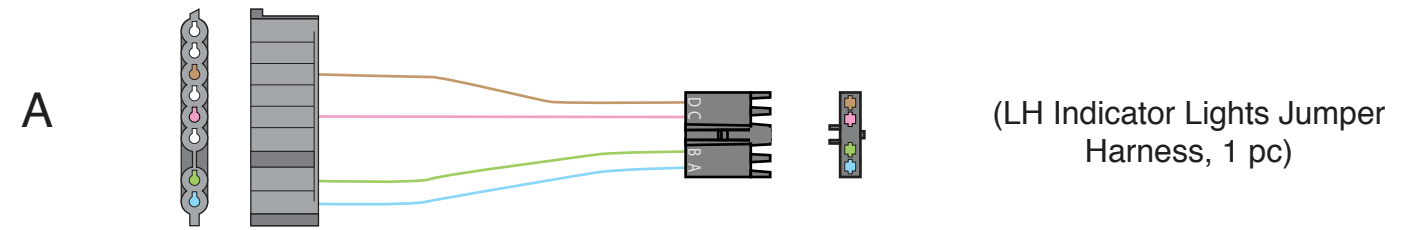



# 510743 Dash/Main harness installation instructions:



www.americanautowire.com 856-933-0801

**HELPFUL HINT:** If you have purchased the optional 510797 Rear Defroster, or 510807 Rear Wiper Harness kits, they will plug into the Accessory Connector. To make the installation of you new kit easier, please install them prior to reassembling all the componenets that make up your dashboard assembly.

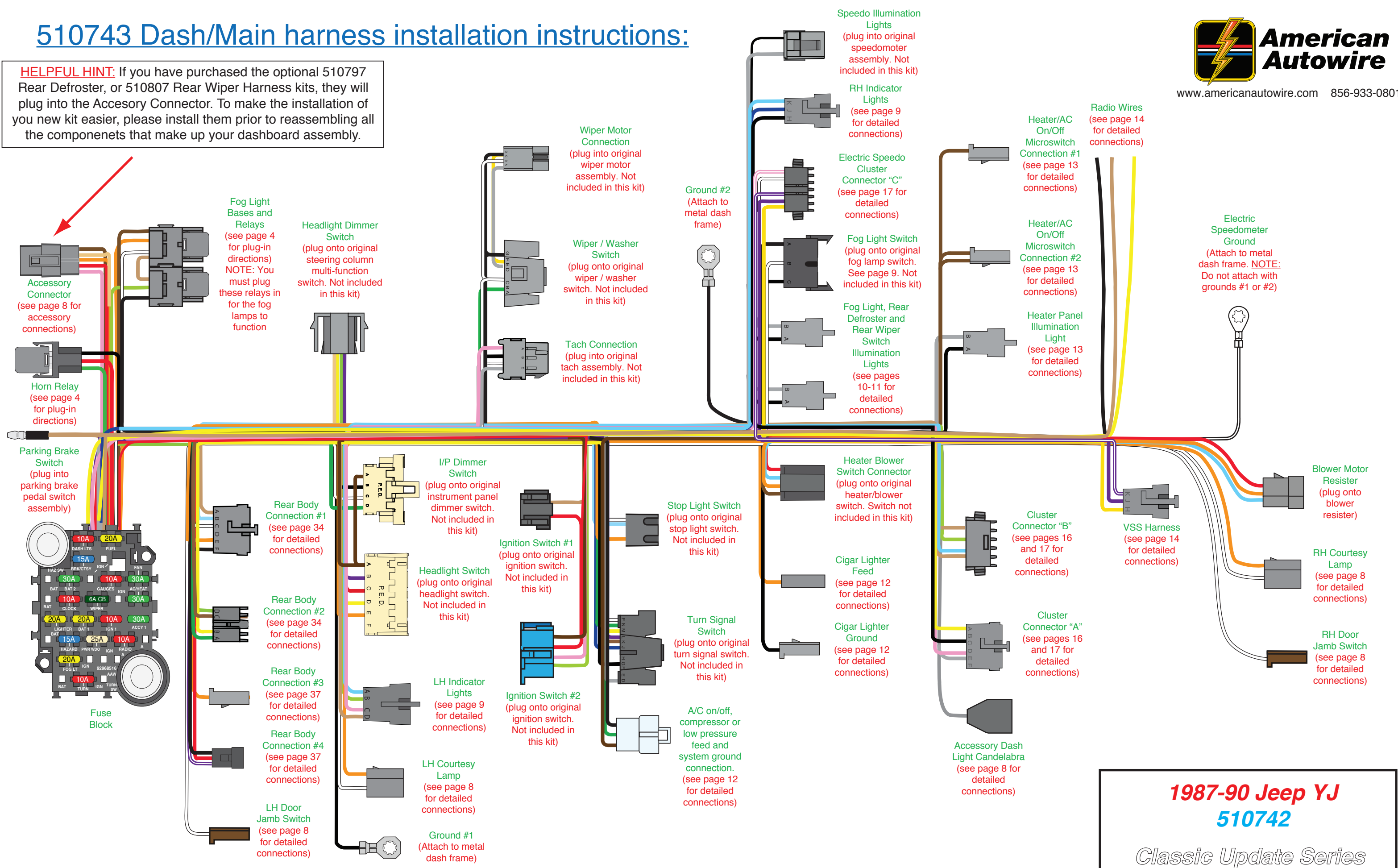

**1987-90 Jeep YJ**  
**510742**  
 Classic Update Series  
 92972617 Rev 0.0 8/19/2020

# 510743 Dash/Main harness installation instructions:

## Underdash courtesy lamp and doorjamb switch instructions:

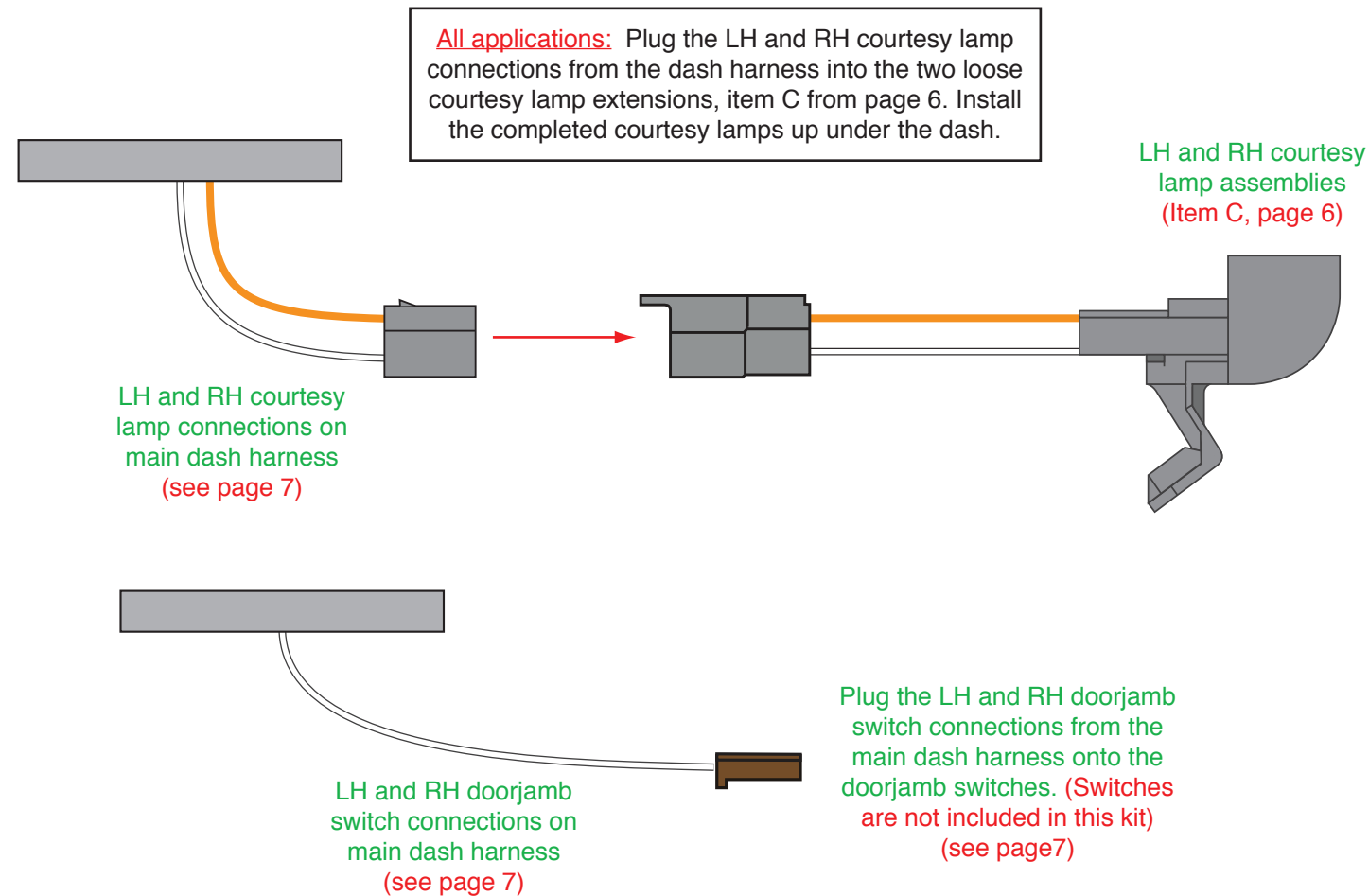

## Accessory dash light candelabra instructions:

**All applications:** We have provided an accessory dash light candelabra on the dash harness (see page 7) that can be used to add additional dash illumination lights to things like underdash gauges, radio lamp, etc. We have also provided a dash lights jumper harness (item D from page 6) that you can use to create some wire extensions to your items. Cut the jumper harness D as needed, then splice the other end of jumper D to your item. In the event that the wire leads on your items are already long enough to reach the candelabra, we have also provided loose piece terminals K and sleeves L in the dash loose piece parts kit, 92972622, that can be applied to your wires. Simply slide the sleeve L onto your wire, crimp terminal K onto the wire, then slide sleeve L up over the crimped area of terminal K so that it looks like jumper harness D. Once complete, plug the male bullet terminals directly into the candelabra to complete your accessory lighting circuits. See the illustration at right for details.

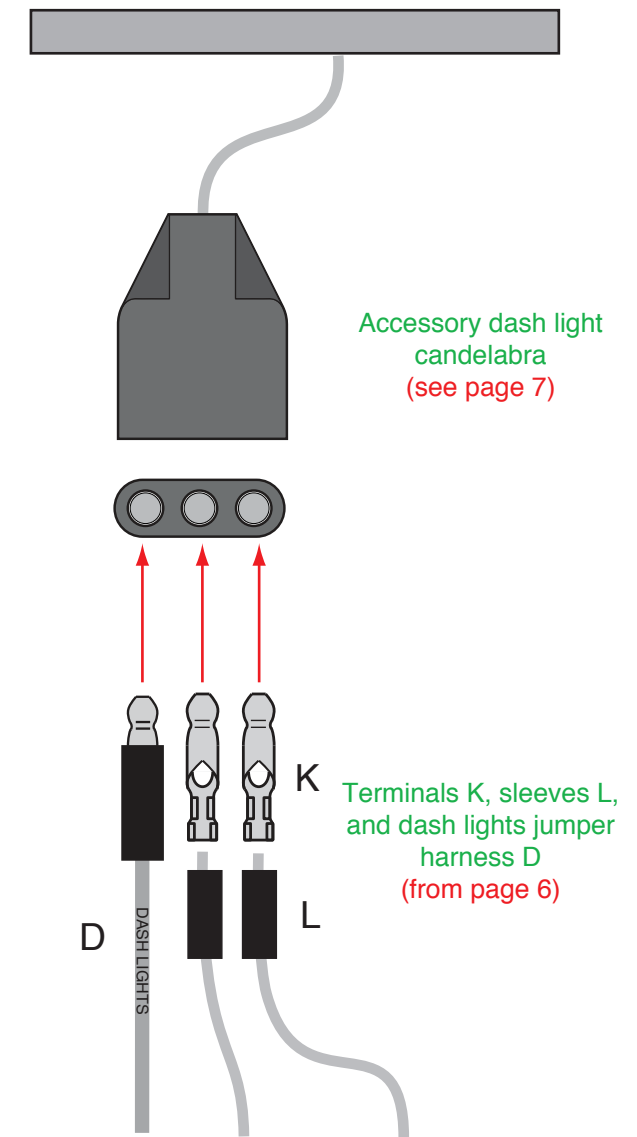

**HELPFUL HINT:** If you have purchased the optional 510797 Rear Defroster, or 510807 Rear Wiper Harness kits, they will plug into this connection. To make the installation of you new kit easier, please install them prior to reassembling all the componenets that make up your dashboard assembly.

## Accessory Connector:

Use the provided 6-way empty connector, which is attached to the 6-way Accessory connector on the Dash Harness, and terminals "H" and "J" (see Parts Kit 92972622) to add power wires for the following optional systems:

Wire Color	Wire Printing	Fuse Block Printing	Fuse rating	Description
Tan	FUEL PUMP	FUEL	20A	Fused 12 volt IGNITION feed for an electric fuel pump (may also be used to feed power to another ignition circuit).
Orange	12V BATTERY FUSED	BAT2	30A	Fused 12 volt BATTERY feed for rear window defroster (may also be used to feed power to another battery circuit).
Red	(no printing)	BAT1	20A	Fused 12 volt BATTERY feed for rear wiper motor park (may also be used to feed power to another battery circuit).
Pink	12V IGNITION FEED	PWO WDO	25A	Fused 12 volt IGNITION feed for rear wiper/washer (may also be used to feed power to another ignition circuit).
Brown	IGNITION SW ACCY	ACCY1	30A	Fused 12 volt ACCY. feed for rear defroster control (may also be used to feed power to another accessory circuit).



www.americanautowire.com 856-933-0801

**1987-90 Jeep YJ**  
**510742**  
*Classic Update Series*  
 92972617 Rev 0.0 8/19/2020



# 510743 Dash/Main harness installation instructions:

## LH and RH turn signal indicator, high beam, 4x4 and brake warning indicator lamp instructions:



LH indicator lamp extension, Item A, is shown above with the dash insert flipped down and the extension plugged onto the circuit board pins along with the mating end of the extension plugged into the dash connection.

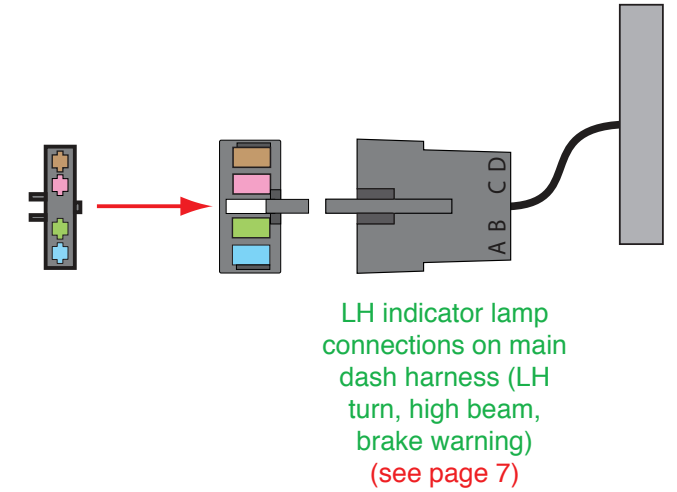
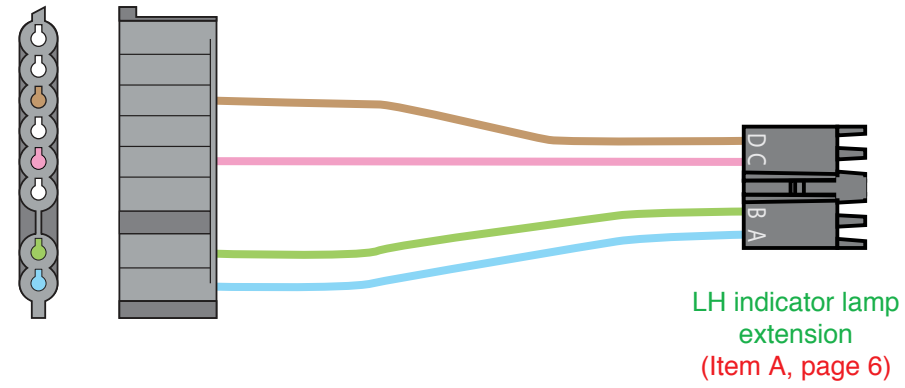

NOTE: shown here is the optional rear wiper/washer switch connection.  
(available separately, 510807, see page 1)

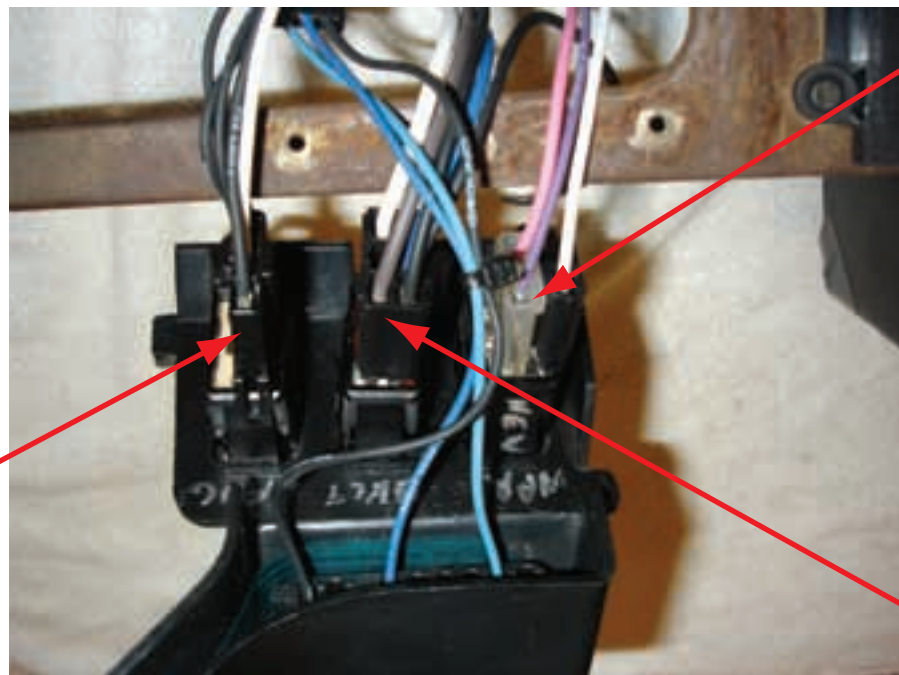

fog lamp switch  
(see page 7)

RH indicator lamp extension, Item B, is shown above with the dash insert flipped down and the extension plugged onto the circuit board pins along with mating end of the extension plugged into the dash connection.

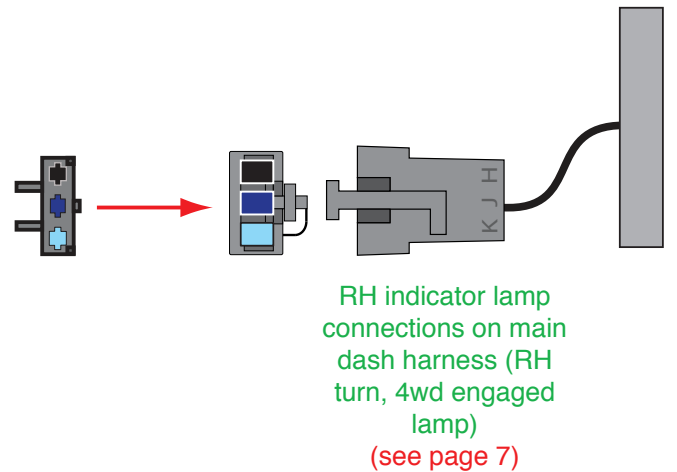
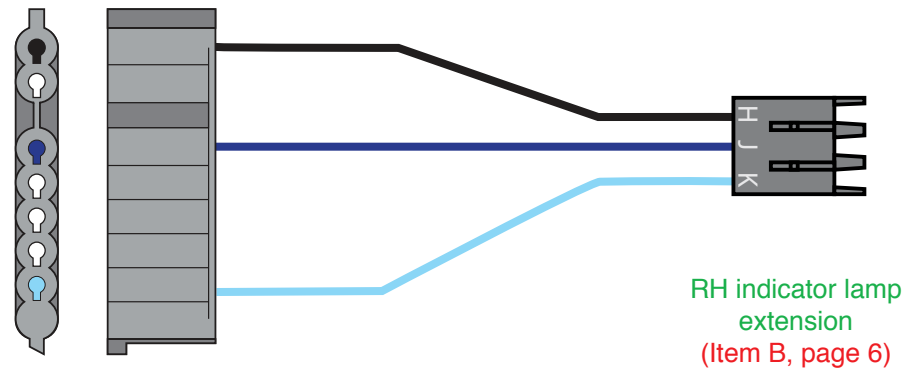

NOTE: shown here is the optional rear defroster switch connection.  
(available separately, 510797, see page 1)



www.americanautowire.com 856-933-0801

**1987-90 Jeep YJ**  
**510742**  
*Classic Update Series*  
92972617 Rev 0.0 8/19/2020

# 510743 Dash/Main harness installation instructions:

## 1987-1989 Fog light and/or rear defroster illumination lights instructions:

**NOTE:** This option is not present on all vehicles, and there may be up to two extensions required. These lights are used to back light the lower dash assembly area when the vehicle has optional fog lights and/or rear defroster. Your dash harness has 2 connections on it for these lights. We have also included 2 light extensions "T" for you to plug into the 2 main dash connections. If your vehicle does not have either of these options, the two main connections will lay up under the dash without being used. If you have one of the options, one light will be used, and if you have both options, both lights will be used. We have shown connection images at the right and a photo below for your convenience.

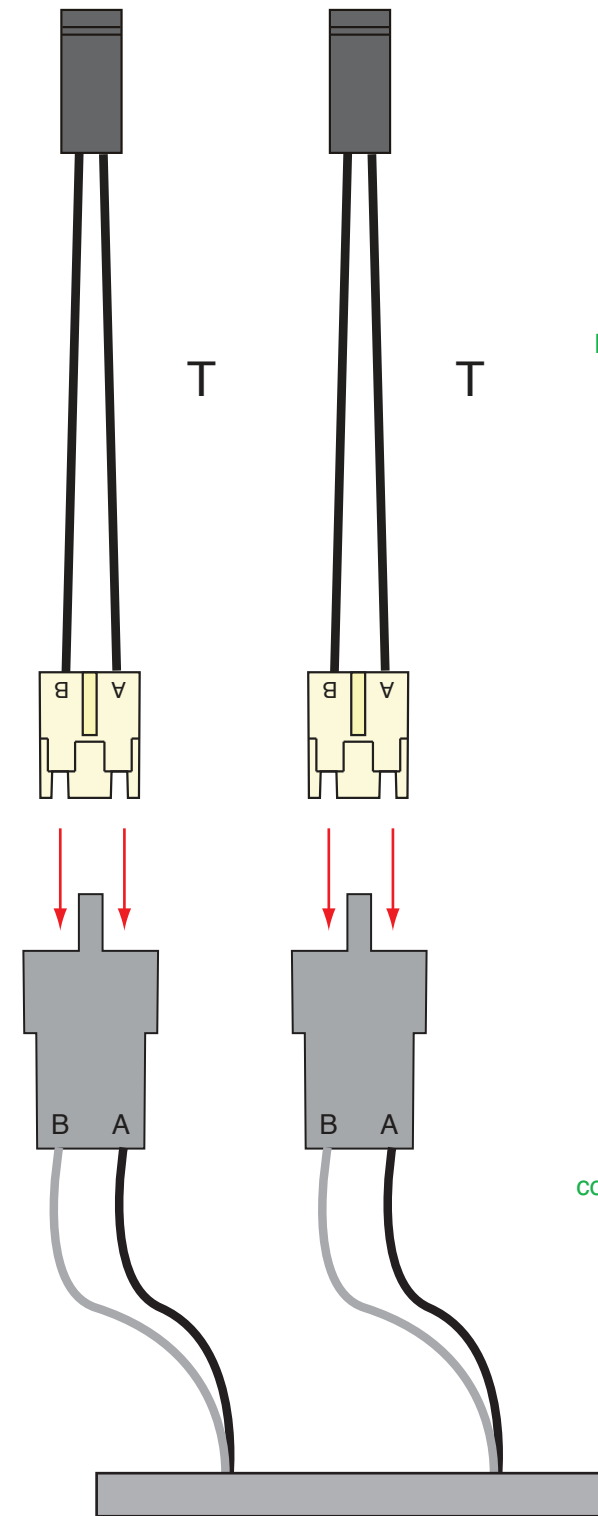

Fog light and rear defroster light extensions (2)  
(Items T, page 6)

Fog light and rear defroster illumination light connections on main dash harness (2)  
(see page 7)



**American  
Autowire**

www.americanautowire.com 856-933-0801

**1987-90 Jeep YJ  
510742**

*Classic Update Series*

92972617 Rev 0.0 8/19/2020



# 510743 Dash/Main harness installation instructions:

## 1990 Fog light, rear defroster, and/or rear wiper illumination lamps instructions:

**NOTE:** Your vehicle could have any of these options, or none. There was only one lamp extension used on the 1990 vehicles. These lights are used to front light the lower dash assembly area when the vehicle has optional fog lights, rear defroster and/or rear wiper options. Your dash harness has 2 connections on it for these lights, but you will only use one of the two. You will have to harvest the stock lamp socket assembly with the orange and black wires from your original dash harness to build an extension. We have included terminals G and connector E for you to build a completed extension. We have shown a connection image at the right and a photo below for your convenience.

**Note:** You will need to harvest the original lamp socket pigtail from your rear wiper/rear defroster illumination lamp. Leave about 6 inches of wire on each lead, crimp terminal G on each, and plug the leads into connector E so that the orange wire is in cavity B and the black wire is in cavity A. Plug completed extension into the dash connection. (see terminals G and connector E on page 6)



2nd fog light, rear defroster, and rear wiper illumination light connections on main dash harness. **NOT** used. (see page 7)

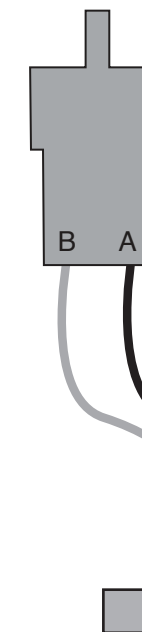

Fog light, rear defroster, and rear wiper illumination light connections on main dash harness. Only 1 is used. (see page 7)

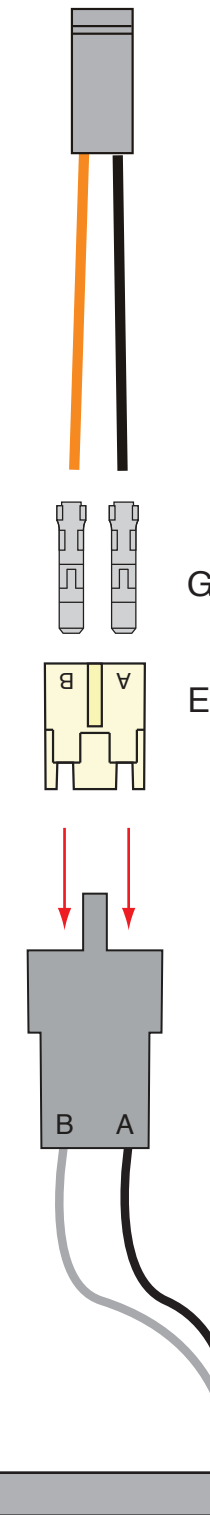

www.americanautowire.com 856-933-0801

**1987-90 Jeep YJ**  
**510742**

*Classic Update Series*

92972617 Rev 0.0 8/19/2020



# 510743 Dash/Main harness installation instructions:

## cigar lighter feed and ground connection instructions:

**NOTE:** Below is a photo of the completed cigar lighter assembly as it will appear connected in your vehicle. The orange wire with the rubber sleeve is the feed wire and will slide onto the threaded stud on your cigar lighter assembly. The double black wires with the female connector are the ground lead and will connect to the male blade on your cigar lighter assembly to complete the circuit. To the right in the photo, there is an illumination lamp that will have to be harvested from your original harness to be re-used. Plug wire D from page 6 into the candelabra as shown on page 8, route that wire over to your lighter assembly and cut it to length. Apply terminal M and sleeve N to the end of wire D. Next, apply terminal U and sleeve L to the end of the reclaimed lamp assembly, then plug terminal U into terminal M to complete the cigar lighter lamp.

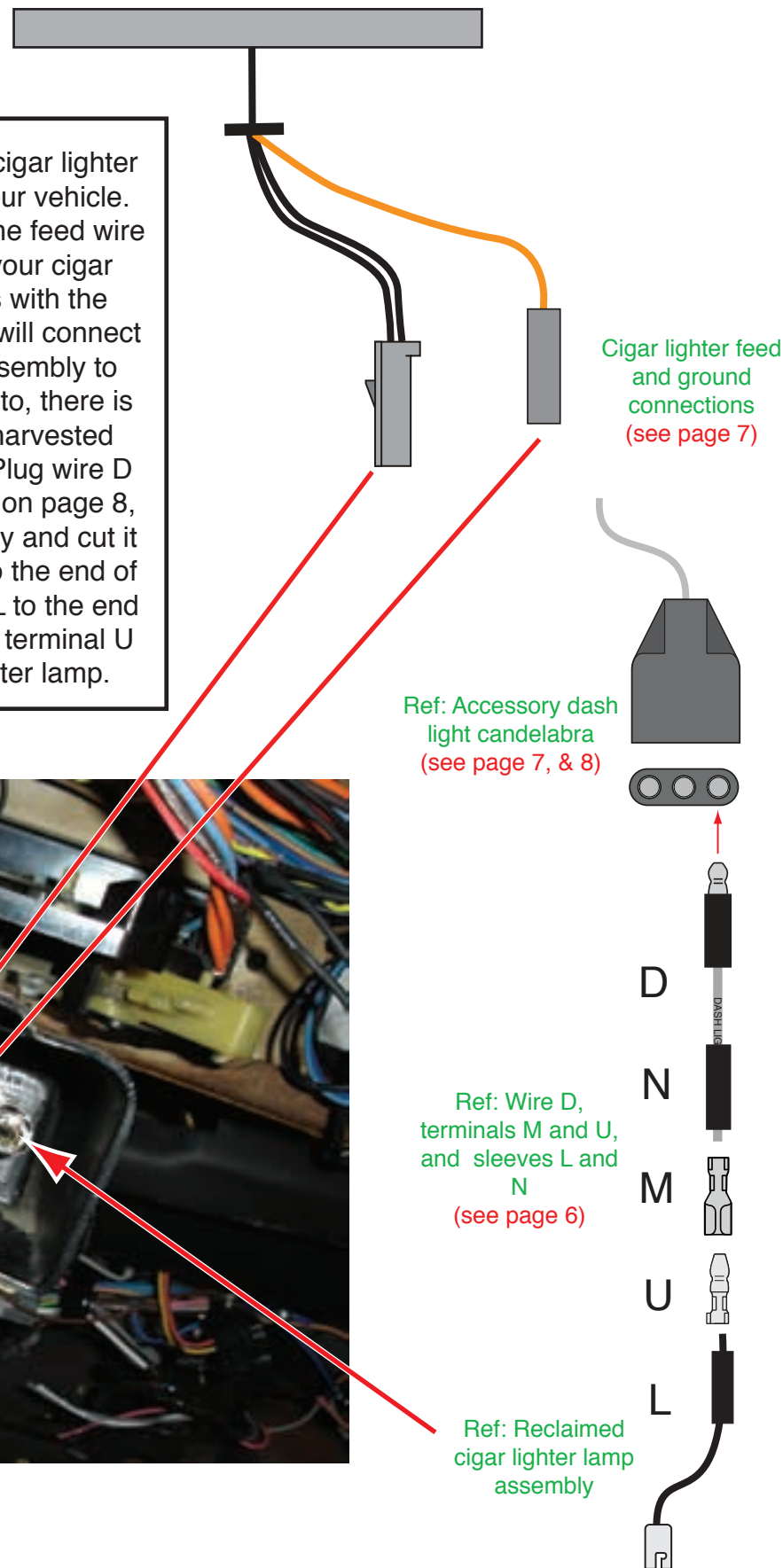
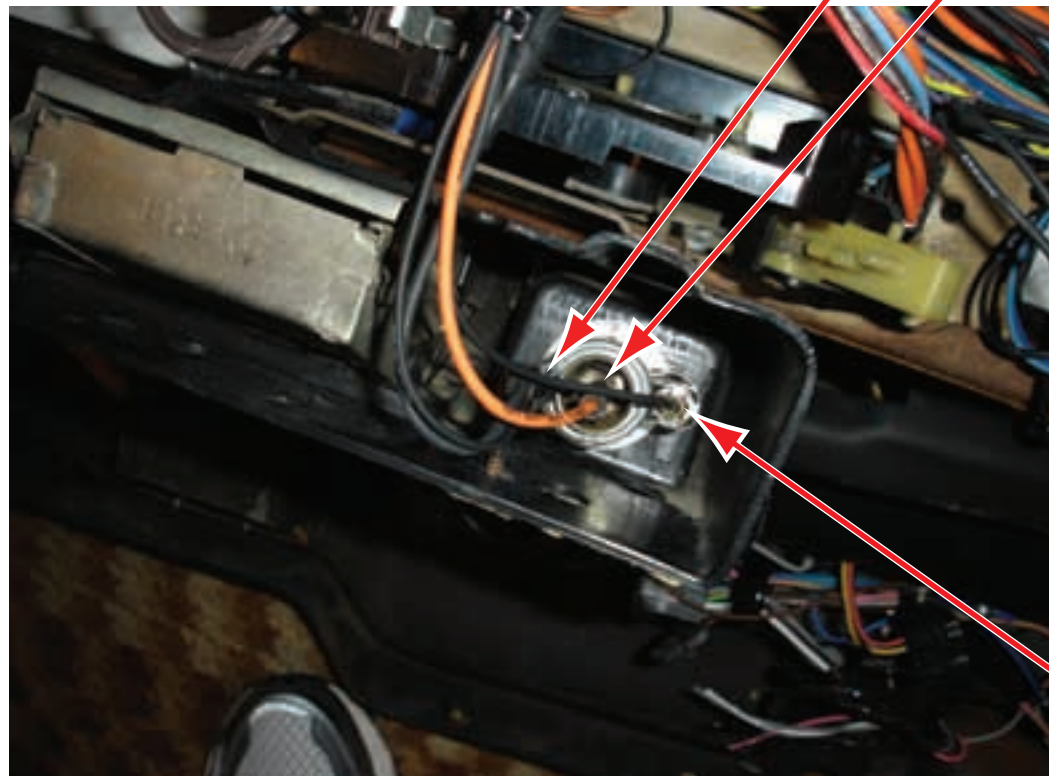

## Original A/C harness connection instructions:

**NOTE:** This kit **DOES NOT** include any factory A/C harness wiring, but **WILL** support the factory A/C wiring in your vehicle should your Jeep have that option. There were several different configurations and wire colors used from 1987 through 1990. This new kit will support connections to your original power wire, compressor (or low pressure switch wire), and the system ground wire. You will need to identify the 12v feed, compressor and system ground wires for your year vehicle based on the factory schematics and tie them into the new dash harness. After identifying your 12v feed, compressor and system ground wires, crimp terminals J on each of the three wires and plug them into connector S so that your on/off power wire mates with the AAW brown wire, your compressor wire mates with the AAW dark green wire, and your system ground wire mates with the AAW black wire once you plug connector S into the new dash harness.

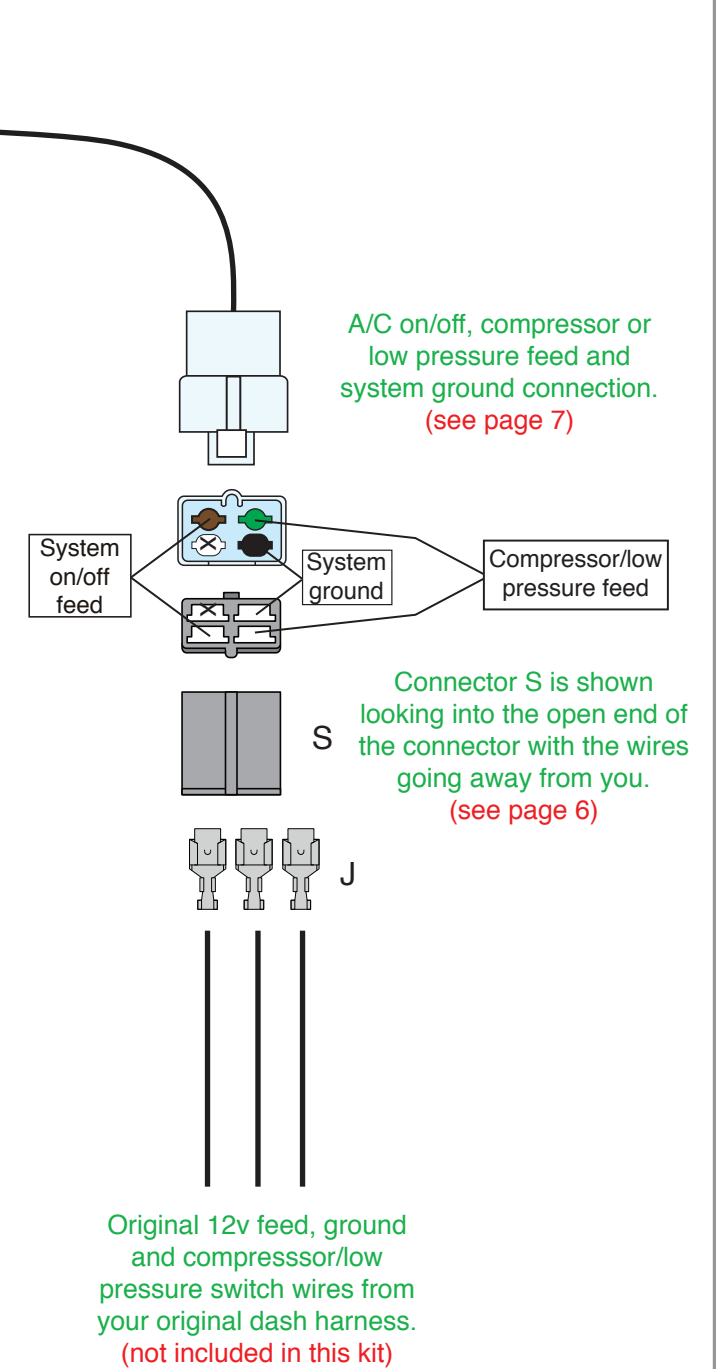

www.americanautowire.com 856-933-0801

**1987-90 Jeep YJ**  
**510742**

*Classic Update Series*

92972617 Rev 0.0 8/19/2020

# 510743 Dash/Main harness installation instructions:

## Heater switch on/off connection instructions:

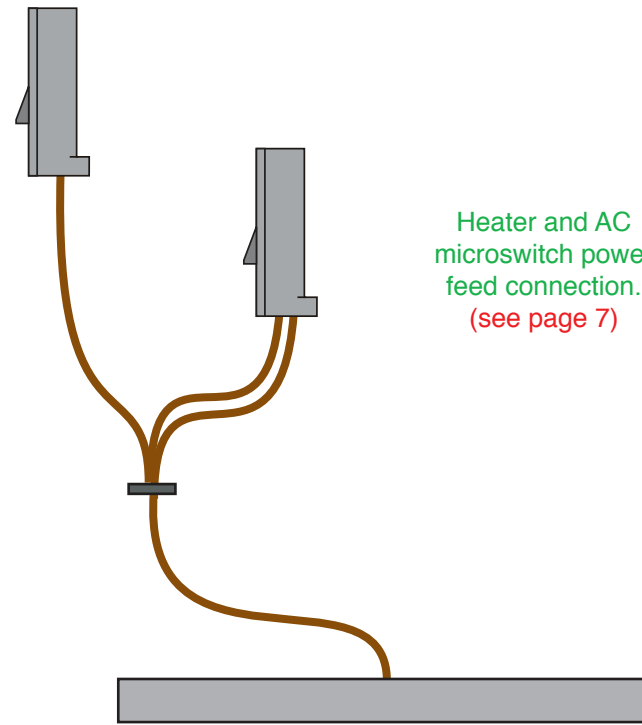

Heater and AC microswitch power feed connection. (see page 7)

**Note:** These two brown wire connections will need to be plugged onto the heater control microswitch as shown below. The single wire is longer and is intended to be installed on the blade that is closest to the face of the control head for ease of installation only. This is just an "open and close" switch that passes power to "heater blower switch connector" shown on page 7, or the "A/C on/off, compressor / low pressure feed and system ground connection" shown on pages 7 (with details on page 12).



## Heater panel illumination lamp instructions:

**Note:** You will need to harvest the original lamp socket pigtail from your heater panel illumination lamp. Leave about 6 inches of wire on each lead, crimp terminal G on each, and plug the leads into connector E so that the orange wire is in cavity B and the black wire is in cavity A. Plug completed extension into the dash connection. (see terminals G and connector E on page 6)

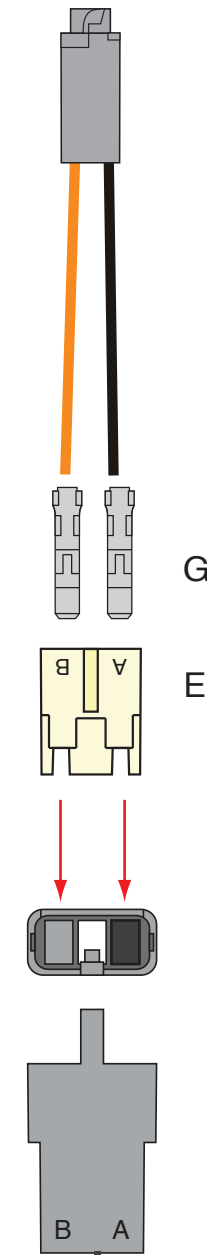

Heater panel illumination light connection on main dash harness (see page 7)



**American  
Autowire**

www.americanautowire.com 856-933-0801

**1987-90 Jeep YJ  
510742**

*Classic Update Series*

92972617 Rev 0.0 8/19/2020

# 510743 Dash/Main harness installation instructions:

VSS dash jumper connection to the 500730 VSS lead wire kit:

## Electric Speedo VSS connection:

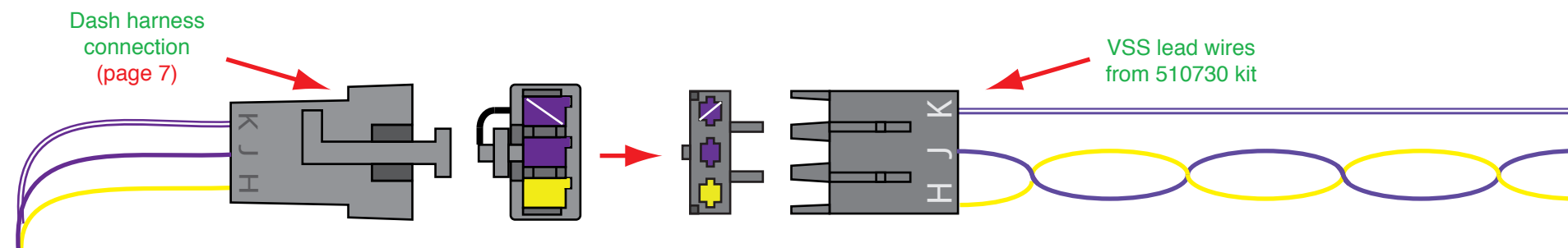

If you are using an aftermarket electric speedometer in your vehicle, you will need to connect the vehicle speed sensor (VSS) Lead Wires from this kit to the dash side connection of your dash harness. The yellow and solid purple wires must remain twisted together as shown above. These three wires will need to pass through the firewall or floor of your vehicle down to the vehicle speed sensor unit in the transmission. Generally, the solid purple wire connects to the “signal” lead, the yellow wire connects to the “ground” lead, and the purple/white stripe wire connects to the “12 volt power” lead on the vehicle speed sensor assembly. However, you should consult the directions that came with your gauges, and connect your vehicle speed sensor per the manufacturer’s instructions.

## Radio wire connections:

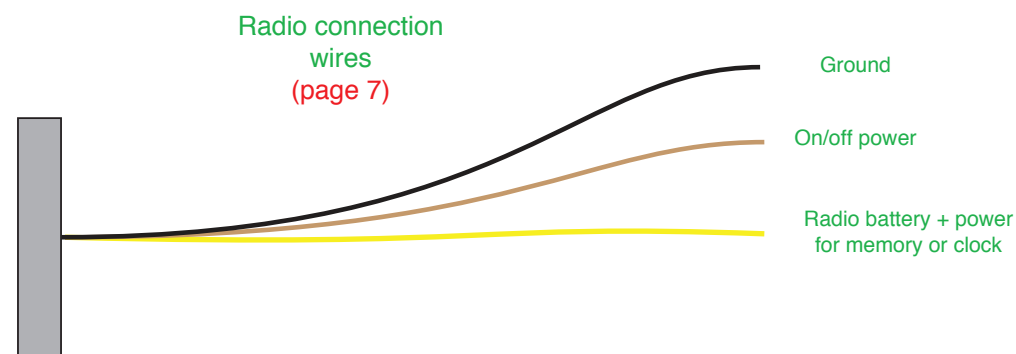



**NOTE:** These (3) wires will be used to hook-up your radio. The black is the radio ground, the tan is the “keyed” on/off power feed, and the yellow is the battery+ feed that is hot at all times and would be used for the digital read-out or memory feature on an electronically controlled radio.

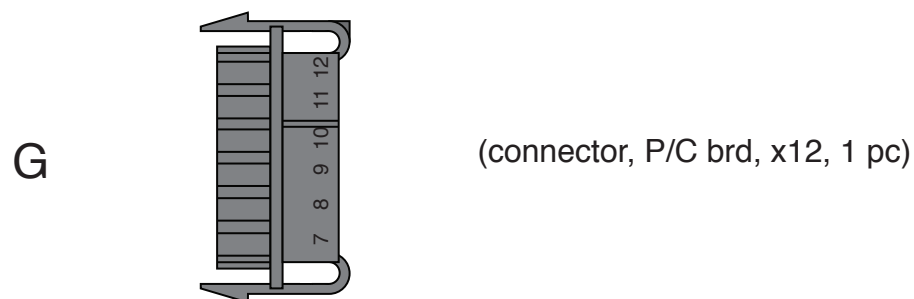
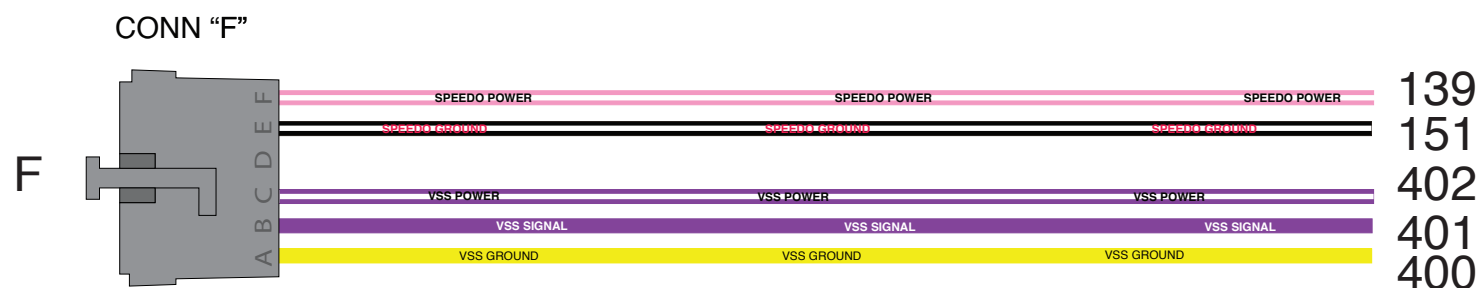
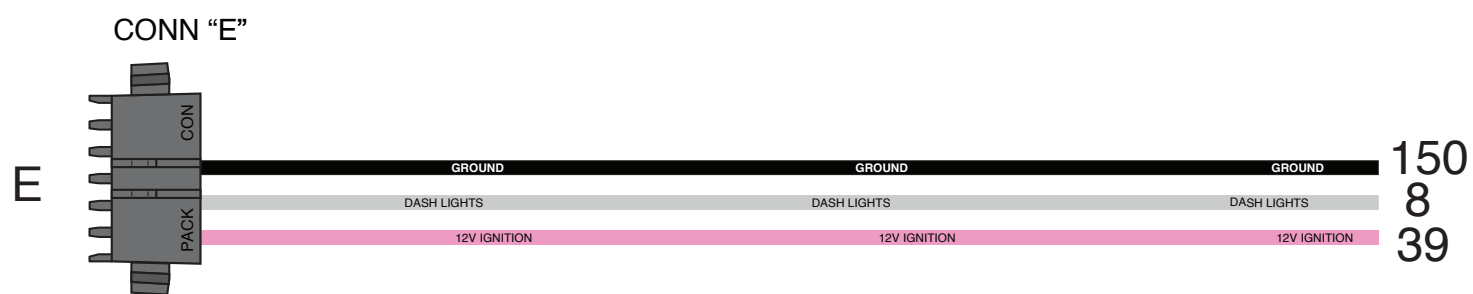
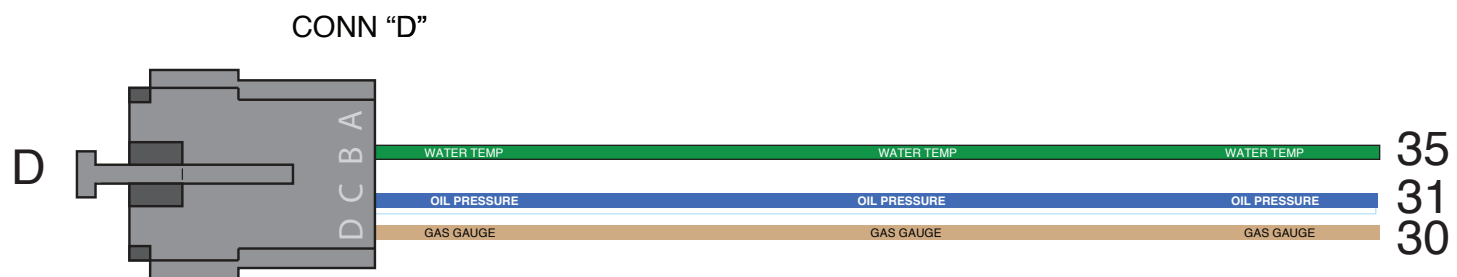

# 510744 Gauge Cluster harness installation instructions:

Below are the supplied harnesses, terminals and connector bodies included in the Gauge Cluster Harness 510744 and Loose Piece bag. These will be used to complete your gauge cluster connections and are referenced by the letters and descriptions below from this point forward.



J  (terminal, male p/c, 16-18, 10 pcs)

K  (terminal, double male p/c, 18-18,18-16, 5 pcs)

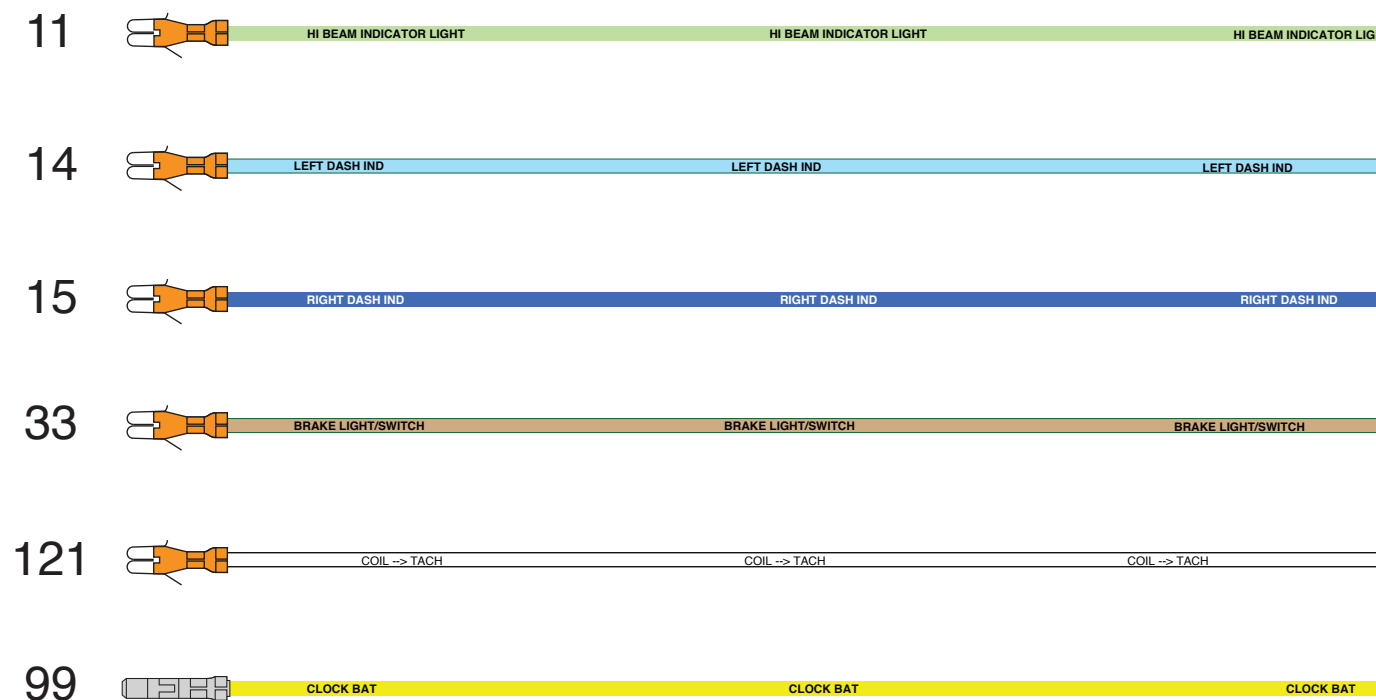

www.americanautowire.com 856-933-0801

**1987-90 Jeep YJ**  
**510742**  
*Classic Update Series*

92972617 Rev 0.0 8/19/2020

# 510744 Gauge Cluster harness installation instructions:

## GAUGE CLUSTER HARNESS INSTALLATION INSTRUCTIONS - ALL YEARS

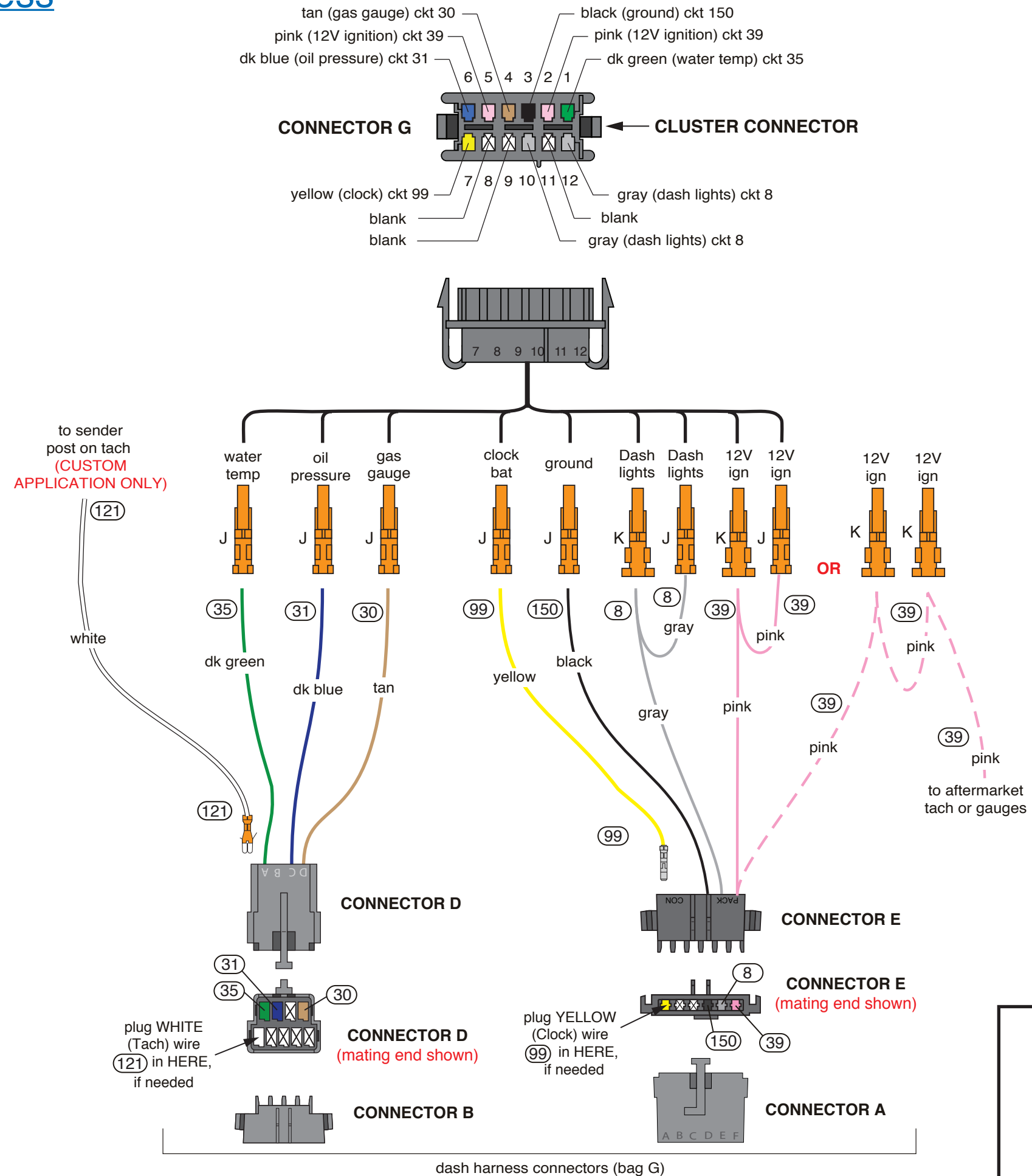

www.americanautowire.com 856-933-0801

**1987-90 Jeep YJ**  
**510742**

*Classic Update Series*

92972617 Rev 0.0 8/19/2020

# 510744 Gauge Cluster harness installation instructions:

SHOWN BELOW IS A TYPICAL **AFTERMARKET GAUGE** INSTALLATION PROCEDURE. FOLLOW THE MANUFACTURER'S INSTRUCTIONS FOR BEST RESULTS.

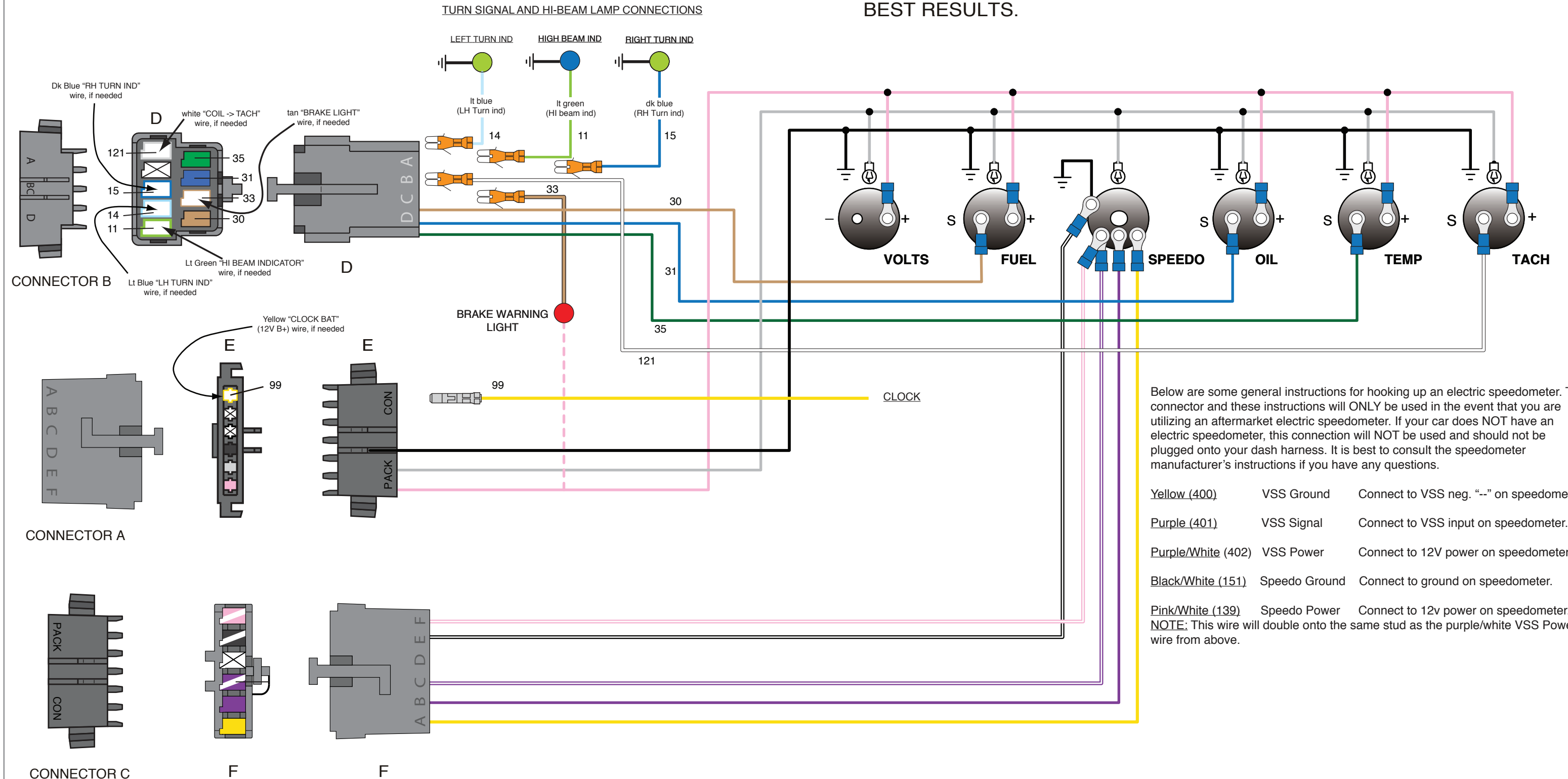

Below are some general instructions for hooking up an electric speedometer. This connector and these instructions will ONLY be used in the event that you are utilizing an aftermarket electric speedometer. If your car does NOT have an electric speedometer, this connection will NOT be used and should not be plugged onto your dash harness. It is best to consult the speedometer manufacturer's instructions if you have any questions.

- Yellow (400)** VSS Ground Connect to VSS neg. "--" on speedometer.
- Purple (401)** VSS Signal Connect to VSS input on speedometer.
- Purple/White (402)** VSS Power Connect to 12V power on speedometer.
- Black/White (151)** Speedo Ground Connect to ground on speedometer.
- Pink/White (139)** Speedo Power Connect to 12v power on speedometer.  
**NOTE:** This wire will double onto the same stud as the purple/white VSS Power wire from above.



www.americanautowire.com 856-933-0801

**1987-90 Jeep YJ**  
**510742**

*Classic Update Series*

92972617 Rev 0.0 8/19/2020



# 510745 Engine harness installation instructions:

**Legend:** Shown below, are the supplied parts and wires included in the 510745 Engine Harness and Loose Piece bag required to complete your engine harness connections.

A		(Ring terminal, M5, 10-12 Ga., 2 pcs)	L		(terminal male, Weather Pack, 5 pcs)	BB		(A/T Neutral Safety Switch Ground Jumper, ITEM "BB", 1 pc)
B		(terminal, 56 series double female, 5 pcs)	M		(terminal female, Weather Pack, 5 pcs)	CC		("SI" Alternator Jumper, ITEM "CC", 1 pc)
C		(terminal, 56 series single female, 13 pcs)	N		(Sleeve, rubber small, 5 pcs)	DD		STARTER SOLENOID-R (Starter Relay Resistor Bypass Wire, ITEM "DD", 1 pc)
D		(connector, 56 series single female, 8 pcs)	P		(connector, Weather Pack, 2-Way female, 1 pc)	EE		(M/T Starter Relay Ground Jumper, ITEM "EE", 1 pc)
E		(Sleeve, rubber large, 6 pcs)	Q		(connector, Weather Pack, 3-Way female, 1 pc)	FF		(Power Relay Output Wire Jumper ITEM "FF", 1 pc)
F		(connector, 56 Series, single male, 3 pcs)	R		(connector, Weather Pack, 3-Way male, 1 pc)	GG		12V BATTERY FUSED (Hood Light Feed Wire, ITEM "GG", 1 pc)
G		(connector w/notch, 56 series single female, 2 pcs)	S		(Bullet terminal, female, 5 pcs)	HH		ELECTRIC CHOKE (Electric Choke Feed Wire, ITEM "HH", 1 pc)
H		(Ring terminal, M5, 14-16 Ga., 5 pcs)	V		(connector, 56 series, 1-way female, 1 pc)	JJ		ALTERNATOR IGN ("SI" Alternator Ignition Feed Wire Jumper, ITEM "JJ", 1 pc)
J		(terminal, 56 Series single male, 5 pcs)	W		(connector, 56 series, 1-way female, 1 pc)	KK		(A/C Compressor & Low Pressure Switch Wire, ITEM "KK", 1 pc)
K		(seal, Weather Pack, 1 way, 8 pcs)	AA		(Starter Solenoid Feed Wire Jumper, ITEM "AA", 1 pc)			



**1987-90 Jeep YJ**  
**510742**

*Classic Update Series*

92972617 Rev 0.0 8/19/2020

# 510745 Engine harness installation instructions:



www.americanautowire.com 856-933-0801

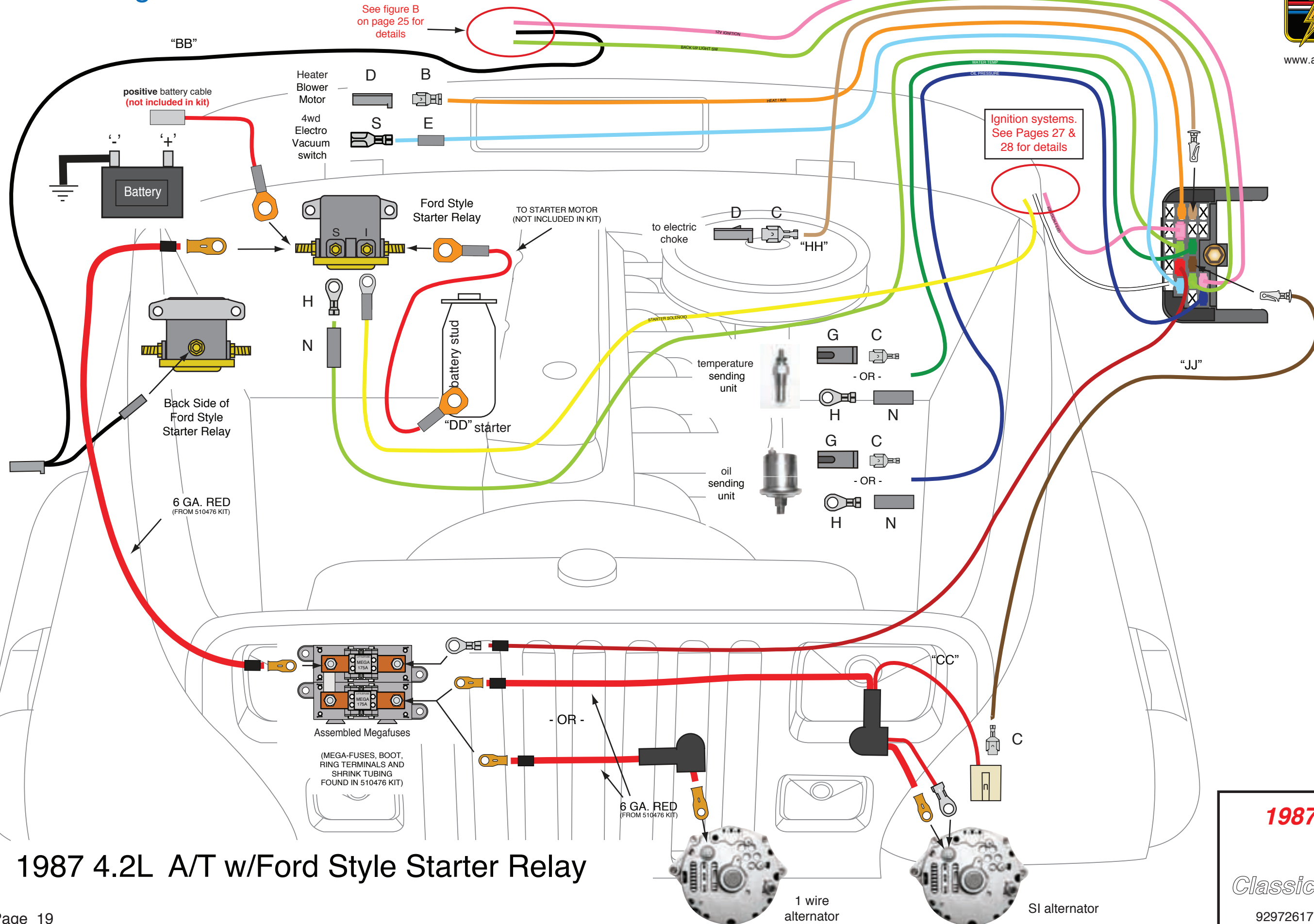

1987 4.2L A/T w/Ford Style Starter Relay

1987-90 Jeep YJ  
510742

Classic Update Series

92972617 Rev 0.0 8/19/2020

# 510745 Engine harness installation instructions:



www.americanautowire.com 856-933-0801

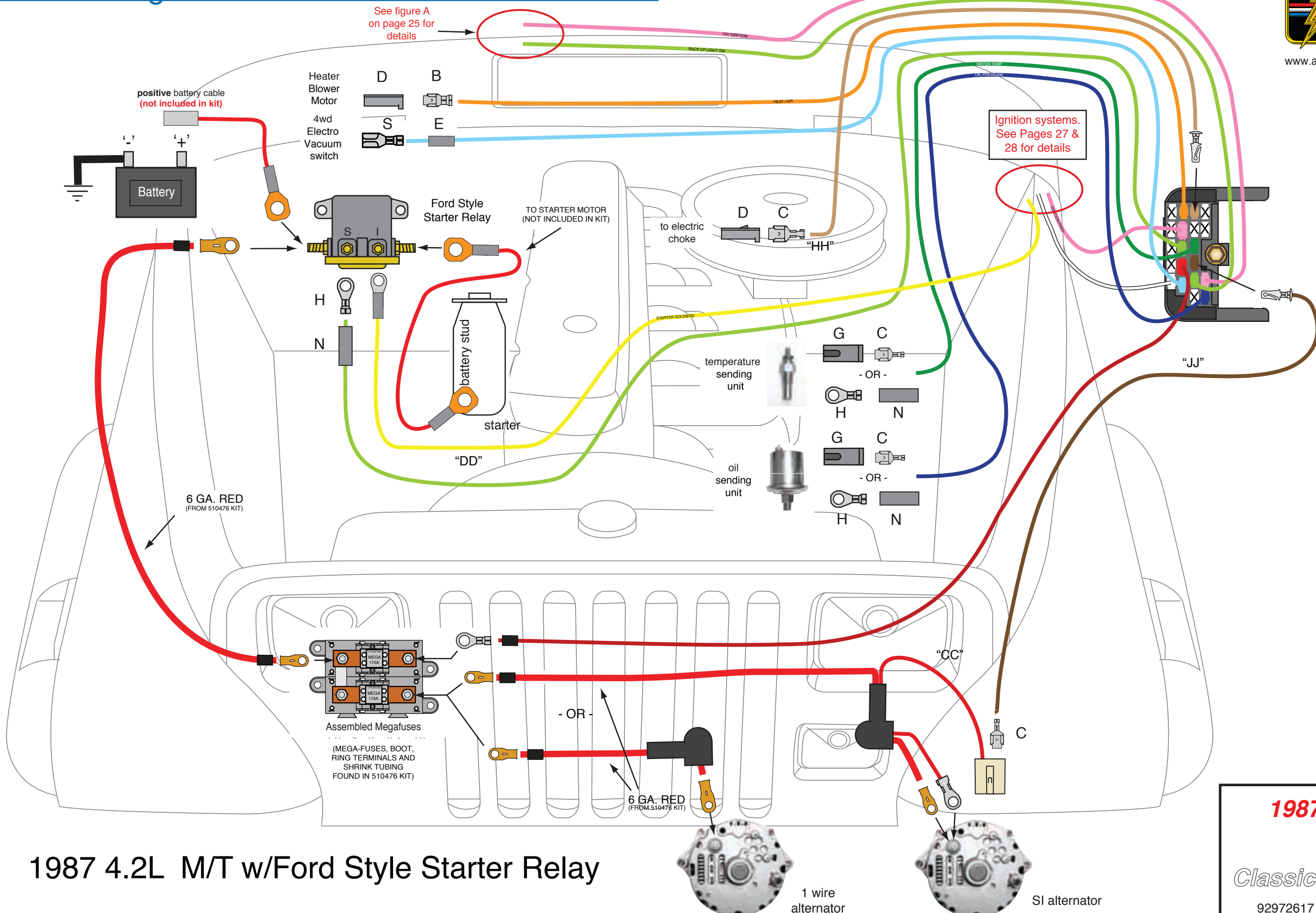

1987 4.2L M/T w/Ford Style Starter Relay

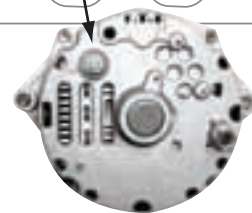

1 wire alternator

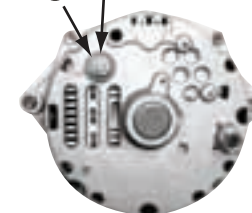

SI alternator

**1987-90 Jeep YJ**  
**510742**  
*Classic Update Series*  
 92972617 Rev 0.0 8/19/2020



# 510745 Engine harness installation instructions:



www.americanautowire.com 856-933-0801

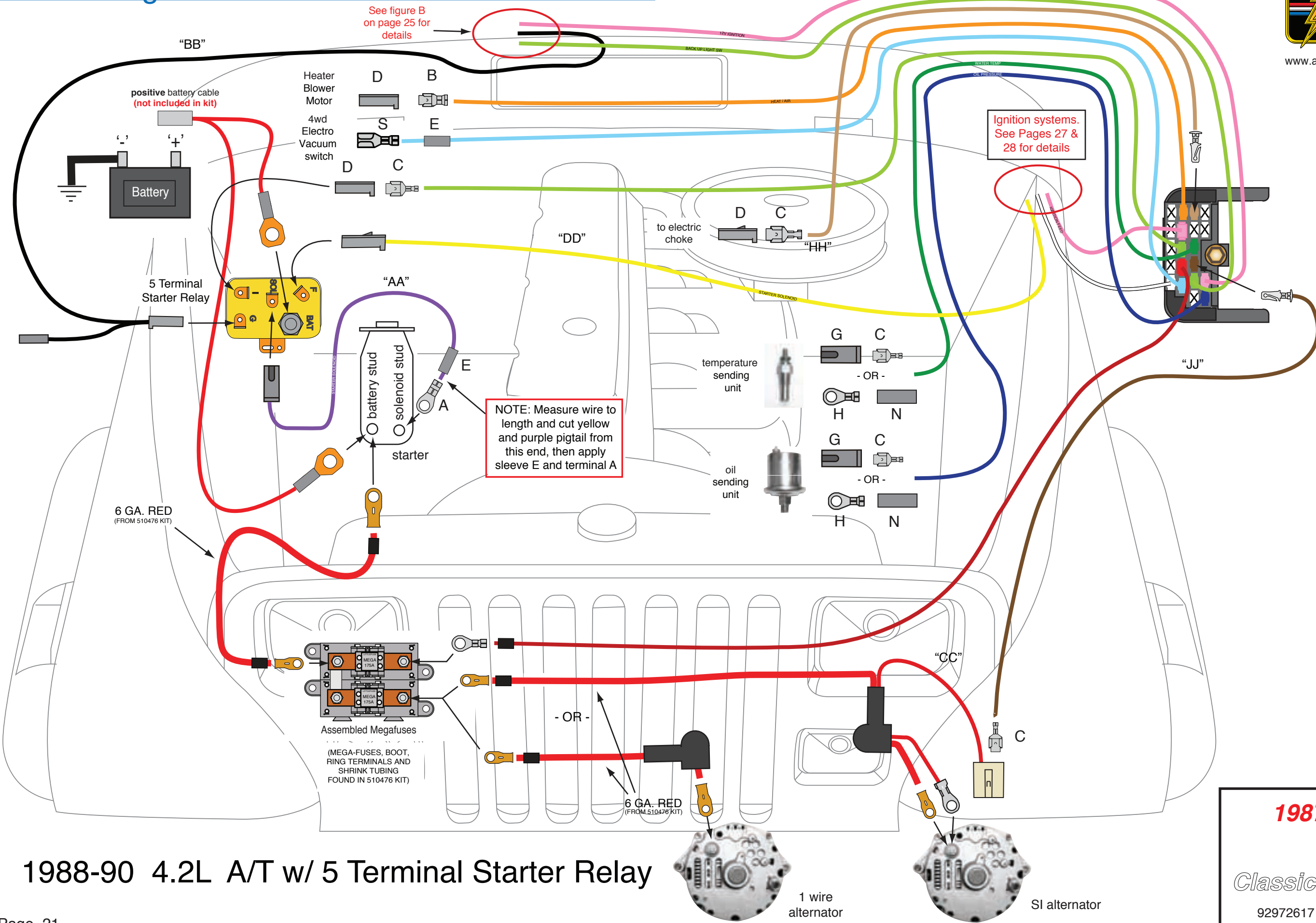

1988-90 4.2L A/T w/ 5 Terminal Starter Relay

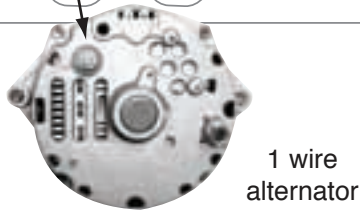

**1987-90 Jeep YJ**  
**510742**  
*Classic Update Series*  
 92972617 Rev 0.0 8/19/2020



# 510745 Engine harness installation instructions:



www.americanautowire.com 856-933-0801

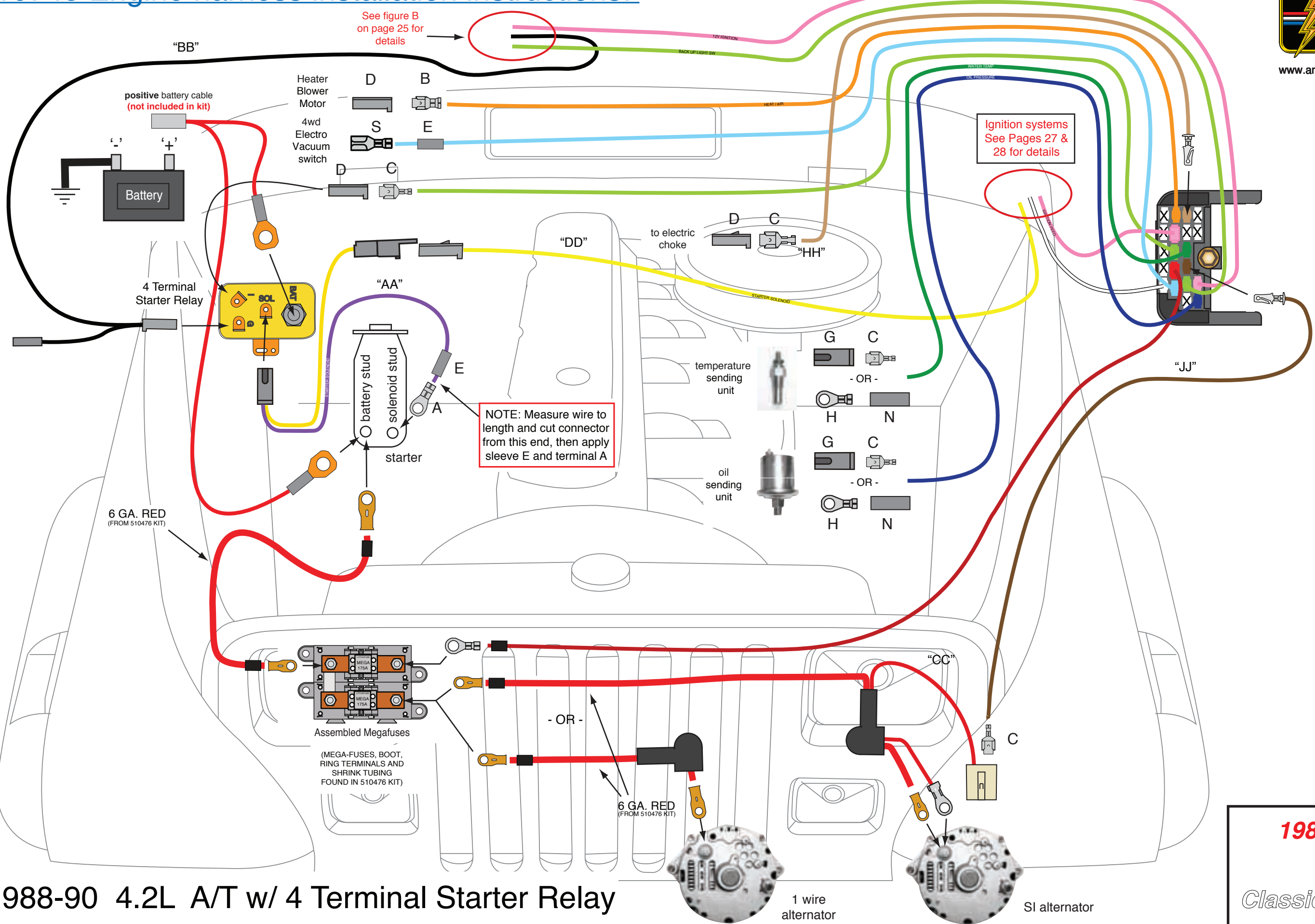

1988-90 4.2L A/T w/ 4 Terminal Starter Relay

**1987-90 Jeep YJ**  
**510742**  
*Classic Update Series*  
 92972617 Rev 0.0 8/19/2020



# 510745 Engine harness installation instructions:



www.americanautowire.com 856-933-0801

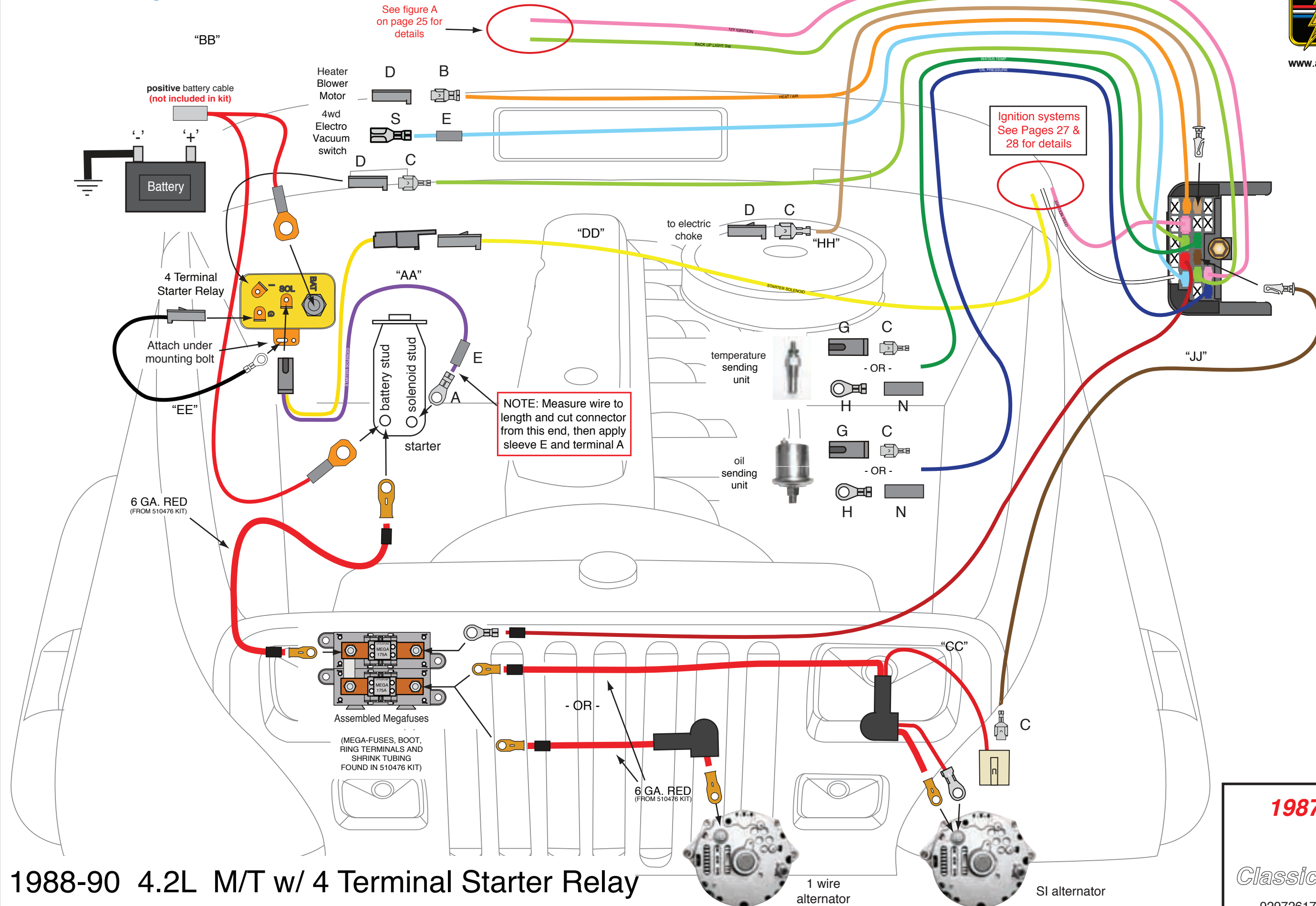

See figure A on page 25 for details

Ignition systems See Pages 27 & 28 for details

NOTE: Measure wire to length and cut connector from this end, then apply sleeve E and terminal A

Assembled Megafuses (MEGA-FUSES, BOOT, RING TERMINALS AND SHRINK TUBING FOUND IN 510476 KIT)

1988-90 4.2L M/T w/ 4 Terminal Starter Relay

**1987-90 Jeep YJ**  
**510742**  
*Classic Update Series*  
 92972617 Rev 0.0 8/19/2020

# 510745 Engine harness installation instructions:



www.americanautowire.com 856-933-0801

## Back up and Neutral Safety Switch Transmission Circuit Connections

**FIGURE "A"**

Back-up Light Switch  
Manual Transmission

See Pages 19-24 For  
Your Engine Application

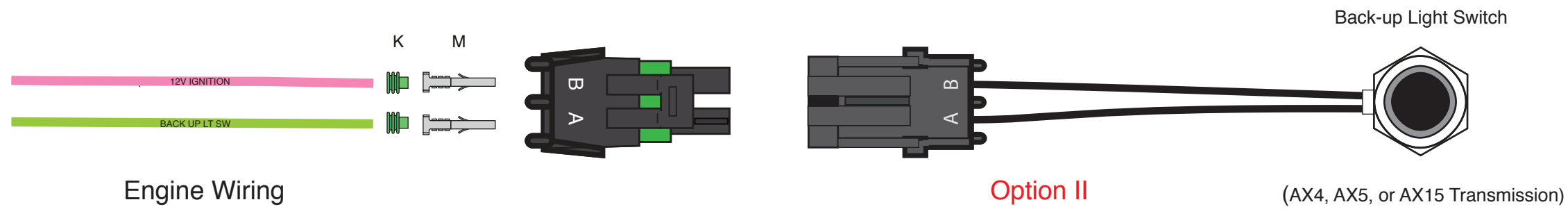
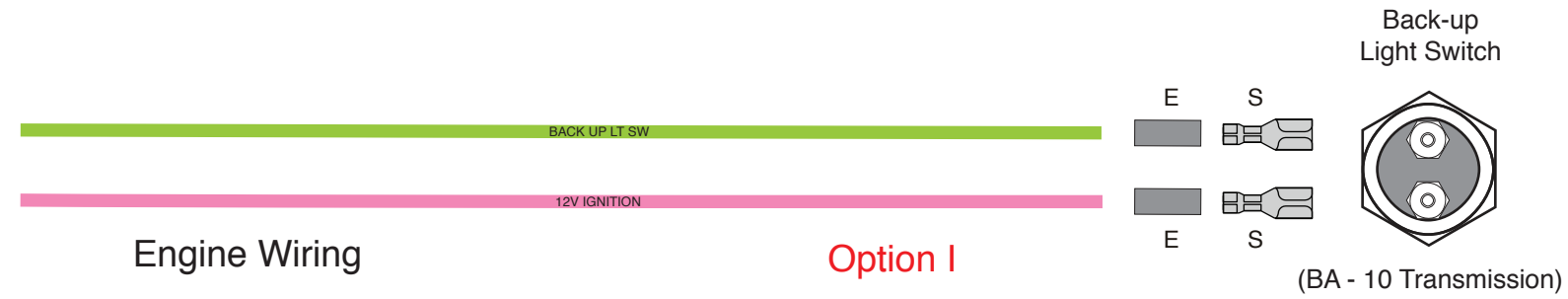

**FIGURE "B"**

Back-up Light Switch/Neutral Safety Switch  
Automatic Transmission

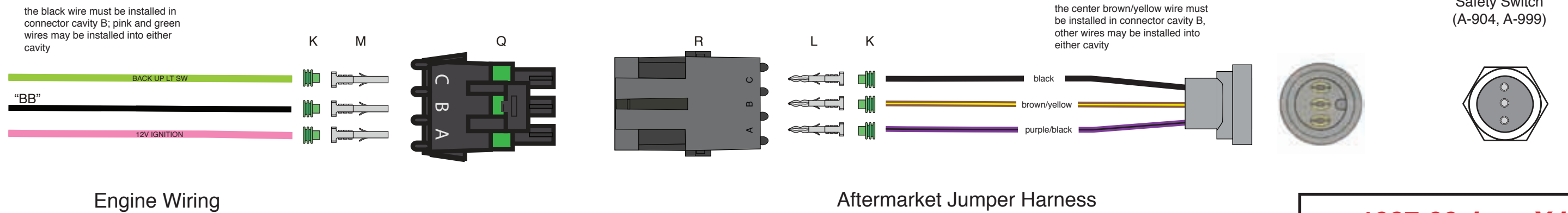

**1987-90 Jeep YJ**  
**510742**  
*Classic Update Series*  
92972617 Rev 0.0 8/19/2020

## 510745 Engine Harness Kit Optional Systems:

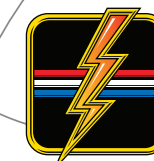
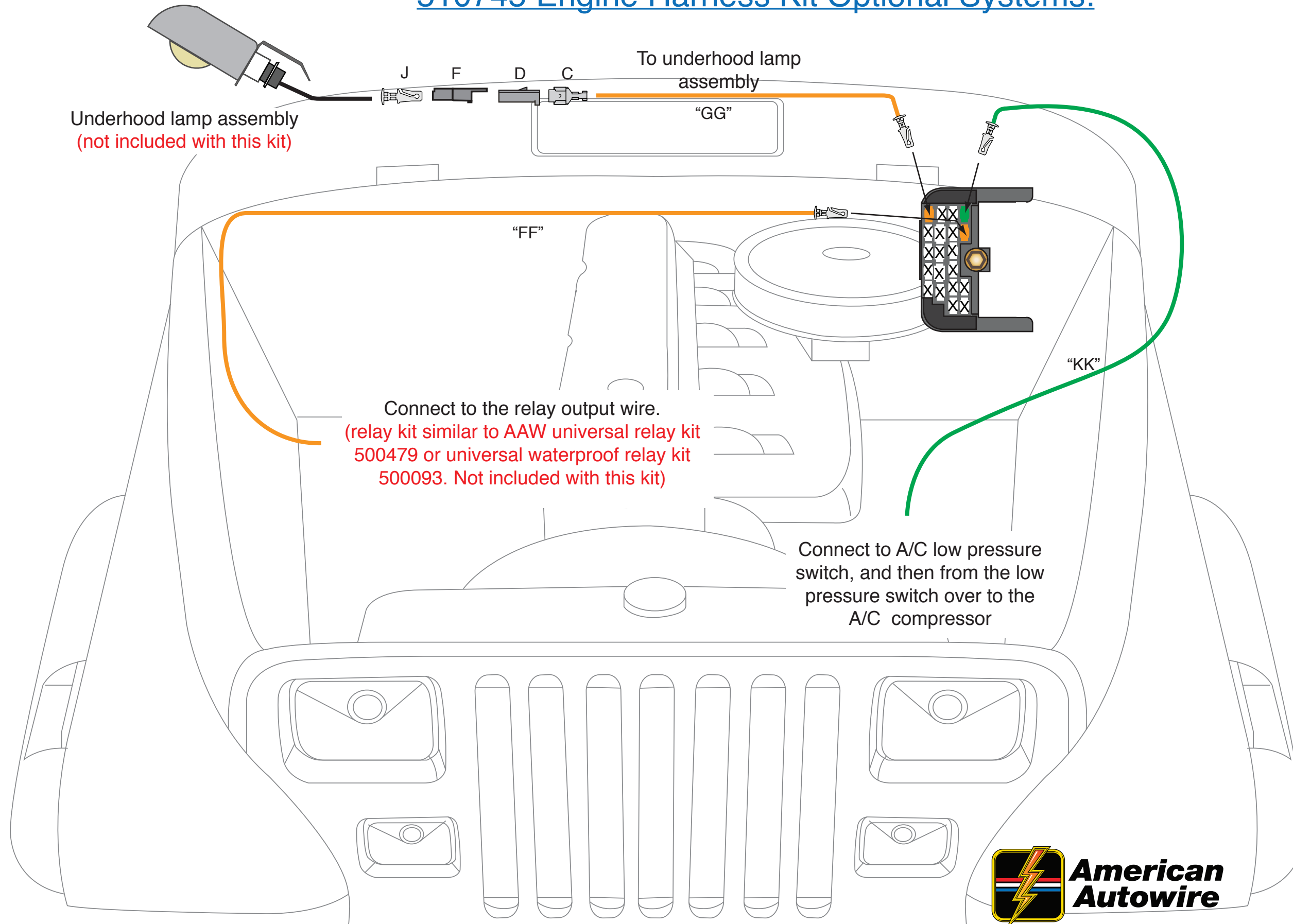

**American  
Autowire**

www.americanautowire.com 856-933-0801

**1987-90 Jeep YJ  
510742**

*Classic Update Series*

92972617 Rev 0.0 8/19/2020



# 510745 Engine harness installation instructions:

## Generic Dura-Spark Ignition system wiring:

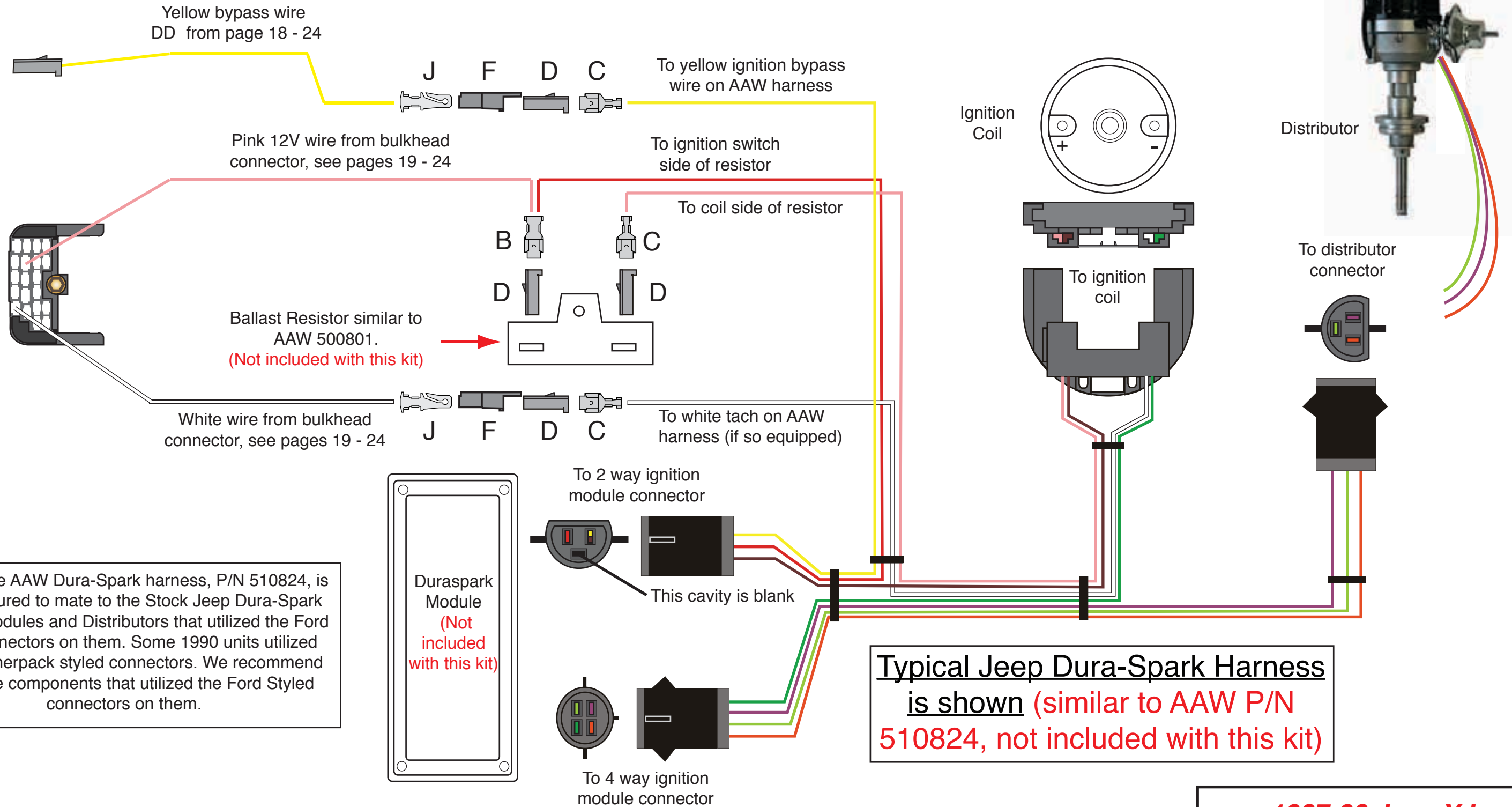

**NOTE:** The AAW Dura-Spark harness, P/N 510824, is manufactured to mate to the Stock Jeep Dura-Spark Ignition modules and Distributors that utilized the Ford style connectors on them. Some 1990 units utilized GM weatherpack styled connectors. We recommend using the components that utilized the Ford Styled connectors on them.

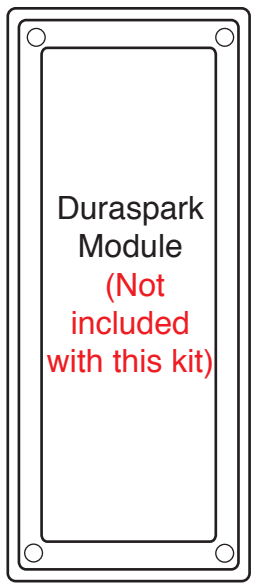

**Typical Jeep Dura-Spark Harness is shown (similar to AAW P/N 510824, not included with this kit)**



www.americanautowire.com 856-933-0801

**1987-90 Jeep YJ**  
**510742**  
*Classic Update Series*  
 92972617 Rev 0.0 8/19/2020

# 510745 Engine harness installation instructions:

## HEI Type Ignition system wiring:

to **TACH** location on HEI distributor (optional)

to **BAT** location on HEI distributor



V

W

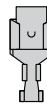
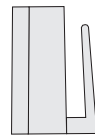

C

B

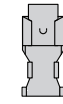

Pink 12V wire from bulkhead connector, see pages 19 - 24

White wire from bulkhead connector, see pages 19 - 24

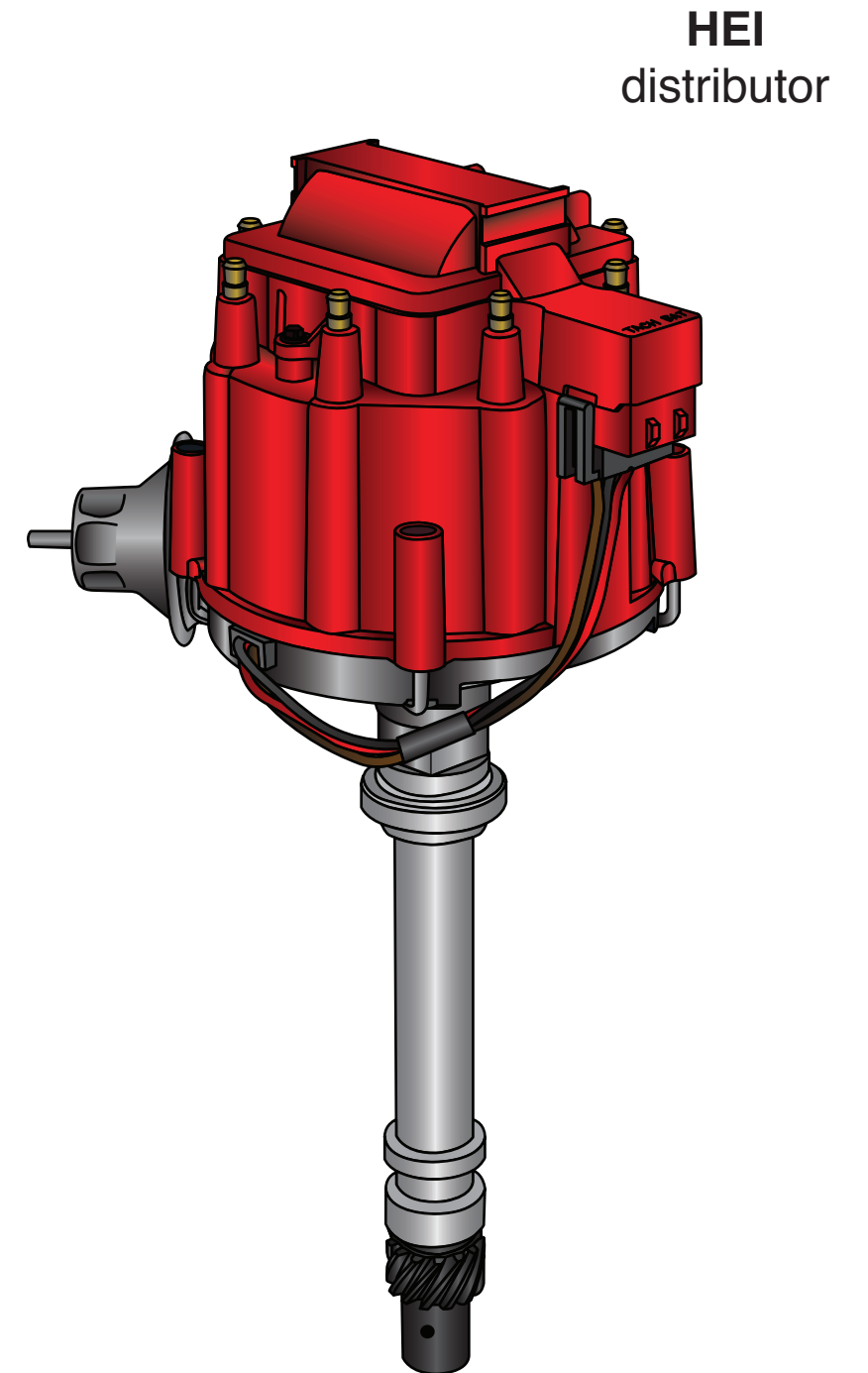

www.americanautowire.com 856-933-0801







1987-90 Jeep YJ  
510742



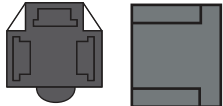
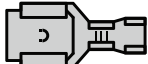

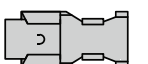
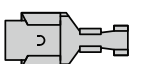

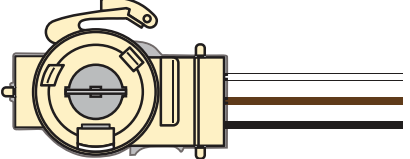

Classic Update Series

92972617 Rev 0.0 8/19/2020

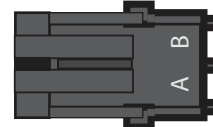
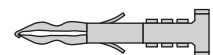
# 510746 Front Light installation instructions:

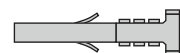
Below are the supplied terminals, connector bodies and assorted components included in the 510746 Front light Harness and Loose Piece bags. These will be used to complete your Front light Harness connections as shown on pages 30 through 32, and are referred by the letters and descriptions below.

- A  (Front Headlight Connector, 59 series 3-way, 2 pcs)
- B  (terminal, 59 series single female, 3 pcs)
- C  (terminal, 59 series double female, 6 pcs)
- D  (Park Light connector, 56 series 3-way female, 2 pcs)
- E  (terminal, 56 series double female, 10 pcs)
- F  (terminal, 56 series single female, 6 pcs)
- G  (RH Front Side Marker Extension, 1 pc)
- H  (connector w/notch, 56 series single female, 2 pcs)
- J  (park/turn light assembly, 2 pcs)
- K  (Ring Terminal, Ground Wire Extension, 2 pcs)

- L  (Brake Pressure Differential Warning Switch Extension L , 1 pc)
- M  (Brake Warning Switch connector, 56 series single female, 1 pc)
- N  (Fog Lamp Wiring connector, Weather Pack, male 2 pcs)
- P  (terminal male, Weather Pack, 6 pcs)
- Q  (seal, 1 way Weather Pack, 11 pcs)
- R  (Fog Lamp Pigtail, connector, Weather Pack, female, 2 pcs)
- S  (terminal female, Weather Pack, 6 pcs)
- T  (Fan Relay Trigger Wire T , 1 pc)
- U  (Fog Lamp Feed Wire Jumper U , 1 pc)
- V  (LH Front Side Marker Extension, 1 pc)



www.americanautowire.com 856-933-0801

**1987-90 Jeep YJ**  
**510742**  
*Classic Update Series*

92972617 Rev 0.0 8/19/2020



# 510746 Front Light installation instructions:



www.americanautowire.com 856-933-0801

CONNECTOR R, TERMINAL S, AND SEAL Q ARE AVAILABLE IN THE PARTS KIT 92972631. IF YOUR FOG LAMPS HAVE NO CONNECTORS OR HAVE NON-MATING CONNECTORS.

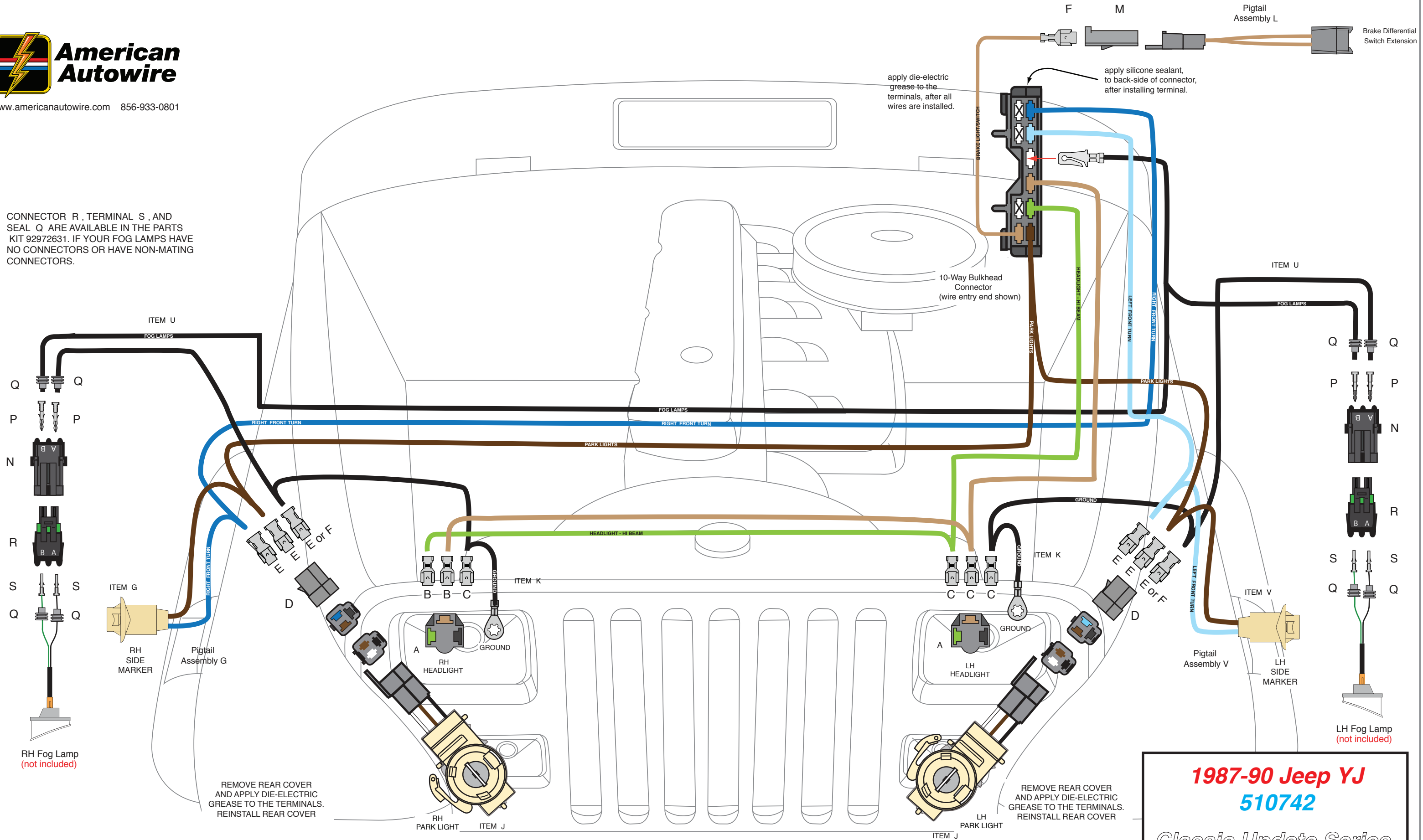

REMOVE REAR COVER AND APPLY DIE-ELECTRIC GREASE TO THE TERMINALS. REINSTALL REAR COVER

REMOVE REAR COVER AND APPLY DIE-ELECTRIC GREASE TO THE TERMINALS. REINSTALL REAR COVER

**1987-90 Jeep YJ**  
**510742**

*Classic Update Series*

92972617 Rev 0.0 8/19/2020

# 510746 Front Light installation instructions:

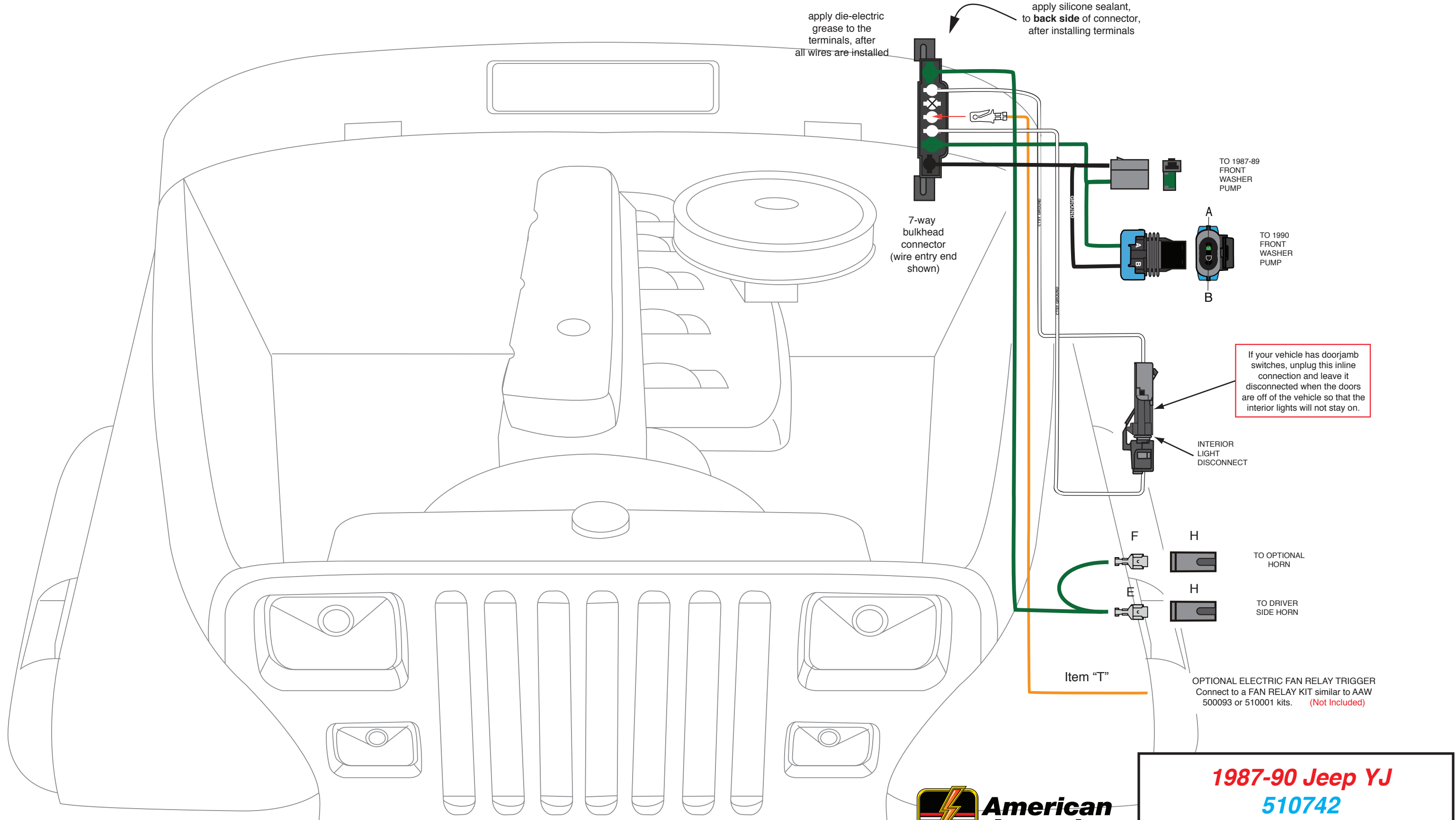

www.americanautowire.com 856-933-0801

**1987-90 Jeep YJ**  
**510742**  
*Classic Update Series*  
 92972617 Rev 0.0 8/19/2020

## 510742 finishing detail installation instructions:

Making your firewall electrical connection corrosion and weather resistant:

engine harness  
20-way connector

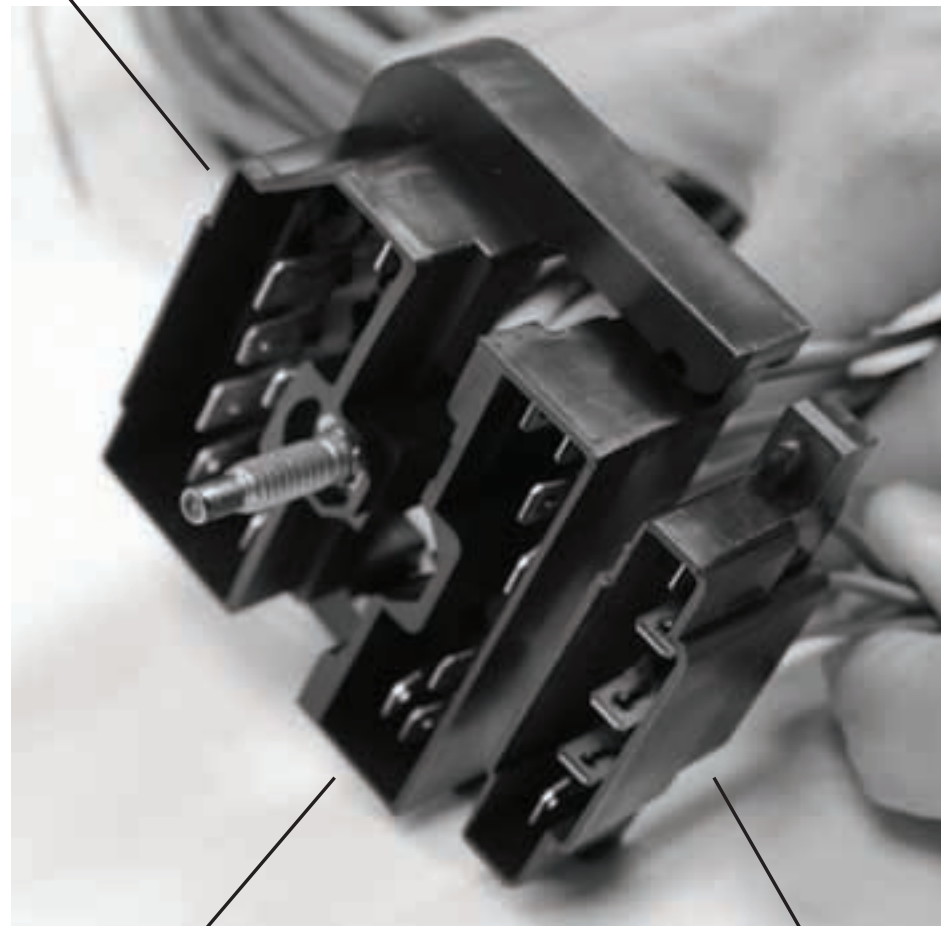

front light  
10-way connector

front light  
7-way connector

assembly, ready to bolt  
onto firewall bulkhead

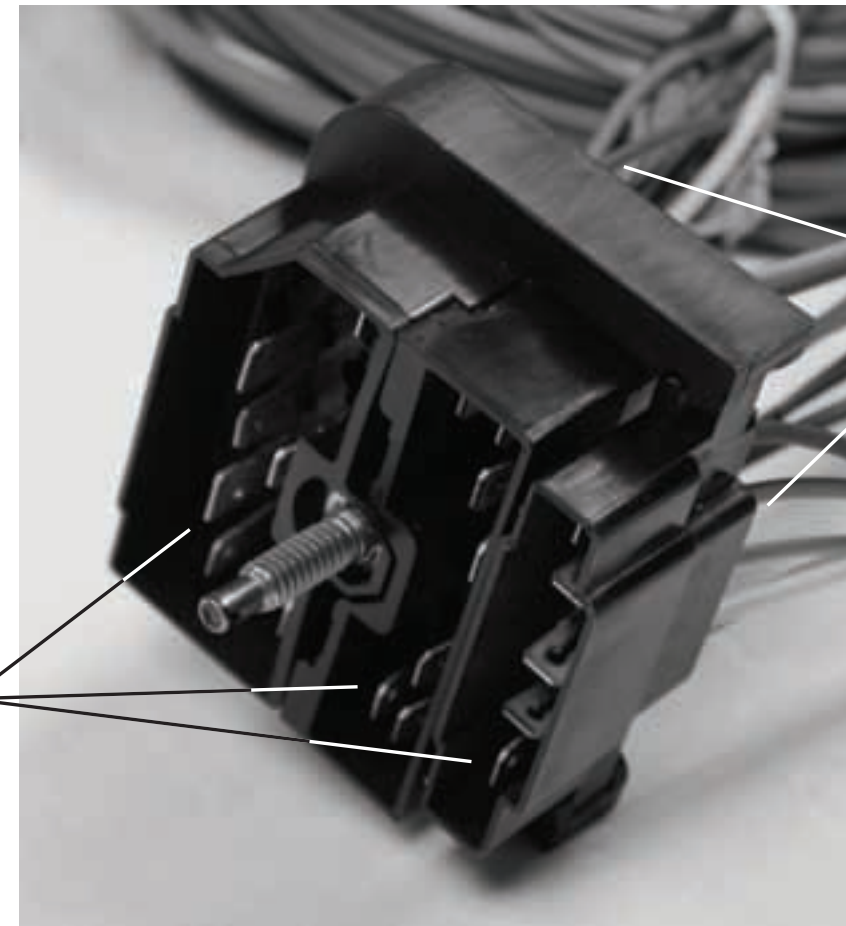

apply die-electric  
grease to the  
terminals, after  
all wires are installed

apply silicone sealant,  
to back side of connectors,  
after installing terminals

**NOTE 1:** If you have a 1990 model with a rear wiper and purchased the AAW 510807 add-on kit, DO NOT PROCEED with **NOTE 2** until after you have installed the purple/white stripe and black wires in the 10-way front light bulhead connector as shown on page 5 of the 510807 instruction set.

**NOTE 2:** We recommend the following once you have completed the installation of your underhood engine and forward lamp connections:

1. Remove the engine and front light connectors from the firewall and apply dielectric grease to the terminals as shown above. This will help with continuity and also prevent corrosion to any of the terminals.
2. Re-attach the engine and front light connectors to the firewall and apply silicone sealer to the front on the connector as shown above. This will help seal the connector and keep water and moisture from going through the connector to the inside of the vehicle via the bulkhead assembly.



www.americanautowire.com 856-933-0801

**1987-90 Jeep YJ**  
**510742**

*Classic Update Series*

92972617 Rev 0.0 8/19/2020



# 510747 Rear Body harness installation instructions:

Below are the supplied terminals, connector bodies and assorted components included in the 510747 Rear Body Harness and Loose Piece bags. These will be used to complete your Rear Body Harness exterior and interior connections as shown on pages 34 through 37, and are referenced by the letters and descriptions below.

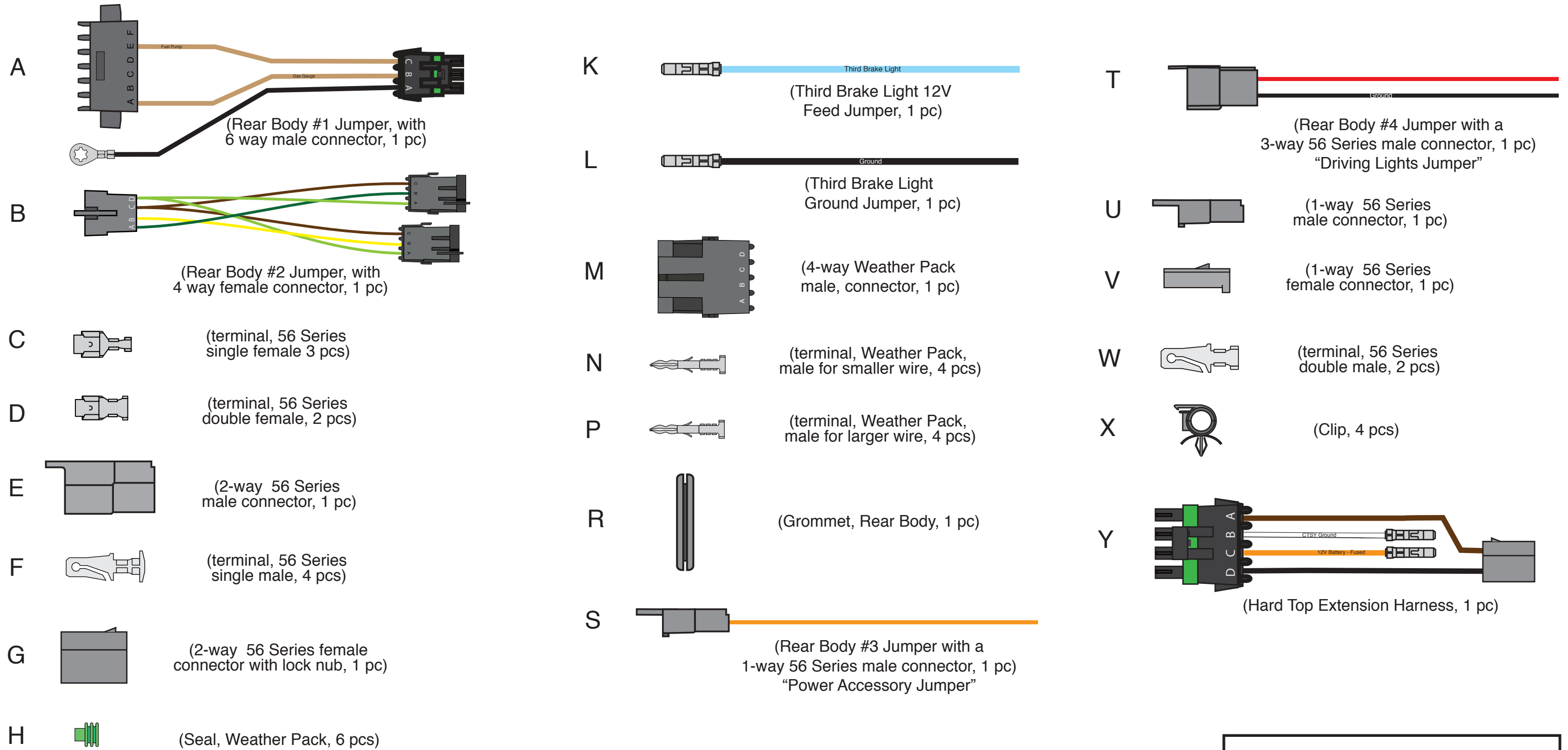

# 510747 Rear Body harness installation instructions:

## Main rear body harness installation instructions:

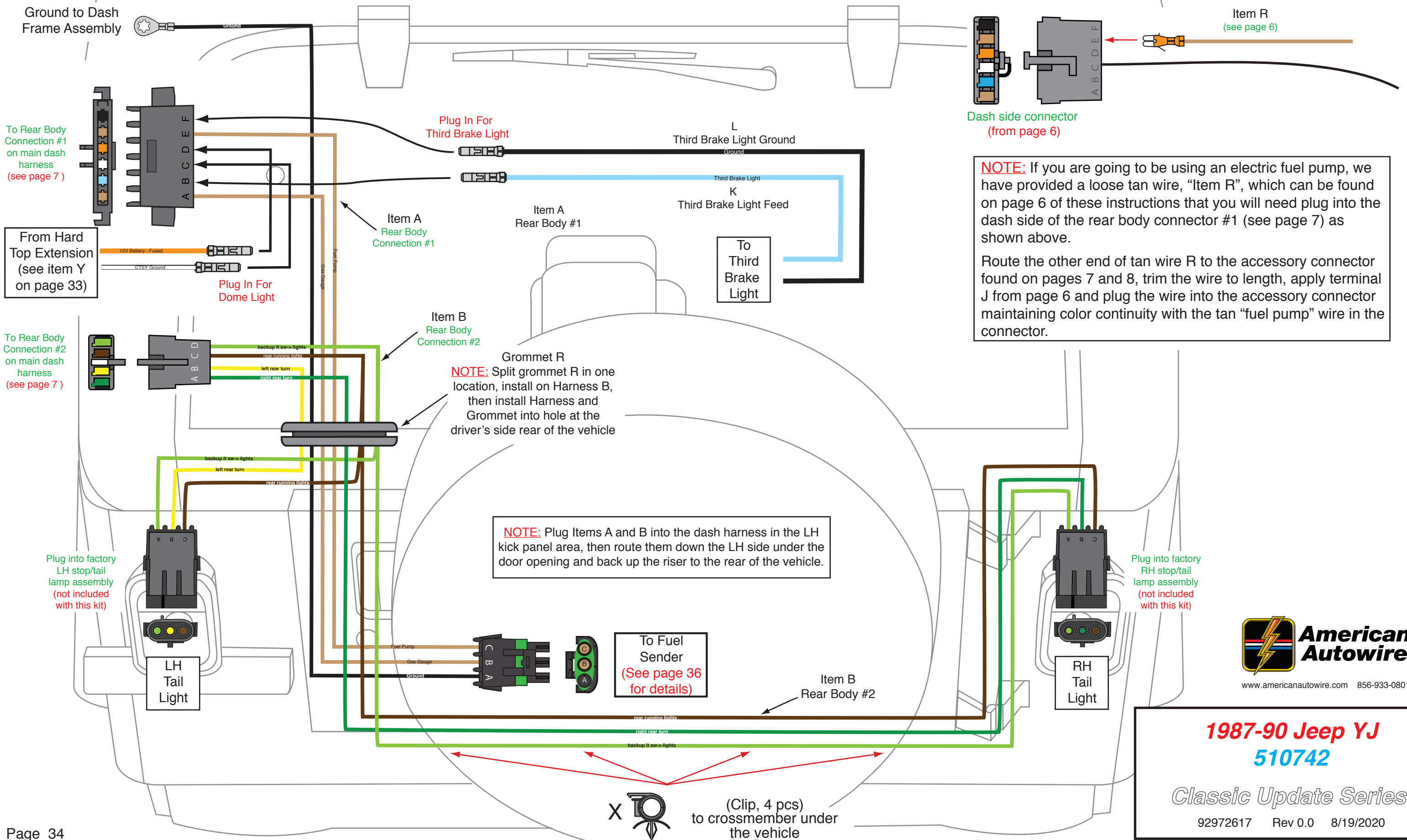

**NOTE:** If you are going to be using an electric fuel pump, we have provided a loose tan wire, "Item R", which can be found on page 6 of these instructions that you will need plug into the dash side of the rear body connector #1 (see page 7) as shown above.

Route the other end of tan wire R to the accessory connector found on pages 7 and 8, trim the wire to length, apply terminal J from page 6 and plug the wire into the accessory connector maintaining color continuity with the tan "fuel pump" wire in the connector.



www.americanautowire.com 856-933-0801

**1987-90 Jeep YJ**  
**510742**

*Classic Update Series*

92972617 Rev 0.0 8/19/2020

# 510746 Rear Body harness installation instructions:

## Factory hardtop wire harness installation instructions:

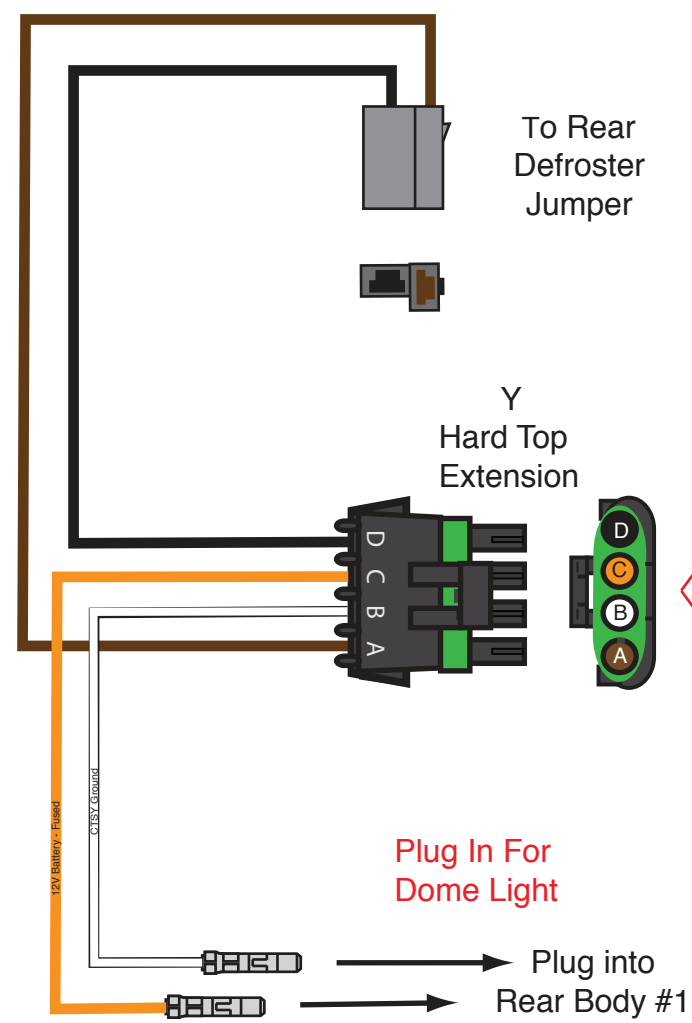

This connector routes to the front of the vehicle and will plug into the optional rear defroster harness (510797 available separately). If your vehicle does not have a rear defogger, this lead will not be used and can remain up under the dash.

This connector plugs into the original hardtop harness in the driver's side rear of the vehicle. **(not included in kit)**

These two wires and terminals route to the front of the vehicle and will plug into the main connector of rear body harness #1 as shown on page 34.

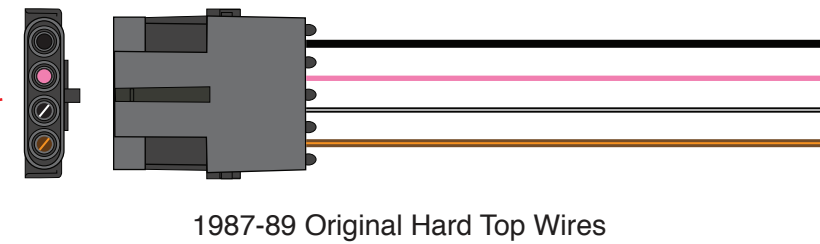

OR

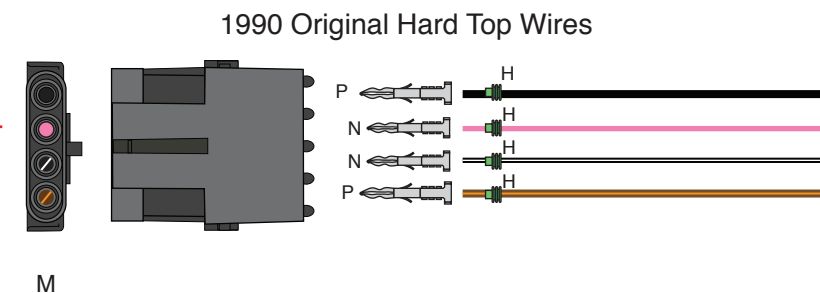

Existing connector already in place on the original hardtop harness **(not included in kit)**

Remove original 10-way connector from your 1990 hardtop harness and attach connector M, seals H and terminals N and P as shown. **(not included in kit)**



www.americanautowire.com 856-933-0801

**1987-90 Jeep YJ**  
**510742**

*Classic Update Series*

92972617 Rev 0.0 8/19/2020



# 510746 Rear Body harness installation instructions:

## Fuel tank sender and pump lead installation instructions:

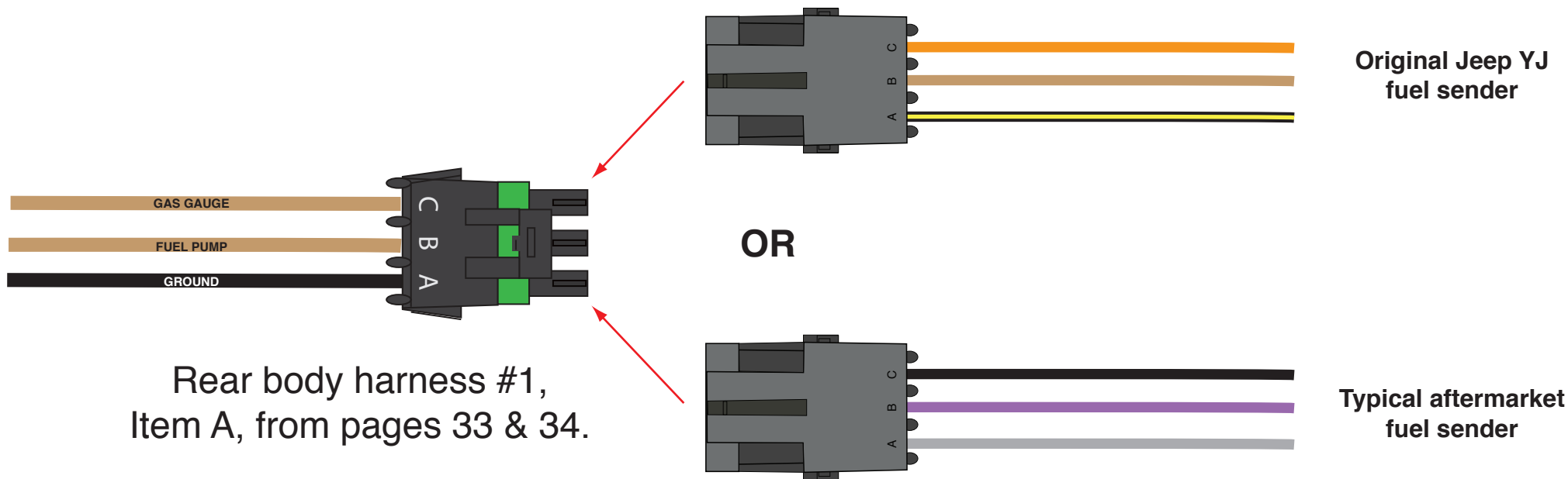

NOTE: There are a few different configurations on the stock fuel sender units for the 1987-1990 Jeep YJ's.

1. The rear body harness #1, "Item A" from pages 33 & 34 will plug directly into your existing sending unit (not included with this kit) with no modifications needed.
2. The 2.5 litre powered 4 cylinder vehicles (which this kit does not support) had an in-tank electric fuel pump. This kit will support an in-tank fuel pump just in case one has been added to your vehicle. Those sending units will have 3 wires in them. In addition, there are at least 2 known wiring configurations on these 3-wire sending units. We have included a visual at left, and a table below left, showing the different wiring configurations.
3. The stock 4.2 litre powered 6 cylinder vehicles did not use an in-tank electric fuel pump, so the fuel pump wire will just be unused at the fuel sender connection.

1987 - 1990 Jeep YJ Fuel Sender Pigtail Wire Pin-out

AAW		AAW	All	All	Original Sender	Aftermarket Sender
Circuit #	Wire Color	Printing	Circuit Description	Cavity #	Wire Color	Wire Color
150	Black	"GROUND"	Ground	A	Black/Yellow	Gray
30	Tan	"GAS GAUGE"	Gas gauge to fuel sender	B	Tan	Purple
103	Tan	"FUEL PUMP"	12v feed for in-tank fuel pump	C	Orange	Black



www.americanautowire.com 856-933-0801

**1987-90 Jeep YJ**  
**510742**

*Classic Update Series*

92972617 Rev 0.0 8/19/2020

# 510746 Rear Body harness installation instructions:

## Optional rear body power pass through installation instructions:

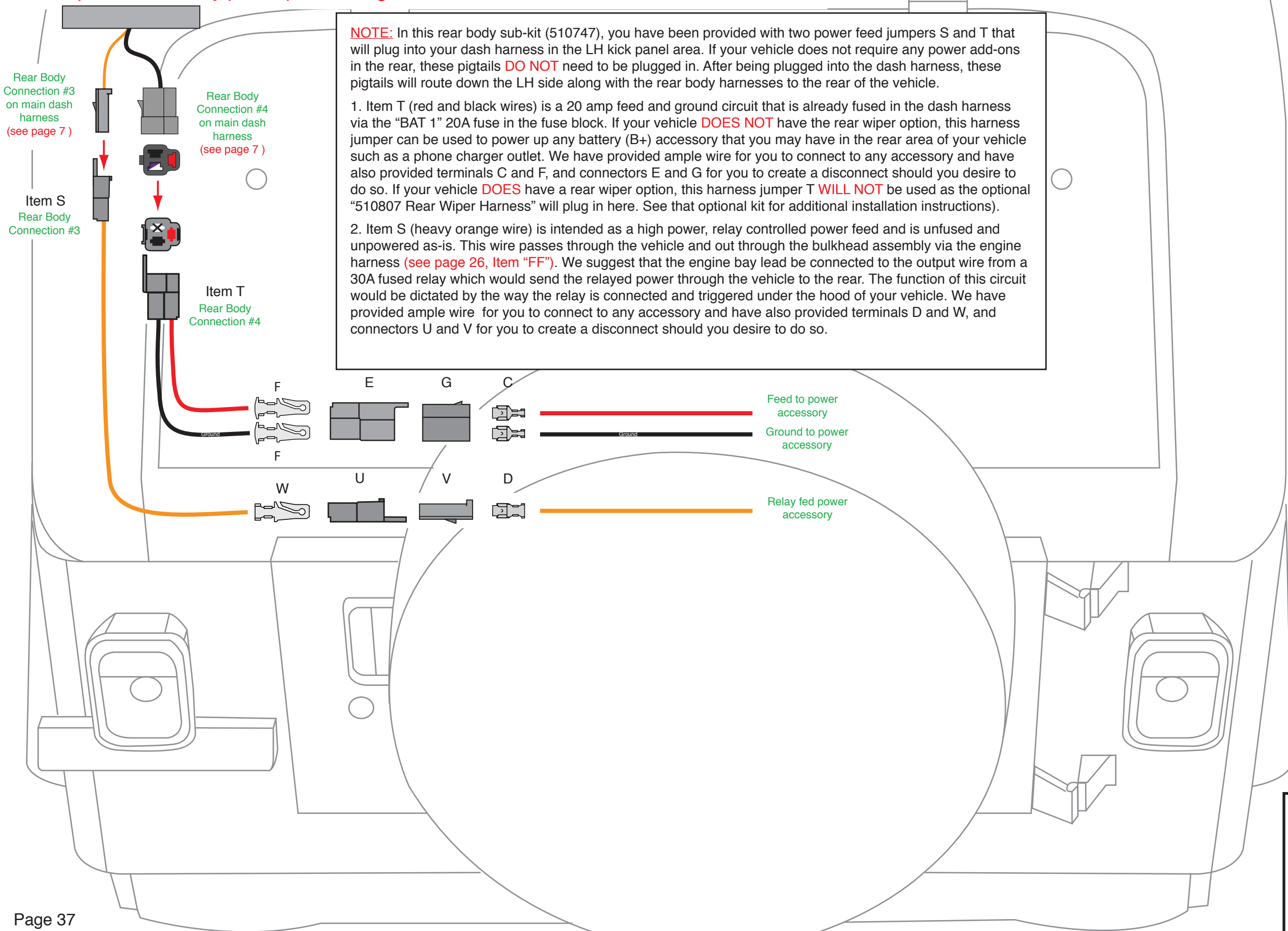

**NOTE:** In this rear body sub-kit (510747), you have been provided with two power feed jumpers S and T that will plug into your dash harness in the LH kick panel area. If your vehicle does not require any power add-ons in the rear, these pigtails **DO NOT** need to be plugged in. After being plugged into the dash harness, these pigtails will route down the LH side along with the rear body harnesses to the rear of the vehicle.

1. Item T (red and black wires) is a 20 amp feed and ground circuit that is already fused in the dash harness via the "BAT 1" 20A fuse in the fuse block. If your vehicle **DOES NOT** have the rear wiper option, this harness jumper can be used to power up any battery (B+) accessory that you may have in the rear area of your vehicle such as a phone charger outlet. We have provided ample wire for you to connect to any accessory and have also provided terminals C and F, and connectors E and G for you to create a disconnect should you desire to do so. If your vehicle **DOES** have a rear wiper option, this harness jumper T **WILL NOT** be used as the optional "510807 Rear Wiper Harness" will plug in here. See that optional kit for additional installation instructions).

2. Item S (heavy orange wire) is intended as a high power, relay controlled power feed and is unfused and unpowered as-is. This wire passes through the vehicle and out through the bulkhead assembly via the engine harness (see page 26, Item "FF"). We suggest that the engine bay lead be connected to the output wire from a 30A fused relay which would send the relayed power through the vehicle to the rear. The function of this circuit would be dictated by the way the relay is connected and triggered under the hood of your vehicle. We have provided ample wire for you to connect to any accessory and have also provided terminals D and W, and connectors U and V for you to create a disconnect should you desire to do so.



www.americanautowire.com 856-933-0801

**1987-90 Jeep YJ**  
**510742**

*Classic Update Series*

92972617 Rev 0.0 8/19/2020

THIS PAGE HAS INTENTIONALLY  
BEEN LEFT BLANK



[www.americanautowire.com](http://www.americanautowire.com) 856-933-0801

**1987-90 Jeep YJ**  
**510742**

*Classic Update Series*

92972617 Rev 0.0 8/19/2020