

# KENWOOD

MONITOR WITH DVD RECEIVER

## DDX6904S DDX6704S

---

### INSTRUCTION MANUAL

JVC KENWOOD Corporation

- Updated information (the latest Instruction Manual, system updates, new functions, etc.) is available from <http://www.kenwood.com/cs/ce/>.

**Take the time to read through this instruction manual.**

**Familiarity with installation and operation procedures will help you obtain the best performance from your new receiver.**

**For your records**

Record the serial number, found on the back of the unit, in the spaces designated on the warranty card, and in the space provided below. Refer to the model and serial numbers whenever you call upon your KENWOOD dealer for information or service on the product.

Model DDX6904S/ DDX6704S Serial number \_\_\_\_\_

***US Residence Only***

**Register Online**

Register your KENWOOD product at [www.kenwood.com/usa/](http://www.kenwood.com/usa/)

# Contents

## **Before Use 4**

Precautions.....	4
How to read this manual .....	5

## **Basic Operations 6**

Functions of the Buttons on the Front Panel ...	6
Turning on the Unit .....	7
Initial Settings.....	8
Adjusting the volume .....	9
Touch screen operations .....	9
HOME screen descriptions.....	10
Source selection screen descriptions.....	10
Source control screen descriptions .....	12
Popup menu .....	13
List screen .....	14

## **Disc 15**

Playing a disc .....	15
DVD/VCD Basic Operation.....	15
Music CD/ Disc media Basic Operation .....	17
Search Operation (Disc media only).....	18
DVD Disc Menu Operation.....	19
DVD Setup.....	20

## **USB 21**

Connecting a USB device .....	21
USB Basic Operation.....	21
Search Operation.....	23

## **iPod/iPhone 24**

Preparation .....	24
iPod/iPhone Basic Operation .....	25
Search Operation.....	26

## **APPS—Android Auto™/Apple CarPlay 27**

Apple CarPlay Operation .....	27
Android Auto™ Operation .....	28
Pandora® Operation .....	30
Spotify Operation.....	32

## **HD Radio™ Tuner 34**

HD Radio Tuner Basic Operation.....	34
Receive Mode .....	36
Memory Operation.....	36
Selecting Operation .....	37
Bookmark.....	38
Alert Message .....	40

## **SiriusXM® 41**

SiriusXM® Basic Operation .....	41
Storing Channels in Preset Memory.....	43
Preset select .....	43
Direct search .....	44
Category/Channel search.....	44
Replay.....	45
TuneMix™ .....	45
SmartFavorites, TuneStart™ .....	45
TuneScan™ .....	46
Traffic & Weather Now™ .....	46
Content Alerts.....	47
SportsFlash™ .....	47
SiriusXM Setup .....	48

**Bluetooth Control 53**

Information for using Bluetooth® devices.....53  
Register from the Bluetooth device.....54  
Bluetooth Setup.....55  
Playing Bluetooth Audio Device.....57  
Using Hands-Free Unit.....59  
Hands-Free Setup.....63

**Other External Components 64**

View Camera .....64  
Use Dashboard Camera.....65  
External audio/video players—AV-IN .....66  
OEM Features Operation .....66

**Setting Up 67**

Monitor Screen Setup.....67  
System Setup.....67  
User Interface Setup.....68  
Special Setup .....69  
Display Setup.....69  
AV Setup .....71

**Controlling Audio 72**

Speaker/ X'over setup .....72  
Controlling General Audio .....73  
Equalizer Control .....74  
Volume Offset.....75  
Zone Control .....75  
Sound Effect .....76  
Listening Position/ DTA.....77

**Remote control 79**

Battery Installation.....79  
Functions of the Remote control Buttons.....80

**Connection/Installation 83**

Before Installation .....83  
Installing the unit .....85

**Troubleshooting 91**

Problems and Solutions .....91  
Error Messages .....91

**Appendix 93**

Playable Media and Files.....93  
Region Codes in the World .....95  
DVD Language Codes.....96  
Specifications.....97  
About this Unit .....99

# Before Use

## Precautions

### ▲ WARNINGS

#### ■ To prevent injury or fire, take the following precautions:

- To prevent a short circuit, never put or leave any metallic objects (such as coins or metal tools) inside the unit.
- Do not watch or fix your eyes on the unit's display when you are driving for any extended period.
- If you experience problems during installation, consult your KENWOOD dealer.

#### ■ Precautions on using this unit

- When you purchase optional accessories, check with your KENWOOD dealer to make sure that they work with your model and in your area.
- You can select language to display menus, audio file tags, etc. See **User Interface Setup (P.68)**.
- The Radio Data System or Radio Broadcast Data System feature won't work where the service is not supported by any broadcasting station.
- The unit may not function properly if the connectors between the unit and front panel are dirty. Detach the front panel and clean the connector with a cotton swab gently, being careful not to damage the connector.

#### ■ Protecting the monitor

- To protect the monitor from damage, do not operate the monitor using a ball point pen or similar tool with the sharp tip.

#### ■ Cleaning the unit

- If the faceplate of this unit is stained, wipe it with a dry soft cloth such as a silicon cloth. If the faceplate is stained badly, wipe the stain off with a cloth moistened with neutral cleaner, then wipe it again with a clean soft dry cloth.

#### NOTE

- Applying spray cleaner directly to the unit may affect its mechanical parts. Wiping the faceplate with a hard cloth or using a volatile liquid such as thinner or alcohol may scratch the surface or erase screened print.

#### ■ Lens fogging

When you turn on the car heater in cold weather, dew or condensation may form on the lens in the disc player of the unit. Called lens fogging, this condensation on the lens may not allow discs to play. In such a situation, remove the disc and wait for the condensation to evaporate. If the unit still does not operate normally after a while, consult your KENWOOD dealer.

#### ■ Precautions on handling discs

- Do not touch the recording surface of the disc.
- Do not stick tape etc. on the disc, or use a disc with tape stuck on it.
- Do not use disc type accessories.
- Clean from the center of the disc and move outward.
- When removing discs from this unit, pull them out horizontally.
- If the disc center hole or outside rim has burrs, use the disc only after removing the burrs with a ballpoint pen etc.
- Discs that are not round cannot be used.

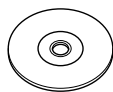

- 8-cm (3 inch) discs cannot be used.
- Discs with coloring on the recording surface or discs that are dirty cannot be used.

- This unit can only play the CDs with



- This unit may not correctly play discs which do not have the mark.
- You cannot play a disc that has not been finalized. (For the finalization process see your writing software, and your recorder instruction manual.)

## Acquiring GPS signal

The first time you turn on this unit, you must wait while the system acquires satellite signals for the first time. This process could take up to several minutes. Make sure your vehicle is outdoors in an open area away from tall buildings and trees for fastest acquisition.

After the system acquires satellites for the first time, it will acquire satellites quickly each time thereafter.

## Caution for Smartphone Users

Simultaneously running multiple applications on your smartphone while screen sharing places heavy demand on the microprocessor of the phone, potentially affecting communication and performance.

For best results while pairing with your Kenwood receiver, please be sure to close any unused applications by performing the following steps:

Android operating system example:

- Turn off WiFi in phone settings menu.
- Close all open applications before connecting for in-car use. Hold the <Home> key and select <Close all> to close all open applications.
- Clear RAM Memory of the Android phone before connecting for in-car use. Hold the <Home> key and select <Task Manager> then select <RAM> then select <Clear memory> to clear current memory processes.



<Home> Key

## How to read this manual

- The screens and panels shown in this manual are examples used to provide clear explanations of the operations. For this reason, they may be different from the actual screens or panels used, or some display patterns may be different.
- **Indication language:** English indications are used for the purpose of explanation. You can select the indication language from the **SETUP** menu. See **User Interface Setup (P.68)**.





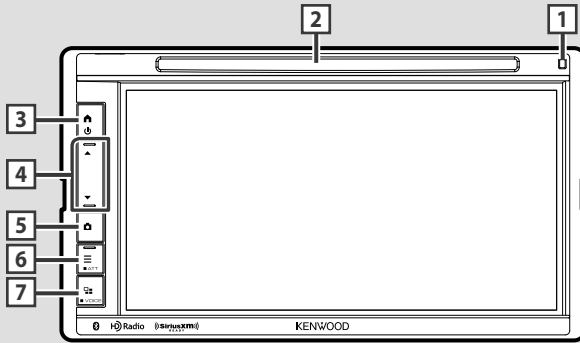

# Basic Operations

## Functions of the Buttons on the Front Panel



### NOTE

- The panels shown in this guide are examples used to provide clear explanations of the operations. For this reason, they may be different from the actual panels.

Number	Name	Motion
1	Remote Sensor	• Receives the remote control signal.
2	Disc insert slot	• A slot to insert a disc media.
3		<ul style="list-style-type: none"> <li>• Displays the HOME screen <b>(P.10)</b>.</li> <li>• Pressing for 1 second turns the power off. *</li> <li>• When the power off, turns the power on.</li> </ul> *The function of the button when held varies depending on the "Manual Power OFF" setting. <b>(P.69)</b>
4	 (Volume)	<ul style="list-style-type: none"> <li>• Adjusts volume.</li> <li>The volume will go up until 15 when you keep pressing .</li> </ul>
5		<ul style="list-style-type: none"> <li>• Switches view camera display on/off. <b>(P.64)</b> <ul style="list-style-type: none"> <li>– The camera whose view is displayed first changes according to the "Camera Setup" setting and the shift lever position in the shift gate.</li> </ul> </li> </ul>
6		<ul style="list-style-type: none"> <li>• Displays the popup menu screen.</li> <li>• Pressing for 1 second switches attenuation of the volume on/off.</li> </ul>
7		<ul style="list-style-type: none"> <li>• Displays the APP (CarPlay/ Android Auto) screen. Pressing this switch each time toggles between current source screen and APP screen.</li> <li>• Pressing for 1 second displays the Voice Recognition screen <b>(P.60)</b>.</li> </ul>

## Turning on the Unit

The method of turning on is different depending on the model.

- 1 Press the  button.

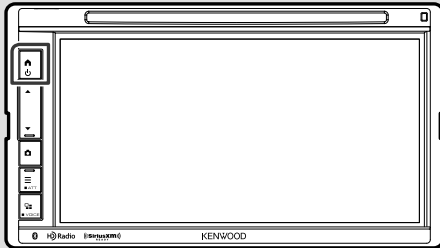

➤ The unit is turned on.

### ● To turn off the unit:

- 1 Press the  button for 1 second.

#### NOTE

- If it is your first time turning the unit on after installation, it will be necessary to perform Initial setup **(P.8)**.
- The function of the button when held varies depending on the "Manual Power OFF" setting. **(P.69)**

## Initial Settings

### Initial setup

Perform this setup when you use this unit first time.

#### 1 Set each item as follows.

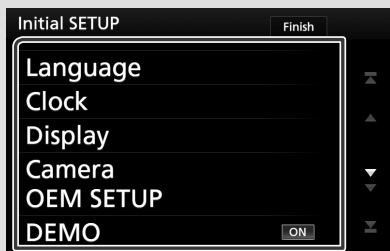

#### ■ Language

Select the language used for the control screen and setting items. Default is “American English (en)”.

- ① Touch **Language**.
- ② Touch **Language Select**.
- ③ Select the desired language.
- ④ Touch .

For detailed operation, see **User Interface Setup (P.68)**.

#### ■ Clock

Sets the synchronization of the clock and adjusts it.

For detailed operation, see **Calendar/clock settings (P.9)**.

#### ■ Display

Set the button illumination color.

If it is hard to see the image on the screen even, adjust the viewing angle.

- ① Touch **Display**.
- ② Touch **Key Color**.
- ③ Select the desired color.
- ④ Touch .
- ⑤ Touch **Viewing Angle**.
- ⑥ Select an angle
- ⑦ Touch .

For detailed operation, see **Display Setup (P.69)**.

#### ■ Camera

Set the parameters for the camera.

- ① Touch **Camera**.
- ② Set each item and touch .

For detailed operation, see **Camera Setup (P.64)**.

#### ■ OEM SETUP

This function requires a commercial adaptor. Consult your KENWOOD dealer for details.

#### ■ DEMO

Set the demonstration mode. Default is “ON”.

- ① Touch **DEMO** and set ON or OFF.

#### 2 Touch Finish.



#### NOTE

- These settings can be set from the SETUP menu. See **Setting Up (P.67)**.



## Calendar/clock settings

- 1 Press the  button.  
 > Popup menu appears.

- 2 Touch **SETUP**.



- > SETUP Menu screen appears.

- 3 Touch **User Interface**.

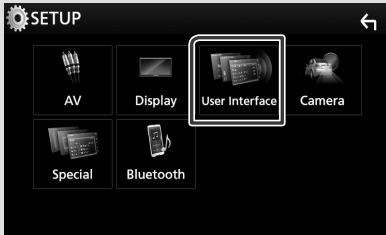

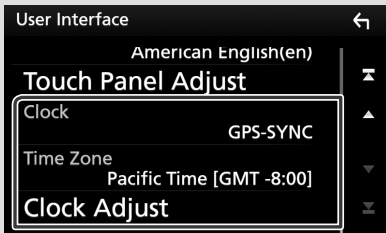

- > User Interface screen appears.

- 4 Set each item as follows.  
 Scroll the page to show the item.



- **Clock**  
**GPS-SYNC** (Default): Synchronizes the clock time with the GPS.  
**Manual**: Sets the clock manually.
- **Time Zone**  
 Select the time zone.
- **Clock Adjust**  
 If you select **Manual** for Clock, adjust the date and time manually. (P.68)

## Adjusting the volume

To adjust the volume (0 to 40),  
 Press  to increase, and press  to decrease.  
 Holding  increases the volume continuously to level 15.

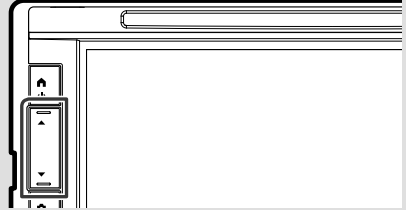

## Touch screen operations

To perform operations on the screen, you need to touch, touch and hold, flick or swipe to select an item, display setting menu screen or to change the page, etc.

### ● Touch

Touch the screen gently to select an item on the screen.

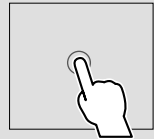

### ● Touch and hold

Touch the screen and keep your finger in place until the display changes or a message is displayed.

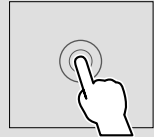

### ● Flick

Slide your finger quickly to the left or right on the screen to change the page.  
 You can scroll the list screen by flicking the screen up/down.

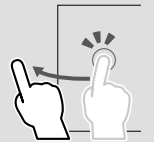

### ● Swipe

Slide your finger up or down on the screen to scroll the screen.

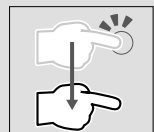



## Basic Operations

### HOME screen descriptions

Most functions can be performed from the HOME screen.



- 1 • Displays the control screen of current source.  
• The artwork is displayed if available from current content.
- 2 • Widget  
– You can change the widget by touching   or flicking left or right on the widget area.  
– Touch the widget to display the detailed screen.
- 3 • Page indication for widgets
- 4 • Current source information
- 5 • Displays the source selection screen. **(P.11)**
- 6 • Short-cut playback source icons **(P.11)**
- 7 • Displays the Hands Free screen. **(P.59)**  
• When connecting as Apple CarPlay or Android Auto, it works as a phone provided in Apple CarPlay or Android Auto.

### Display the HOME

- 1 Press the  button.

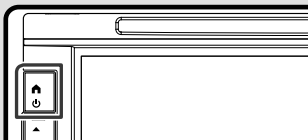



- HOME screen appears.

### Source selection screen descriptions

You can display all playback sources and options on the source selection screen.



- 1 • Changes the playback source.  
For playback sources, see **P.11**.
- 2 • Changes the page. (Touch  .)  
You can also change the page by flicking left or right on the screen.
- 3 • Returns to previous screen.
- 4 • Page indication
- 5 • Displays the SETUP Menu screen. **(P.67)**

## Select the playback source

### 1 Touch on the HOME screen.

From the screen, you can select the following sources and functions.

	• Switches to the Android Auto/ Apple CarPlay screen from the connected iPod touch/iPhone/Android device.*1 (P.27)
	
	• Switches to the HD Radio broadcast. (P.34)
	• Switches to the SiriusXM® satellite radio broadcast. (P.41)
	• Plays a Bluetooth audio player. (P.53)
	• Plays a disc. (P.15)
	• Plays an iPod/iPhone. (P.24)
	• Plays files on a USB device. (P.21)
	• Switches to the Pandora. (P.30)
	• Switches to the Spotify. (P.32)
	• Switches to an external component connected to the AV-IN input terminal. (P.66)
	• Displays the Audio screen. (P.72)
	• Puts the unit in standby. (P.12)

\*1 When iPhone compatible with CarPlay is connected, **Apple CarPlay** is displayed. When an Android device compatible with Android Auto is connected, **Android Auto** is displayed.

- For sources and information displayed when an ADS adapter is connected, see **OEM Features Operation (P.66)**.

### To select the playback source on the HOME screen

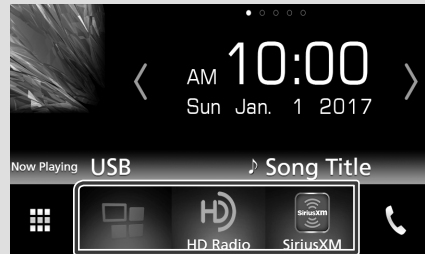



The 3 items displayed on the source selection screen as the large icons are shown on the HOME screen.

You can change items displayed on this area by customizing the source selection screen. (P.12)

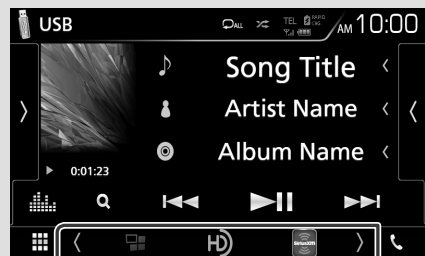
### To select the playback source on the source control screen



Display source selection buttons by touching  or  or flicking left or right on the source control screen, then select a playback source.

## Put the unit in standby

- 1 Touch  on the HOME screen.
- 2 Touch **STANDBY**.



## Customize Short-cut buttons on HOME screen

You can arrange the position of the source icons as you like.

- 1 Touch  on the HOME screen.
- 2 Touch and hold the icon which you want to move to go into the customizing mode.
- 3 Drag it where you want to move.



Changes the page

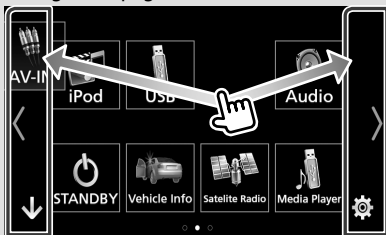

## Source control screen descriptions

There are some functions which can be operated from most screens.

### Indicators

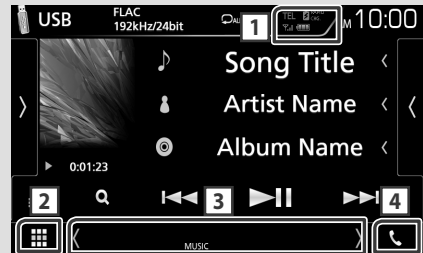

### Short-cut buttons



- 1 TEL    

- Connected Bluetooth device information.
-  : Lights up when quick charging battery of the connected iPod/ iPhone/ Smartphone.

- 2  **All sources icon**

Displays all sources.

- 3 **Secondary screen**

-  : The Secondary screen changes every time you touch it. You can also change the Secondary screen by flicking left or right on the screen.
- Indicators: Displays the current source condition and so on.
  - **ATT**: The attenuator is active.
  - **DUAL**: The dual zone function is on.
  - **MUTE**: The mute function is active.
  - **LOUD**: The loudness control function is on.
- Short-cut buttons: The source changes to the one you have set as a short-cut. For the short-cut setting, refer to **Customize Short-cut buttons on HOME screen (P.12)**.

- 4 

Touch to display the Hands Free screen. **(P.59)**

When connecting as Apple CarPlay or Android Auto, it works as a phone provided in Apple CarPlay or Android Auto.

## Popup menu

- 1 Press the  button.

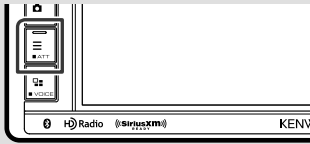









➤ Popup menu appears.

- 2 Touch to display the popup menu.



The contents of the menu are as follows.

	• Displays the Screen Adjustment screen. <b>(P.67)</b>
	• Turns the display off. <b>(P.9)</b>
	• Displays the view camera. <b>(P.64)</b>
	• Displays the SETUP Menu screen. <b>(P.67)</b>
	• Displays the Audio Control Menu screen. <b>(P.72)</b>
	• Displays the control screen of current source. Icon feature differs depending on the source.
	• Close the popup menu.
	• See <b>HOME screen descriptions (P.10)</b> .
	• Ejects the disc. • To forcibly eject the disc, press it for 2 seconds and touch <b>Yes</b> after the message is displayed.

## Turn off the screen

- 1 Select **Display OFF** on the popup menu.



## List screen

There are some common function keys in the list screens of most sources.



Displays list type selection window.



Displays music/movie file list.



Scrolls the displayed text.



Keys with various functions are displayed here.

- **Play**: Plays all tracks in the folder containing the current track.
- **A-Z**: Jump to the letter you entered (alphabet search).
- **Top** / **Up**: Moves to the upper hierarchy.



You can change the page to display more items by pressing / .

- / : Displays the top or bottom page.



Returns to previous screen.

### NOTE

- Buttons which cannot be activated from the list screen are not displayed.

# Disc

## Playing a disc

### Insert a disc

#### 1 Insert the disc into the slot.

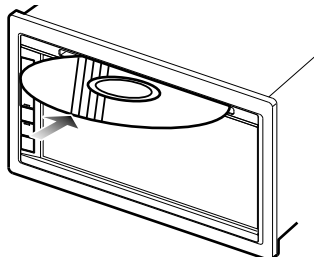

- ▶ The unit loads the disc and playback starts.

### Eject a disc

#### 1 Press the button.

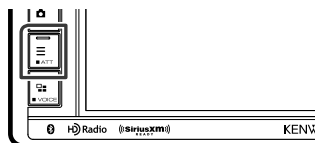

#### 2 Touch .

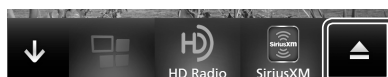

When removing a disc, pull it horizontally.

### NOTE

- This is not displayed on the popup menu screen of Apple CarPlay or Android Auto source. Change Apple CarPlay or Android Auto source to other one to display the popup menu screen.

## DVD/VCD Basic Operation

Most functions can be controlled from the source control screen and playback screen.

### NOTE

- Set the remote control mode switch to DVD mode before starting operation for DVD and VCD, see **Switch the operation mode (P.80)**.
- The screen shot below is for DVD. It may be different from the one for VCD.

#### 1 When the operation buttons are not displayed on the screen, touch the area.

### Control screen

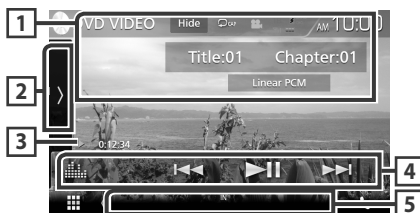

### Video screen









#### 1 Information display

Displays the following information.

- Title #, Chapter #:** DVD title and chapter number display
- Track #/Scene #:** VCD track or scene number display. Scene # is displayed only when Playback control (PBC) is on.
- Linear PCM, etc.:** Audio format
- Hide:** Hides the control screen.







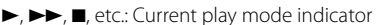

## Disc

- : Repeats the current content. Each time you touch the key, repeat mode switches in the following sequence;  
**DVD**: Title repeat (  ), Chapter repeat (  ), Repeat off (  )  
**VCD (PBC On)**: Does not repeat  
**VCD (PBC Off)**: Track repeat (  ), Repeat off (  )



### 2 Function panel

Touch on the left side of the screen to display the function panel. Touch again to close the panel. For details on the keys, see **Function panel (P.16)**.

### 3 Play mode indicator/ Playing time

- : Current play mode indicator  
The meanings of each icon are as follows;  
 (play),  (fast forward),  
 (fast backward),  (stop),  (resume stop),  
 (pause),  (slow playback),  
 (slow reverse playback).

### 4 Function bar

- : Searches the previous/next content.  
Touch and hold to fast forward or fast backward.
- : Plays or pauses.
- : Displays the Graphic Equalizer screen. (P.74)

### 5 Indicator Items

- **IN**: A disc is inserted.  
White: A Disc is inside the unit.  
Orange: Error at the disc player

## VCD

- **1chLL/2chLL**: Identifies the left audio output of channel 1 or 2.
- **1chLR/2chLR**: Identifies the monaural audio output of channel 1 or 2.
- **1chRR/2chRR**: Identifies the right audio output of channel 1 or 2.
- **1chST/2chST**: Identifies the stereo audio output of channel 1 or 2.
- **LL**: Identifies the left audio output.
- **LR**: Identifies the monaural audio output.
- **RR**: Identifies the right audio output.
- **ST**: Identifies the stereo audio output.
- **PBC**: The PBC function is on.
- **VER1**: The VCD version is 1.
- **VER2**: The VCD version is 2.

### 6 Searching area

Touch to search the next/previous content.

### 7 Key display area

Touch to display the control screen.

### 8 MENU CTRL (DVD only)

Touch to display the DVD-VIDEO disc menu control screen. See **DVD Disc Menu Operation (P.19)**.

#### NOTE

- The control screen disappears when no operation is done for 5 seconds.
- If you use a remote control, you can jump directly to the desired image with entering the chapter number, scene number, play time, etc. (P.80).

## Function panel

### 1 Touch on the left side of the screen.

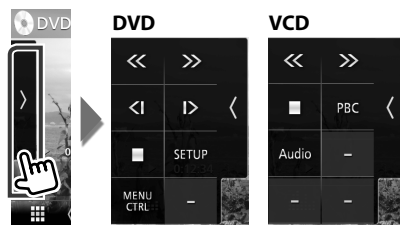

The functions of each key are as follows.



Stops playback. When touched twice, the disc is played from the beginning when you play it the next time.



Fast forward or fast backward. Each time you touch the key, the speed changes; 2 times, 8 times.

### or (DVD only)

Plays in slow motion forward or backward.

### SETUP (DVD only)

Touch to display the DVD SETUP screen. See **DVD Setup (P.20)**.

### MENU CTRL (DVD only)

Touch to display the DVD-VIDEO disc menu control screen. See **DVD Disc Menu Operation (P.19)**.



**PBC (VCD only)**

Turn Playback control (PBC) on or off.

**Audio (VCD only)**

Change the audio output channel.





## Music CD/ Disc media Basic Operation

Most functions can be controlled from the source control screen and playback screen.

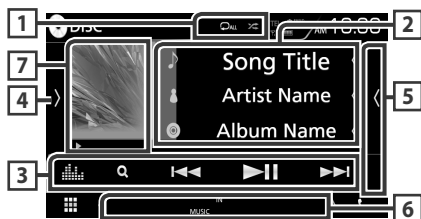

**NOTE**

- Set the remote controller mode switch to AUD mode before starting operation for Music CD and audio files, see **Switch the operation mode (P.80)**.
- In this manual, "Music CD" will be referred to as the general CDs which include music tracks in. "Disc media" will be referred to as CD/DVD disc which includes audio or video files.
- The screen shot below is for disc media. It may be different from the one for CD.

**Control screen****Content list panel****1**  / 

-  : Repeats the current track/folder. Each time you touch the key, repeat mode switches in the following sequence; Track/ File repeat (  ), Folder repeat (  ) (Disc media only), Repeat all (  )
-  : Randomly plays all tracks in current folder/disc. Each time you touch the key,





random mode switches in the following sequence;

Track random (  ) (Music CD only), Folder random (  ) (Disc media only), Random off (  )

**2** **Track information**

Displays the information of the current track/ file. Only a file name and a folder name are displayed if there is no tag information. (Disc media only)

**3** **Function bar**

-  (Disc media only) : Searches file. For details on search operation, see **File search (P.18)**.
-  : Searches the previous/next content. Touch and hold to fast forward or fast backward.
-  : Plays or pauses.
-  : Displays the Graphic Equalizer screen. (P.74)

**4** **Function panel (Disc media only)**

Touch on the left side of the screen to display the function panel. Touch again to close the panel.

-   : Searches previous/next folder.

**5** **Content list**

Touch on the right side of the screen to display the Content list. Touch again to close the list.

**6** **Indicator Items**

- **IN**: A disc is inserted.  
White: A Disc is inside the unit.  
Orange: Error at the disc player
- **VIDEO**: Identifies the video file.
- **MUSIC**: Identifies the music file.

**7** **Artwork (Disc media only) /Play mode indicator/ Playing time**

The jacket of the currently playing file is displayed.

- ▶, ▶▶, etc.: Current play mode indicator
- The meanings of each icon are as follows; ▶ (play), ▶▶ (fast forward), ◀◀ (fast backward), || (pause).

**8** **Content list panel**

Displays the playing list. When you touch a track/ file name on the list, playback will start.

## Video screen

**9 Searching file area (Video file only)**

Touch to search the next/previous file.

**10 Key display area (Video file only)**

Touch to display the control screen.

## Search Operation (Disc media only)

You can search music or video files by the following operations.

**NOTE**

- If you use a remote control, you can jump directly to the desired track with entering the track number. For details, see **Direct search mode (P.80)**.

### File search

You can search a file according to hierarchy.

- 1 Touch **Q**.  
➤ Folder List screen appears.
- 2 Touch the desired folder.

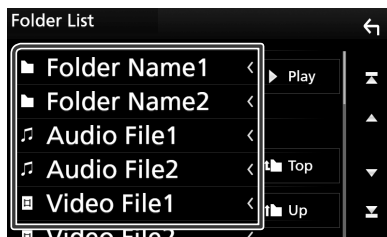

- When you touch a folder its contents are displayed.
- 3 Touch desired item from the content list.  
➤ Playback starts.

**NOTE**

- For operations in the list screen, see **List screen (P.14)**.

## DVD Disc Menu Operation

You can set up some items in the DVD-VIDEO disc menu.

### 1 Touch illustrated area during playback.



➤ Menu Control screen appears.

### 2 Perform desired operation as follows.

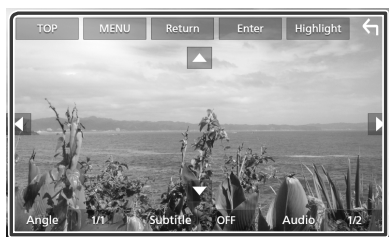

#### ■ Displays the top menu

Touch **TOP**.\*

#### ■ Displays the menu

Touch **MENU**.\*

#### ■ Displays the previous menu

Touch **Return**.\*

#### ■ Enters selected item

Touch **Enter**.

#### ■ Enables direct operation

Touch **Highlight** to enter the highlight control mode (P.19).

#### ■ Moves the cursor

Touch ▲, ▼, ◀, ▶.

#### ■ Switches the subtitle language

Touch **Subtitle**. Each time you touch this key, language is switched.

#### ■ Switches the audio language

Touch **Audio**. Each time you touch this key, language is switched.

#### ■ Switches the picture angle

Touch **Angle**. Each time you touch this key, picture angle is switched.

\*These keys may not function depending on the disc.

### Highlight control

Highlight control lets you control the DVD menu by touching the menu key directly on the screen.

#### 1 Touch **Highlight** in the Menu Control screen.

#### 2 Touch desired item on the screen.



#### NOTE

- The highlight control is cleared automatically if you do not operate for a constant time.

## DVD Setup

You can set up the DVD playback functions.

### 1 Touch illustrated area during playback.

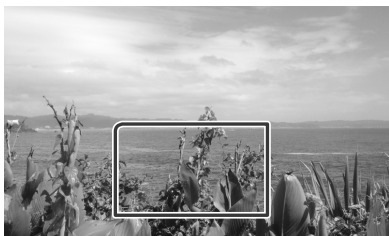

### 2 Touch on the left side of the screen. Touch **SETUP**.

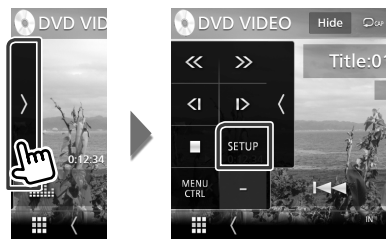

▶ DVD SETUP screen appears.

### 3 Set each item as follows.

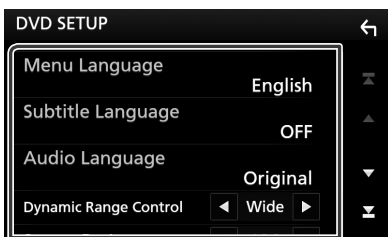

#### ■ **Menu Language / Subtitle Language / Audio Language**

See **Language setup (P.20)**.

#### ■ **Dynamic Range Control**

Sets the dynamic range.

**Wide:** The dynamic range is wide.

**Normal:** The dynamic range is normal.

**Dialog** (Default): Makes the total sound volume larger than other modes. This is effective only when you are using Dolby Digital software.

#### ■ **Screen Ratio**

Sets the screen display mode.

**16:9** (Default): Displays wide pictures.

**4:3 LB:** Displays wide pictures in the Letter Box format (having black stripes at the top and bottom of screen).

**4:3 PS:** Displays wide pictures in the Pan & Scan format (showing pictures cut at the right and left ends).

#### ■ **Language setup**

This setting is for the language used in the menu, subtitle, and voice.

### 1 Touch the desired item; **Menu Language, Subtitle Language, Audio Language.**

▶ Language Set screen appears.

### 2 Select a language.

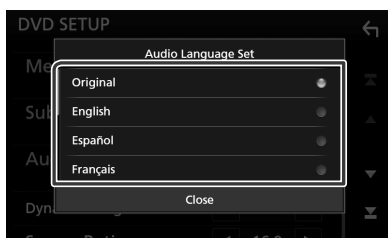

For language code, refer to **DVD Language Codes (P.96)**.

Sets the entered language and returns to the DVD Setting screen.

#### **NOTE**

- To set the DVD's original language for audio language, touch **Original**.

# USB

## Connecting a USB device

- 1 Connect the USB device with the USB cable. (P.89)

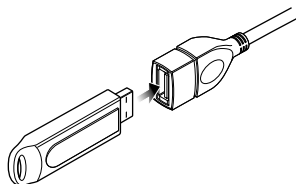

- 2 Press the **Home** button.
- 3 Touch **Grid**.
- 4 Touch **USB**. (P.11)

### Disconnect the USB device

- 1 Press the **Home** button.
- 2 Touch a source other than **USB**.
- 3 Detach the USB device.

### Usable USB device

You can use a mass-storage-class USB device on this unit.

The word "USB device" appearing in this manual indicates a flash memory device.

#### ● About file system

The file system should be the one of the following.

- FAT16
- FAT32
- exFAT
- NTFS

#### NOTE

- Install the USB device in the place where it will not affect safe driving.
- You cannot connect a USB device via a USB hub and Multi Card Reader.
- Take backups of the audio files used with this unit. The files can be erased depending on the operating conditions of the USB device. We shall have no compensation for any damage arising from any erased data.

## USB Basic Operation

Most functions can be controlled from the source control screen and playback screen.

#### NOTE

- Set the remote controller mode switch to AUD mode before starting operation, see **Switch the operation mode (P.80)**.

#### Control screen

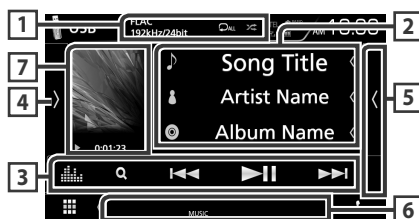

#### Content list panel



- **Repeat**: Repeats the current track/folder. Each time you touch the key, repeat mode switches in the following sequence; File repeat ( ), Folder repeat ( ), Repeat all ( )
- **Shuffle**: Randomly plays all tracks in current folder. Each time you touch the key, random mode switches in the following sequence; File random ( ), Random off ( )
- When a high-resolution source is played, its format information is displayed.

#### 2 Track information

Displays the information of the current file.

Only a file name and a folder name are displayed if there is no tag information.

### 3 Function bar

- **Q** : Searches track/file. For details on search operation, see **Search Operation (P.23)**.
- **◀◀ ▶▶** : Searches the previous/next track/file.  
Touch and hold to fast forward or fast backward.
- **▶||** : Plays or pauses.
- **📊** : Displays the Graphic Equalizer screen. **(P.74)**

### 4 Function panel

Touch on the left side of the screen to display the function panel. Touch again to close the panel.

- **🏠 +** : Searches previous/next folder.
- **USB DEVICE CHANGE (DDX6904S)**  
Switches to another USB device when two USB devices are connected.

### 5 Content list

Touch on the right side of the screen to display the Content list. Touch again to close the list.

### 6 Indicator Items

- **VIDEO**: Identifies the video file.
- **MUSIC**: Identifies the music file.

### 7 Artwork/ Play mode indicator/ Playing time

The jacket of the currently playing file is displayed.

- **▶, ▶▶, etc.**: Current play mode indicator  
The meanings of each icon are as follows;  
▶ (play), ▶▶ (fast forward), ◀◀ (fast backward), || (pause).

### 8 Content list panel

Displays the playing list. When you touch a track/file name on the list, playback will start.

Video screen



### 9 Searching file area (Video file only)

Touch to search the next/previous file.

### 10 Key display area (Video file only)

Touch to display the control screen.

## Search Operation

You can search music or video files by the following operations.

- 1 Touch **Q**.
- 2 Touch **▼**.



- 3 Select the list type.

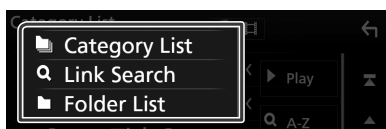

### NOTE

- For operations in the list screen, see **List screen (P.14)**.

## Category search

You can search a file by selecting category.

- 1 Touch **Category List**.
- 2 Select whether you search by audio files or video files .
- 3 Touch the desired category.

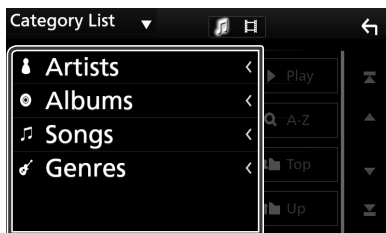

- The list corresponding to your selection appears.

- 4 Touch to select desired item in the list. Repeat this step until you find the desired file.

## Link search

You can search a file of same artist/album/genre as the current track.

- 1 Touch **Link Search**.
- 2 Touch the desired tag type. You can select from artist, album and genre.

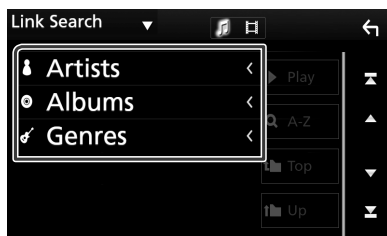

- The list corresponding to your selection appears.

- 3 Touch desired item from the content list.

## Folder search

You can search a file according to hierarchy.

- 1 Touch **Folder List**.



- 2 Touch the desired folder.

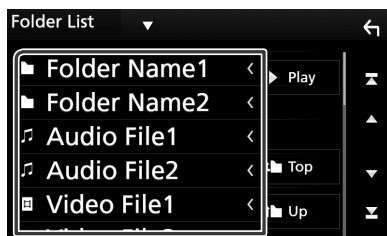

When you touch a folder its contents are displayed.

- 3 Touch to select desired item in the list. Repeat this step until you find the desired file.

# iPod/iPhone

## Preparation

### Connectable iPod/iPhone

The following models can be connected to this unit.

Made for

- iPhone 6s Plus
- iPhone 6s
- iPhone 6 Plus
- iPhone 6
- iPhone 5s
- iPhone 5c
- iPhone 5
- iPod touch (6th generation)
- iPod touch (5th generation)

#### NOTE

- Latest compatible list of iPod/iPhone. For details, see [www.kenwood.com/cs/ce/ipod/](http://www.kenwood.com/cs/ce/ipod/).
- By connecting your iPod/iPhone to this unit with an optional accessory iPod connection cable KCA-iP103, you can supply power to your iPod/iPhone as well as charge it while playing music. However, the power of this unit must be on.
- If you start playback after connecting the iPod, the music that has been played by the iPod is played first.

### Connect iPod/iPhone

#### Wired connection

##### Preparation

- Connect an iPod/iPhone with the KCA-iP103 (optional accessory) while CarPlay is not connected.
- With a CarPlay-capable iPhone, turn off CarPlay by operating the iPhone at functional setup before connecting iPhone. For details of the setup method, contact the manufacturer of the terminal.
- DDX6904S: Plug the iPod/iPhone into the gray USB terminal with the KCA-iP103 (optional accessory).
- Only one iPod/iPhone can be connected.

#### 1 Connect the iPod/iPhone using KCA-iP103. (P.90)

#### 2 Press the button.

#### 3 Touch .

#### 4 Touch iPod. (P.11)

#### ● To disconnect the iPod/iPhone connected with the cable:

#### 1 Detach the iPod/iPhone.

#### Bluetooth connection

Pair the iPhone through Bluetooth.

##### Preparation

- To connect an iPhone via Bluetooth, register it as the Bluetooth device and do the profile setting of the connection beforehand. See **Register from the Bluetooth device (P.54)** and **Connect the Bluetooth device (P.56)**.
- Connect an iPhone on Bluetooth while CarPlay and an iPod/iPhone are not connected on USB.



## iPod/iPhone Basic Operation

### NOTE

- Set the remote controller mode switch to AUD mode before starting operation, see **Switch the operation mode (P.80)**.

### Control screen

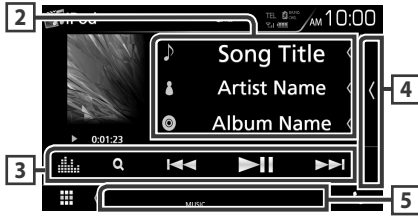

### Content list panel



- **Repeat** (⏮): Repeats the current track/album. Each time you touch the key, repeat mode switches in the following sequence; Song repeat (⏮), All songs repeat (⏮<sub>All</sub>)
- **Shuffle** (⏭): Randomly plays all tracks in current album. Each time you touch the key, random mode switches in the following sequence; Song random (⏭), Album random (⏭<sub>All</sub>), Random off (⏭)

### 2 Track information

- Displays the information of the current file.
- Touch to display the category list screen. See **Category search (P.26)**.

### 3 Function bar

- **Search** (🔍): Searches track/file. For details on search operation, see **Search Operation (P.26)**.
- **Fast Forward/Backward** (⏮ ⏭): Searches the previous/next track/file. Touch and hold to fast forward or fast backward.
- **Play/Pause** (▶ ||): Plays or pauses.
- **Graphic Equalizer** (📊): Displays the Graphic Equalizer screen. (P.74)

### 4 Content list

Touch on the right side of the screen to display the Content list. Touch again to close the list.

### 5 Indicator Items

- **MUSIC**: Identifies the music file.

### 6 Artwork/ Play mode indicator/ Playing time

The jacket of the currently playing file is displayed.

- **Play mode indicators**: Current play mode indicator  
The meanings of each icon are as follows;  
▶ (play), ▶▶ (fast forward),  
▶▶▶ (play), ▶▶▶▶ (fast forward),  
◀◀ (fast backward), || (pause).

### 7 Content list panel

Displays the playing list. When you touch a track/file name on the list, playback will start.

## Search Operation

You can search music files by the following operations.

1 Touch **Q**.

2 Touch **▼**.



3 Select the list type.

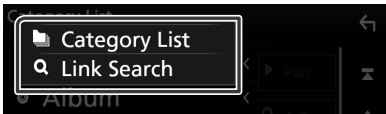

### NOTE

- For operations in the list screen, see [List screen \(P.14\)](#).

## Category search

You can search a file by selecting category.

1 Touch **Category List**.

2 Touch the desired category.

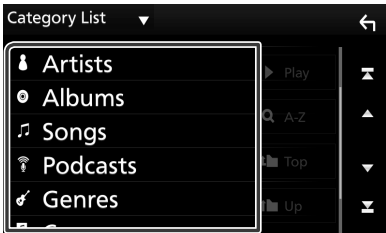

➤ The list corresponding to your selection appears.

3 Touch to select desired item in the list.  
Repeat this step until you find the desired file.

## Link search

You can search a file of same artist/album/genre/composer as the current track.

1 Touch **Link Search**.

2 Touch the desired tag type. You can select from artist, album, genre and composer.

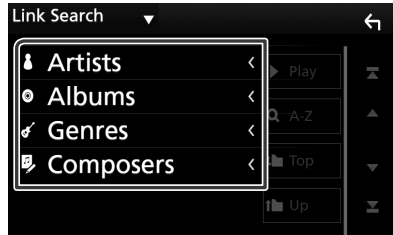

➤ The list corresponding to your selection appears.

3 Touch desired item from the content list.

# APPS—Android Auto™/Apple CarPlay

## Apple CarPlay Operation

CarPlay is a smarter, safer way to use your iPhone in the car. CarPlay takes the things you want to do with iPhone while driving and displays them on the screen of the product. You can get directions, make calls, send and receive messages, and listen to the music from iPhone while driving. You can also use Siri voice control to make it easier to operate iPhone.

For details about CarPlay, visit <https://ssl.apple.com/ios/carplay/>.

### Compatible iPhone devices

You can use CarPlay with the following iPhone models.

- iPhone 6s Plus
- iPhone 6s
- iPhone 6 Plus
- iPhone 6
- iPhone 5s
- iPhone 5c
- iPhone 5

## Preparation

### 1 Connect iPhone using KCA-iP103 via USB (Black) terminal. (P.90)

When iPhone compatible with CarPlay is connected to the USB (Black) terminal, the Bluetooth smartphone currently connected is disconnected.

### 2 Unlock your iPhone.

## Operation buttons and available Apps on the home screen of CarPlay

You can use the Apps of the connected iPhone. The items displayed and the language used on the screen differ among the connected devices.

To enter CarPlay mode, touch **Apple CarPlay** icon in the source selection screen. (P.11)

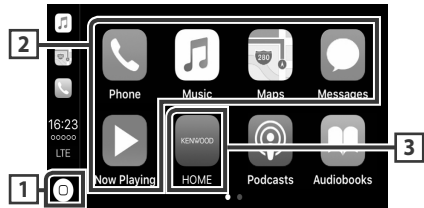

### 1 Siri

- Displays the home screen of CarPlay.
- Touch and hold to activates Siri.

### 2 Application buttons

Starts the application.

### 3 HOME

Exits the CarPlay screen and displays the Home screen.

### To exit the CarPlay screen

- 1 Press the  button.

## Use Siri

You can activate Siri.

- 1 Press the  button for 1 second.

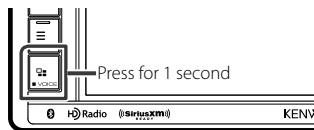

- 2 Talk to Siri.

### To deactivate

- 1 Press the  button.

## Switch to the Apple CarPlay screen while listening to another source

- 1 Press the  button.

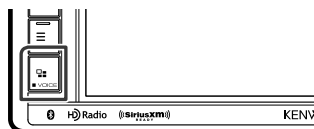

### NOTE

- If sound is output using Apple CarPlay when the Apple CarPlay screen is displayed, the source is switched to Apple CarPlay.

## Android Auto™ Operation

Android Auto enables you to use functions of your Android device convenient for driving. You can easily access route guidance, make calls, listen to music, and access convenient functions on the Android device while driving. For details about Android Auto, visit <https://www.android.com/auto/> and <https://support.google.com/androidauto>.

### Compatible Android devices

You can use Android Auto with Android devices of Android version 5.0 (Lollipop) or later.

### NOTE

- Android Auto may not be available on all devices and is not available in all countries or regions.

## Preparation

- 1 Connect an Android device via USB terminal. (*P.90*)

To use the hands-free function, connect the Android device via Bluetooth.

When an Android device compatible with Android Auto is connected to the USB terminal, the device is connected via Bluetooth automatically, and the Bluetooth smartphone currently connected is disconnected.

- 2 Unlock your Android device.

## Operation buttons and available Apps on the Android Auto screen

You can perform the operations of the Apps of the connected Android device.

The items displayed on the screen differ among the connected Android devices.

To enter Android Auto mode, touch **Android Auto** icon in the source selection screen. (P.11)

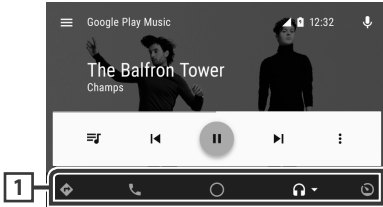

### 1 Application/information buttons

Starts the application or displays information.

### To exit the Android Auto screen

1 Press the  button.

## Using voice control

1 Press the  button for 1 second.

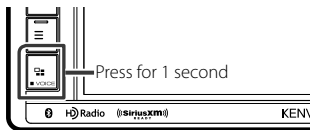

### To cancel

1 Press the  button.

## Switch to the Android Auto screen while listening to another source

1 Press the  button.

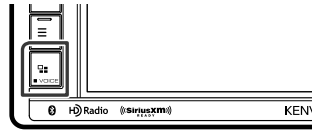

### NOTE

- If sound is output using Android Auto when the Android Auto screen is displayed, the source is switched to Android Auto.

## Pandora® Operation

You can listen to the Pandora® on this unit by controlling the application installed in the iPhone or Bluetooth device.

To enter Pandora source, touch **Pandora** icon in the source selection screen. (P.11)

### Preparation

- Install the latest version of the Pandora® application on your iPhone, Android or BlackBerry.
- iPhone:** Search for "Pandora" in the Apple App Store to find and install the most current version.
- Android:** Visit the Google play and search for Pandora to install.
- BlackBerry:** Visit www.pandora.com from the built in browser to download the Pandora application.
- iPhones are connected on either USB or Bluetooth.
- Android or BlackBerry devices are connected on Bluetooth.
- To connect a smartphone via Bluetooth, register it as the Bluetooth device and do the App (SPP) profile setting of the connection beforehand. See **Register from the Bluetooth device (P.54)** and **Connect the Bluetooth device (P.56)**.

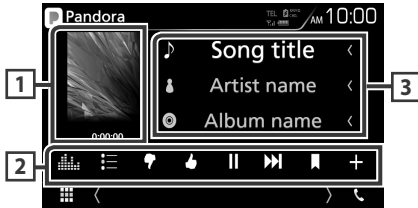

### 1 Artwork/ Playing time

- The picture data is displayed if available from current content.
- For confirmation of play time.

### 2 Function bar

- : Searches for a station. For details on searching, see **Station list screen (P.30)**.
- (Thumbs down) : Thumbs down to the current contents and skip to the next contents.
- (Thumbs up) : Registers the current contents as favorite content.
- : Plays or pauses the content of the current station.

- : Skips the current song. (Note this function is disabled when the Pandora skip limitation is exceeded.)
- (Bookmark Song) : Bookmarks a song in the current contents.
- : Creates a new station. See **Creates a new station (P.31)**.
- : Displays the Graphic Equalizer screen. (P.74)

### 3 Content information

Displays the information of the current content being played.

## Station list screen

You can perform the following functions from this screen.

### 1 Touch .

➤ Station List screen appears.

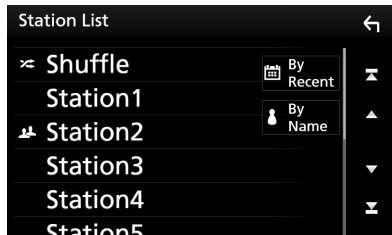

### ■ Selects the station

Touch the station name in the list.

### ■ Sort the list by registered date

Touch **By Recent**. The list is sorted to begin with the last registered station.

### ■ Sort the list in alphabetical order

Touch **By Name**. You can select the desired letter from the list which corresponds to the station name to help narrow the search.

### NOTE

- You can operate Pandora by using the remote control. However, only playing, pausing, and skipping are available.

**Creates a new station**

1 Touch **+** .

2 Touch desired item.

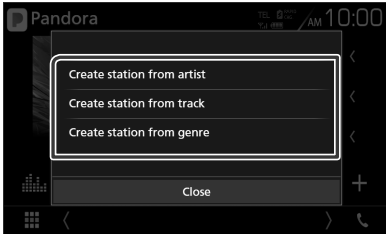

**Create station from artist**

Creates a new station based on an artist being played.

**Create station from track**

Creates a new station based on a song being played.

**Create station from genre**

Displays the genre list screen.

**Genre list screen**

1 Touch **Create station from genre** .

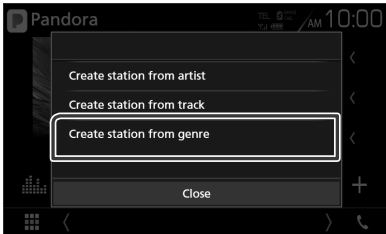

2 The selected genre is created as a new station.



**About Pandora®**

**iPhone or iPod touch**

- Install the latest version of the Pandora application on your iPhone or iPod touch. (Search for “Pandora” in the Apple App Store to find and install the most recent version.)

**Android™**

- Visit the Google play and search for Pandora to install.

**BlackBerry®**

- Visit [www.pandora.com](http://www.pandora.com) from the built in browser to download the Pandora application.
- Bluetooth must be built in and the following profiles must be supported.
  - SPP (Serial Port Profile)
  - A2DP (Advanced Audio Distribution Profile)

**NOTE**

- In the application on your device, log in and create an account with Pandora. (If you are not already a registered user, an account can also be created at [www.pandora.com](http://www.pandora.com).)
- Establish an Internet connection.
- Pandora is only available in certain countries. Please visit <http://www.pandora.com/legal> for more information.
- Because Pandora® is a third-party service, the specifications are subject to change without prior notice. Accordingly, compatibility may be impaired or some or all of the services may become unavailable.
- Some functions of Pandora® cannot be operated from this unit.
- For issues using the application, please contact Pandora® at [pandora-support@pandora.com](mailto:pandora-support@pandora.com).

## Spotify Operation

You can listen to the Spotify on this unit by controlling the application installed in the iPhone or Android.

To enter Spotify source, touch **Spotify** icon in the source selection screen. (P.11)

### Preparation

- Install the latest version of the Spotify application "Spotify" on your iPhone or Android.
- iPhone:** Search for "Spotify" in the Apple App Store to find and install the most current version.
- Android:** Search for "Spotify" in Google play to find and install the most current version.
- iPhones are connected on either USB or Bluetooth.
- Android devices are connected on Bluetooth.
- To connect a smartphone via Bluetooth, register it as the Bluetooth device and do the App (SPP) profile setting of the connection beforehand. See **Register from the Bluetooth device (P.54)** and **Connect the Bluetooth device (P.56)**.



### 1 Artwork/ Playing time

- The picture data is displayed if available from current content.
- For confirmation of play time.

### 2 Function bar

- : Displays the Menu screen
- : New radio station that relates to the artist of the currently playing song is selected and playback starts.
- , : Skips the current song.
- : Plays or pauses the content of the current station.
- : Saves currently playing song to My Music.
- : Displays the Graphic Equalizer screen. (P.74)

### 3 Content information

Displays the information of the current content being played.



- : Thumbs down to the current contents and skip to the next contents.
- : Registers the current contents as favorite content.
- : Repeats the current song.
- : Randomly plays all song in current playlist.

### Selecting a track

- 1 Touch .  
 > Menu screen appears.
- 2 Select the list type, then select a desired item.

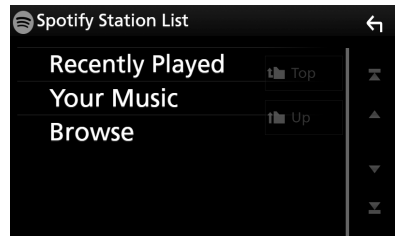

### Selects the category and station

Touch the category and station name in the list.

#### Top

Returns to the first hierarchy of the list.

#### Up

Returns to the previous list.



**About Spotify®****iPhone or iPod touch**

- Install the latest version of the Spotify application on your iPhone or iPod touch. (Search for “Spotify” in the Apple App Store to find and install the most recent version.)

**Android™**

- Visit Google play and search for “Spotify” to install.

**Note**

- Ensure you are logged in to your smartphone application. If you do not have an Spotify account, you can create one for free from your smartphone or at [www.spotify.com](http://www.spotify.com).
- Because Spotify is a third-party service, the specifications are subject to change without prior notice. Accordingly, compatibility may be impaired or some or all of the services may become unavailable.
- Some functions of Spotify cannot be operated from this unit.
- For issues using the application, contact Spotify at [www.spotify.com](http://www.spotify.com).
- Establish an Internet connection.

# HD Radio™ Tuner

## HD Radio Tuner Basic Operation

Most functions can be controlled from the source control screen.

To enter HD Radio source, touch **HD Radio** icon in the source selection screen. (P.11)

### NOTE

- Set the remote control mode switch to **AUD** mode before starting operation, see **Switch the operation mode (P.80)**.
- HD Radio broadcasting is for North American sales area only.
- The screen shot below is for tuner. It may be different from the one for HD Radio broadcasting.

Control screen



Preset list screen



### 1 Indicator display

While receiving an HD Radio station, it lights with orange when the audio is digital and lights with gray when it is analog. While receiving an analog station, it is off.

### 2 Information display

Displays the information of the current station: Frequency and Channel

Touching allows you to switch between Content A, Content B and Content C.

Content A: Station name, Song Title, Artist Name

Content B: Station Message, Radio Text

Content C: PTY Genre, Album Name

### 3 AUTO1 / AUTO2 / MANUAL

Switches the seek mode in the following sequence; **AUTO1**, **AUTO2**, **MANUAL**.

- **AUTO1**: Tunes in a station with good reception automatically.
- **AUTO2**: Tunes in stations in memory one after another.
- **MANUAL**: Switches to the next frequency manually.

### 4 Function bar

- : Tunes in a station. The method of frequency switching can be changed (see 3 in table).
- **CH** **CH** : Selects a channel.
- : Display the Channel List screen. See **Channel search (P.37)**.
- : Display a list of registered bookmarks. See **Bookmark list (P.39)**.
- : Displays the Graphic Equalizer screen. (P.74)

### 5 Preset key

Recalls the memorized station or channel.

- Touch on the right side of the screen to display the Preset list. Touch again to close the list.

### 6 Function panel

Touch on the left side of the screen to display the function panel. Touch again to close the panel. For details on the keys, see **Function panel (P.35)**.

### 7 Picture

The picture data or station Logo data is displayed if available from current content.

### 8 FM AM

Switches the band.

## 9 Preset list

Recalls the memorized station or channel.  
When touched for 2 seconds, stores the current receiving station or channel in memory.

## 10 Indicator Items

- **MC:** A multicast digital broadcast is being received.
- **ANALOG:** An analog broadcast is being received.
- **DIGITAL:** A digital broadcast is being received.
- **ST:** A stereo broadcast is being received.
- **EA:**
  - White: Emergency Alert is on.
  - No light: Emergency Alert is off.
  - Orange: Interrupting or in snooze/ignore state.

## Function panel

### 1 Touch on the left side of the screen.

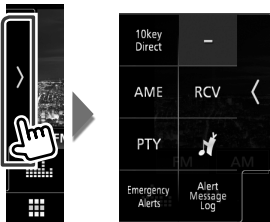

The functions of each key are as follows.

### 10key Direct

Display the direct station/ channel search screen.  
For details, see **Direct search (P.37)**.

### AME

Presets stations automatically. For details, see **Auto memory (P.36)**.

### RCV

Change the HD Radio reception mode. For details, see **Receive Mode (P.36)**.

### PTY (FM only)

Searches a program by setting program type. For details, see **Search by program type (P.38)**.



Stores the information about the song being received. See **Bookmark (P.38)**.

## Emergency Alerts

Turn on or off the alert message. See **Alert Message (P.40)**.

## Alert Message Log

Displays the alert message received. See **Alert Message (P.40)**.

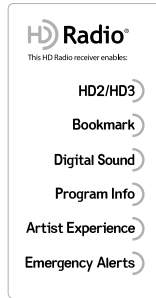

### HD2/HD3

- Adjacent to traditional main stations are HD2/HD3 Channels, providing new original programming on the FM dial

### Bookmark

- A music & product discovery feature that enables users to store information about content on the radio, and can deliver interactive information via QR codes

### Digital Sound

- Crystal clear, CD-like digital audio quality to consumers; eliminates background noise

### Program Info

- Provides song name, artist, station ID, and other relevant data to enrich the listening experience

### Artist Experience

- Visual images, such as album art of over-the-air broadcasts from HD Radio stations

### Emergency Alerts

- Delivers critical and life-saving messages to the public during emergency situations

## Receive Mode

You can set the radio broadcasts receive mode.

- 1 Touch on the left side of the screen.  
Touch **RCV**.

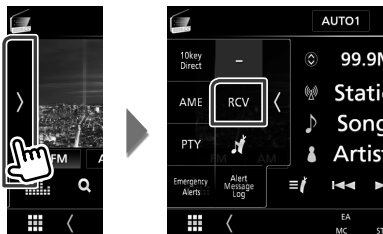

- 2 Select a receive mode.

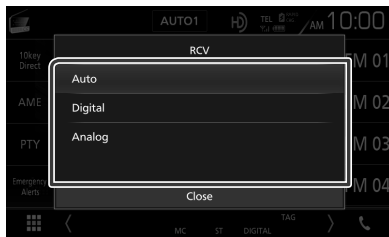

### ■ Auto

Switch between digital and analog audio automatically.

### ■ Digital

Select this to tune to digital audio only.

### ■ Analog

Select this to tune to analog audio only.

## Memory Operation

### ■ Auto memory

You can store stations with good reception in memory automatically.

- 1 Touch desired band key.

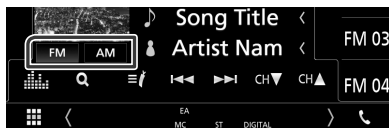

- 2 Touch on the left side of the screen.  
Touch **AME**.

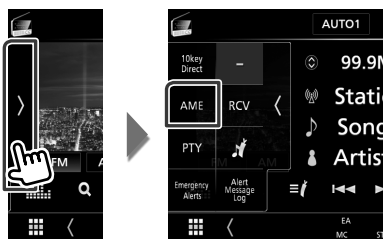

- 3 Touch Yes.

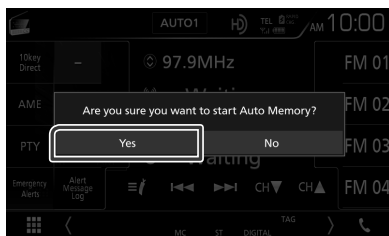

➤ Auto memory starts.

### ■ Manual memory

You can store the current receiving station or channel in memory.

- 1 Select a station or channel you wish to store in memory.
- 2 Touch **FM#** (#:1-15) or **AM#** (#:1-5) in which you want to store the station or channel for 2 seconds until a beep sounds.

## Selecting Operation

### Preset select

You can list and select memorized station or channel.

- 1 Touch on the right side of the screen. Select a station or channel from the list.

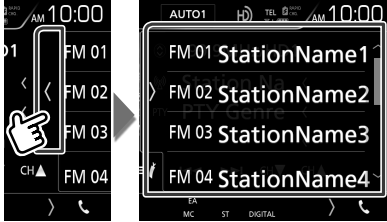

### Direct search

You can tune in by entering the desired frequency or channel number.

- 1 Touch on the left side of the screen. Touch **10key Direct**.

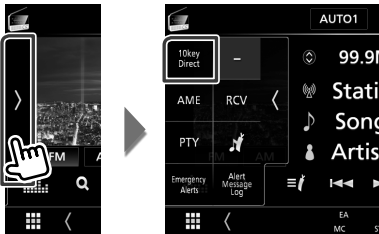

- 2 Select the search method.



- 3 Enter the frequency or channel number.
- 4 Touch **Enter**.

#### NOTE

- To clear the number you entered, touch **BS**.

### Channel search

You can specify the desired channel.

- 1 Touch **Q**.

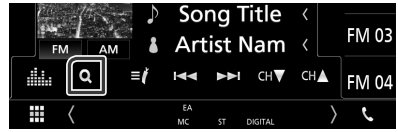

- 2 Select the desired content from the list.



#### NOTE

- Touch **Info Change** in the channel list. Select the sequence of the list (Song title, artist name, album name).

## Search by program type (FM only)

You can tune to a station with a specific program type when listening to FM.

- 1 Touch on the left side of the screen. Touch **PTY**.

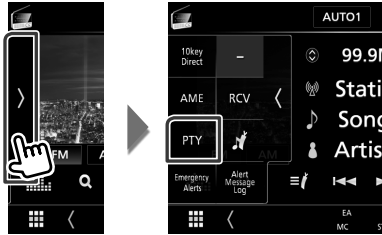

➤ TUNER PTY Mode screen appears.

- 2 Select a program type from the list.
- 3 Touch **Search**.

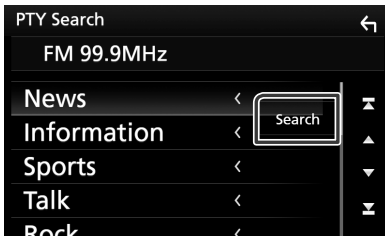

You can search a station of the selected program type.

## Bookmark

Stores tag information (title, artist, album, URL, and description) about the song you are listening to now.

Detailed information and QR codes can be displayed according to the stored tag information.

### Bookmark registration

- 1 Touch on the left side of the screen. Touch .

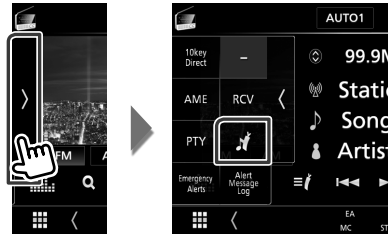

➤ Registers a bookmark.

#### NOTE

- Up to 100 bookmarks can be registered to this unit.

## **Bookmark list**

Displaying a list of registered bookmarks and detailed information and QR code of the song.

### 1 Touch .

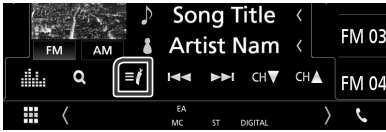

### 2 Select the desired bookmark from the list.

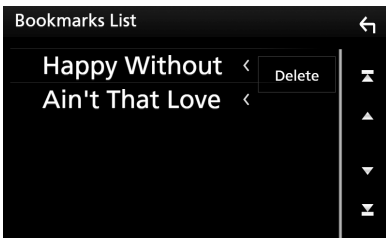

► The bookmark information appears.



### **Delete**

Deletes the bookmarks being displayed.

## **Bookmark delete**

Deleting a bookmark.

### 1 Touch **Delete**.



### 2 Select the bookmark to delete from the list.

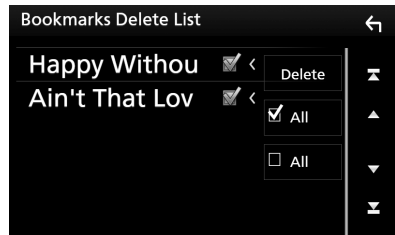

#### **All**

Select all bookmarks.

#### **All**

Erases all check marks.

### 3 Touch **Delete**.

► Confirmation message appears.

### 4 Touch **Yes**.

► Deletes all the selected bookmark(s).

## Alert Message

This function is to receive alert messages. First, you need to turn on the "Emergency Alerts". (P.35)

### When an Alert Message comes

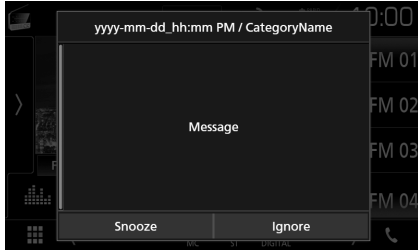

#### Snooze

The alert message is erased. Same alert message cannot be displayed for next 10 minutes.

#### Ignore

The alert message is erased. Same alert message cannot be displayed for next 12 hours.

### Display of the received Alert Message

You can read the received alert message afterward.

- 1 Touch on the left side of the screen. Touch **Alert Message Log**.

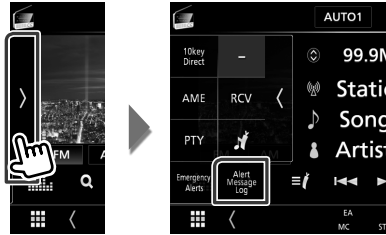

- 2 Select the desired Alert Message from the list.

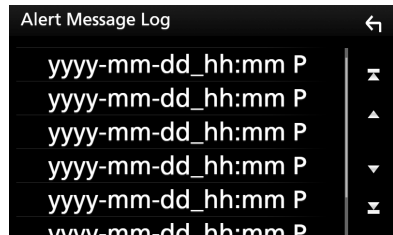

> The Alert Message appears.

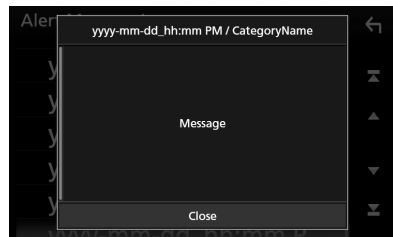

- 3 Touch **Close**.



# SiriusXM®

## SiriusXM® Basic Operation

Only SiriusXM® brings you more of what you love to listen to, all in one place. Get over 140 channels, including commercial-free music plus the best sports, news, talk, comedy and entertainment. Welcome to the world of satellite radio. A SiriusXM Vehicle Tuner and Subscription are required. For more information, visit [www.siriusxm.com](http://www.siriusxm.com).

To enter SiriusXM source, touch **SiriusXM** icon in the source selection screen. (P.11)

### Activating subscription

- Check your Radio ID.  
The SiriusXM Satellite Radio ID is required for activation and can be found by tuning to Channel 0 as well as on the label found on the SiriusXM Connect tuner and its packaging.  
The Radio ID does not include the letters I, O, S or F.
- Activate the SiriusXM Connect Vehicle Tuner using one of the two methods below:
  - For users in the U.S.A.  
Online: Visit [www.siriusxm.com/activatenow](http://www.siriusxm.com/activatenow)  
Phone: Call SiriusXM Listener Care at 1-866-635-2349
  - For users in Canada:  
Online: Visit [www.siriusxm.ca/activatexm](http://www.siriusxm.ca/activatexm)  
Phone: Call XM customer Care at 1-877-438-9677

### NOTE

- Set the remote control mode switch to **AUD** mode before starting operation, see **Switch the operation mode (P.80)**.
- To use SiriusXM® Satellite Radio, the optional accessory is necessary.

### Control screen



### Preset list screen

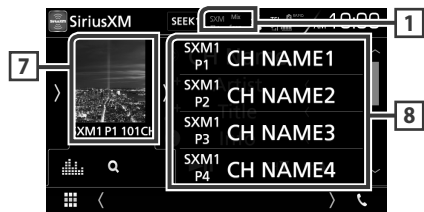

### 1 Indicator display

Displays the “Mix” (TuneMix™), “Scan” (TuneScan™), (Traffic&Weather), (SportsFlash™) indicator and the received signal strength of the SiriusXM tuner.

### 2 Information display

Displays the information of the current channel: Channel Name

Touching allows you to switch between Content A and Content B.

Content A: Artist Name, Song Title, Content Info  
Content B: Category Name, Channel Description, Similar Channels

: Touch for 2 seconds to registers the artist of the current song as a Content Alert.

: Touch for 2 seconds to registers the current song as a Content Alert.

For details, see **Content Alerts (P.47)**.

### 3 SEEK

Switches the seek mode in the following sequence; **SEEK1**, **SEEK2**.

**SEEK1**: Tunes channels one after the other.

**SEEK2**: Selects channels in preset (memory) one after the other.

#### 4 Function bar

- **Q** : Display the Category search screen. For details on search operation, see **Category/Channel search (P.44)**.
- **▶||** : Plays or pauses. See **Replay (P.45)**.
- **CH▼ CH▲** : Selects a channel.
- **📊** : Displays the Graphic Equalizer screen. (P.74)

#### 5 Preset key

Recalls the memorized channel.

Touch on the right side of the screen to display the Preset list. Touch again to close the list.

#### 6 Function panel

Touch on the left side of the screen to display the function panel. Touch again to close the panel. For details on the keys, see **Function panel (P.42)**.

#### 7 Information display

Displays the following information.

**SXM#**: Band display

**P#**: Preset number

**#CH**: Channel display

**Logo**: Display album artwork for most SiriusXM music channels

#### 8 Preset list

Recalls the memorized channel.

When touched for 2 seconds, stores the current receiving channel in memory.

### Function panel

#### 1 Touch on the left side of the screen.



The functions of each key are as follows.

#### Direct Channel

Touch and enter the desired number. For details, see **Direct search (P.44)**.

#### SETUP

Touch to display the SiriusXM SETUP screen. For details, see **SiriusXM Setup (P.48)**.

#### Band

Switches the band. (SXM1/ SXM2/ SXM3/ SXM4)

#### Replay / Live

Turns the replay mode on or off. See **Replay (P.45)**.

#### Traffic & Weather

##### For SXV300 \*1

Traffic & Weather Now™ allows you to access the latest report whenever you want to hear it. Select your city at the set up menu **Select a City for Traffic & Weather (P.52)** and press the **Traffic & Weather** button to check the latest report. It will start from the beginning.

- (White) : Played already.
- (Green) : New information arrived.
- (Purple) : Playing.
- (Gray) : No information.

##### For SXV200 or SXV100 \*2

Turns the Traffic & Weather Jump function on or off.

- (White) : Function on.
- (Purple) : Playing.
- (Gray) : Function off.

**TuneScan** \*3

Hear a few seconds of the songs from each of the SmartFavorite music channels on the current preset band. See **TuneScan™ (P.46)**.

**TuneMix** \*4

When you turn it ON, the preset channels on P1-P6 are shuffled to provide a playback which is a blend of songs from your favorite channels. See **TuneMix™ (P.45)**.

**SportsFlash** \*4

Displays during SportFlash™. To cancel the SportFlash interruption and return to the previous channel, touch it. See **SportsFlash™ (P.47)** and **SportsFlash™ setup (P.51)**.

\*1 Compatible with SXV300 or later tuner models. It may take a few minutes after power on to get the first full report for your city. Traffic channels are not available in Canada.

\*2 When SXV200 or SXV100 is connected with this unit.

\*3 Compatible with SXV200 or later tuner models.

\*4 Compatible with SXV300 or later tuner models.

**Storing Channels in Preset Memory**

You can store the current channel in memory.

- 1 Tune to a channel you wish to store in memory.
- 2 Touch on the right side of the screen.

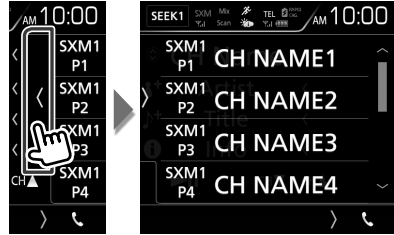

- 3 Touch and hold for 2 seconds (until you hear a beep) the preset number **SXM(1-4) P(1-6)** in which you want to store the channel.

**Preset select**

You can list and select memorized station or channel.

**To select from the preset list**

- 1 Touch on the right side of the screen. Select a channel from the list.

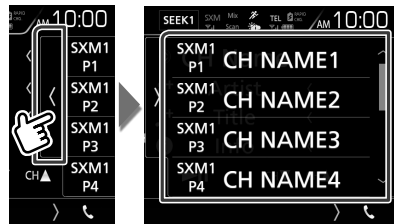

## Direct search

You can tune to a channel directly.

- 1 Touch on the left side of the screen. Touch **Direct Channel**.

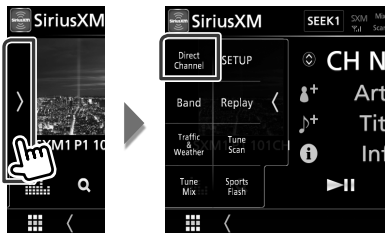

- 2 Enter the channel number and touch **Enter**.



### NOTE

- To clear the number you entered, touch **BS**.

## Category/Channel search

You can specify the desired category and select a channel.

- 1 Touch **Q**.



- 2 Select a category.



► Channel list appears.

- 3 Select the desired content from the list.

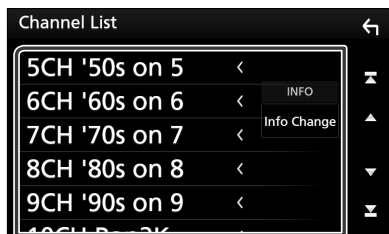

### NOTE

- All the channels in the selected category appear.
- Touching **All-Channels** displays all the channels.
- Touch **Info Change** in the channel list. Select the sequence of list as follows; Channel name, artist name, song title, category name, content info
- Categories which have the prefix "Featured -" are Featured Favorites.
- Featured Favorites are groups of channels that are created by the SiriusXM Programming department allowing you to discover new channels. Featured Favorite channels are dynamic and can change often, allowing you to discover new channels.

## Replay

You can replay the last 60 minutes of the current channel.

- 1 Touch **▶||** or **Replay** on the function panel.



Press to skip to the previous/next track.  
Press and hold to rewind or fast forward.



Plays or pauses.



Tune in a channel.



Display recorded capacity and playback position.

▶, ▶▶, etc.: Current play mode indicator



Display a list of recorded data on a program basis.

- 2 Touch **Q** to display an Instant Replay list.

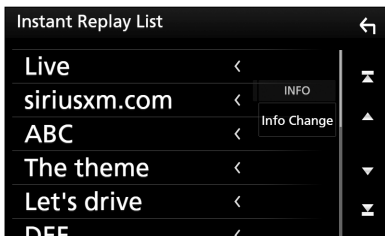

### ■ Instant Replay List

Touching this plays back the displayed program.

### ■ Info Change

Touch **Info Change**. Select the sequence of the list as follows;

Artist name, Song title, Category name,  
Content info, and Channel name

## To return to live music/content

- 1 Touch on the left side of the screen.
- 2 Touch **Live**.

## TuneMix™

TuneMix™ plays a unique blend of songs from your Preset music channels from the current SiriusXM Preset Band, allowing you to build a custom channel from as few as two to as many as 6 music channels. You can even skip songs you don't want to hear.

Touch on the left side of the screen.

- 1 Touch on the left side of the screen.  
Touch **TuneMix** to set ON or OFF.

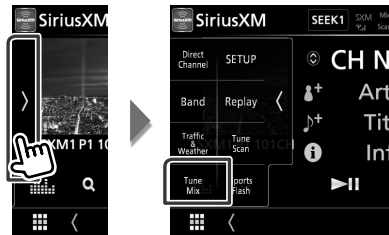

### NOTE

- Compatible with SXV300 or later tuner models.

## SmartFavorites, TuneStart™

Preset channels 1 through 6 of the current band are SmartFavorites channels.

The SiriusXM Vehicle Tuner automatically buffers the broadcast audio content of the SmartFavorites channels in the background.

You can rewind and replay up to 30 minutes of any of the missed news, talk, sports or music content when you tune to a SmartFavorites channel. (see **Replay (P.45)**)

When tuning from a SmartFavorites channel, songs will play from the beginning of each track (TuneStart™). You can enable/disable TuneStart. (see **TuneStart™ (P.52)**)

### NOTE

- Compatible with SXV200 or later tuner models.

## TuneScan™

TuneScan™ is a feature that plays samples from the starts of multiple buffered songs from each of the SmartFavorites channels that predominantly play music selections.

You have easy access to a large sampling of music content and can enjoy hearing a full song when stopping the scan on a song of interest.

### 1 Touch on the left side of the screen.

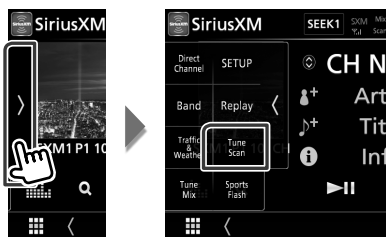

### 2 Touch **TuneScan** to begin scanning your SmartFavorites channels.

You will hear a few seconds of the songs from each of the SmartFavorite channels.

### 3 Touch **TuneScan** again while your favorite song is being played to start listening to that song.



➤ Scan finishes and continues playing the song.

#### NOTE

- To cancel TuneScan™, Touch on the left side of the screen. Touch **TuneScan**.
- Touch and hold **TuneScan** to cancel TuneScan, the channel before starting TuneScan will be played.
- Compatible with SXV200 or later tuner models.

## Traffic & Weather Now™

Traffic & Weather Now™ allows you to access the latest report whenever you want to hear it. Select your city at the set up menu **Select a City for Traffic & Weather (P.52)**.



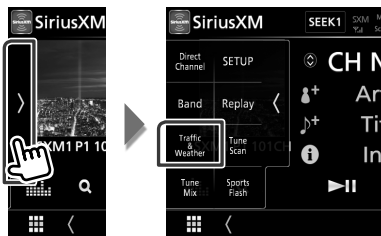

### 1 Touch on the left side of the screen.



### 2 Touch **Traffic & Weather**.

The report starts from the beginning. To stop and return to the previous channel, touch it again.

#### Indicator display

-  (White) : Played already.
-  (Green) : New information arrived.
-  (Purple) : Playing.
-  (Gray) : No information.

#### NOTE

- Compatible with SXV300 or later tuner models.

## Content Alerts

When a broadcast program related to the registered artist, song or team starts, a message appears to allow you to switch the current channel to the relevant channel.

### 1 When the broadcast of the registered content starts, an Alert screen appears.

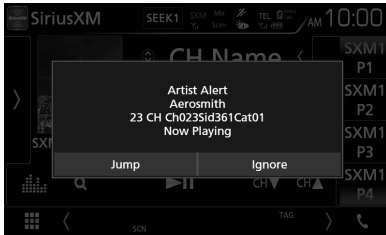

#### ■ Jump

Touch to display the Alert Content List screen.

#### ■ Ignore

Touch to cancel the Content Alerts.

### 2 Select a content from the list.

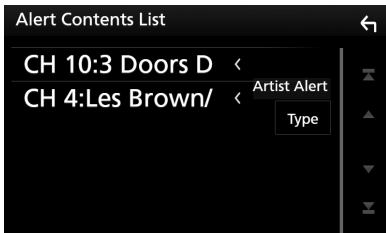

#### NOTE

- Touch **Info Change**. Select the sequence of the channel list as follows; Artist Alert, Song Alert, GameAlert™
- To learn how to register artists and songs the Team alert function, see 2. Information display of **SiriusXM® Basic Operation (P.41)**.
- To learn how to set up the Content Alerts function, see **Content Alerts setup (P.50)**.

## SportsFlash™

SportsFlash™ will notify you when a big play happens during a game with one of your favorite sports teams. Choose to tune in and hear the play unfold like it was live. Continue listening to the game, or you can return to your previous channel.

### 1 When a big play happens during one of the games, an Alert screen appears.

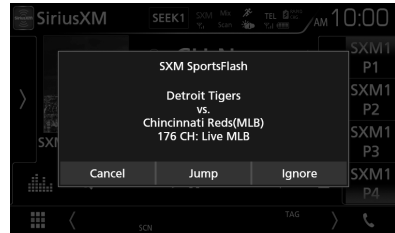

#### ■ Jump

Touch to tune to that channel and play back the big play.

#### ■ Ignore

Touch to cancel this specific Sports Flash Alert. Touching **Ignore** will ignore this specific alert but will allow future alerts for this game.

#### ■ Cancel

Touch to cancel the SportsFlash alert. No alerts from this game will be displayed afterward.

#### NOTE

- Compatible with SXV300 or later tuner models.
- To learn how to set up the SportsFlash alert function, see **SportsFlash™ setup (P.51)**.

## SiriusXM Setup

- 1 Touch on the left side of the screen. Touch **SETUP**.

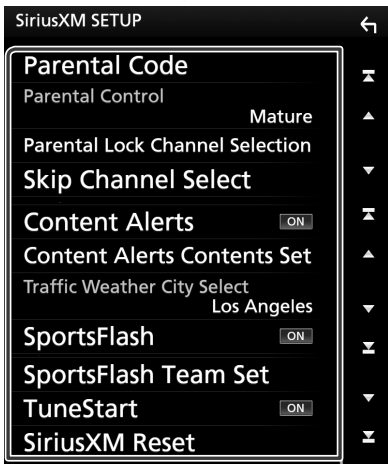
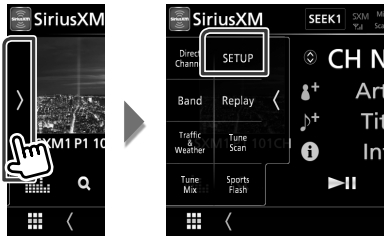

- SiriusXM SETUP screen appears. See the following section for each setting.
  - Set up the parental code (**P.48**)
  - Set up the Parental Control (**P.49**)
  - Set up the skip channel select (**P.50**)
  - Set up the Content Alerts (**P.50**)
  - Set up the team for SportsFlash™ (**P.51**)
  - Select the city for Traffic & Weather Jump or Traffic & Weather Now™ (**P.52**)
  - Set up the TuneStart™ (**P.52**)
  - Reset to the default settings (**P.52**)

## Parental code

You can set a SiriusXM parental code for Parental Control.

- 1 Touch **Parental Code** in the SiriusXM **SETUP** screen.

➤ Parental Pass Check screen appears.

### NOTE

- The code number is set to "0000" as default.

- 2 Enter the current code number and touch **Enter**.

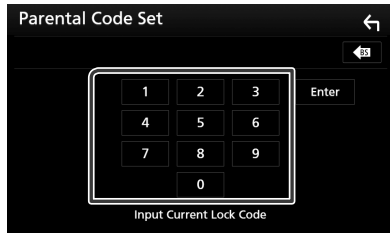

➤ Parental Pass 1st entering screen appears.

- 3 Enter the new code number and touch **Enter**.

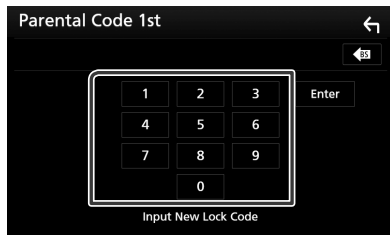

➤ Parental Pass 2nd entering screen appears.

- 4 Enter the same code number as you input in step 2 and touch **Enter**.

➤ The code number is confirmed and SiriusXM parental code is now set.



## Parental Control

Parental Control is a feature that provides the user with the ability to prevent unauthorized access to mature content and user selected channels.

- 1 Touch **Parental Control** in the SiriusXM SETUP screen.
- 2 Touch **Mature, User or OFF**.
  - **OFF**  
Deactivates the parental mature and user locks.
  - **Mature**  
Locks channels classified as "mature" only.
  - **User**  
Locks only the selected channels.
- 3 Enter the parental code you originally input in **Parental code (P.48)** and touch **Enter**.

### When selecting User

This allows you to limit access to any SiriusXM channel (Parental Lock Channel).

- 1 Touch **Parental Lock Channel Selection** in the SiriusXM SETUP screen.
  - Parental Pass Check screen appears.

#### NOTE

- You need to set up a **Parental code (P.48)** beforehand.

- 2 Enter the parental code you originally input in **Parental code (P.48)** and touch **Enter**.
  - Parental Lock Category Select screen appears.
- 3 Touch the desired category from the list.

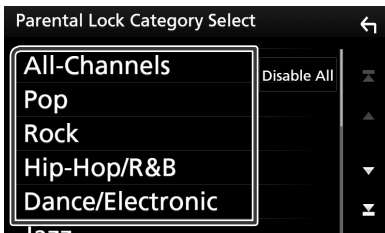

- Displays all the channels in the selected category.

#### NOTE

- Touch **All-Channels** to display all the channels.
- To delete the parental lock channel setting, touch **Disable All** and then touch **YES** on the confirmation screen.

- 4 Touch each channel on the list and set to **ON** or **OFF**.

On: If you wish to set the lock.

Off: If you wish to unlock the channel.

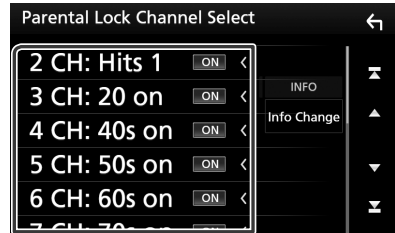

#### NOTE

- Touch **Info Change**. Select the sequence of the channel list as follows;
- Channel name, Artist name, Song title, Category name, Content information.

## Skip channel select

You can set the undesired channels to skip.

- 1 Touch **Skip Channel Select**.
  - Skip Category Select screen appears.
- 2 Touch the desired category from the list.



- Displays all the channels in the selected category.

- 3 Touch each channel on the list and set to ON or OFF.

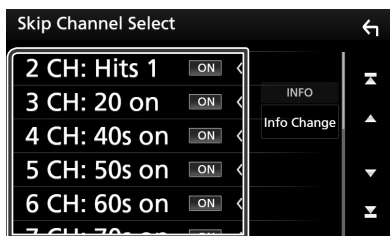

### NOTE

- To delete the skip channel setting, touch **Disable All** and then touch **YES** on the confirmation screen.
- Touch **Info Change**. Select the sequence of the channel list as follows; Channel name, Artist name, Song title, Category name, Content information.

## Content Alerts setup

### Activating content alert

- 1 Touch **Content Alerts** in the SiriusXM SETUP screen.
  - The Content Alerts is turned on or off. Default is "ON".

### Selecting the content for the content alert

- 1 Touch **Content Alerts Contents Set** in the SiriusXM SETUP screen.
  - Artist list screen appears.
- 2 Select the content you want to set up.



### NOTE

- To set all the content Alerts off, touch **Disable All** and then touch **YES** on the confirmation screen.

- 3 Touch each content list and set ON or OFF.

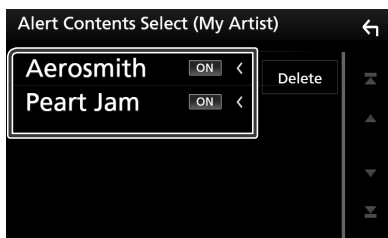

### NOTE

- You can select "ON" up to 60 items of Artist and Song.

### To delete the Artist and Song

- 1 Touch **Delete**.

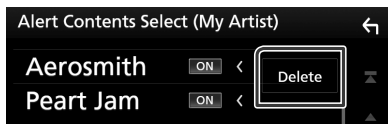

## 2 Touch each content list.



## 3 Touch **Delete** and then touch **YES** on the confirmation screen.

### To select a Team

Get alerted when your favorite sports team is playing on another SiriusXM channel with GameAlert™

## 1 Touch **My Games**.



## 2 Touch the desired league from the list.

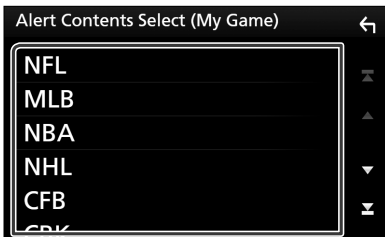

## 3 Touch each team list and set ON or OFF.

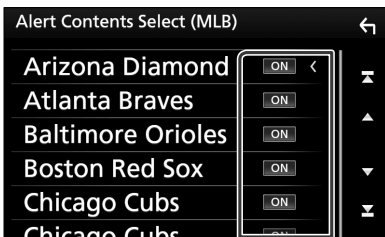

### NOTE

- You can select "ON" up to 30 items of Team.

## SportsFlash™ setup

### Activating SportsFlash

## 1 Touch **SportsFlash** in the SiriusXM SETUP screen.

- The SportsFlash is turned on or off. Default is "ON".

### Selecting the team for SportsFlash

## 1 Touch **SportsFlash Team Set** in the SiriusXM SETUP screen.

- Team Set screen appears.

## 2 Touch **Edit**.

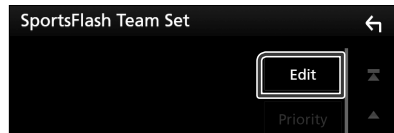

## 3 Touch the desired league from the list.



## 4 Touch each team list and set ON or OFF.

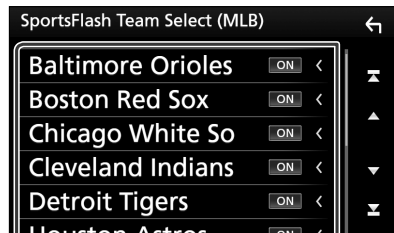

## 5 Touch twice.



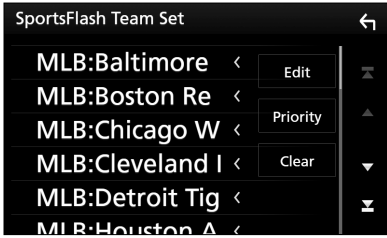

**Edit**

Sets and removes teams.

**Priority**

Sets the priority of a team to be posted.

**Clear**

Removes all teams that have been set. Touch **Clear**. When the confirmation screen appears, touch **YES**.

**NOTE**

- SportsFlash™ is available on SXV300 or later tuner models.
- Up to 50 teams can be added.

**Set the SportsFlash™ Team Priority**

**1 Touch Priority.**



**2 Set the priority of a team.**

Each time you touch Team, the priority is set and reset.



**3 Touch Done.**

**NOTE**

- Priority can be set on up to 5 teams.

**Select a City for Traffic & Weather**

You can select a city for which you wish to receive SiriusXM Traffic & Weather broadcasts and hear them from the beginning.

**1 Touch Traffic & Weather City Select in the SiriusXM SETUP screen.**

**2 Touch ◀ and ▶ to select a city.**

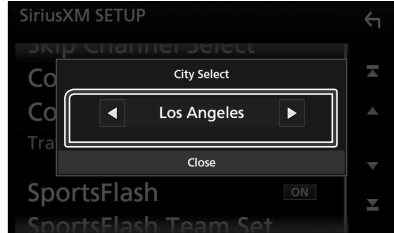

**TuneStart™**

**1 Touch Tune Start in the SiriusXM SETUP screen.**

The TuneStart is turned on or off. Default is "ON".

**Reset**

**1 Touch SiriusXM Reset in the SiriusXM SETUP screen.**

► Confirmation screen appears.

**2 Touch YES.**

► All SiriusXM settings return to default.

# Bluetooth Control

Using the Bluetooth function, various functions can be used: listening to the audio file, making/receiving a call.

## Information for using Bluetooth® devices



Bluetooth is a short-range wireless radio communication technology for mobile devices such as mobile phones, portable PCs, and other devices.

Bluetooth devices can be connected without cables and communicate with each other.

### NOTE

- While driving, do not perform complicated operations such as dialing numbers, using the phone book, etc. When you perform these operations, stop your car in a safe place.
- Some Bluetooth devices may not connect to this unit depending on the Bluetooth version of the device.
- This unit may not work for some Bluetooth devices.
- Connecting conditions may vary depending on your environment.
- For some Bluetooth devices, the device is disconnected when the unit is turned off.

## About the cell-phone and Bluetooth audio player

This unit conforms to the following Bluetooth specifications:

### Version

Bluetooth Ver. 3.0

### Profile

#### Cell-phone:

HFP (V1.6) (Hands Free Profile)

SPP (Serial Port Profile)

PBAP (Phonebook Access Profile)

### Audio player:

A2DP (Advanced Audio Distribution Profile)

AVRCP (V1.5) (Audio/Video Remote Control Profile)

### Sound codec

SBC, AAC

### NOTE

- For the cell-phones verified for compatibility, access the following URL:  
**<http://www.kenwood.com/cs/ce/bt/>**
- The units supporting the Bluetooth function have been certified for conformity with the Bluetooth Standard following the procedure prescribed by Bluetooth SIG.
- However, it may be impossible for such units to communicate with your cell-phone depending on its type.

## Register from the Bluetooth device

It is necessary to register the Bluetooth audio player or cell-phone to this unit before using the Bluetooth function.

You can register up to 10 Bluetooth devices.

### NOTE

- Up to 10 Bluetooth devices can be registered. If an attempt is made to register the 11th Bluetooth device, the Bluetooth device connected on the earliest date will be deleted to register the 11th one.
- This unit is compatible with the Apple Easy Pairing function. When an iPod touch or iPhone is connected to this unit, an authentication dialog appears. Performing operation for authentication on this unit or iOS smartphone registers the smartphone as a Bluetooth device.

Follow the step 1, 2 and 3 for registration.

### Step 1: Registration from the Bluetooth device

- 1 Search the unit (“DDX\*\*\*\*”) from your smartphone/cell-phone.
- 2 Input the PIN code in your smartphone/cell-phone.  
PIN code is set to “0000” as the default.

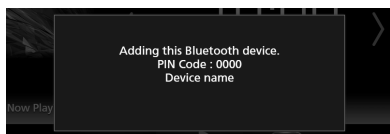

### ● SSP (Secure Simple Pairing of Bluetooth 2.1 or later)

- 1 Search the unit (“DDX\*\*\*\*”) from your smartphone/cell-phone.
- 2 Confirm the request both on the smartphone/cell-phone and the unit.

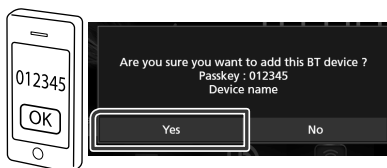

### Step 2: Connection settings

- When the HFP profile is supported, Hands Free 1 or 2 is automatically selected for connection, proceeding to the next step.
  - When the A2DP or SPP profile is supported, the cell-phone or audio player is automatically connected, proceeding to the next step.
- If cell-phones and/or audio players have already been connected, a selection screen appears.

- 1 Select the hands-free number to connect.  
A name of a smartphone is displayed when it has hands-free connection with the unit.



- 2 Select if you want to use the audio player app in your smartphone over A2DP, and the other apps in your smartphone over SPP.

This message appears if the device supports BT audio (A2DP) or smartphone link (SPP).

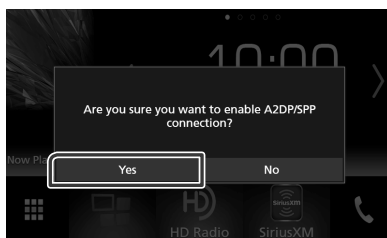

### Step 3: Phonebook transfer

#### 1 Select if you want to transfer your phonebook data.

This message appears if the device supports PBAP.

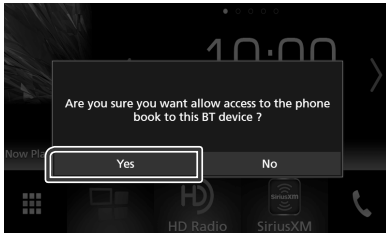

The phonebook data transmission starts. Some smartphones may request permission to access the data. The data transmission will start with your permission.



When the data transmission and connection have completed, the Bluetooth connection icon appears on the screen.

## Bluetooth Setup

#### 1 Press the button.

➤ Popup menu appears.

#### 2 Touch **SETUP**.



➤ SETUP Menu screen appears.

#### 3 Touch **Bluetooth**.

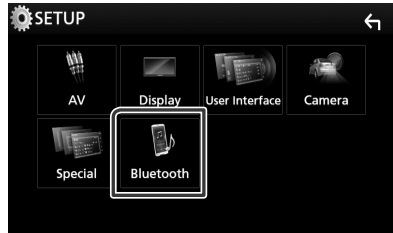

➤ Bluetooth SETUP screen appears.

See the following section for each setting.

- Connect the Bluetooth device (**P.56**)
- Change the PIN code (**P.57**)
- Change the device name (**P.57**)

## Connect the Bluetooth device

1 Touch **Select Device** in the Bluetooth SETUP screen.

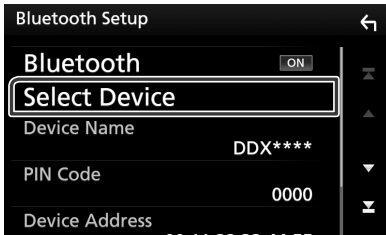

2 Touch the device name you want to connect.

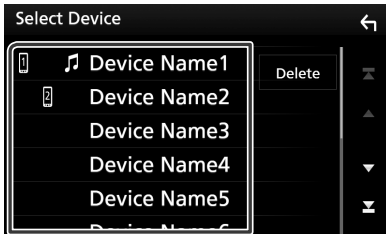

➤ Profile select screen appears.

### NOTE

- If the icon is lighted, it means that the unit will use that device.

3 Set each profile as follows.

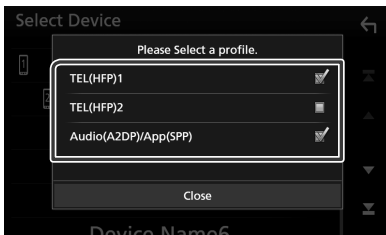

#### ■ TEL (HFP) 1, TEL (HFP) 2

The device is connected with the unit as hands-free phone 1 or 2.

#### ■ Audio (A2DP)/App (SPP)

Set to interwork with an application installed in a smartphone or to use as an audio player.

4 Touch **Close**.

## To delete the registered Bluetooth device

1 Touch **Delete**.

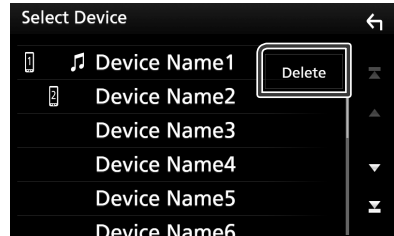

2 Touch the device name to check.

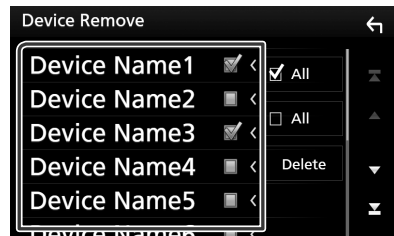

#### ■ All

Select all Bluetooth device.

#### ■ All

Erases all check marks.

3 Touch **Delete**.

➤ Confirmation message appears.

4 Touch **Yes**.



## Change the PIN code

- 1 Touch **PIN Code** in the Bluetooth SETUP screen.
  - PIN Code Set screen appears.
- 2 Input the PIN code.

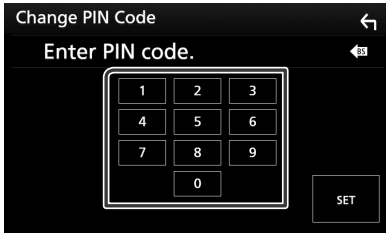

- 3 Touch **SET**.

## Change the device name

- 1 Touch **Device Name** in the Bluetooth SETUP screen.
  - Change Device Name screen appears.
- 2 Input the device name.



- 3 Touch **Enter**.

## Playing Bluetooth Audio Device

Most function can be controlled from the source control screen.

To enter Bluetooth source, touch **Bluetooth** icon in the source selection screen. (P.11)

## Bluetooth basic operation

### Control screen

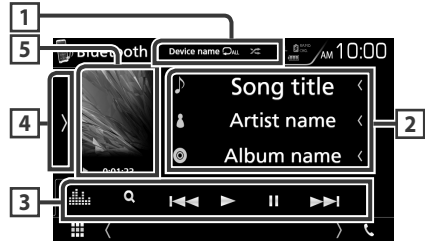

### 1 Device name/ [Repeat] / [Shuffle]

- Connected device name.
- [Repeat]: Repeats the current track/folder. Each time you touch the key, repeat mode switches in the following sequence; File repeat ([Repeat]), Folder repeat ([Repeat]), All songs repeat ([Repeat]), Repeat off ([Repeat]).
- [Shuffle]: Randomly plays all tracks in current folder. Each time you touch the key, random mode switches in the following sequence; Folder random ([Shuffle]), All random ([Shuffle]), Random off ([Shuffle]).

### 2 Information display \*

Displays the name of the track information.

### 3 Function bar \*

- [Search]: Searches file. See **File search (P.58)**.
- [Previous/Next]: Searches the previous/next content. Touch and hold to fast forward or fast backward.
- [Play]: Plays.
- [Pause]: Pauses.
- [Equalizer]: Displays the Graphic Equalizer screen. (P.74)

**4 Function panel**

Touch on the left side of the screen to display the function panel. Touch again to close the panel.

- **BT DEVICE CHANGE** : Selects the device to connect via Bluetooth audio (A2DP) or APP (SPP). See **Connect the Bluetooth audio (P.58)**.

**5 Play mode indicator/ Playing time**

▶, II: Current play mode indicator

The meanings of each icon are as follows;

- ▶ (play), ▶▶ (fast forward), ◀◀ (fast backward), II (pause), ■ (stop).

\*These items appear only when the audio player which supports AVRCP profile is connected.

**NOTE**

- If the operation keys do not appear, operate from the player.
- Depending on your cell-phone or audio player, audio may be heard and controlled but text information may not appear.
- If the volume is too low, raise it on your cell-phone or audio player.

**Connect the Bluetooth audio**

Selects the device to connect via Bluetooth audio (A2DP) or APP (SPP).

- 1 Touch on the left side of the screen. Touch **BT DEVICE CHANGE**.

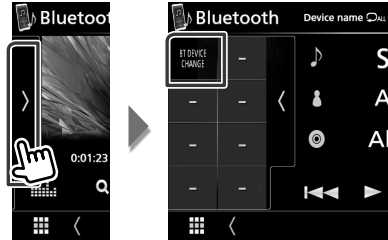

- 2 Touch the device name you want to connect.

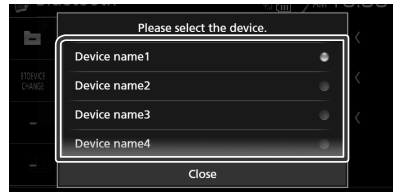

- 3 Touch **Close**.

**File search**

- 1 Touch **Q**.
- 2 Touch the desired file or folder.



When you touch a folder its contents are displayed.

- 3 Touch desired item from the content list.  
▶ Playback starts.

**NOTE**

- For operations in the list screen, see **List screen (P.14)**.

## Using Hands-Free Unit

You can use telephone function by connecting the Bluetooth telephone to this unit.

### NOTE

- While Apple CarPlay or Android Auto is being connected, Bluetooth Hands-Free function and two Bluetooth devices connections cannot be used. Only Apple CarPlay or Android Auto Hands-Free function can be used.

## Make a call

### 1 Touch .

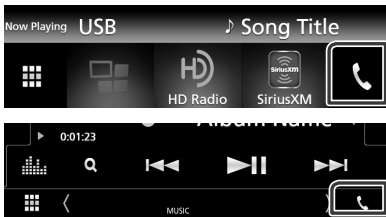





► Hands Free screen appears.

### NOTE

- If your mobile phone supports PBAP, you can display the phone book and call lists on the touch panel screen when the mobile phone is connected.
  - Phone book: up to 1000 entries
  - Up to 50 entries including dialed calls, received calls, and missed calls



### 2 Select a dialing method.



- : Call using call records
- : Call using the phonebook
- : Call using the preset number
- : Call by entering a phone number
- : Voice Recognition (P.60)

### ● Select the cell-phone to use

When you connect two cell-phones

- 1) Touch   to select the phone you want to use.

### ● Bluetooth SETUP

- 1) Touch .  
Bluetooth SETUP screen appears.

### NOTE

- The status icons such as battery and antenna displayed may differ from those displayed on the cell-phone.
- Setting the cell-phone in the private mode can disable the hands-free function.

## Call using call records

### 1 Touch .

### 2 Select the phone number from the list.



## Call by entering a phone number

### 1 Touch .

### 2 Enter a phone number with number keys.

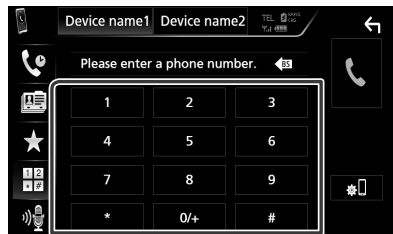

### 3 Touch .



## Bluetooth Control

### Call using the preset number

- 1 Touch .
- 2 Touch the Name or phone number.



### Call using the phonebook

- 1 Touch .
- 2 Touch .
- 3 Select the initial.



- Characters with no corresponding name will not appear.
- A first character with an accent character such as "ü" can be searched for with a non-accent character "u". A character with an accent character in a sentence cannot be searched.

- 4 Select the person you want to call from the list.

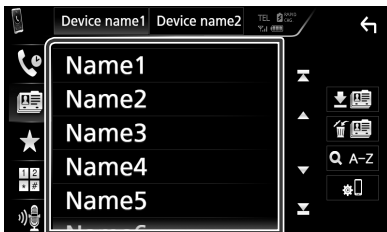

- 5 Select the phone number from the list.

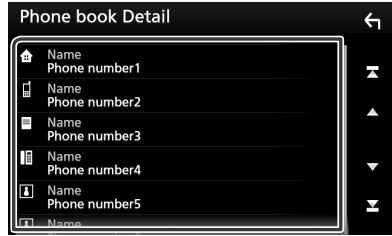

#### NOTE

- You can set the list to arrange in the order of last name or first name. For details, see **Hands-Free Setup (P.63)**.

### Voice Recognition

You can access the voice recognition function of the cell-phone connected to this unit. You can search the cell-phone phonebook by voice. (The functionality depends on the cell-phone.)

- 1 Press the  button for 1 second.

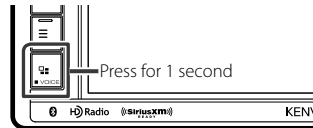



➤ Voice Recognition screen appears.

- 2 Start speaking.

#### NOTE

- You can use voice recognition function by touching  on the Hands Free screen.

## Receive a call

- 1 Touch  to answer a phone call or  to reject an incoming call.



### NOTE

- While monitoring the view camera, this screen does not appear even if a call comes in.

### To end call

- 1 While talking, touch .

## Operations during a call



### ● Adjust the volume of your voice

- 1) Touch **Speech Quality**.
- 2) Touch ◀ or ▶ of **Microphone Level**.



### ● Adjust the receiver volume

Press the ▼ or ▲ button.





### ● Mute your voice

Touch  to mute or not to mute your voice.

### ● Output the dial tone



Touch **DTMF** to display the tone input screen. You can send tones by touching desired keys on the screen.

### ● Switching the speaking voice output

Touching  /  each time switches the speaking voice output between cell-phone and speaker.

### ● Call-waiting

When you receive a call while talking on another call, you can answer the newly received call by touching . The current call is on hold.

Each time you touch , the caller will change. When you touch , the current call will end and switch to the call in hold.

### ● To close the Hands-Free popup screen

Touching [X] to close the Hands-Free popup screen. To display it again, touch .

## Bluetooth Control

### Phone number preset

You can register frequently used phone numbers to this unit.

1 Touch .

2 Touch **Edit**.



3 Select where to preset.

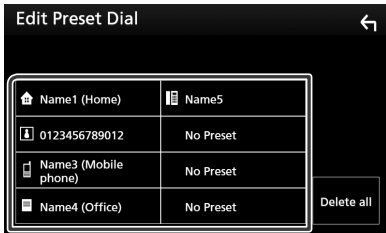

4 Select how to preset.

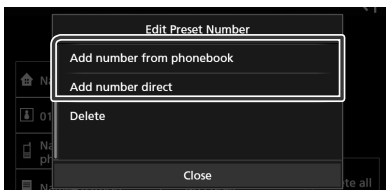

- **Add number from phonebook:**

Select the number to preset by referring to "Call using the phonebook". See **Call using the phonebook (P.60)**.

- **Add number direct:**

Enter the telephone number directly and touch **SET**. See **Call by entering a phone number (P.59)**.

#### NOTE

- To delete the preset number, touch **Delete** and then touch **OK** on the confirmation screen.

### Phonebook transfer

You can transfer the phonebook in your Bluetooth smartphone via PBAP.

1 Touch .

2 Touch .



➤ The phonebook data transmission starts.

### Phonebook deletion

1 Touch .

2 Touch the name to check.

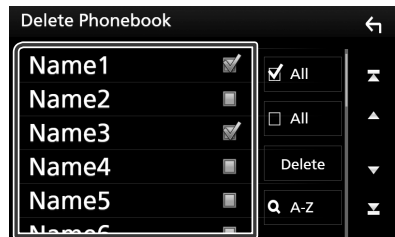

- **All**

Checks all boxes.

- **All**

Erases all check marks.

3 Touch **Delete**.

➤ Confirmation message appears.

4 Touch **OK**.

## Hands-Free Setup

You can perform various setup about handsfree function.

### 1 Press the button.

➤ Popup menu appears.

### 2 Touch **SETUP**.



➤ SETUP Menu screen appears.

### 3 Touch **Bluetooth**.

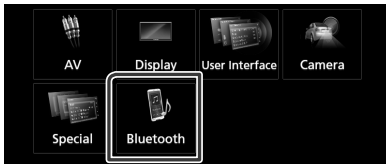

➤ Bluetooth SETUP screen appears.

### 4 Touch **TEL SETUP**.

➤ TEL SETUP screen appears.

### 5 Set each item as follows.



#### ■ Bluetooth HF/Audio

Select the speakers to output the sound from cell-phone (such as phone call voice and ringing tone) and Bluetooth audio player.

**Front:** Outputs from the front speakers.

**All (Default):** Outputs from all speakers.

#### ■ Auto Response\*

Sets an automatic response time to pick-up an incoming call.

**OFF (Default):** Automatic response is not available.

**1/ 5/ 10/ 15/ 20/ 25/ 30:** Set calling ring time (second).

#### ■ Auto Pairing

When set to "ON", the Apple Auto Pairing function is turned on to automatically register the iPod touch or iPhone connected to this unit.

**ON (Default):** Uses Apple Auto Pairing function.

**OFF:** Not uses Apple Auto Pairing function.

#### ■ Sort Order

Sets how to arrange the cell-phone phonebook.

**First:** Arranges in the order of first name.

**Last (Default):** Arranges in the order of last name.

#### ■ Echo Cancel Level

Adjusts the level of echo cancellation.

Default is "0".

#### ■ Noise Reduction Level

Reduces the noises generated by surrounding environment without changing the microphone volume. Use this setting when the voice of caller is not clear. Default is "0".

\* Either the time interval for automatic answer set on this unit or the time interval set on the cell-phone, whichever is shorter takes effect.

### 6 Touch **OK**.

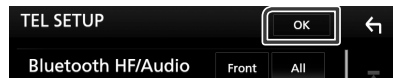

# Other External Components

## View Camera

### NOTE

- To connect a camera, see **P.89**.
- To use a rear view camera, a REVERSE lead connection is required. (**P.88**)
- The view of the front view camera or dashboard camera varies depending on the setting of **Dashboard Camera /Front Camera**.
- If **R-CAM Interruption** is set to on, the camera screen is displayed when you shift the gear to the reverse (R) position.

### Display the camera screen

- 1 Press the  button.

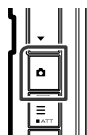

➤ View camera screen appears.

- 2 Adjust each item as follows.

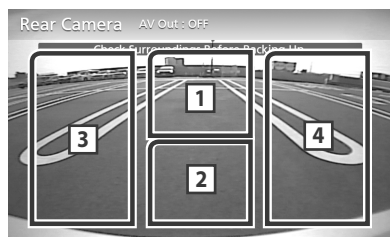

- 1 **Switching the View Camera**

Touch to change the front view camera or dashboard camera and rear view camera.

- 2 **Camera off**

Touch to exit the camera screen.

- 3 **Switching the Guideline**

Touching each time turns on or off the guideline. Available when **Dashboard Camera /Front Camera, Rear Camera** is set to **CMOS 3-Series Camera**.

- 4 **Switching the Angle**

Touch to change the camera angles:

Available when **Dashboard Camera / Front Camera, Rear Camera** is set to **CMOS 3-Series Camera**.

### Camera Setup

- 1 Press the  button.

➤ Popup menu appears.

- 2 Touch **SETUP**.

➤ SETUP Menu screen appears.

- 3 Touch **Camera**.



➤ Camera screen appears.

- 4 Set each item as follows.

#### ■ Rear Camera

**CMOS 3-Series Camera:** Select this when the CMOS-3xx series with ID 1 set is connected.

**Other (Default):** Select this when the other camera is connected.

#### ■ R-CAM Interruption

**ON:** Displays the picture from the rear view camera when you shift the gear to the reverse (R) position.

**OFF (Default):** Select this when no camera is connected.

#### ■ R-CAM Settings

If you select **CMOS 3-Series Camera** for **Rear Camera**, adjusts the CMOS-3xx series with ID 1 set. For details, see the instruction manual of your camera.

#### ■ Parking Guidelines

You can display parking guidelines to enable easier parking when you shift the gear to the reverse (R) position.

Default is "ON".



■ **Guidelines SETUP**

If you select **ON** for **Parking Guidelines**, adjust the parking guidelines. See **To adjust the parking guidelines (P.65)**.

■ **Dashboard Camera /Front Camera**

**Dashboard Camera:** Select this when the dashboard camera is connected.

**CMOS 3-Series Camera:** Select this when the CMOS-3xx series with ID 2 set is connected.

**Other:** Select this when the other camera is connected.

**OFF (Default):** Select this when no camera is connected.

■ **F-CAM Settings**

If you select **CMOS 3-Series Camera** for **Dashboard Camera /Front Camera**, adjusts the CMOS-3xx series with ID 2 set. For details, see the instruction manual of your camera.

■ **Front Camera Mirror Image**

If you select **Other** for **Dashboard Camera /Front Camera**.

**ON:** Displays the picture from the front view camera horizontally reversed.

**OFF (Default):** Displays the picture from the front view camera as it is.

**To adjust the parking guidelines**

**NOTE**

- Install the rear view camera in the appropriate position according to the instructions supplied with the rear view camera.
- When adjusting the parking guidelines, make sure to use the parking brake to prevent the car from moving.

- 1 Touch **ON of Parking Guidelines** in the Camera screen. (P.64)
- 2 Touch **Guidelines SETUP** in the Camera screen.
- 3 Adjust the parking guidelines by selecting the  mark.

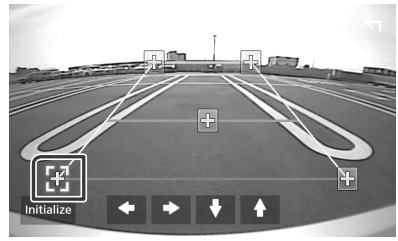

4 **Adjusting the position of the selected mark.**

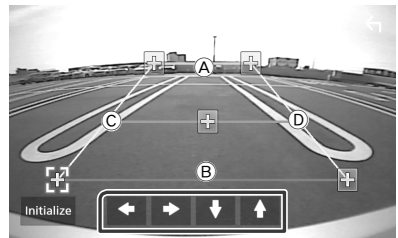

Make sure that **A** and **B** are horizontally parallel, and that **C** and **D** are the same length.

**NOTE**

- Touch **Initialize** and after touch **Yes** to set all the  marks to the initial default position.

**Use Dashboard Camera**

A Dashboard Camera, DRV-N520 (optional accessory), connected to this unit lets you play video-recorded data and so on.

For details, see the instruction manual of the Dashboard Camera DRV-N520 (optional accessory).

**NOTE**

- To connect a camera, see **P.90**.
- Sets the dashboard camera/front camera as **Dashboard Camera**. (P.65)

 **Display the dashboard camera screen**

- 1 Press the  button.
  - View camera screen appears.



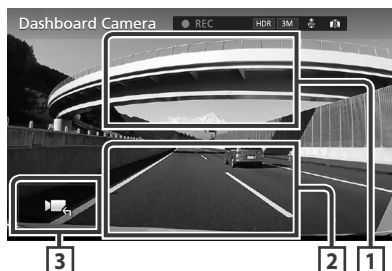

**1 Switching the View Camera**

Touch to change the dashboard view camera and rear view camera.

**2 Camera off**

Touch to exit the camera screen.

**3 Key display**

Touch to display the dashboard camera control buttons.



## External audio/video players— AV-IN

**Start playback**

- 1 Connect an external component to the AV-IN input terminal. (P.89)
- 2 Select AV-IN as the source. (P.11)
- 3 Turn on the connected component and start playing the source.







## OEM Features Operation

By connecting this unit to the bus system of the vehicle using an iDataLink (commercially available), this unit can access the satellite radio source provided for the vehicle and vehicle information can be displayed on this unit.

- 1 Press the  button.
  - HOME screen appears.
- 2 Touch  on the HOME screen.

**3 Touch icon.**



	• Displays the control screen of the satellite radio source provided for the vehicle.
	• Displays the control screen of the media player source provided for the vehicle.
	• Displays the control screen of the Bluetooth Hands Free function provided for the vehicle.
	• Displays the control screen of the Bluetooth streaming source provided for the vehicle.
	• Displays information about the instruments such as a speedometer.
	• Displays information about the air conditioner of the vehicle. *
	• Displays information about the Parking Distance Sensor of the vehicle.
	• Displays information about the tire pressures of the vehicle. *
	• Displays information about the Radar Detector. *

\* These ADS adapter features are displayed as the widget on the Home screen. (P.10) You can display these screens by touching the widget.

**NOTE**

- Displayable screens, button names, and screen names vary depending on the type of the connected iDataLink and the model of the vehicle. For more details, access the following URL:  
[www.idatalink.com/](http://www.idatalink.com/)

# Setting Up

## Monitor Screen Setup

You can adjust image quality in video, menu screen, etc.

- 1 Press the **≡** button.  
➤ Popup menu appears.

- 2 Touch **Screen Adjustment**.



- Screen Control screen appears.

- 3 Adjust each item as follows.

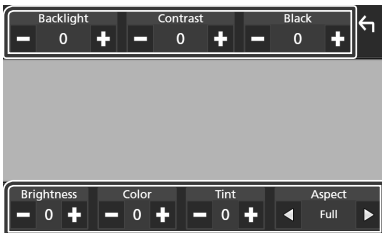

- **Backlight / Contrast / Black / Brightness / Color / Tint**

Adjusts each item.

- **Aspect**

Select screen mode.

**Full:** Changes the aspect ratio of video and displays fully on the screen.

**Normal:** Displays with 4:3 ratio.

**Auto:**

DVD, VCD and disc media: Video of 16:9 ratio is displayed in Full and video of 4:3 ratio is displayed in Regular.

USB device: Displays video fully on vertical or horizontal with no ratio change.

### NOTE

- Adjusting items are different depending on the current source.

## System Setup

### NOTE

- Each operation in this section can be started from the multi function menu.

- 1 Press the **≡** button.  
➤ Popup menu appears.

- 2 Touch **SETUP**.

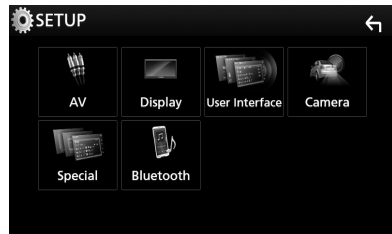

See the following section for each setting.

- Set up AV (**P.71**)
- Set up display (**P.69**)
- Set up the user interface (**P.68**)
- Set up camera (**P.64**)
- Set up special (**P.69**)
- Set up Bluetooth (**P.55**)

## User Interface Setup

You can setup user interface parameters.

- 1 Press the  button.
  - Pop-up menu appears.
- 2 Touch **SETUP**.
  - SETUP screen appears.
- 3 Touch **User Interface**.



➤ User Interface screen appears.

### 4 Set each item as follows.

#### ■ Beep

Turns the key touch tone on or off.  
Default is "ON".

#### ■ Parking Assist Display

When an ADS adapter is connected, you can display information about obstacles around the car.

**ON:** Always displays information.

**Dyn.** (Default): Displays information when the sensor detects obstacles.

**OFF:** Cancels.

This can be set when the iDataLink (commercially available) is connected.

#### ■ Parking Assist Position

Select where information about obstacles is displayed on the screen (left or right).

"Left"/"Right" (Default)

This can be set when the iDataLink (commercially available) is connected.

#### ■ Language Select

Selects a language.

#### ■ Touch Panel Adjust

Adjust the sensing position of touch panel. (P.68)

#### ■ Clock

**GPS-SYNC** (Default): Synchronizes the clock time with the GPS.

**Manual:** Sets the clock manually

#### ■ Time Zone

If you select **Manual** for Clock, select the time zone.

#### ■ Clock Adjust

If you select **Manual** for Clock, adjust the date and time manually. (P.68)

### Adjust the date and time manually.

- 1 Touch **Clock** in the User Interface screen.
- 2 Touch **Manual**.
- 3 Touch **Time Zone** in the User Interface screen.
- 4 Select the time zone.
- 5 Touch **Clock Adjust** in the User Interface screen.
- 6 Adjust the date, then adjust the time.

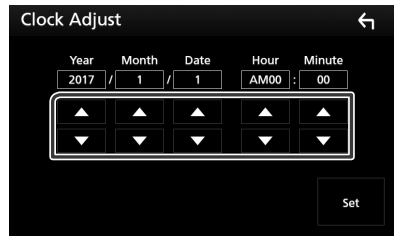

### 7 Touch **Set**.

### Touch panel adjustment

- 1 Touch **Touch Panel Adjust** on the User Interface screen.
  - Touch Panel Adjust screen appears.
- 2 Follow the instruction on the screen and long touch the center of each .

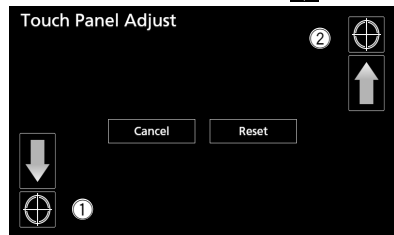

#### NOTE

- To cancel the touch panel adjustment, touch **Cancel**.
- To reset to the initial status, touch **Reset**.

## Special Setup

You can setup Special parameters.

- 1 Press the **≡** button.  
➤ Popup menu appears.
- 2 Touch **SETUP**.  
➤ SETUP screen appears.
- 3 Touch **Special**.

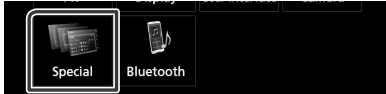

➤ Special screen appears.

- 4 Set each item as follows.

### ■ DEMO

Set the demonstration mode. Default is "ON".

### ■ Manual Power OFF

Assigns the function of the  button when held.

**AV OFF:** Turns off the screen and audio. Interrupts from incoming hands-free calls, rear camera views and so on are functional, though.

**Complete OFF** (Default): Switches off the power. Interrupts are not functional.

### ■ SETUP Memory

Locks or unlocks the Audio SETUP Memory/Recall/Clear.

### ■ Audio SETUP Memory

Memorizes the current audio setting.

- Fader/ Balance, Speaker / X'over, Equalizer (User Preset, SW Level), Position/DTA, Sound Effect (P.72)

### ■ Audio SETUP Recall

Recalls the memorized audio setting.

### ■ Audio SETUP Clear

Clears the AUDIO SETUP Memory and the currently memorized audio setting.

### ■ Software Information

Check the software version of this unit. (P.69)

### ■ Open Source Licenses

Displays the open source licenses.

### ■ Initialize

Touch **Initialize** and then touch **Yes** to set all the settings to the initial default settings.

- Audio SETUP Memory is not initialized.

## Software Information

Check the software version of this unit.

- 1 Touch **Software Information** in the Special screen.
- 2 Confirm the software version.

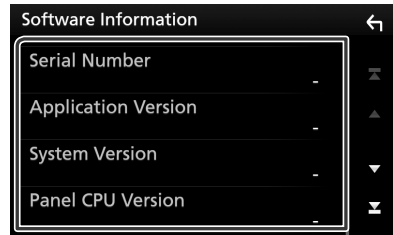

### NOTE

- For how to update the software, see the relevant update procedure manual which comes with the software.

## Display Setup

- 1 Press the **≡** button.  
➤ Popup menu appears.
- 2 Touch **SETUP**.  
➤ SETUP screen appears.
- 3 Touch **Display**.



➤ Display screen appears.

- 4 Set each item as follows.

### ■ Dimmer

Select dimmer mode.

**OFF:** The display and buttons do not dim.

**ON:** The display and buttons dim.

**SYNC** (Default): Turns the dimmer function on or off when the vehicle light control switch is turned on or off.

## Setting Up

### ■ OSD Clock

Select if you want to display the clock while watching DVD video, etc.  
"ON" (Default)/ "OFF"

### ■ Key Color

You can set the button illumination color.  
**(P.70)**

### ■ Background

Changing background image or color.  
**(P.70)**

### ■ Viewing Angle

If it is hard to see the image on the screen even, adjust the viewing angle. The smaller the (negative) value, the more whitish the image on the screen looks.  
"0" (Default)/ "-1"/ "-2"/ "-3"

## ■ Customizing the key color

You can set the button illumination color.

- 1 Touch **Key Color** in the Display screen.
- 2 Touch the desired color.



### ■ User

The color you have set in the process of **Adjust** is registered.

### ■ Scan

You can set the key color to continuously scan through the color spectrum.

### ■ Car Color

This can be selected when a compatible ADS adapter is connected.

- 3 Touch .

## To register original color

You can register your original color.

- 1 Touch **User** in the Key Color screen.
- 2 Touch **Adjust**.

- 3 Use **—** and **+** to adjust each color value.

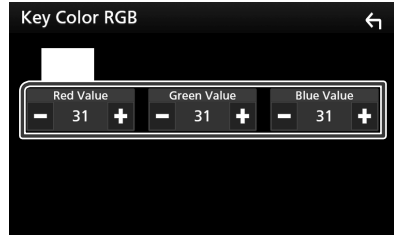

- 4 Touch .

## ■ Change background image or color

- 1 Touch **Background** in the Display screen.
- 2 Select an image.

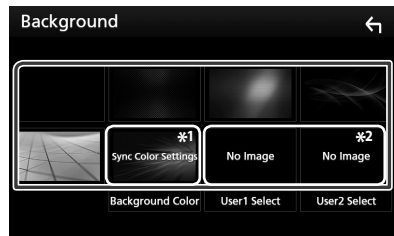

\*1 Select a background color in advance.

\*2 Select an original image in advance.

## To select background color

- 1 Touch **Background Color** in the Background screen.
- 2 Select a background color.



\*1 The color you have selected at **Key Color** is added on the image. If you select "Scan" at **Key Color**, you cannot select this image.

- 3 Touch .

### To register original image

You can load an image from the connected USB device and set it for the background image.

Before operating this procedure, it is necessary to connect the device which has the image to load.

- 1 Touch **User1 Select** or **User2 Select** in the Background screen.
- 2 Select the image to load.

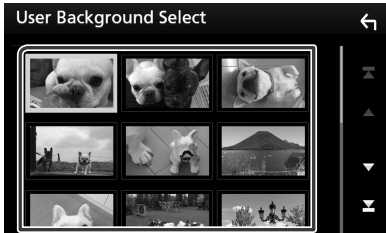

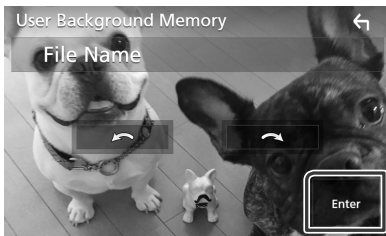

- 3 Touch **Enter**.



- The selected image is loaded and the display returns to the Background screen.

#### NOTE

- Touching  rotates counter clockwise.
- Touching  rotates clockwise.
- Picture files: JPEG (.jpg, .jpeg), PNG (.png), BMP (.bmp)

## AV Setup

You can set AV parameters.

- 1 Press the  button.
  - Popup menu appears.
- 2 Touch **SETUP**.
  - SETUP screen appears.
- 3 Touch **AV**.



- AV screen appears.

- 4 Set each item as follows.

#### ■ AV-OUT

You can select an AV source to be output from the AV OUTPUT port.

OFF, AV-IN, DISC, USB, or iPod

You cannot select iPod if it is connected via Bluetooth.

If you select USB, iPod, Disc, Spotify, Pandora, Bluetooth audio, Apple CarPlay or Android Auto as the main source, you cannot select USB or iPod as the AV output source.

#### ■ CarPlay Sidebar

Select the position of the control bar (left or right) shown on the touch panel.

"Left" (Default)/ "Right"

#### ■ OEM SETUP

Confirm the information about/ change the settings for using the ADS adapter.

# Controlling Audio

## NOTICE

• Each operation in this section can be started from the multi function menu.

You can adjust the various settings such as audio balance or subwoofer level.

- 1 Press the **≡** button.  
➤ Popup menu appears.
- 2 Touch **Audio**.

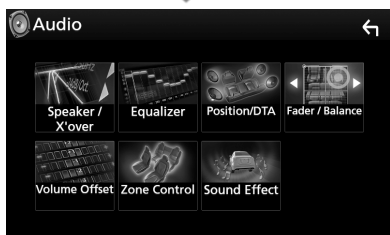

See the following section for each setting.

- Set up speaker/ X'over (P.72)
- Controlling equalizer (P.74)
- Set listening position/ DTA (P.77)
- Controlling general audio (Fader / Balance) (P.73)
- Set volume offset (P.75)
- Performing zone control (P.75)
- Set sound effect (P.76)

## Speaker/ X'over setup

- 1 Press the **≡** button.  
➤ Popup menu appears.
- 2 Touch **Audio**.  
➤ Audio screen appears.
- 3 Touch **Speaker/X'over**.

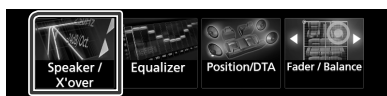

- 4 Select a car type.

You can setup the car type and speaker network, etc.

If your car type is selected, the Delay Time Alignment is set automatically (for timing adjustment of sound output for each channel) to have the highest surround effects.



- 5 Touch the speaker (1) you wish to adjust and set each item (2) as follows.

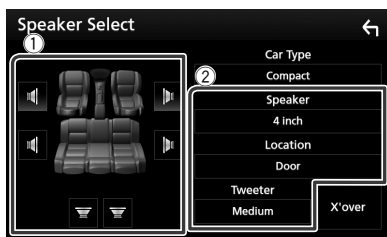

### ■ Speaker

You can select a speaker type and its size to get the best sound effects.

When the speaker type and size are set, the speaker crossover network is set automatically.

### ■ Location (Only for Front, Rear)

Select the speaker position you have fixed.



■ **Tweeter (Only for Front)**

You can set the tweeter when you are selecting front speakers.

None, Small, Medium, Large

■ **X'over**

Displays the speaker crossover setup screen.

You can adjust the crossover setup that was set automatically when you selected the speaker type.

For details, see **Crossover network setup (P.73)**

■ **Crossover network setup**

You can set a crossover frequency of speakers.

1 **Touch X'over.**



2 **Touch the speaker to set.**



3 **Set each item as follows.**

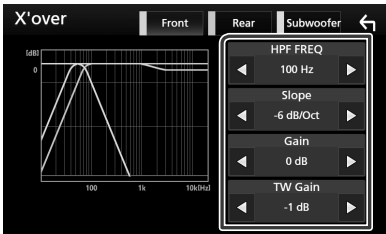

■ **HPF FREQ**

High Pass Filter adjustment. (When front or rear speaker is selected on Speaker Select screen)

■ **LPF FREQ**

Low Pass Filter adjustment. (When subwoofer is selected on Speaker Select screen)

■ **Slope\*1**

Sets a crossover slope.

■ **Gain**

Adjusts the front speaker, rear speaker, or subwoofer level.

■ **TW (Tweeter) Gain \*2**

Adjusts the tweeter level. (When front is selected on Speaker Select screen)

■ **Phase Inversion\*3**

Sets the phase of subwoofer output.

Check **Phase Inversion** to shift the phase 180 degrees. (When subwoofer is selected on Speaker Select screen)

\*1 Only when "LPF FREQ"/"HPF FREQ" is set to a mode other than "Through" in **X'over**.

\*2 Only when "Tweeter" is set to "Small", "Medium", "Large" in **Speaker Setup**.

\*3 Only when "Subwoofer" is set to a mode other than "None" in **Speaker Setup**.

**Controlling General Audio**

1 **Press the ≡ button.**

➤ Pop up menu appears.

2 **Touch Audio.**

➤ Audio screen appears.

3 **Touch Fader / Balance.**

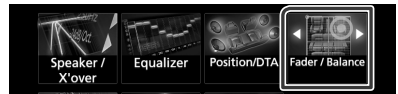

4 **Set each item as follows.**

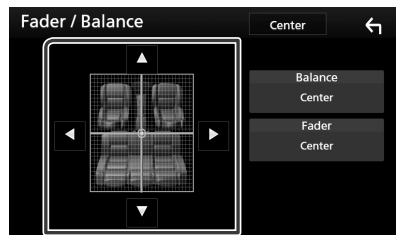

■ **Fader / Balance**

Adjust the volume balance around the touched area.

◀ and ▶ adjust the right and left volume balance.

▲ and ▼ adjust the front and rear volume balance.

■ **Center**

Clear the adjustment.

## Equalizer Control

You can adjust equalizer by selecting the optimized setting for each category.

- 1 Press the  button.
  - Popup menu appears.
- 2 Touch **Audio**.
  - Audio screen appears.
- 3 Touch **Equalizer**.



- 4 Touch the screen and set the Graphic Equalizer as desired.

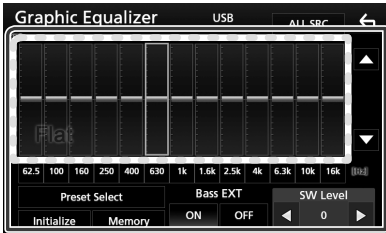

■ **Gain level (dotted frame area)**  
Adjust the gain level by touching the each frequency bar.

You can select frequency bar and adjust its level by ▲, ▼.

■ **Preset Select**  
Displays the screen to recall the preset equalizer curve.

■ **Memory**  
Saves the adjusted equalizer curve from "User1" to "User4".

■ **Initialize**  
The current EQ curve returns to flat.

■ **ALL SRC**  
Apply the adjusted equalizer to all sources. Touch **ALL SRC** and then touch **OK** on the confirmation screen.

■ **Bass EXT (Bass Extend Settings)**  
When turned on, the frequency lower than 62.5 Hz is set to the same gain level as 62.5 Hz.

■ **SW Level**  
Adjusts the subwoofer volume. This setting is not available when subwoofer is set to "None". See **Speaker/ X'over setup (P.72)**.

### Recall the EQ curve

- 1 Touch **Preset Select**.
- 2 Select EQ curve.

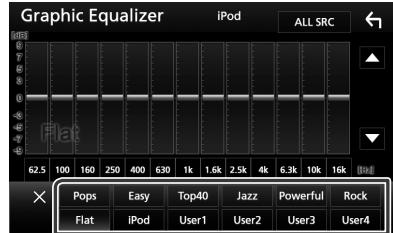

#### NOTE

- **iPod** is available only during iPod source.

### Save the EQ curve

- 1 Adjust the EQ curve.
- 2 Touch **Memory**.
- 3 Select where to save.

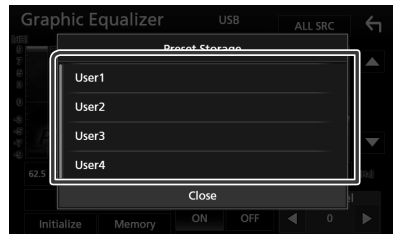

## Volume Offset

Finely adjust the volume of the current source to minimize the difference in volume between different sources.

- 1 Press the **≡** button.
  - Popup menu appears.
- 2 Touch **Audio**.
  - Audio screen appears.
- 3 Touch **Volume Offset**.

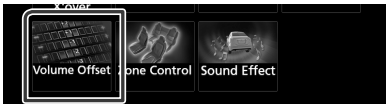

- 4 Touch **+** or **-** to adjust the level.



### ■ Initialize

Returns to the initial settings.

\* If you have increased the volume first, then reduced the volume using the "Volume Offset", the sound generated if you suddenly switch to another source may be extremely loud.

## Zone Control

You can select different sources for both front and rear positions in the vehicle.

- 1 Press the **≡** button.
  - Popup menu appears.
- 2 Touch **Audio**.
  - Audio screen appears.
- 3 Touch **Zone Control**.



➤ Zone Control screen appears.

- 4 Touch **Zone Select**.
- 5 Touch **Dual Zone**.

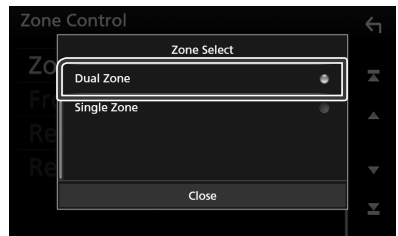

- 6 Set each source as follows.

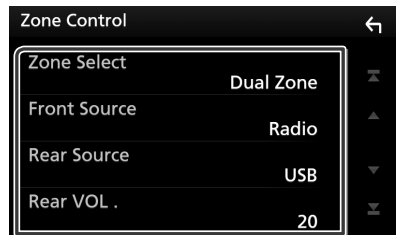

### ■ Zone Select

Touch **Single Zone** to turn off the dual zone function.

### ■ Front Source Rear Source

Select the audio source for each.

### ■ Rear VOL.

Adjusts the rear source volume.

### NOTE

- When the rear speaker sound is switched, the audio source that is output at the AV OUTPUT terminal is also switched to the same source.
- When the dual zone function is set to on, the following functions are not available.
  - Output from the subwoofer
  - Subwoofer Level/ Bass Boost (**P.76**)
  - Equalizer Control/ Sound Effect/ Listening Position (**P.74, 76, 77**)
  - Speaker Setup (**P.72**)
  - High-resolution Sound Source File Playback
- You cannot select iPod if it is connected via Bluetooth.
- If you select USB, iPod, Disc, Bluetooth audio, Apple CarPlay or Android Auto as the Front Source, you cannot select USB or iPod as the Rear Source.

## Sound Effect

You can set sound effects.

- 1 Press the  button.**
  - Pop-up menu appears.
- 2 Touch **Audio**.**
  - Audio screen appears.
- 3 Touch **Sound Effect**.**



- 4 Set each item as follows.**

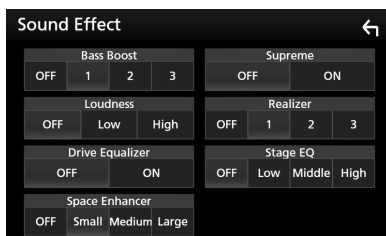

### ■ Bass Boost

Sets the amount of bass boost among “OFF”/ “1”/“2”/“3”.

### ■ Loudness

Sets the amounts of boost of low and high tones.

“OFF”, “Low”, “High”

### ■ Drive Equalizer

Reduces the driving noise by raising the bandwidth.

“OFF”, “ON”

### ■ Space Enhancer

Select the feeling of sound space enhancement.

“OFF”/“Small”/“Medium”/“Large”.

This setting is not available during HD Radio tuner source.

### ■ Supreme

Turns ON/OFF the Supreme function.

Technology to extrapolate and supplement with proprietary algorithm, the high-frequency range that is cut off when encoding.

■ **Realizer**

Virtually makes the sound more realistic using the Digital Signal Processor (DSP) system.

Select the level from "OFF"/"1"/"2"/"3".

■ **Stage EQ**

You can adjust the height of speakers virtually to suit your listening position. "OFF"/"Low"/"Middle"/"High".

## Listening Position/ DTA

Listening Position/DTA allows you to improve the sound field depending on the position of the seat you sit.

Listening Position/DTA allows you to set "Listening Position" and "Front Focus". You cannot set both at the same time.

- 1 Press the  button.
  - ▶ Pop up menu appears.
- 2 Touch **Audio**.
  - ▶ Audio screen appears.
- 3 Touch **Position/DTA**.



- Set up Listening Position (**P.77**)
- Set up Front Focus (**P.78**)

### Listening Position

Adjust the sound delay time as nearer speakers to the selected seat have more delay time, so that the sound from each speaker arrive a listener at the same time.

- 1 Touch **Listening Position** in the Position/DTA screen.
- 2 Select listening position from **Front R** (Right front), **Front L** (Left front), **Front All** (All front), and **All**.

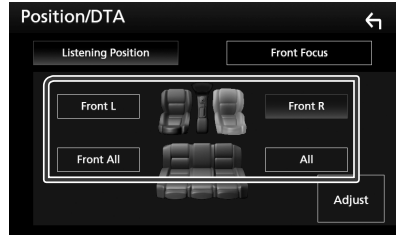

### Position DTA control

You can fine-adjust your listening position.

- 1 Touch **Adjust**.
- 2 Touch **Delay**.
- 3 Touch **◀** or **▶** to adjust the delay time of the selected speaker.



- 4 Touch **Level**.
- 5 Touch **◀** or **▶** to adjust the sound level of the selected speaker.

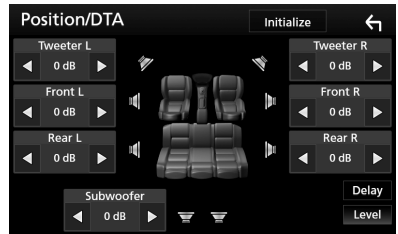

#### NOTE

- To return to the initial setting of Delay and Level, touch **Initialize** and **YES** in the confirmation screen.

### Front Focus

This is the function to focus the imaginary sound image in front of the selected seat.

1 Touch **Front Focus** in the Position/DTA screen.

2 Select a front focus position.

For **Front All** and **All**, select Priority L or R depending on which side you want to put the imaginary sound image.



### Front Focus fine adjustment

1 Touch **Adjust**.

2 Touch **Delay**.

3 Set each item as follows.

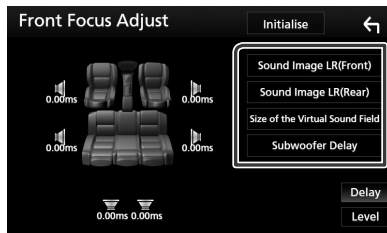

#### ■ Sound Image LR (Front)

Adjust the sound image to focus on in front of front seats.

#### ■ Sound Image LR (Rear)

Adjust the sound image to focus on in front of rear seats.

#### ■ Size of the Virtual Sound Field

Adjust the size of sound image to meet your taste. If the sound image is shifted from the front, adjust it by **Sound Image LR (Front)** or **Sound Image LR (Rear)**.

#### ■ Subwoofer Delay

Adjust the delay time of subwoofer.

4 Touch **Level**.

5 Touch **◀** or **▶** to adjust the sound level of the selected speaker.

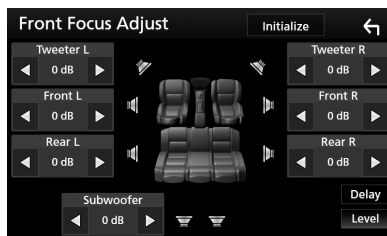

### NOTE

- To return to the initial setting of Delay and Level, touch **Initialize** and **YES** in the confirmation screen.

# Remote control

This unit can be operated using the remote control KNA-RCDV331 (optional accessory).

## ▲ CAUTION

- Put the remote control in a place where it will not move during braking or other operations. A dangerous situation could result, if the remote control falls down and gets wedged under the pedals while driving.
- Do not leave the battery near fire or under direct sunlight. A fire, explosion or excessive heat generation may result.
- Do not recharge, short, break up or heat the battery or place it in an open fire. Such actions may cause the battery to leak fluid. If spilled fluid comes in contact with your eyes or on clothing, immediately rinse with water and consult a physician.
- Place the battery out of reach of children. In the unlikely event that a child swallows the battery, immediately consult a physician.

## Battery Installation

If the remote control operates only over shorter distances or does not operate at all, it is possible that the batteries are depleted. In such instances, replace the both batteries with new ones.

- 1 Insert two "AAA"/"R03"-size batteries with the ⊕ and ⊖ poles aligned properly, following the illustration inside the case.

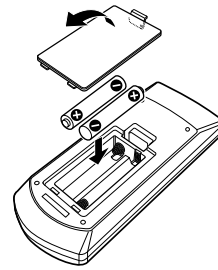

## Functions of the Remote control Buttons

### Switch the operation mode

The functions operated from the remote control differ depending on the position of the mode switch.

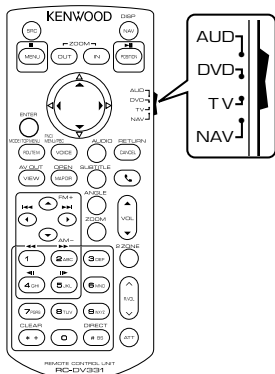

#### ■ AUD mode

Switch to this mode when controlling a selected source or tuner source, etc.

#### ■ DVD mode

Switch to this mode when playing a disc media including DVD, VCD, and CD.

#### ■ NAV mode

Not used.

#### ■ TV mode

Not used.

#### NOTE

- When controlling a player that is not integrated in the unit, select "AUD" mode.

### Direct search mode

Using the remote control, you can jump directly to the desired file, track chapter, etc. with entering the number corresponding to the content.

#### NOTE

- This operation cannot be performed for USB device and iPod.

### 1 Press the #BS button several times until the desired content appears.

The available contents are different depending on the source.

#### ■ DVD

Title number/Chapter number

#### ■ VCD 1.X and 2.X (PBC OFF)

Track number

#### ■ VCD 2.X (PBC ON)

Scene number/Track number

#### ■ Music CD

Track number

#### ■ HD Radio tuner

Frequency value/Channel number

#### ■ SiriusXM

Channel number

### 2 Enter the number of the content you want to play using the numeric keypad.

### 3 For DVD or VCD, music CD, press the ENTER button.

For radio, press the ◀ or ▶ button.

▶ The content you entered is played.



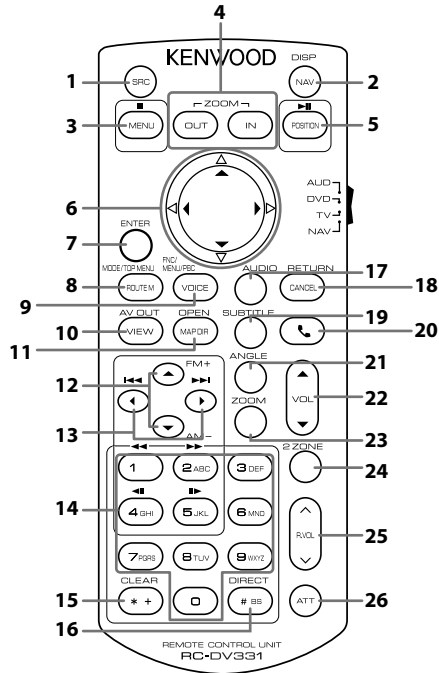

	Key Name	Mode switch	Function
1	SRC	AUD, DVD	Switches to the source to be played. In hands-free mode, hangs up the phone.
2	NAV	–	Displays the control screen of current source.
3	MENU	DVD	Stops playing and memorizes the last point where the disc stopped. The last point is deleted by pressing twice.
4	OUT, IN	–	Not used.
5	POSITION	AUD, DVD	Pauses the track or file, and resumes playing by pressing twice. During radio, HD Radio, and SiriusXM source in AUD mode, switches the seek mode.
6	Cursor Key	DVD	Moves the cursor in the DVD menu.
7	ENTER	AUD, DVD	Performs the selected function.
8	ROUTE M	AUD	Screen mode changes each time you press this key during video playback.
		DVD	Returns to the DVD top menu.
9	VOICE	AUD	Displays the control screen of current source. (USB, iPod, DISC)
		DVD	Displays the DVD menu. Turns the playback control on or off while playing VCD.
10	VIEW	AUD, DVD	Switches the AV source to be output.
11	MAP DIR	–	Not used.

## Remote control

	Key Name	Mode switch	Function
12	▲/▼	AUD, DVD	Selects the folder to be played. During radio and HD Radio source in AUD mode, select FM/ AM band to be received. During SiriusXM source in AUD mode, switches the bands to be received.
13	◀/▶	AUD, DVD	Selects the track or file to be played. During radio, HD Radio, and SiriusXM source in AUD mode, switches to broadcast stations received by the unit.
14	Numeric Keypad	AUD	Specifies the number to search in direct search. For details on the direct search mode, see <b>Direct search mode (P.80)</b> .
		DVD	<ul style="list-style-type: none"> <li>• Press <b>1 2</b> to fast forward/backward.</li> <li>• Press <b>4 5</b> to slow forward/backward. Switches the slow playback speed each time you press this key.*</li> </ul> *DVD only
15	* +	DVD	Clears the number.
16	# BS	AUD, DVD	Switches to the direct search mode. For details on the direct search mode, see <b>Direct search mode (P.80)</b> .
17	AUDIO	DVD	Switches the voice language each time you press this key.
18	CANCEL	DVD	Displays previous screen.
19	SUBTITLE	DVD	Switches the subtitle language.
20		–	When a call comes in, answers the call.
21	ANGLE	DVD	Switches the picture angle each time you press this key.
22	Vol ▲▼	–	Adjusts the volume.
23	ZOOM	DVD	Switches the zoom ratio (2, 3, 4, Off) each time you press this key.
24	2 ZONE	AUD, DVD	Switches the Dual Zone function on and off.
25	R.VOL ^∨	–	Adjusts volume at rear when the Dual Zone function is on.
26	ATT	–	Lowers the volume by pressing the key once. Restores the previous volume by pressing the key twice.

# Connection/Installation

## Before Installation

Before installation of this unit, please note the following precautions.

### ▲ WARNINGS

- If you connect the ignition wire (red) and the battery wire (yellow) to the car chassis (ground), you may cause a short circuit, that in turn may start a fire. Always connect those wires to the power source running through the fuse box.
- Do not cut out the fuse from the ignition wire (red) and the battery wire (yellow). The power supply must be connected to the wires via the fuse.

### ▲ CAUTION

- Install this unit in the console of your vehicle. Do not touch the metal part of this unit during and shortly after the use of the unit. Metal part such as the heat sink and enclosure become hot.

### NOTE

- Mounting and wiring this product requires skills and experience. For best safety, leave the mounting and wiring work to professionals.
- Make sure to ground the unit to a negative 12V DC power supply.
- Do not install the unit in a spot exposed to direct sunlight or excessive heat or humidity. Also avoid places with too much dust or the possibility of water splashing.
- Do not use your own screws. Use only the screws provided. If you use the wrong screws, you could damage the unit.
- If the power is not turned ON ("There is an error in the speaker wiring. Please check the connections." is displayed), the speaker wire may have a short-circuit or touched the chassis of the vehicle and the protection function may have been activated. Therefore, the speaker wire should be checked.
- If your car's ignition does not have an ACC position, connect the ignition wires to a power source that can be turned on and off with the

ignition key. If you connect the ignition wire to a power source with a constant voltage supply, such as with battery wires, the battery may be drained.

- If the console has a lid, make sure to install the unit so that the front panel will not hit the lid when closing and opening.
- If the fuse blows, first make sure the wires aren't touching to cause a short circuit, then replace the old fuse with one with the same rating.
- Insulate unconnected wires with vinyl tape or other similar material. To prevent a short circuit, do not remove the caps on the ends of the unconnected wires or the terminals.
- Connect the speaker wires correctly to the terminals to which they correspond. The unit may be damaged or fail to work if you share the ⊖ wires or ground them to any metal part in the car.
- When only two speakers are being connected to the system, connect the connectors either to both the front output terminals or to both the rear output terminals (do not mix front and rear). For example, if you connect the ⊕ connector of the left speaker to a front output terminal, do not connect the ⊖ connector to a rear output terminal.
- After the unit is installed, check whether the brake lamps, blinkers, wipers, etc. on the car are working properly.
- Mount the unit so that the mounting angle is 30° or less.
- This unit has the cooling fan to decrease the internal temperature. Do not mount the unit in a place where the cooling fan of the unit is blocked. Blocking these openings will inhibit the cooling of the internal temperature and result in malfunction.

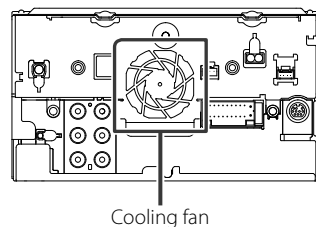





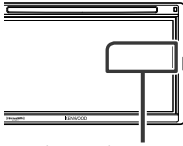



## Connection/Installation

- Do not press hard on the panel surface when installing the unit to the vehicle. Otherwise scars, damage, or failure may result.
- Reception may drop if there are metal objects near the Bluetooth antenna.

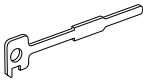

Bluetooth antenna unit

## Supplied accessories for installation

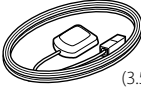
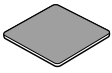
①		<b>x1</b>
②	 (Black 1 m)	<b>x1</b>
③ <sup>(1)</sup>	 (Gray 1 m)	<b>x1</b>
④	 (3 m)	<b>x1</b>
⑤ <sup>(1)</sup>		<b>x2</b>
⑥	 (M5 x 8 mm)	<b>x6</b>
⑦	 (M5 x 8 mm)	<b>x6</b>
⑧ <sup>(1)</sup>		<b>x1</b>
⑨	 (3.5 m)	<b>x1</b>
⑩		<b>x1</b>

<sup>(1)</sup> DDX6904S only

## ■ Installation procedure

- 1) To prevent a short circuit, remove the key from the ignition and disconnect the  $\ominus$  terminal of the battery.
- 2) Make the proper input and output wire connections for each unit.
- 3) Connect the speaker wires of the wiring harness.
- 4) Connect the wiring harness wires in the following order; ground, battery, ignition.
- 5) Connect the wiring harness connector to the unit.
- 6) Install the unit in your car.
- 7) Reconnect the  $\ominus$  terminal of the battery.
- 8) Perform the Initial Setup.  
See **Initial setup (P.8)**.

## Installing the unit

### ■ Non-Japanese cars (DDX6904S)

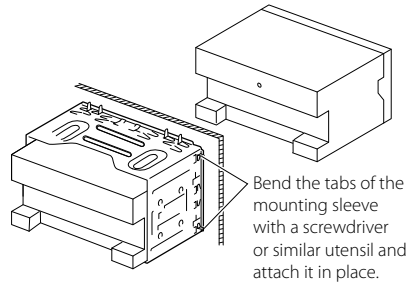

### ■ Japanese cars

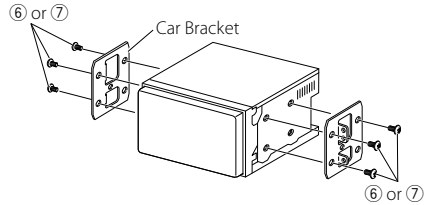

#### NOTE

- Make sure that the unit is installed securely in place. If the unit is unstable, it may malfunction (eg, the sound may skip).

### ■ Trim plate (DDX6904S)

- 1) Attach accessory ⑧ to the unit.

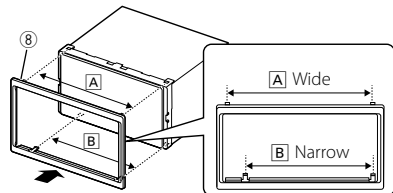

### GPS antenna

GPS antenna is installed inside of the car. It should be installed as horizontally as possible to allow easy reception of the GPS satellite signals.

To mount the GPS antenna inside your vehicle:

- 1) Clean your dashboard or other surface.
- 2) Remove the separator of the metal plate (accessory ⑩).
- 3) Press the metal plate (accessory ⑩) down firmly on your dashboard or other mounting surface. You can bend the metal plate (accessory ⑩) to conform to a curved surface, if necessary.
- 4) Remove the separator of the GPS antenna (accessory ⑨), and stick the antenna to the metal plate (accessory ⑩).

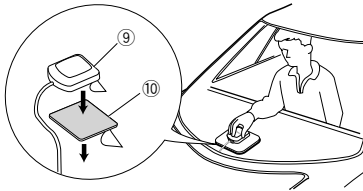

#### NOTE

- Depending on the type of car, reception of the GPS satellite signals might not be possible with an inside installation.
- Please install this GPS antenna in an area away from any antennas that are used with CB radios or satellite televisions.
- The GPS antenna should be installed at a position that is spaced at least 12 inch (30 cm) from cellular phone or other transmitting antennas. Signals from the GPS satellite may be interfered with by these types of communication.
- Painting the GPS antenna with (metallic) paint may cause a drop in performance.

### Microphone unit

- 1) Check the installation position of the microphone (accessory ④).
- 2) Clean the installation surface.
- 3) Remove the separator of the microphone (accessory ④), and stick the microphone to the place shown below.
- 4) Wire the microphone cable up to the unit with it secured at several positions using tape or other desired method.
- 5) Adjust the direction of the microphone (accessory ④) to the driver.

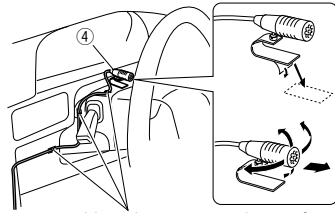

Fix a cable with a commercial item of tape.

## ■ Removing the trim plate (DDX6904S)

- 1) Engage the catch pins on the extraction key (accessory ⑤) and remove the two locks on the lower level.

Lower the trim plate (accessory ⑧) and pull it forward as shown in the figure.

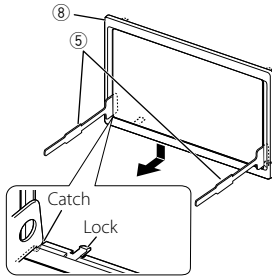

### NOTE

- The trim plate can be removed from the top side in the same manner.

- 2) When the lower level is removed, remove the upper two locations.

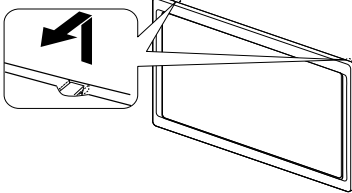

## ■ Removing the unit (DDX6904S)

- 1) Remove the trim plate by referring to step 1 in "Removing the trim plate".
- 2) Insert the two extraction keys (accessory ⑤) deeply into the slots on each side, as shown.

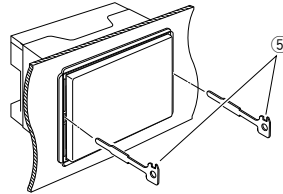

- 3) Lower the extraction key toward the bottom, and pull out the unit halfway while pressing towards the inside.

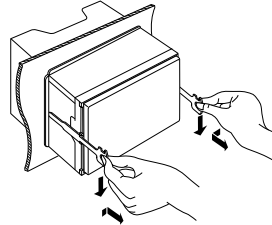

### NOTE

- Be careful to avoid injury from the catch pins on the extraction key.

- 4) Pull the unit all the way out with your hands, being careful not to drop it.

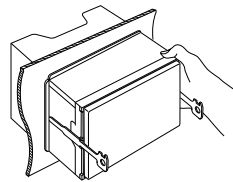

## Connecting wires to terminals

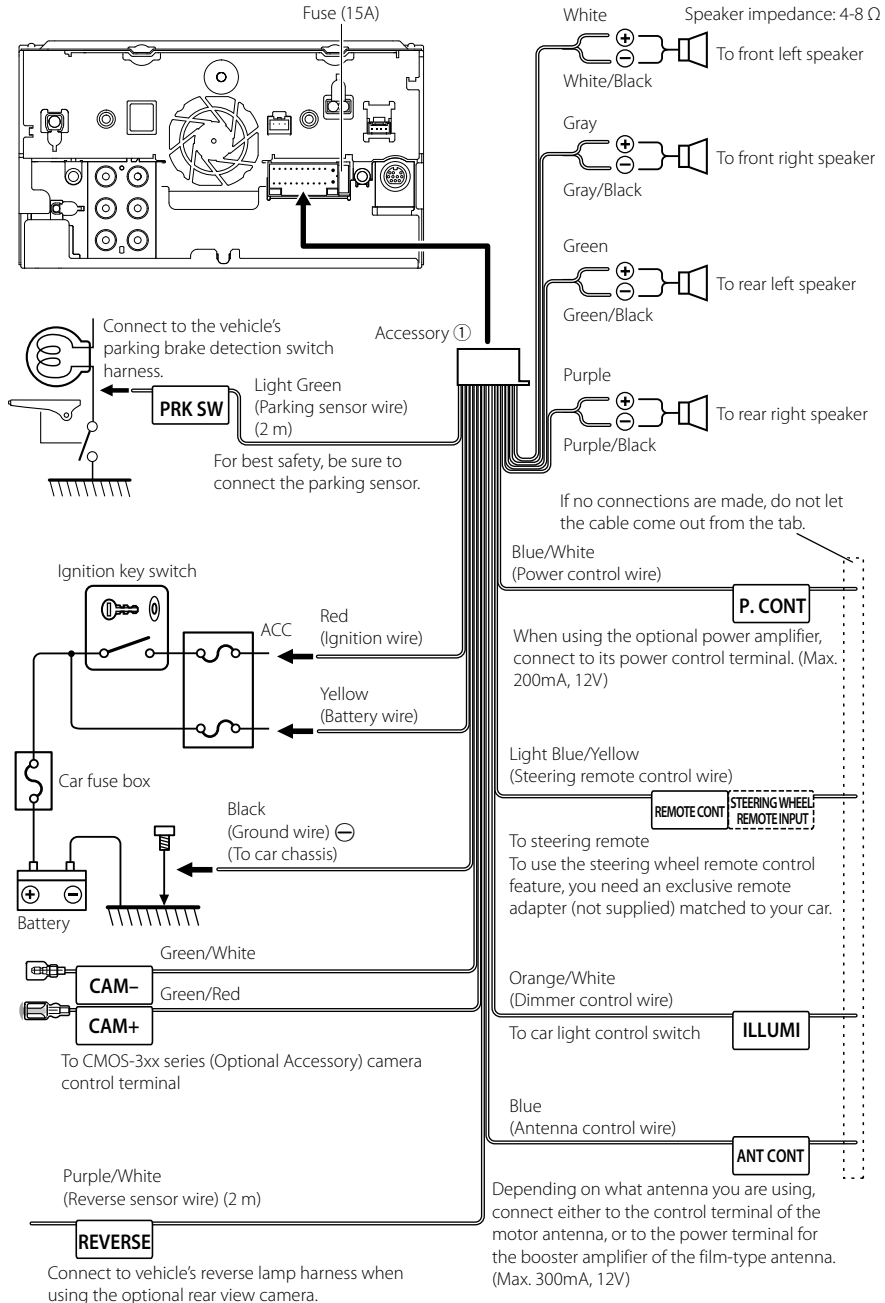



## Connecting the system and external components

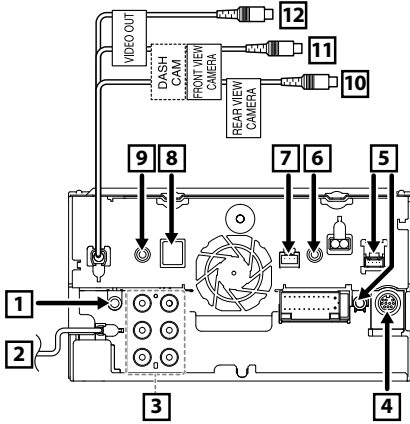

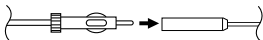
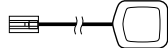
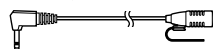
<b>1</b>	AV Audio output (ø3.5 mini jack)
<b>2</b>	FM/AM antenna input 
<b>3</b>	When connecting to an external amplifier, connect its ground wire to the car's chassis to avoid damaging the unit.  <div style="display: flex; flex-direction: column; align-items: flex-start;"> <div style="display: flex; align-items: center; margin-bottom: 5px;"> <span style="font-size: 1em;">⊖</span> Rear Audio Preout (Left; White, Right; Red)         </div> <div style="display: flex; align-items: center; margin-bottom: 5px;"> <span style="font-size: 1em;">⊖</span> Front Audio Preout (Left; White, Right; Red)         </div> <div style="display: flex; align-items: center;"> <span style="font-size: 1em;">⊖</span> Subwoofer Preout (Left; White, Right; Red)         </div> </div>
<b>4</b>	SiriusXM Connect Vehicle Tuner connector
<b>5</b>	iDatalink connector
<b>6</b>	AV-IN (CA-C3AV; Optional Accessory) input
<b>7</b>	Dashboard camera interface Connect a Dashboard Camera DRV-N520 (optional accessory). <b>(P.90)</b>
<b>8</b>	Accessory ⑨: GPS Antenna 
<b>9</b>	Accessory ④: Bluetooth Microphone 
<b>10</b>	Rear view camera input (Yellow)

<b>11</b>	Front view camera/ Dashboard camera input (Yellow)
<b>12</b>	Visual Output (Yellow)

## Connecting a USB device

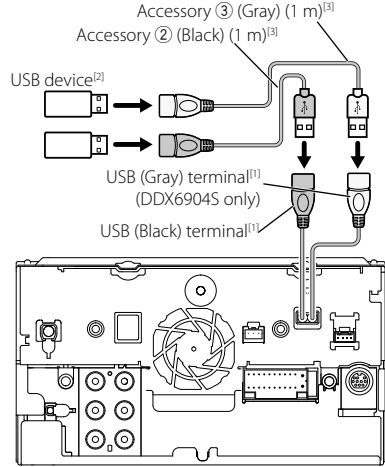

<sup>[1]</sup> USB maximum power supply current :  
DC 5 V  $\pm$  1.5 A

<sup>[2]</sup> Sold separately / Use CA-U1EX to extend the cable if necessary. (Max 500 mA, 5V)

<sup>[3]</sup> See **Securing the USB extension cable (P.89)**.

## Securing the USB extension cable

Secure the USB extension cable with insulating tape or the like so that its connectors are not disconnected.

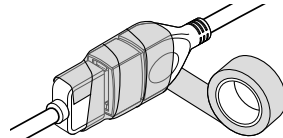

## Connecting an iPod/iPhone

### Lightning connector

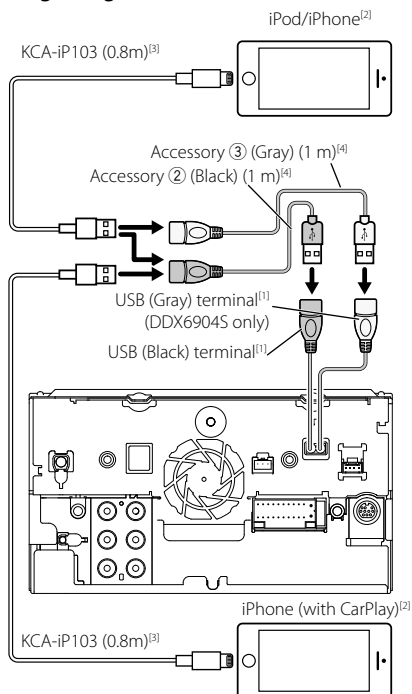

<sup>[1]</sup> USB maximum power supply current :  
DC 5 V  $\equiv$  1.5 A

<sup>[2]</sup> Sold separately

<sup>[3]</sup> Optional accessory

<sup>[4]</sup> See **Securing the USB extension cable (P.89)**.

## Connecting an Android smartphone

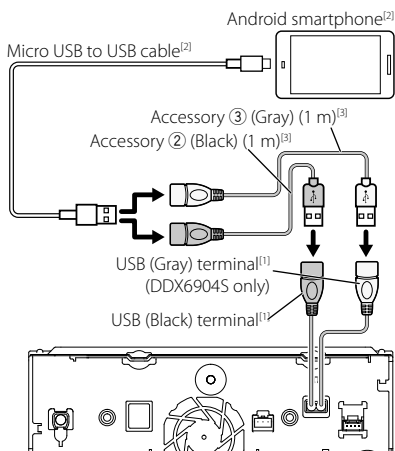

<sup>[1]</sup> USB maximum power supply current :  
DC 5 V  $\equiv$  1.5 A

<sup>[2]</sup> Sold separately

<sup>[3]</sup> See **Securing the USB extension cable (P.89)**.

## Connecting a Dashboard camera

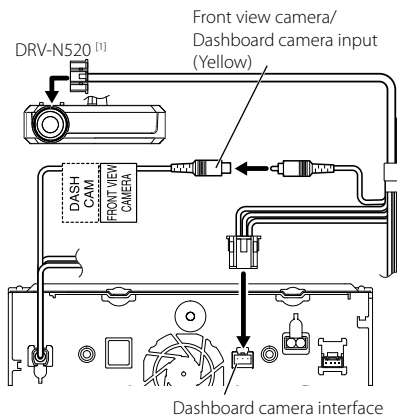

<sup>[1]</sup> Optional accessory

# Troubleshooting

## Problems and Solutions

If any trouble occurs, first check the following table for possible problems.

### NOTE

- Some functions of this unit may be disabled by some settings made on this unit.
- What might seem to be a malfunction in your unit may just be the result of slight misoperation or miswiring.

### About settings

- **Cannot set up the subwoofer.**
- **Cannot set up subwoofer phase.**
- **No output from the subwoofer.**
- **Cannot set up the low pass filter.**
- **Cannot set up the high pass filter.**

Subwoofer is not set to on.

- Set the subwoofer to on. See *Speaker/X'over setup (P.72)*.

The dual zone function is enabled.

- Set the dual zone function to off. See *Zone Control (P.75)*.

- **Cannot select the output destination of the subsource in the dual zone.**
- **Cannot adjust the volume of the rear speakers.**

The dual zone function is disabled.

- Set the dual zone function to on. See *Zone Control (P.75)*.

- **Cannot set up the equalizer.**
- **Cannot set up the crossover network.**

The dual zone function is enabled.

- Set the dual zone function to off. See *Zone Control (P.75)*.

### About audio operations

#### Radio reception is poor.

The car antenna is not extended.

- Pull out the antenna all the way.
- The antenna control wire is not connected.
- Connect the wire correctly. See *Connecting the system and external components (P.89)*.

#### Cannot select a folder.

The random play function is enabled.

- Turn off the random function.

#### Cannot perform repeat play during VCD playback.

The PBC function is enabled.

- Turn off the PBC function.

#### The specified disc does not play, but another one plays instead.

The disc is quite dirty.

- Clean the disc. See *Precautions on handling discs (P.4)*.

The disc is severely scratched.

- Try another disc instead.

#### The sound skips when an audio file is being played.

The disc is scratched or dirty.

- Clean the disc. See *Precautions on handling discs (P.4)*.

The recording condition is bad.

- Record the file again or use another disc.

### Other

#### The Touch Sensor Tone doesn't sound.

The preout jack is being used.

- The Touch Sensor Tone cannot be output from the preout jack.

#### Android smartphone operation is slow.

This occurs when multiple applications are started on the Android smartphone.

- For details, see *Caution for Smartphone Users (P.5)*.

## Error Messages

When you fail to operate the unit correctly, the cause of the failure appears as the message on the screen.

#### here is an error in the speaker wiring. Please check the connections.

Protective circuit has been activated because a speaker cord has shorted or it has come in contact with the car chassis.

- Wire or insulate the speaker cord as appropriate and turn the power off and on again.

#### Hot Error

When the internal temperature of this unit rises to 60°C or more, the protection circuit is activated and you may not be able to operate the unit.

- Use the unit again after reducing the temperature of the unit.

#### Mecha Error

The disc player is malfunctioning.

- Eject the disc and try inserting it again. Contact the KENWOOD dealer if this indicator continues blinking or the disc cannot be ejected.

## Troubleshooting

---

### Disc Error

An unplayable disc is inserted.

- Change the disc. See **Playable Media and Files (P.93)**.

---

### Read Error

The disc is quite dirty.

- Clean the disc. See **Precautions on handling discs (P.4)**.

Disc is upside down.

- Load the disc with the labeled side up.

---

### Region Code Error

The disc you wanted to play has a region code that cannot be played with this unit.

- See **Region Codes in the World (P.95)** or try another disc.

---

### Error 07–67

The unit is not operating correctly due to some reason or other.

- Turn the power off and on again. If the “Error 07–67” message does not disappear, see your nearest KENWOOD dealer.

---

### No Device (USB device)

The USB device is selected as a source although no USB device is connected.

- Change the source to any source other than USB/iPod. Connect a USB device, and change the source to USB again.

---

### Disconnected (iPod, Bluetooth audio player)

The iPod/Bluetooth audio player is selected as a source although no iPod/Bluetooth audio player is connected.

- Change the source to any source other than iPod/Bluetooth. Connect an iPod/Bluetooth audio player, and change the source to iPod/Bluetooth again.

---

### No Media file

The connected USB device contains no playable audio file. Media was played that doesn't have data recorded that the unit can play.

- See **Playable Media and Files (P.93)** and try another USB device.

---

### USB device over current status detected.

The connected USB device is rated a current capacity higher than the allowable limit.

- Check the USB device. Some trouble may have occurred to the connected USB device.
- Change the source to any source other than USB. Remove the USB device.

---

## SiriusXM

---

### Check Tuner

A SiriusXM tuner is not connected to this unit.

- Verify that the SiriusXM Connect Vehicle Tuner cable is securely connected to the radio.

---

### Subscription Updated - Press Return To Continue

The SiriusXM subscription has been renewed.

- Pressing the Control knob will clear the message.

---

### SXM Chan Unavailable

The currently selected channel is unavailable.

- —

---

### SXM Ch Unsubscribed

The currently selected channel is not subscribed to.

- —

---

### SXM Check Antenna

No antenna is connected to the SiriusXM tuner.

- Check that an antenna is connected to the SiriusXM tuner. Check antenna for damages.

---

### SXM No Signal

No SiriusXM radio signal is received.

- Verify that your vehicle is outdoors with a clear view of the sky.

---

### Channel Locked

The selected channel has been locked by the parental controls.

- Enter the unlock code when you are asked. See **Parental Control (P.49)**.

---

### Incorrect Pass Code entered

The selected channel is a mature or parental lock channel, and locked by the parental lock or user lock code.

- Enter the correct lock code.

# Appendix

## Playable Media and Files

You can play various kinds of media and files on this unit.

### List of playable discs

Disc types / Standard		Support	Remark
DVD	DVD Video	○	
	DVD Audio	×	
	DVD-VR	×	
	DVD-R*1	○	<ul style="list-style-type: none"> <li>• MP3/ WMA/ AAC/ WAV/ FLAC/ Vorbis/ MPEG1/ MPEG2/ MPEG4/ H.264/ WMV/ MKV playback</li> <li>• Multi-border/Multisession playback (Playback depends on authoring conditions)</li> </ul>
	DVD-RW	○	
	DVD+R	○	
	DVD+RW	○	
	DVD-R DL (Dual layer)	○	Only video format
DVD+R DL (Double layer)	○		
DVD-RAM	×		
CD	Music CD*1	○	
	CD-ROM	○	<ul style="list-style-type: none"> <li>• MP3/ WMA/ AAC/ WAV/ FLAC/ Vorbis playback</li> </ul>
	CD-R	○	<ul style="list-style-type: none"> <li>• Multisession is supported.</li> </ul>
	CD-RW	○	<ul style="list-style-type: none"> <li>• Packet write is not supported.</li> </ul>
	DTS-CD	×	
	Video CD (VCD)	○	
	Super video CD	×	
	Photo CD	×	
	CD-EXTRA	△	Only music CD session can be played.
	HDCD	△	Normal music CD sound quality
	CCCD	×	
Others	Dualdisc	×	
	Super audio CD	△	Only CD layer can be played.

○ : Playback is possible.

△ : Playback is partly possible.

×

\*1 Incompatible with 8 cm (3 inch) discs.

### Use of DualDisc

When playing a "DualDisc" on this unit, the surface of the disc that is not played may be scratched while the disc is inserted or ejected. Since the music CD surface does not conform to the CD standard, playback may be impossible.

(A "DualDisc" is a disc with one surface containing DVD standard signals and the other surface containing music CD signals.)

### About disc format

The disc format should be the one of the following.

- ISO 9660 Level 1/2
- Joliet
- Romeo
- Long file name

## About files

The following audio, video, and picture files are supported.

### Playable Audio files

	Format	Bit rate	Sampling frequency	Bit count
AAC-LC (.m4a)	MPEG2/4 AAC LC HE-AAC(V1,V2)	8 – 320kbps, VBR	16 – 48 kHz	16 bit
MP3 (.mp3)	MPEG 1/2 Audio Layer 3	8 – 320kbps, VBR	16 – 48 kHz	16 bit
WMA (.wma)	Windows Media Audio Standard L3 profile (Version 7,8,9)	8 – 320kbps	16 – 48 kHz	16 bit
Linear PCM (WAVE) (.wav)	RIFF waveform Audio Format	–	16 – 48 kHz (Disc), 16 – 192 kHz (USB)	16/ 24 bit
FLAC (.flac)	flac	–	16 – 48 kHz (Disc), 16 – 192 kHz (USB)	16/ 24 bit
Vorbis (.ogg)	vorbis	VBR	16 – 48 kHz	16 bit
DSD (.dsf, .dff)	DSF, DSDIFF	–	2.8 MHz, 5.6 MHz, 11.2 MHz	1 bit

- If music of normal CD and other playback systems are recorded in the same disc, only the playback system recorded at the first setout is played.
- WMA and AAC of which is covered with DRM cannot be played.
- DSD sound is converted to PCM sound before playback.
- The EmChinks tag of DSDIFF is not supported.
- Although the audio files are complied with the standards listed above, the play may be impossible depending on the types or conditions of media or device.
- This unit supports playback of High-Resolution Audio files.  
It is recommended that a car audio system should be configured with all High-Resolution Audio compatible products from player to speaker to enjoy its high quality sound.

### Acceptable Video files

	Profile	Max. Picture size	Max. bit rate	Audio format
MPEG-1 (.mpg, .mpeg)	–	352 × 240, 352 × 288	1.5 Mbps	MPEG Audio Layer 2
MPEG-2 (.mpg, .mpeg)	MP@ML	720 × 480, 720 × 576	8 Mbps	MPEG Audio Layer 2
H.264/MPEG-4 AVC (.mp4, .m4v, .avi, .flv, .f4v)	Baseline Profile, Main Profile	1920 × 1080 (30 fps)	8 Mbps	MP3, AAC
MPEG-4 (.mp4, .avi)	Advanced Simple Profile	1920 × 1080 (30 fps)	8 Mbps	MP3, AAC
WMV (.wmv)	Main Profile	1920 × 1080 (30 fps)	8 Mbps	WMA
MKV (.mkv)	Video Format follows H.264/MPEG-4 AVC, MPEG-4, WMV			MP3, AAC, WMA, Vorbis, FLAC

- This unit can only play back files which are less than 4 GB.

### Limitation of structure for the file and the folder

	Disc media	USB device
Maximum number of folder layers	8	8
Maximum number of files (per folder)	999	999
Maximum number of folders (per folder)	5000	9999
Maximum number of folders (per device)	5000	Unlimited

- You can enter a folder name and file name with 255 or fewer single-byte characters.
- Files in the folder whose folder name begins with a dot (.) cannot be played.

## Region Codes in the World

The DVD players are given a region code according to the country or area it is marketed, as shown in the following map.

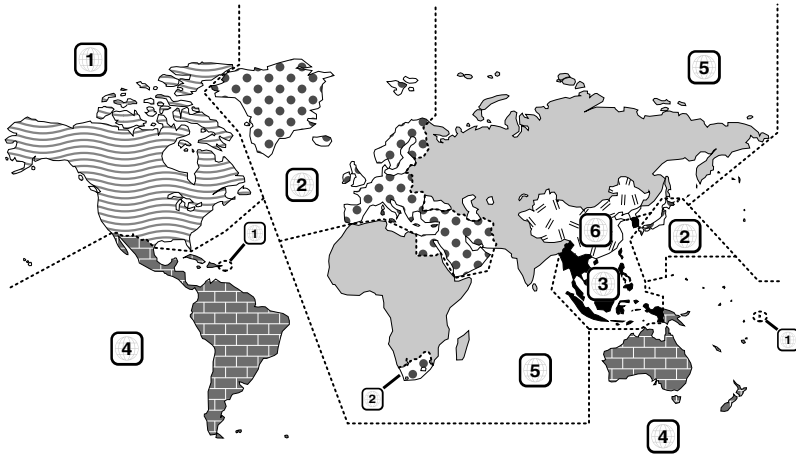

### ■ DVD disc marks



Indicates a region number. The discs with this mark can be played with any DVD player.



Indicates the number of audio languages recorded. Up to 8 languages can be recorded in a movie. You can select a favorite language.



Indicates the number of subtitled languages recorded. Up to 32 languages can be recorded.



If a DVD disc has scenes shot from multiple angles, you can select a favorite angle.

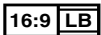

Indicates the type of screen for the image. The left mark indicates that a wide image picture (16:9) is displayed on a standard TV set screen (4:3) with a black band at both the top and bottom of the screen (letter box).

### ■ Operation regulatory marks

With this DVD, some functions of this unit such as the play function may be restricted depending on the location where the DVD is playing. In this case, the following marks will appear on the screen. For more information, refer to the disc manual.



### ■ Discs with limited period of use

Do not leave discs with a limited period of use in this unit. If you load an already expired disc, you may not be able to remove it from this unit.

## DVD Language Codes

Code	Language
aa	Afar
ab	Abkhazian
af	Afrikaans
am	Amharic
ar	Arabic
as	Assamese
ay	Aymara
az	Azerbaijani
ba	Bashkir
be	Byelorussian
bg	Bulgarian
bh	Bihari
bi	Bislama
bn	Bengali, Bangla
bo	Tibetan
br	Breton
ca	Catalan
co	Corsican
cs	Czech
cy	Welsh
da	Danish
de	German
dz	Bhutani
el	Greek
en	English
eo	Esperanto
es	Spanish
et	Estonian
eu	Basque
fa	Persian
fi	Finnish
fj	Fiji
fo	Faroese
fr	French
fy	Frisian
ga	Irish
gd	Scots Gaelic
gl	Galician
gn	Guarani
gu	Gujarati
ha	Hausa
he	Hebrew
hi	Hindi
hr	Croatian
hu	Hungarian
hy	Armenian

Code	Language
ia	Interlingua
ie	Interlingue
ik	Inupiak
id	Indonesian
is	Icelandic
it	Italian
ja	Japanese
jv	Javanese
ka	Georgian
kk	Kazakh
kl	Greenlandic
km	Cambodian
kn	Kannada
ko	Korean
ks	Kashmiri
ku	Kurdish
ky	Kirghiz
la	Latin
lb	Luxembourgish
ln	Lingala
lo	Laotian
lt	Lithuanian
lv	Latvian, Lettish
mg	Malagasy
mi	Maori
mk	Macedonian
ml	Malayalam
mn	Mongolian
mo	Moldavian
mr	Marathi
ms	Malay
mt	Maltese
my	Burmese
na	Nauru
ne	Nepali
nl	Dutch
no	Norwegian
oc	Occitan
om	(Afan) Oromo
or	Oriya
pa	Punjabi
pl	Polish
ps	Pashto, Pushto
pt	Portuguese
qu	Quechua
rm	Rhaeto-Romance

Code	Language
rn	Kirundi
ro	Romanian
ru	Russian
rw	Kinyarwanda
sa	Sanskrit
sd	Sindhi
sg	Sangho
sh	Serbo-Croatian
si	Singhalese
sk	Slovak
sl	Slovenian
sm	Samoan
sn	Shona
so	Somali
sq	Albanian
sr	Serbian
ss	Siswati
st	Sesotho
su	Sundanese
sv	Swedish
sw	Swahili
ta	Tamil
te	Telugu
tg	Tajik
th	Thai
ti	Tigrinya
tk	Turkmen
tl	Tagalog
tn	Setswana
to	Tongan
tr	Turkish
ts	Tsonga
tt	Tatar
tw	Twi
uk	Ukrainian
ur	Urdu
uz	Uzbek
vi	Vietnamese
vo	Volapuk
wo	Wolof
xh	Xhosa
yo	Yoruba
zh	Chinese
zu	Zulu



## Specifications

### ■ Monitor section

#### Picture Size

- : 6.75 inches (diagonal) wide
- : 151.8 mm (W) × 79.68 mm (H)
- 5-31/32 × 3-1/8 inch

#### Display System

- : TN LCD panel

#### Drive System

- : TFT active matrix system

#### Number of Pixels

- : 1,152,000 (800H x 480V x RGB)

#### Effective Pixels

- : 99.99 %

#### Pixel Arrangement

- : RGB striped arrangement

#### Back Lighting

- : LED

### ■ DVD player section

#### D/A Converter

- : 24/ 32 bit

#### Audio Decoder

- : Linear PCM/ Dolby Audio/ MP3/ WMA/ AAC/ WAV/ FLAC/ Vorbis

#### Video Decoder

- : MPEG1/ MPEG2/ MPEG4/ WMV/ H.264/ MKV

#### Wow & Flutter

- : Below Measurable Limit

#### Frequency Response

- 96 kHz : 20 – 44,000 Hz
- 48 kHz : 20 – 22,000 Hz
- 44.1 kHz : 20 – 20,000 Hz

#### Total Harmonic Distortion

- : 0.010 % (1 kHz)

#### S/N Ratio (dB)

- : 90 dB

#### Dynamic Range

- : 89 dB

#### Disc Format

- : DVD-Video/ VIDEO-CD/ CD-DA

#### Quantifying Bit Number

- : 16/ 20/ 24 bit

### ■ USB interface section



#### USB Standard

- : USB 2.0 High Speed

#### File System

- : FAT 16/ 32, exFAT, NTFS

#### Maximum Power Supply Current

- DDX6904S : DC 5 V  1.5 A × 2
- DDX6704S : DC 5 V  1.5 A

#### D/A Converter

- : 24/ 32 bit

#### Audio Decoder

- : MP3/ WMA/ AAC/ WAV/ FLAC/ Vorbis/ DSD

#### Video Decoder

- : MPEG1/ MPEG2/ MPEG4/ WMV/ H.264/ MKV

### ■ Bluetooth section

#### Technology

- : Bluetooth Ver.3.0

#### Frequency

- : 2.402 – 2.480 GHz

#### Output Power

- : +4dBm (MAX), 0dBm (AVE), Power Class2

#### Maximum Communication range

- : Line of sight approx. 10m (32.8 ft)

#### Audio Codec

- : SBC/ AAC

#### Profile (Multi Profile support)

- HFP (V1.6) (Hands Free Profile)
- SPP (Serial Port Profile)
- A2DP (Advanced Audio Distribution Profile)
- AVRCP (V1.5) (Audio/Video Remote Control Profile)
- PBAP (Phonebook Access Profile)

## Appendix

### ■ DSP section

#### Graphics equalizer

Band: 13 Band

Frequency (BAND1 – 13)

: 62.5/ 100/ 160/ 250/ 400/ 630/ 1k/ 1.6k/ 2.5k/ 4k/  
6.3k/ 10k/ 16k Hz

#### Gain

: -9/-8/-7/-6/-5/-4/-3/-2/-1/0/1/2/3/4/5/6/7/8/9 dB

#### 2Way X'Over

##### High pass filter

Frequency: Through, 30/ 40/ 50/ 60/ 70/ 80/ 90/ 100/  
120/ 150/ 180/ 220/ 250 Hz

Slope: -6/-12/-18/-24 dB/Oct.

##### Low pass filter

Frequency: 30/ 40/ 50/ 60/ 70/ 80/ 90/ 100/ 120/  
150/ 180/ 220/ 250 Hz, Through

Slope: -6/-12/-18/-24 dB/Oct.

#### Position

Front / Rear /Subwoofer Delay

: 0 – 20.01 ft (0.03 or 0.04 ft Step)

#### Gain

: -8 – 0 dB

#### Subwoofer level

: -50 – +10 dB

### ■ Digital FM tuner section

#### Frequency Range (step)

: 87.9 MHz – 107.9 MHz (200 kHz)

#### Frequency Response ( $\pm 3.0$ dB)

: 20 Hz – 20 kHz

#### S/N Ratio

: 80 dB (STEREO)

### ■ Digital AM tuner section

#### Frequency Range (step)

: 530 kHz – 1700 kHz (10 kHz)

#### Frequency Response ( $\pm 3.0$ dB)

: 40 Hz – 15 kHz

#### S/N Ratio (dB)

: 80 dB (STEREO)

### ■ FM tuner section

#### Frequency Range (step)

: 87.9 MHz – 107.9 MHz (200 kHz)

#### Usable Sensitivity (S/N : 30 dB)

: 9.3 dBf (0.8  $\mu$ V/ 75  $\Omega$ )

#### Quieting Sensitivity (S/N : 50 dB)

: 10.2 dBf (1.13  $\mu$ V/ 75  $\Omega$ )

#### Frequency Response

: 30 Hz – 15 kHz

#### S/N Ratio (dB)

: 75 dB (MONO)

#### Selectivity ( $\pm 400$ kHz)

: Over 80 dB

#### Stereo Separation

: 45 dB (1 kHz)

### ■ AM tuner section

#### Frequency Range (step)

: 530 kHz – 1700 kHz (10 kHz)

#### Usable Sensitivity

: 28 dB $\mu$

### ■ Video section

#### Color System of External Video Input

: NTSC

#### External Video Input Level (mini jack)

: 1 V<sub>p-p</sub>/ 75  $\Omega$

#### External Audio Max Input Level (mini jack)

: 2 V/ 25 k $\Omega$

#### Video Input Level (RCA jacks)

: 1 V<sub>p-p</sub>/ 75  $\Omega$

#### Video Output Level (RCA jacks)

: 1 V<sub>p-p</sub>/ 75  $\Omega$

#### Audio Output Level (mini jack)

: 1.2 V/ 10 k $\Omega$

## ■ Audio section

### Maximum Power (Front & Rear)

: 50 W × 4

### Typical Power Output (Front & Rear)

Full Bandwidth Power (at less than 1% THD)

: 22 W × 4

### Output frequency band

: 20 – 88,000 Hz

### Preout Level (V)

DDX6904S

: 5 V / 10 kΩ

DDX6704S

: 4 V / 10 kΩ

### Preout Impedance

: ≤ 300 Ω

### Speaker Impedance

: 4 – 8 Ω

## ■ General

### Operating Voltage

: 14.4 V (10.5 – 16 V allowable)

### Maximum Current Consumption

: 15 A

### Installation Dimensions (W × H × D)

: 178 × 100 × 155 mm

7 × 3-15/16 × 6-1/8 inch

With Sleeve (DDX6904S)

: 182 × 112 × 153 mm

7-3/16 × 4-7/16 × 6 inch

### Operational Temperature Range

: -10 °C – +60 °C

### Weight

DDX6904S

: 2.3 kg (5.0 lbs)

DDX6704S

: 2.0 kg (4.5 lbs)

### NOTE

- Although the effective pixels for the liquid crystal panel is given as 99.99% or more, 0.01% of pixels may not light or may light incorrectly.

**Specifications subject to change without notice.**

## About this Unit

### ■ Copyrights

- The Bluetooth® word mark and logos are registered trademarks owned by Bluetooth SIG, Inc. and any use of such marks by JVC KENWOOD Corporation is under license. Other trademarks and trade names are those of their respective owners.
- Manufactured under license from Dolby Laboratories. Dolby, Dolby Audio and the double-D symbol are trademarks of Dolby Laboratories.
-  is a trademark of DVD Format/Logo Licensing Corporation registered in the U.S., Japan and other countries.
- This item incorporates copy protection technology that is protected by U.S. patents and other intellectual property rights of Rovi Corporation. Reverse engineering and disassembly are prohibited.
- Microsoft and Windows Media are either registered trademarks or trademarks of Microsoft Corporation in the United States and/or other countries.
- This software is based in part on the work of the independent JPEG Group.
- The "AAC" logo is a trademark of Dolby Laboratories.
- "Made for iPod" and "Made for iPhone" mean that an electronic accessory has been designed to connect specifically to iPod, or iPhone, respectively, and has been certified by the developer to meet Apple performance standards. Apple is not responsible for the operation of this device or its compliance with safety and regulatory standards. Please note that the use of this accessory with iPod, or iPhone may affect wireless performance.
- iPhone, iPod, and iPod touch are trademarks of Apple Inc., registered in the U.S. and other countries.
- Apple, Siri, Apple CarPlay and Apple CarPlay logo are trademarks of Apple Inc., registered in the U.S. and other countries. Lightning is a trademark of Apple Inc.
- Sirius, XM and all related marks and logos are trademarks of Sirius XM Radio Inc. All rights reserved.
- HD Radio Technology manufactured under license from iBiquity Digital Corporation. U.S. and Foreign Patents. HD Radio™ and the HD, HD Radio, and "Arc" logos are proprietary trademarks of iBiquity Digital Corp.
- INRIX is a registered trademark of INRIX, Inc.
- PANDORA, the PANDORA logo, and the Pandora trade dress are trademarks or registered trademarks of Pandora Media, Inc., used with permission.
- SPOTIFY and the Spotify logo are among the registered trademarks of Spotify AB.
- Android, Android Auto, Google Play and other marks are trademarks of Google Inc.
- BlackBerry®, RIM®, Research In Motion® and related trademarks, names and logos are the property of

## Appendix

Research In Motion Limited and are registered and/ or used in the U.S. and countries around the world. Used under license from Research In Motion Limited.

- This product includes FontAvenue® fonts licenced by NEC Corporation. FontAvenue is a registered trademark of NEC Corporation.



**FontAvenue**

- This product includes "Ubiquitous QuickBoot™" technology developed by Ubiquitous Corp. Ubiquitous QuickBoot™ is a trademark of Ubiquitous Corp. Copyright© 2017 Ubiquitous Corp. All rights reserved.



Ubiquitous

- THIS PRODUCT IS LICENSED UNDER THE AVC PATENT PORTFOLIO LICENSE FOR THE PERSONAL USE OF A CONSUMER OR OTHER USES IN WHICH IT DOES NOT RECEIVE REMUNERATION TO (i) ENCODE VIDEO IN COMPLIANCE WITH THE AVC STANDARD ("AVC VIDEO") AND/OR (ii) DECODE AVC VIDEO THAT WAS ENCODED BY A CONSUMER ENGAGED IN A PERSONAL ACTIVITY AND/OR WAS OBTAINED FROM A VIDEO PROVIDER LICENSED TO PROVIDE AVC VIDEO. NO LICENSE IS GRANTED OR SHALL BE IMPLIED FOR ANY OTHER USE. ADDITIONAL INFORMATION MAY BE OBTAINED FROM MPEG LA, L.L.C. SEE [HTTP://WWW.MPEGLA.COM](http://www.mpegla.com)
- THIS PRODUCT IS LICENSED UNDER THE MPEG-4 VISUAL PATENT PORTFOLIO LICENSE FOR THE PERSONAL AND NON-COMMERCIAL USE OF A CONSUMER FOR (i) ENCODING VIDEO IN COMPLIANCE WITH THE MPEG-4 VISUAL STANDARD ("MPEG-4 VIDEO") AND/OR (ii) DECODING MPEG-4 VIDEO THAT WAS ENCODED BY A CONSUMER ENGAGED IN A PERSONAL AND NON-COMMERCIAL ACTIVITY AND/OR WAS OBTAINED FROM A VIDEO PROVIDER LICENSED BY MPEG LA TO PROVIDE MPEG-4 VIDEO. NO LICENSE IS GRANTED OR SHALL BE IMPLIED FOR ANY OTHER USE. ADDITIONAL INFORMATION INCLUDING THAT RELATING TO PROMOTIONAL, INTERNAL AND COMMERCIAL USES AND LICENSING MAY BE OBTAINED FROM MPEG LA, LLC. SEE [HTTP://WWW.MPEGLA.COM](http://www.mpegla.com).
- THIS PRODUCT IS LICENSED UNDER THE VC-1 PATENT PORTFOLIO LICENSE FOR THE PERSONAL AND NON-COMMERCIAL USE OF A CONSUMER TO (i) ENCODE VIDEO IN COMPLIANCE WITH THE VC-1 STANDARD ("VC-1 VIDEO") AND/OR (ii) DECODE VC-1 VIDEO THAT WAS ENCODED BY A CONSUMER ENGAGED IN A PERSONAL AND NON-COMMERCIAL ACTIVITY AND/OR WAS OBTAINED FROM A VIDEO PROVIDER LICENSED TO PROVIDE VC-1 VIDEO. NO LICENSE IS GRANTED OR SHALL BE IMPLIED FOR ANY OTHER USE. ADDITIONAL INFORMATION MAY BE OBTAINED FROM MPEG LA, L.L.C. SEE [HTTP://WWW.MPEGLA.COM](http://www.mpegla.com)

- libFLAC

Copyright (C) 2000-2009 Josh Coalson

Copyright (C) 2011-2013 Xiph.Org Foundation

Redistribution and use in source and binary forms, with or without modification, are permitted provided that the following conditions are met:

- Redistributions of source code must retain the above copyright notice, this list of conditions and the following disclaimer.
- Redistributions in binary form must reproduce the above copyright notice, this list of conditions and the following disclaimer in the documentation and/or other materials provided with the distribution.
- Neither the name of the Xiph.org Foundation nor the names of its contributors may be used to endorse or promote products derived from this software without specific prior written permission.

THIS SOFTWARE IS PROVIDED BY THE COPYRIGHT HOLDERS AND CONTRIBUTORS "AS IS" AND ANY EXPRESS OR IMPLIED WARRANTIES, INCLUDING, BUT NOT LIMITED TO, THE IMPLIED WARRANTIES OF MERCHANTABILITY AND FITNESS FOR A PARTICULAR PURPOSE ARE DISCLAIMED. IN NO EVENT SHALL THE FOUNDATION OR CONTRIBUTORS BE LIABLE FOR ANY DIRECT, INDIRECT, INCIDENTAL, SPECIAL, EXEMPLARY, OR CONSEQUENTIAL DAMAGES (INCLUDING, BUT NOT LIMITED TO, PROCUREMENT OF SUBSTITUTE GOODS OR SERVICES; LOSS OF USE, DATA, OR PROFITS; OR BUSINESS INTERRUPTION) HOWEVER CAUSED AND ON ANY THEORY OF LIABILITY, WHETHER IN CONTRACT, STRICT LIABILITY, OR TORT (INCLUDING NEGLIGENCE OR OTHERWISE) ARISING IN ANY WAY OUT OF THE USE OF THIS SOFTWARE, EVEN IF ADVISED OF THE POSSIBILITY OF SUCH DAMAGE.

- libvorbis

Copyright (c) 2002-2008 Xiph.org Foundation

Redistribution and use in source and binary forms, with or without modification, are permitted provided that the following conditions are met:

- Redistributions of source code must retain the above copyright notice, this list of conditions and the following disclaimer.
- Redistributions in binary form must reproduce the above copyright notice, this list of conditions and the following disclaimer in the documentation and/or other materials provided with the distribution.
- Neither the name of the Xiph.org Foundation nor the names of its contributors may be used to endorse or promote products derived from this software without specific prior written permission.

THIS SOFTWARE IS PROVIDED BY THE COPYRIGHT HOLDERS AND CONTRIBUTORS "AS IS" AND ANY EXPRESS OR IMPLIED WARRANTIES, INCLUDING, BUT NOT LIMITED TO, THE IMPLIED WARRANTIES OF MERCHANTABILITY AND FITNESS FOR A PARTICULAR PURPOSE ARE DISCLAIMED. IN NO EVENT SHALL THE FOUNDATION OR CONTRIBUTORS BE LIABLE FOR ANY

DIRECT, INDIRECT, INCIDENTAL, SPECIAL, EXEMPLARY, OR CONSEQUENTIAL DAMAGES (INCLUDING, BUT NOT LIMITED TO, PROCUREMENT OF SUBSTITUTE GOODS OR SERVICES; LOSS OF USE, DATA, OR PROFITS; OR BUSINESS INTERRUPTION) HOWEVER CAUSED AND ON ANY THEORY OF LIABILITY, WHETHER IN CONTRACT, STRICT LIABILITY, OR TORT (INCLUDING NEGLIGENCE OR OTHERWISE) ARISING IN ANY WAY OUT OF THE USE OF THIS SOFTWARE, EVEN IF ADVISED OF THE POSSIBILITY OF SUCH DAMAGE.

- libogg

Copyright (c) 2002, Xiph.org Foundation  
Redistribution and use in source and binary forms, with or without modification, are permitted provided that the following conditions are met:

- Redistributions of source code must retain the above copyright notice, this list of conditions and the following disclaimer.
- Redistributions in binary form must reproduce the above copyright notice, this list of conditions and the following disclaimer in the documentation and/or other materials provided with the distribution.
- Neither the name of the Xiph.org Foundation nor the names of its contributors may be used to endorse or promote products derived from this software without specific prior written permission.

THIS SOFTWARE IS PROVIDED BY THE COPYRIGHT HOLDERS AND CONTRIBUTORS "AS IS" AND ANY EXPRESS OR IMPLIED WARRANTIES, INCLUDING, BUT NOT LIMITED TO, THE IMPLIED WARRANTIES OF MERCHANTABILITY AND FITNESS FOR A PARTICULAR PURPOSE ARE DISCLAIMED. IN NO EVENT SHALL THE FOUNDATION OR CONTRIBUTORS BE LIABLE FOR ANY DIRECT, INDIRECT, INCIDENTAL, SPECIAL, EXEMPLARY, OR CONSEQUENTIAL DAMAGES (INCLUDING, BUT NOT LIMITED TO, PROCUREMENT OF SUBSTITUTE GOODS OR SERVICES; LOSS OF USE, DATA, OR PROFITS; OR BUSINESS INTERRUPTION) HOWEVER CAUSED AND ON ANY THEORY OF LIABILITY, WHETHER IN CONTRACT, STRICT LIABILITY, OR TORT (INCLUDING NEGLIGENCE OR OTHERWISE) ARISING IN ANY WAY OUT OF THE USE OF THIS SOFTWARE, EVEN IF ADVISED OF THE POSSIBILITY OF SUCH DAMAGE.

## ■ FCC WARNING

This equipment may generate or use radio frequency energy. Changes or modifications to this equipment may cause harmful interference unless the modifications are expressly approved in the instruction manual. The user could lose the authority to operate this equipment if an unauthorized change or modification is made.

### NOTE

- This equipment has been tested and found to comply with the limits for a Class B digital device, pursuant to Part 15 of the FCC Rules. These limits are designed to provide reasonable protection against harmful interference in a residential installation.
- This equipment may cause harmful interference to radio communications, if it is not installed and used in accordance with the instructions. However, there is no guarantee that interference will not occur in a particular installation. If this equipment does cause harmful interference to radio or television reception, which can be determined by turning the equipment off and on, the user is encouraged to try to correct the interference by one or more of the following measures:
  - Reorient or relocate the receiving antenna.
  - Increase the separation between the equipment and receiver.
  - Connect the equipment into an outlet on a circuit different from that to which the receiver is connected.
  - Consult the dealer or an experienced radio/TV technician for help.

## ▲ CAUTION

Use of controls or adjustments or performance of procedures other than those specified herein may result in hazardous radiation exposure.

In compliance with Federal Regulations, following are reproductions of labels on, or inside the product relating to laser product safety.

JVC KENWOOD Corporation  
2967-3, ISHIKAWA-MACHI,  
HACHIOJI-SHI, TOKYO, JAPAN

THIS PRODUCT COMPLIES WITH DHHS RULES  
21 CFR SUBCHAPTER J IN EFFECT AT DATE OF  
MANUFACTURE.

Location: Top plate

## Appendix

This transmitter must not be co-located or operated in conjunction with any other antenna or transmitter.

### ■ IC (Industry Canada) Notice

This device complies with Industry Canada licence-exempt RSS standard(s).

Operation is subject to the following two conditions:

- (1) This device may not cause interference, and
- (2) this device must accept any interference, including interference that may cause undesired operation of the device.

### ▲ CAUTION

This equipment complies with FCC/IC radiation exposure limits set forth for an uncontrolled environment and meets the FCC radio frequency (RF) Exposure Guidelines and RSS-102 of the IC radio frequency (RF) Exposure rules. This equipment has very low levels of RF energy that is deemed to comply without maximum permissive exposure evaluation (MPE). But it is desirable that it should be installed and operated keeping the radiator at least 20 cm or more away from person's body.

- Contains Transmitter Module
- FCC ID: ZWY8811X
- Contains Transmitter Module
- IC: 12033A-8811X

### ■ CALIFORNIA, USA

This product contains a CR Coin Cell Lithium Battery which contains Perchlorate Material – special handling may apply.

See [www.dtsc.ca.gov/hazardouswaste/perchlorate](http://www.dtsc.ca.gov/hazardouswaste/perchlorate).

### ■ Información acerca de la eliminación de equipos eléctricos y electrónicos al final de la vida útil (aplicable a los países que hayan adoptado sistemas independientes de recogida de residuos)



Los productos con el símbolo de un contenedor con ruedas tachado no podrán ser desechados como residuos domésticos.

Los equipos eléctricos y electrónicos al final de la vida útil, deberán ser reciclados en instalaciones que puedan dar el tratamiento adecuado a estos productos y a sus subproductos residuales correspondientes. Póngase en contacto con su administración local para obtener información sobre el punto de recogida más cercano. Un tratamiento correcto del reciclaje y la eliminación de residuos ayuda a conservar los recursos y evita al mismo tiempo efectos perjudiciales en la salud y el medio ambiente.

### ■ Informação sobre a eliminação de pilhas

Este produto não deve ser eliminado como lixo doméstico geral. Devolva a pilha usada ao revendedor ou entidade autorizada para que a mesma seja devolvida ao fabricante ou importador.

A reciclagem e a eliminação de lixo de maneira apropriada ajudarão a conservar os recursos naturais ao mesmo tempo que prevenirão os efeitos prejudiciais à nossa saúde e ao meio ambiente.

### ■ Para cumplimiento de la IFT:

“La operación de este equipo esta sujeta a las siguientes dos condiciones:

- (1) es posible que este equipo o dispositivo no cause interferencia perjudicial y
- (2) este equipo o dispositivo debe aceptar cualquier interferencia,

incluyendo la que pueda causar su operación no deseada.”



android  
auto

 Bluetooth®

 Spotify®

(((SiriusXM)))  
READY

 DOLBY AUDIO™

DVD  
VIDEO™

 Designed for  
Windows  
Media™

 pandora®

Made for



iPod



iPhone



Works with

Apple CarPlay

 HD Radio®

This HD Radio receiver enables:

HD2/HD3

Bookmark

Digital Sound

Program Info

Artist Experience

Emergency Alerts

---

# KENWOOD