



Installation Manual: for Jeep Wrangler '07-Current
Wranglers and Gladiators JK, JL and JT #12056-
1101, 12056-1102, 12056-1103

Front Bumper



Mid-width Bumper



Stubby Bumper



Full-width Bumper

⚠ WARNING ⚠

TO REDUCE RISK OF SERIOUS INJURY OR PROPERTY DAMAGE: READ ALL SAFETY MESSAGES AND UNDERSTAND ALL INSTRUCTIONS AND PROCEDURE NOTICES BEFORE ATTEMPTING TO INSTALL OR USE THIS PRODUCT.

⚠ WARNING ⚠

BUMPER NOT INTENDED FOR WINCHES IN EXCESS OF 10,000 LBS. LOAD LIMITS FOR YOUR BUMPER/WINCH MAY BE LESS DEPENDING ON CONDITION OF YOUR VEHICLE AND ATTACHMENTS. FOLLOW ALL INSTRUCTIONS, LIMITATIONS & WARNINGS WITH YOUR VEHICLE, THIS PRODUCT, YOUR WINCH AND SAFE WINCHING PRACTICES SUPPLEMENT.

NOTICE

CHECK STATE AND LOCAL HIGHWAY SAFETY LAWS REGARDING PERMITTED BUMPER TYPES AND HEIGHTS.



A FEW WORDS ABOUT PRODUCT SAFETY:

Your Carnivore Bumpers are intended to enhance the utility and enjoyment of your Jeep vehicle. Before installation, please review the following safety information and installation recommendations. Throughout these instructions important safety information is generally preceded by one of the three signal words indicating the relative risk of injury, property damage or adverse consequence.

The signal words mean:

! WARNING !

A HAZARDOUS SITUATION WHICH, IF NOT AVOIDED, COULD RESULT IN DEATH OR SERIOUS INJURY. YOU CAN BE KILLED OR SERIOUSLY HURT IF YOU DON'T FOLLOW INSTRUCTIONS.

! CAUTION !

A HAZARDOUS SITUATION WHICH, IF NOT AVOIDED, COULD RESULT IN A MINOR OR MODERATE INJURY. YOU CAN BE MODERATELY HURT AND ALSO MAY SUFFER PROPERTY DAMAGE IF YOU DON'T FOLLOW INSTRUCTIONS.

NOTICE

CAREFUL ATTENTION IS REQUIRED TO THIS INSTRUCTION OR OPERATION BUT GENERALLY DOES NOT RELATE TO PERSONAL INJURY. DAMAGE TO YOUR RES-Q PRODUCT OR OTHER PROPERTY MAY RESULT IF YOU DON'T FOLLOW INSTRUCTIONS.

BEFORE YOU BEGIN USAGE:

Congratulations on your purchase of the Carnivore Bumpers. Your top-quality bumper mounts directly to the frame of your Jeep Wrangler or Gladiator. When unpacking, check to make sure all parts are included and not damaged due to shipping. If any part is missing or broken, please call Customer Service at 800-745-6037 as soon as possible. Thank you again for your purchase.

! WARNING !

TO REDUCE RISK OF SERIOUS INJURY OR PROPERTY DAMAGE: READ ALL SAFETY MESSAGES AND UNDERSTAND ALL INSTRUCTIONS AND PROCEDURE NOTICES BEFORE ATTEMPTING TO INSTALL OR USE THIS PRODUCT.

! CAUTION !

WELDED FRONT BUMPERS ARE HEAVY AND WE STRONGLY SUGGEST THE ASSISTANCE OF AN ABLE-BODIED ASSISTANT DURING LIFTING AND INSTALLATION OF YOUR BUMPER.

! CAUTION !

RISK OF EYE INJURY! SAFETY GLASSES MUST BE WORN AT ALL TIMES WHILE INSTALLING OR MAINTAINING THIS PRODUCT. DO NOT USE IF DAMAGED.

! CAUTION !

SHARP EDGES ARE POSSIBLE! GLOVES MUST BE WORN AT ALL TIMES WHILE INSTALLING OR MAINTAINING THIS PRODUCT. DO NOT USE IF DAMAGED.

NOTICE

A SEGMENT OF THE INSTALLATION HAS TO DO WITH ADAPTING THE ORIGINAL EQUIPMENT FOG LIGHTS AND WIRING TO THE NEW BUMPER.

THE PROCEDURE VARIES DEPENDING ON THE MODEL OR THE TRIM LEVEL OF YOUR JL CHASSIS WRANGLER (SPORT VS. SAHARA OR RUBICON).

NOTICE

AS YOU UNPACK YOUR FRONT BUMPER, BE CAREFUL NOT TO SCRATCH THE FINISH WITH A KNIFE OR RAZOR. WE SUGGEST PLACING THE UNPACKED BUMPER BACK INTO THE ORIGINAL BOX SO IT DOES NOT GET SCRATCHED BEFORE THE INSTALLATION BEGINS. THIS BUMPER HAS A CUT-OUT FOR A VEHICLE RECOVERY WINCH. THE BUMPER FEATURES AN INTEGRATED WINCH MOUNTING PLATE.

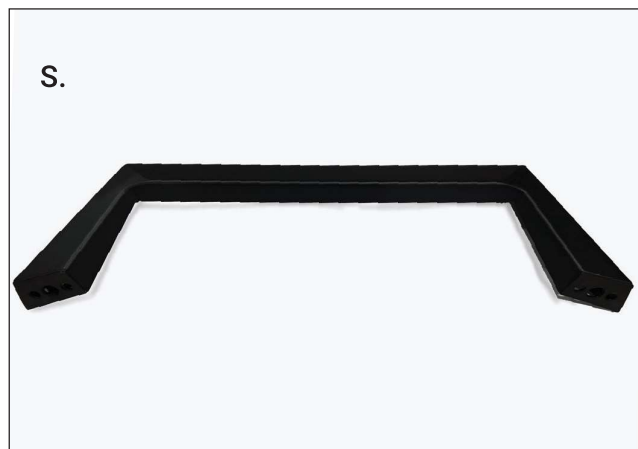
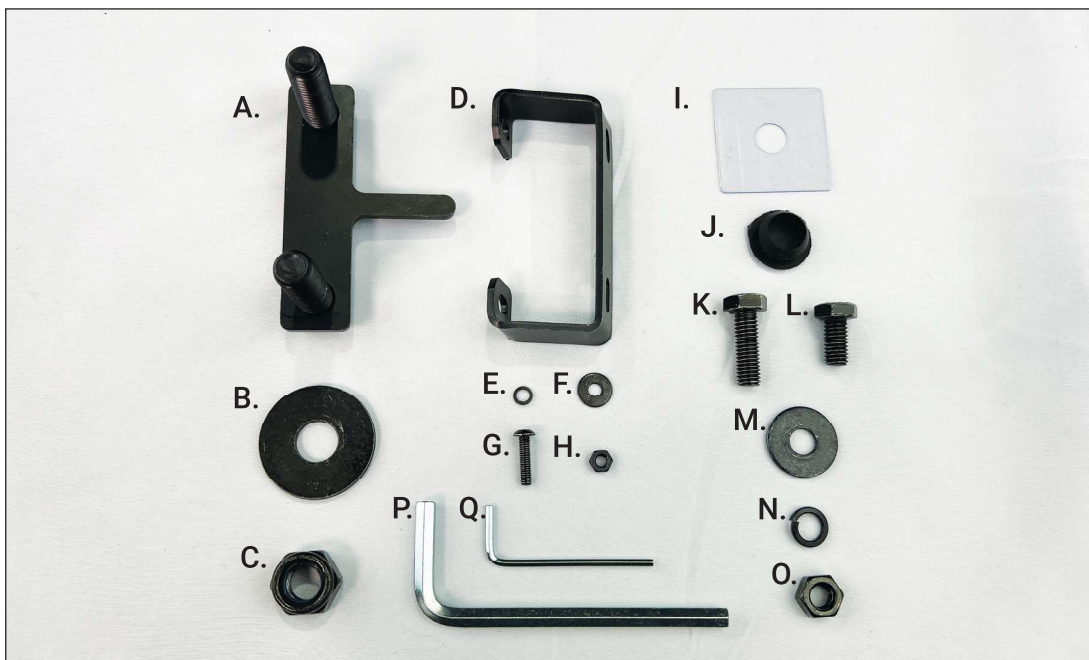

KIT CONTENT LIST:

- A. M12 Tabbed Bolt Plate (x4)
- B. M12 Flat Washer (x8)
- C. M12 Nylock Nut (x8)
- D. Fog Light Bracket (x2)
- E. M4 Lock Washer (x8)
- F. M4 Flat Washer (x20)
- G. M4 Button Head Bolt (x12)
- H. M4 Nut (x8)
- I. M12 Plastic Bolt Retainer (x8)
- J. Rubber Plugs (x4)
- K. M8 1.25 x 24mm (x6)
- L. M8 1.25 x 14mm (x2)
- M. M8 Flat Washer (x14)
- N. M8 Lock Washer (x4)
- O. M8 Nut (x6)
- P. 6mm Hex Key
- Q. 2.5mm Hex Key
- R. Stone Guard
- S. Override Bar

TOOL LIST:

- Safety Glasses
- Gloves
- 7mm Socket
- 8mm Wrench or Socket
- 13mm Wrench or Socket
- 16mm Socket
- 18mm Deep Socket
- 18mm Socket
- 19mm Wrench or Socket
- Flat Blade Screw Driver
- Phillips Head Screw Driver
- Torx T20 Driver
- Trim Removal Tool

NOTICE

THERE MIGHT BE ADDITIONAL HARDWARE AND BRACKETS FOR LIGHT BAR INSTALLATION INCLUDED IN HARDWARE PACK.

Step 1a - Prep to Remove Original Bumper - JK

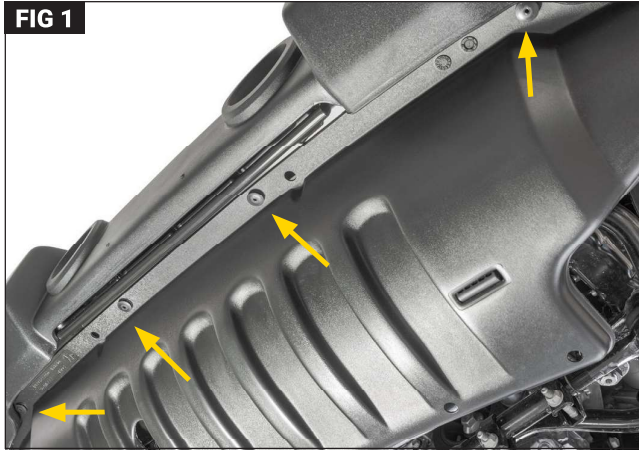

Put on gloves and safety glasses. Start by removing the factory splash guard. Remove the 4 plastic push rivets on the underside of the bumper. (Fig 1) Remove the two plastic push rivets on the underside. (Fig 2) Remove the splash guard.

Note: This will not be reused with your Carnivore bumper.

Step 2a

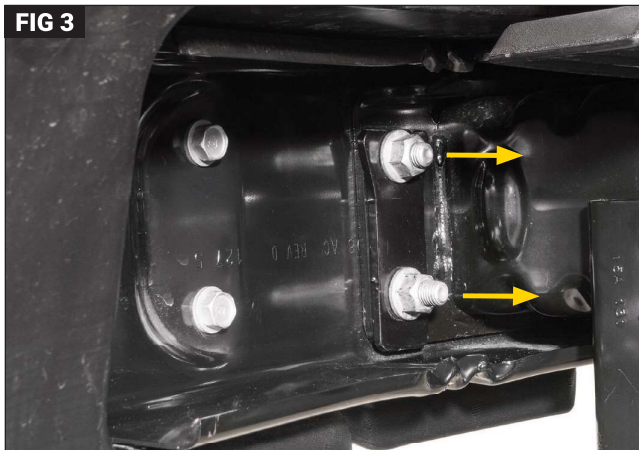

To remove the factory bumper, use an 18mm socket to remove the eight (8) bumper retaining bolts. There are two (2) bolts on each side (inside and outside) of each frame rail. (Fig 3) Carefully remove the bumper from the frame rails. While supporting the bumper, use a pry tool to remove the retaining clips from the backside of the bumper. (Fig 4)

Step 3a

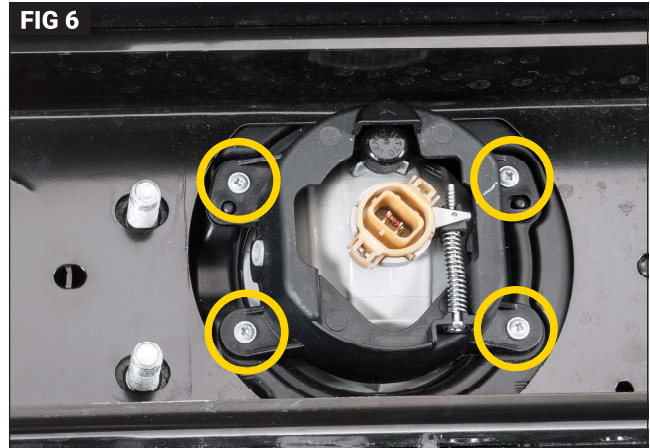

Carefully release the clips and disconnect the factory wiring harness from the bumper mounted fog lights. (Fig 5) Remove the four (4) retaining screws that secure the factory fog lights from the factory bumper. (Fig 6) The factory fog lights will be reused in the Carnivore bumper. You can now set the factory bumper aside.

Step 4a

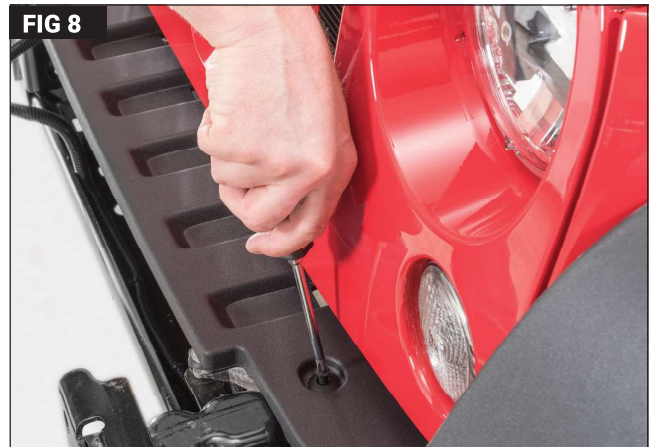

Locate the two plastic screw rivets on the factory frame guard. (Fig 7) Remove the plastic screw rivets with a phillips head screwdriver. Lift the plastic frame guard away. (Fig 8) **Note:** This will not be reused with your Carnivore bumper.

JK INSTALLATION - SKIP TO STEP 13 ON PAGE 12

Step 1b - Prep to Remove Original Bumper - JL and JT

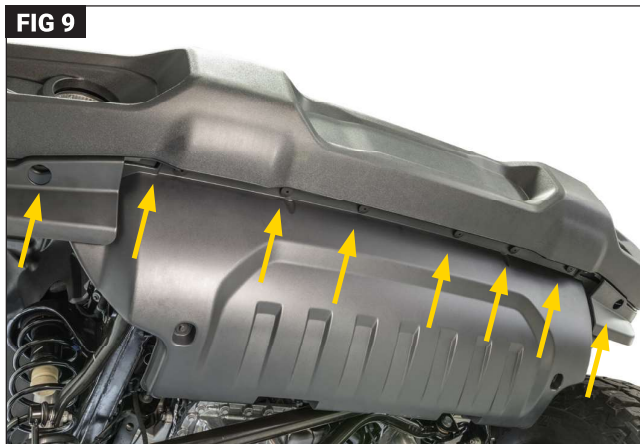

Put on safety glasses. Start by removing the factory splash guard. Remove the 8 plastic push rivets on the underside of the bumper. (Fig 9) Remove the two screws on the underside using a 8mm socket. (Fig 10) Remove the splash guard. **Note:** This will not be reused with your Carnivore bumper.

Step 2b



Remove the two bolts holding on the original equipment cross shield using a 16mm socket. Remove the cross shield by lifting upward and out. (Fig 11) **Note:** This will not be reused with your Carnivore bumper.

Step 3b

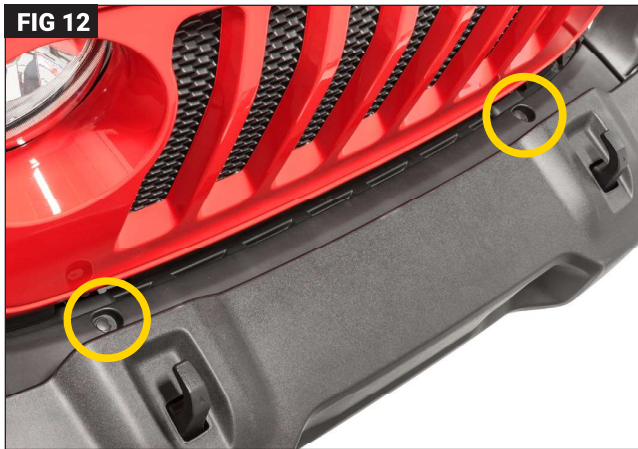

Locate the frame guard plastic retainers on either side. (Fig 12) Remove the plastic retainers using a small flat blade screwdriver. (Fig 13) **Note:** This will not be reused with your Carnivore bumper.

Step 4b - Remove Original Bumper - JL and JT

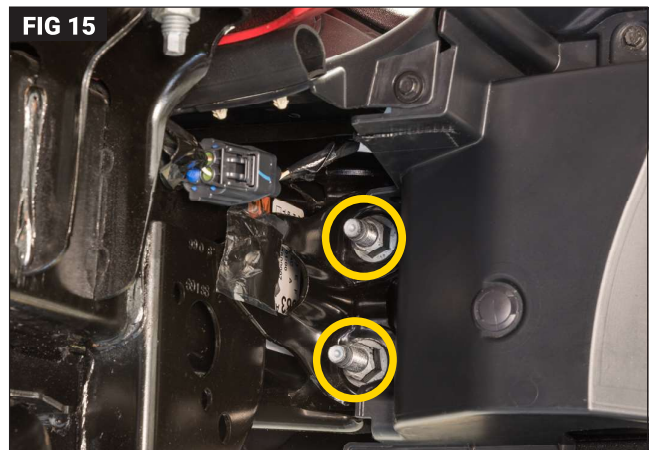

Release the clip on the harness and disconnect the fog light wiring harness plug so the bumper can be removed. (Fig 14) Using a 18mm deep socket remove the eight (8) bumper retaining nuts. There are two (2) on the inside and two (2) on the outside of each frame rail. (Fig 15) With an assistant, carefully remove the bumper from the frame rails by pulling straight forward and away from the front of the vehicle.

Step 5 - Fog Light Removal - Sport Models



For Wrangler Sport Model Vehicles: On the back of the bumper, locate the seven (7) screws on either side holding the splash shields to bumper and remove using a 7mm socket. (Fig 16) Disconnect the factory wiring harness from the bumper mounted fog lights. (Fig 17)

Step 6



Locate the four (4) bolts holding the metal substructure to bumper fascia and remove using a 13mm socket. (Fig 18)

Step 7

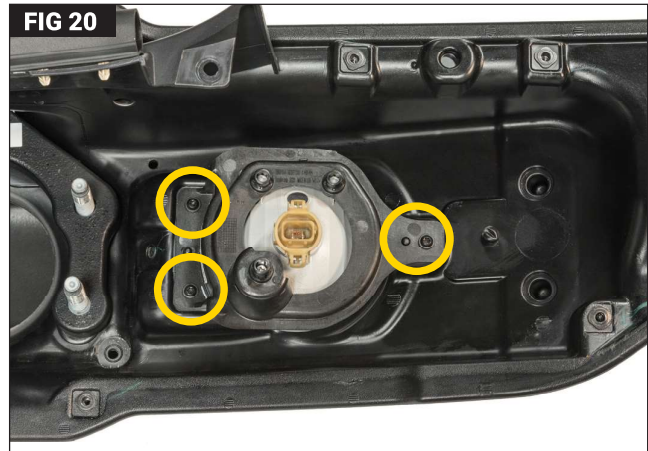

After removal of the substructure, you will be able to access the fog light wiring harness. Remove harness and clips using a trim removal tool and set aside for reuse. (Fig 19) Remove the three (3) screws retaining the fog lamps to bumper fascia using a Torx T20 driver. (Fig 20) Remove fog light and set aside for reuse.

Step 8- Fog Light Removal - Sahara or Rubicon Models

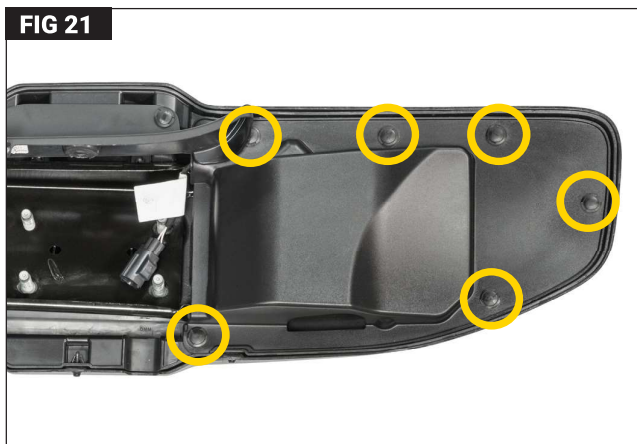

Locate the six (6) plastic fasteners on both sides of the back holding the splash shields to bumper and remove using a flat blade screwdriver. (Fig 21) Disconnect the factory wiring harness from the bumper mounted fog lights as shown in Step 5 for the Sport models. (Fig 17)

Step 9

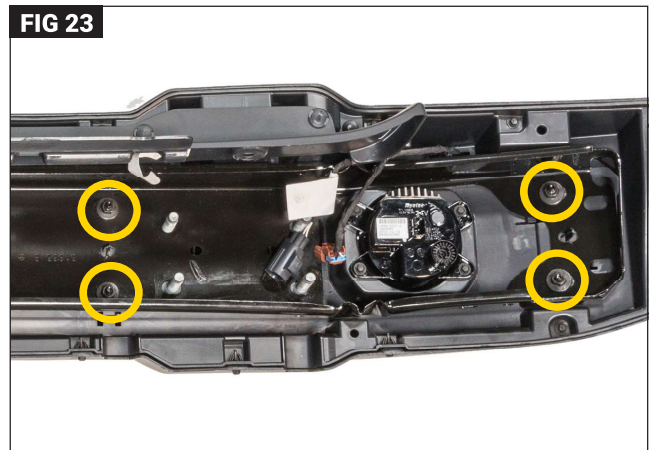
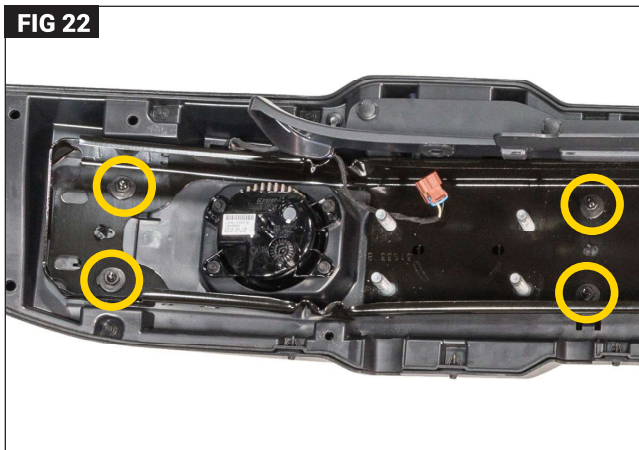

Locate the eight (8) nuts holding the metal sub structure to bumper fascia and remove using a 13mm socket. (Fig 22 & 23)

Step 10

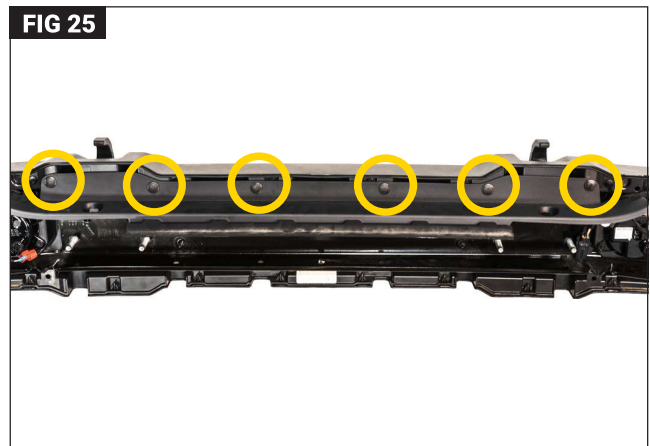
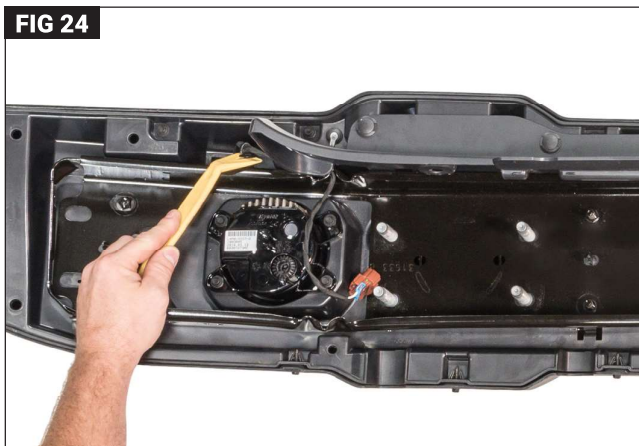

Remove the two (2) fog light wiring harness retainers from metal sub structure using a trim removal tool. (Fig 24)
Locate the six (6) plastic fasteners holding the frame guard to bumper and remove using a flat blade screwdriver. (Fig 25)

Step 11

FIG 26

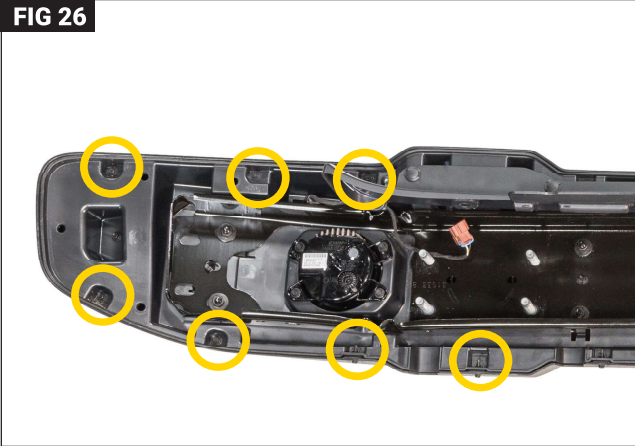

FIG 27



Locate the 24 screws holding bumper halves together and remove using a 7mm socket. (Fig 26) Note: Picture only shows a sample of the screws. Not all are shown. Separate bumper halves and turn over to access the fog light wiring harness. (Fig 27) Remove harness using a trim removal tool set aside for reuse.

Step 12

FIG 28

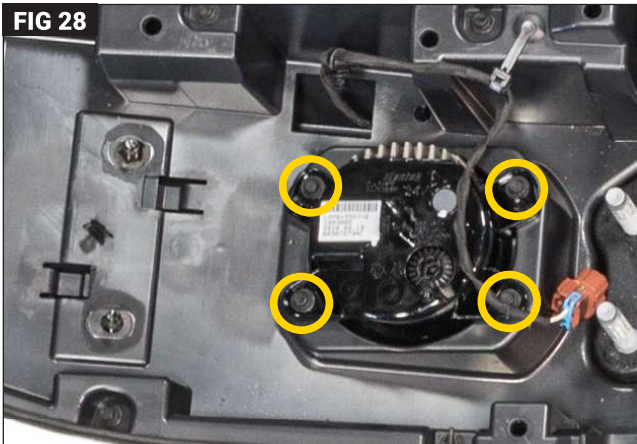

Remove the four (4) screws retaining the fog lamps to bumper fascia using a 7mm socket. (Fig 28)

Step 13 - Fog Light Install on Carnivore Bumper - Sport Models



Locate the fog light mount inside the back of the Carnivore Bumper. (Fig 29) Place the fog light into the mount and align the holes. The two (2) stepped-down holes are pre-threaded. Using two (2) M4 button head bolts and M4 flat washers secure the fog light into the mount. (Fig 30) Do not fully tighten yet. On the other side of the fog light, place two (2) M4 button head bolts and M4 flat washers into the mounting holes. From the underside, place an M4 flat washer, M4 lock washer and an M4 nut on each of the bolts. Align the fog light as needed and then tighten all the bolts to secure fog light. (Fig 31) Repeat for other fog light.

Step 14 - Fog Light Install on Carnivore Bumper - Sahara or Rubicon Models

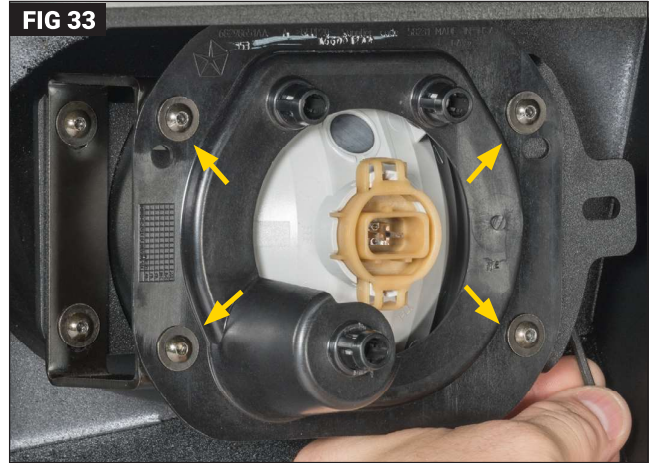
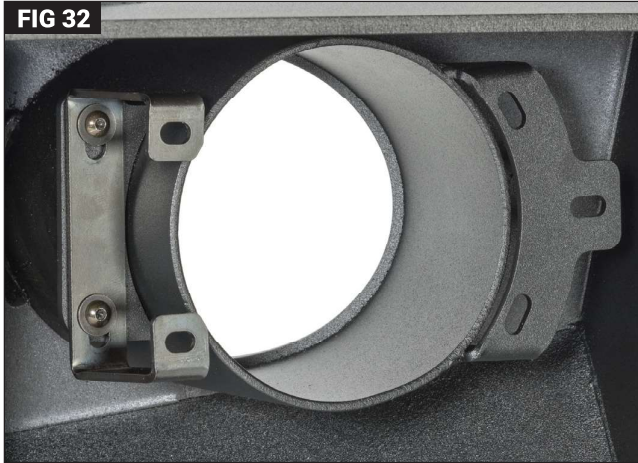

Locate the fog light mount inside the back of the Carnivore Bumper. Loosely attach the supplied fog light bracket to pre-threaded hole in the mount with two M4 button head bolts and two M4 washers using the provided 2.5mm hex key. (Fig 32) Do not fully tighten. Place fog lamp in place and attach to bumper and bracket with four M4 button head screws and washers on both sides and then secure with an M4 lock washer and M4 nut using the provided 2.5mm hex key and a 7mm wrench. (Fig 33). Finally, tighten all six (6) fasteners once fog lamp is in position. Repeat for the other fog light.

Step 15 - Bumper Mount Preparation



Locate the four (4) bolt holes on each side of the slot for mounting bolts on the inside of the Carnivore Bumper. Holding the tab on the bolt plate, carefully place the threaded end into the slot and work into position with the bolts coming up through the elongated holes. This will require an approximate motion that is shown in the yellow arrows. (Fig 34 & 35)

Step 16

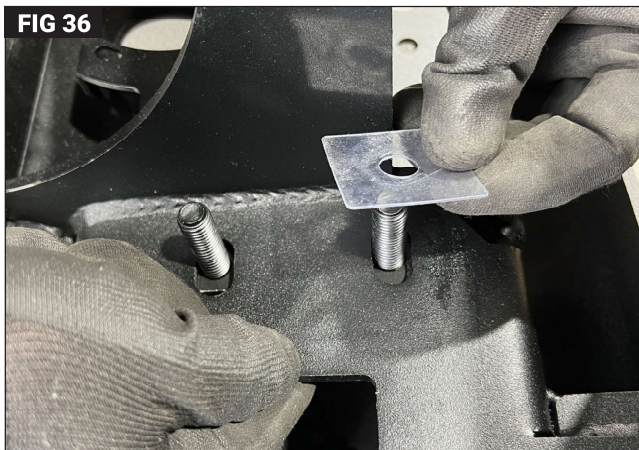

Once the bolts are through the holes with the metal of the bolt plate pressed up against the plate on the bumper, secure the bolts using a provide plastic bolt retainer on each bolt. (Fig 36) Repeat with the remaining three (3) tabbed bolt plate. (Fig 37)

Step 17 - Stone Guard Installation



Use the stone guard to mount optional lighting behind the perforated screen in the bumper. This stone guard can be mounted with included M8 x 14mm bolt, two (2) M8 flat washers and an M8 nut or the mounting hardware of your favorite auxiliary light. Installation is shown with auxiliary light used. With the connecting harness for the light through the wiring hole of the stone guard, insert the mounting bolt from the light into the tab on the bumper behind the screen. (Fig 38) Place a flat washer and nut onto the bolt. (Fig 39) Do not fully tighten.

Step 18



Once auxiliary light is aimed as desired, tighten bolt as needed. (Fig 40) Repeat Steps 17 and 18 for other side.

Step 19 - Override Bar Installation

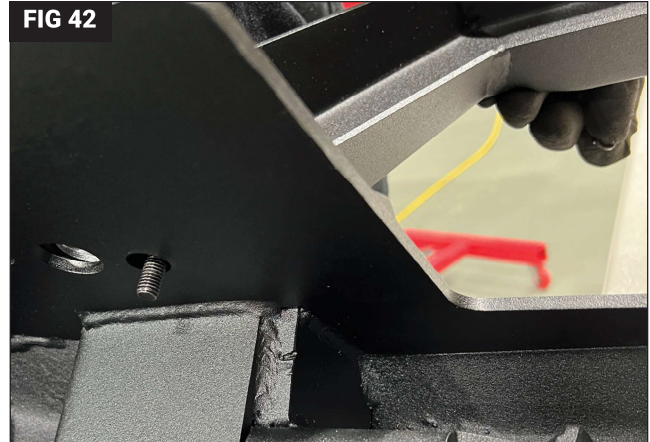
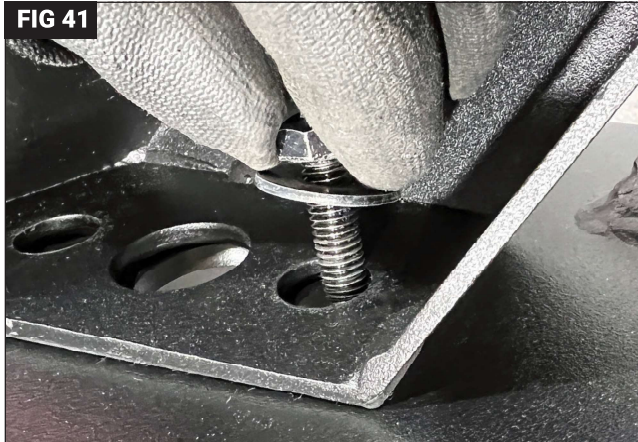

Locate the override bar. Place override bar on the bumper with solid side facing the front of the bumper. Line all six (6) holes on the base of the override with the corresponding holes on the Carnivore Bumper. Using the smaller, outer holes on each side, place an M8 x 24mm with an M8 flat washer through the hole. It is easier if someone holds the bar in place while putting the bolts in. (Fig 41 & 42)

Step 20

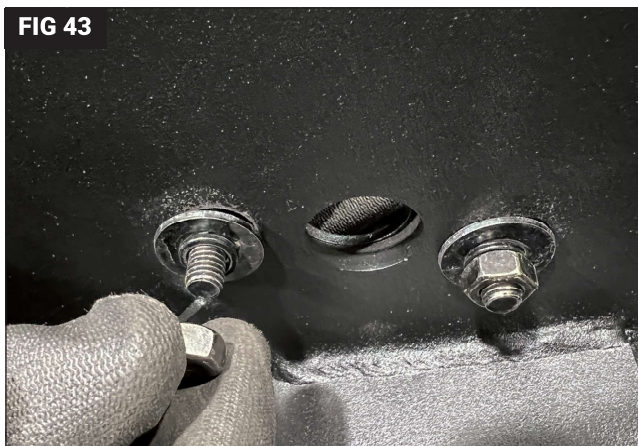

From the underside, place an M8 flat washer, an M8 lock washer and M8 nut on each bolt. (Fig 43) Using a 13mm wrench, tighten the nuts to secure the override bar. (Fig 44)

If choosing not to use the override bar, place the 4 rubber plugs into the smaller bolt holes. (not shown)

Step 21 - Bumper Installation

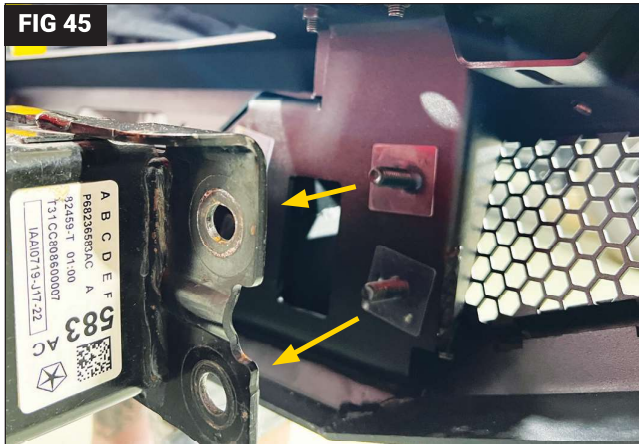

Using an assistant, lift the bumper in position in front of the frame rails. Carefully line up the bolts that are positioned with the plastic retainers. Slowly slide bolts into holes on the plate on the front of the frame rails. (Fig 45) Place an M12 flat washer and M12 nylock nut onto one (1) bolt on each side to hold bumper in place. (Fig 46)

Step 22

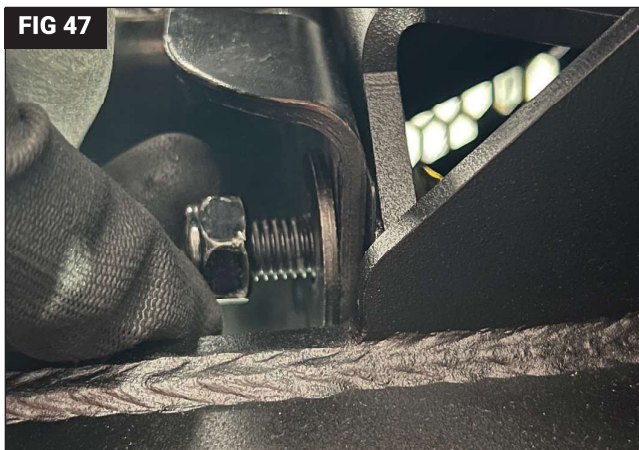

Place the remaining six (6) M12 flat washers and M12 nylock nuts onto the bumper mount bolts. (Fig 47) Tighten and torque to 66ft pounds. (Fig 48)

Connect all lighting harnesses and fog lights. Using cable ties, secure and manage all wiring and harnesses securely behind the bumper.

Congratulations! Installation is complete.

Carnivore Exclusive Three Year Limited Warranty

Your Carnivore branded accessories are covered by the following Limited Warranty provided exclusively by Carnivore, 1028 Saunders Lane, West Chester PA 19380.

This **Limited Warranty** is the only warranty made in connection with your purchase. Carnivore neither assumes nor authorizes any vendor, retailer or other person or entity to assume for it any other obligation or liability in connection with this product or Limited Warranty. This Limited Warranty does not apply and is not cumulative to any accessory or part distributed by Carnivore for which the Manufacturer provides a separate written warranty.

What is Covered:

Subject to the terms, exclusions and limitations herein and with respect only to Carnivore branded accessories first sold in the United States, Carnivore warrants to the initial retail purchaser only that your Carnivore accessory shall be free of defects in material and workmanship: for a period of three (3) years from date of retail purchase.

This **Limited Warranty** is not assignable and shall terminate upon sale of the vehicle upon which the Carnivore accessory is installed or other transfer to third persons.

All other warranties are hereby disclaimed, except to the extent prohibited by applicable law in which case any implied warranty of merchantability or fitness for a particular purpose on this product is limited to 3 years from date of initial retail sale. Carnivore reserves the rights to: **(a.) require invoice or other proof your accessory is within the terms of this Limited Warranty as a condition of warranty service and, (b.) make future revisions to this product and Limited Warranty without prior notice or obligation to upgrade your product.**

What is Not Covered:

Your Carnivore Limited Warranty does not cover products or parts Carnivore determines to have been damaged by or subjected to: **(a.) installation damage, alteration, modification, combination with other parts, failure to maintain or improper repair or service, (b.) normal wear & tear, cosmetic damage or damage from moisture or water immersion, (c.) Acts of God, accidents, misuse, negligence, inadequate mounting or impact with vehicle(s), obstacles or other aspects of the environment, (d.) theft, vandalism or other intentional damage.**

Remedy Limited to Repair/Replacement:

The exclusive remedy provided hereunder shall, upon Carnivore inspection and at option, be either repair or replacement of product or parts (new or refurbished) covered under this Limited Warranty. Customers requesting warranty consideration should first contact Carnivore to obtain a RGA number (610-701-3336). All labor, removal, shipping and installation costs are customer's responsibility.

Other Limitations - Exclusion of Damages - Your Rights Under State Law:

In consideration of the purchase price paid, neither Carnivore nor any independent Carnivore distributor/licensee are responsible for any time loss, rental costs, or for any incidental, consequential, punitive or other damages you may have or incur in connection with any part or product purchased. Your exclusive remedy hereunder for covered parts is repair/replacement as described above.

This **Limited Warranty** gives you specific rights. You may also have other rights that vary from state to state. For example, some states do not allow limitations of how long an implied warranty lasts and /or do not allow the exclusion or limitation of incidental or consequential damages, so the limitations and exclusions herein may not apply to you.

Carnivore 2022. All Rights Reserved.
A4 Version 5/25/2022

Instructions Part #12999.3241

