

Carnivore Side Steps

For 2007-2018 Jeep® Wrangler JK

Assembly and Installation Manual #12056-3104

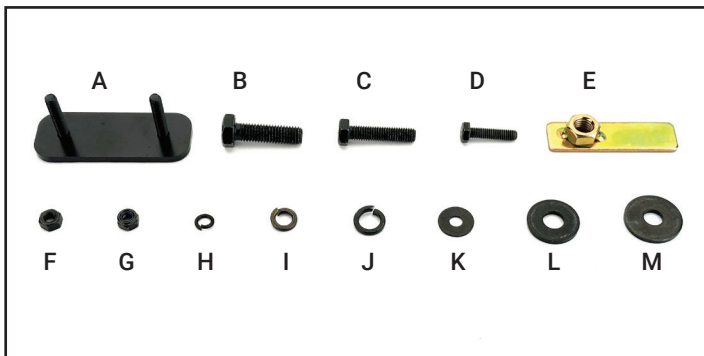

KIT CONTENTS LIST:

- A. M6-1.0 Double Bolt Anchor Plate (x4)
- B. M10-1.50 x 35mm Bolt (x4)
- C. M8-1.25 x 35mm Bolt (x4)
- D. M6-1.0 x 25mm Bolt (x8)
- E. M10-1.50 Nut Plate (x4)
- F. M6-1.0 Nut (x8)
- G. M6-1.0 Nylock Nut (x8)
- H. M6 Lock Washer (x8)
- I. M8 Lock Washer (x4)
- J. M10 Lock Washer (x4)
- K. M6 Flat Washer x 18mm Diameter (x24)
- L. M10 Flat Washer x 26mm Diameter (x4)
- M. M8 Flat Washer x 28mm Diameter (x4)
- N. Left Front Mounting Bracket (x1)
- O. Left Rear Mounting Bracket (x1)
- P. Right Front Mounting Bracket (x1)
- Q. Right Rear Mounting Bracket (x1)
- R. Side Step Assembly – Left Side
- S. Side Step Assembly – Right Side

NOTICE

INCLUDED IN THE PARTS CONTENTS ARE FOUR MOUNTING BRACKETS. EACH BRACKET IS UNIQUE AND THE CORRECT PLACEMENT FOR EACH BRACKET IS DETAILED ON THE FOLLOWING PAGE.

REQUIRED TOOLS:

Safety Glasses
 3/8" Drive Socket Wrench
 16MM Socket

13MM Socket
 10MM Deep Socket
 10MM Wrench



MOUNTING BRACKET & SIDE STEPS IDENTIFICATION:

Left Front Mounting Bracket

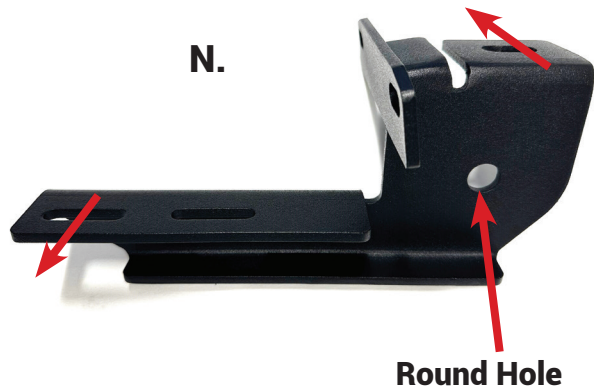

Left Rear Mounting Bracket

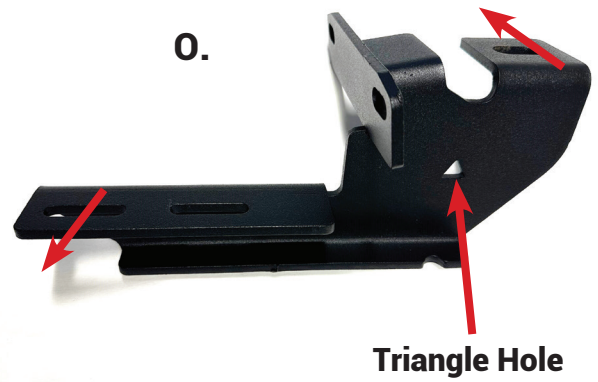

Right Front Mounting Bracket

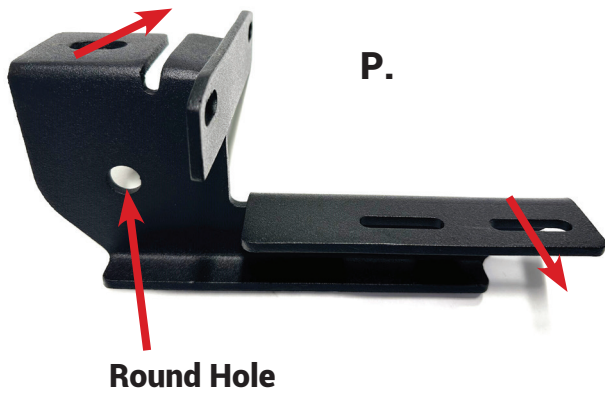

Right Rear Mounting Bracket

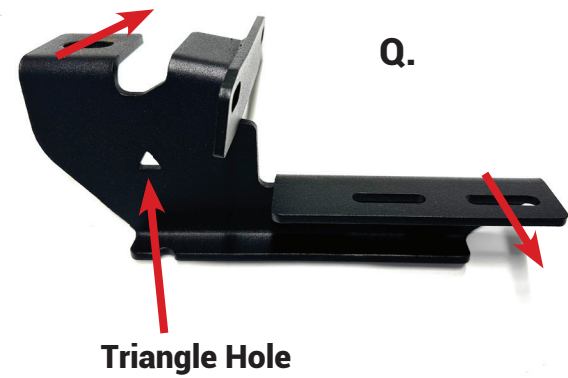

NOTICE





EACH BRACKET IS SPECIFICALLY MATCHED TO A LOCATION. TAKE THE TIME TO VISUALLY MATCH THE CORRECT BRACKET WITH THE CORRESPONDING LOCATION ON THE VEHICLE. TAKE NOTE OF THE NOTCHES THAT ARE USED TO HELP IDENTIFY EACH BRACKET.



A Few Words About Product Safety:

Your Carnivore Side Steps are intended to enhance the utility and enjoyment of your Jeep® vehicle. Before installation, please review the following safety information and installation recommendations. Throughout these instructions important safety information is generally preceded by one of the three signal words indicating the relative risk of injury, property damage or adverse consequence.







The signal words mean:

 WARNING 	A HAZARDOUS SITUATION WHICH, IF NOT AVOIDED, COULD RESULT IN DEATH OR SERIOUS INJURY. YOU CAN BE KILLED OR SERIOUSLY HURT IF YOU DO NOT FOLLOW INSTRUCTIONS.
 CAUTION 	A HAZARDOUS SITUATION WHICH, IF NOT AVOIDED, COULD RESULT IN MINOR OR MODERATE INJURY. YOU CAN BE MODERATELY HURT AND ALSO MAY SUFFER PROPERTY DAMAGE IF YOU DO NOT FOLLOW INSTRUCTIONS.
NOTICE	CAREFUL ATTENTION IS REQUIRED TO THIS INSTRUCTION OR OPERATION BUT DOES NOT GENERALLY RELATE TO PERSONAL INJURY. DAMAGE TO YOUR QUADRATEC® PRODUCT OR OTHER PROPERTY MAY RESULT IF YOU DO NOT FOLLOW INSTRUCTIONS.

UNPACKING:

BEFORE YOU BEGIN USAGE:

Congratulations on your purchase of Carnivore Side Steps. When unpacking, check to make sure all parts are included and not damaged due to shipping. If any part is missing or broken, please call Customer Service at 800-745-6037 as soon as possible. Thank you again for your purchase and let's start the installation process.

 WARNING 	TO REDUCE THE RISK OF SERIOUS INJURY OR PROPERTY DAMAGE: READ ALL SAFETY MESSAGES AND UNDERSTAND ALL INSTRUCTIONS AND PROCEDURE NOTICES BEFORE ATTEMPTING TO INSTALL OR USE THIS PRODUCT.
 CAUTION 	RISK OF EYE INJURY! SAFETY GLASSES MUST BE WORN AT ALL TIMES WHILE INSTALLING OR MAINTAINING THIS PRODUCT. DO NOT USE IF DAMAGED.
NOTICE	CHECK STATE AND LOCAL HIGHWAY SAFETY LAWS REGARDING PERMITTED ON-ROAD EQUIPMENT.
 CAUTION 	DO NOT USE THE STEP AS A WINCH/SELF-RECOVERY ATTACHMENT POINT.



PART I: INSTALLATION TYPE

STEP 1 - DETERMINE THE MOUNTING BRACKET INSTALLATION TYPE:

Put on safety glasses. NOTE: There are two different types of fastening steps to install the mounting brackets to the underbody. The earlier design shown in (FIG 1) uses a Bolt (B), Lock Washer (J), Flat Washer (L) and Nut Plate (E). The later design shown in FIG 2 uses a Bolt (C), Lock Washer (I) and Flat Washer (M) to install the bracket to the underbody.

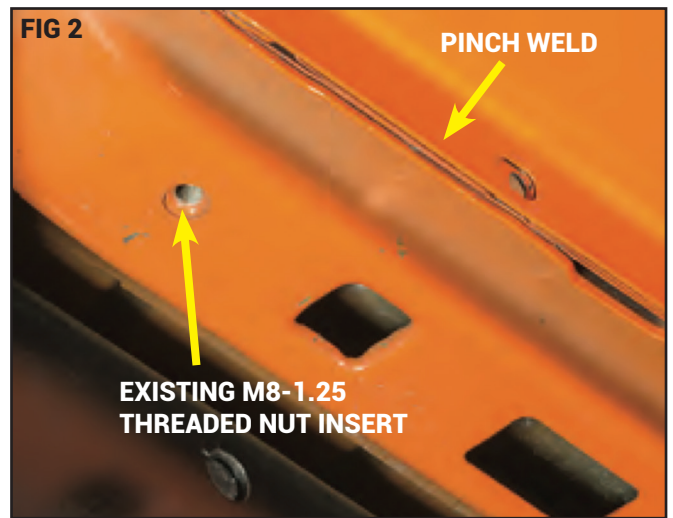
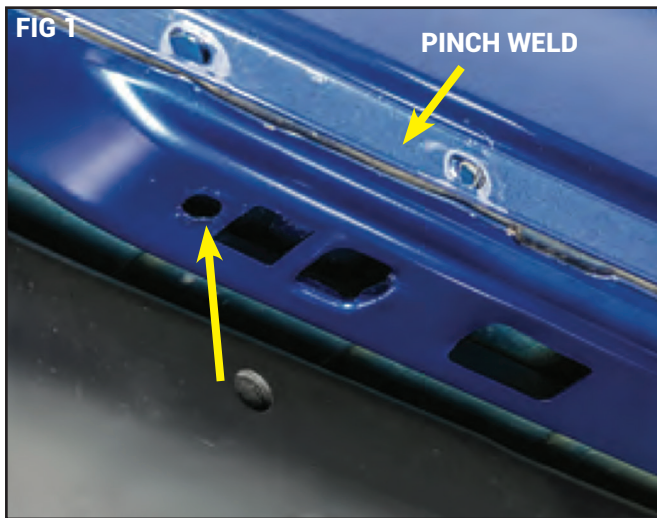

STEP 2 - NUT PLATE INSTALLATION REQUIRED:

If your vehicle has the earlier mounting style shown in (FIG 1), install all four M10-1.50 Nut Plates (E) at this time as shown in (FIG 3) and (FIG 4).

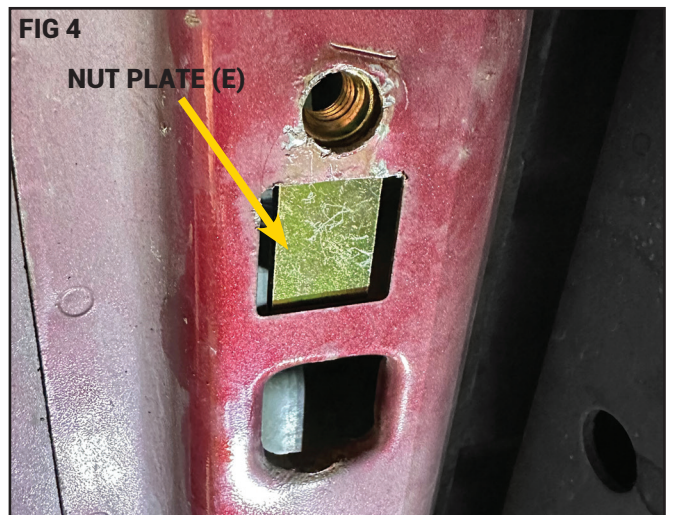
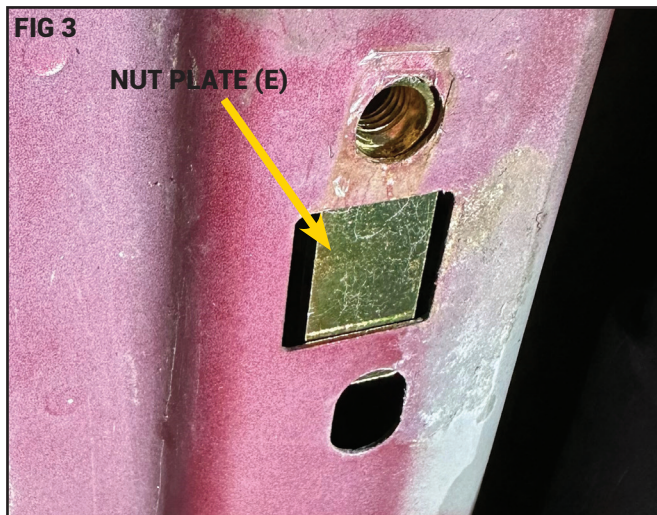

PART I: INSTALLATION TYPE CON'T

STEP 3 - MOUNTING BRACKET INSTALLATION:

Each mounting bracket attaches behind the rocker panel pinch weld (FIG 5). Once you have identified the underbody attachment type, proceed with installing all 4 Mounting Brackets M, N, O and P to their respective positions using the correct underbody hardware outlined in (STEPS 1 & 2). Do not fully tighten for now. Further attach each bracket with two M6-1.0 x 25mm Bolts (D) and two M6 Flat Washers (K). See (FIG 5). Secure each bracket bolt with an M6 Flat Washer (K), M6 Lock Washer (H) and M6-1.0 Nut (F). See (FIG 6). Once all fasteners are in place, fully tighten the underbody bolts first with a 16mm or 13mm socket depending on the underbody mount type from (FIG 1) or (FIG 2). Then tighten the pinch weld bolts for each mounting bracket using a 10mm socket and wrench.

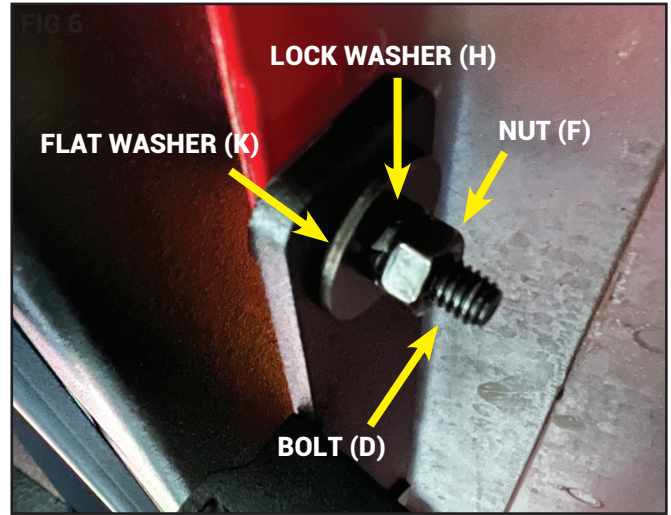
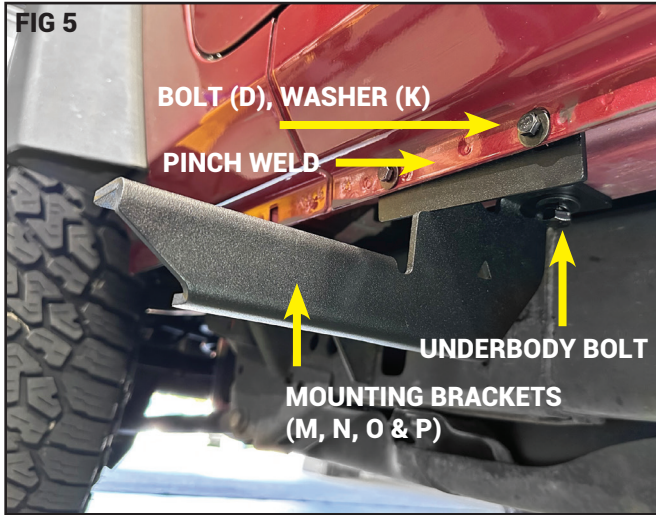

PART II: SIDE STEP INSTALLATION

STEP 1 - LINE UP STEPS TO MOUNTING BRACKETS:

Lay each preassembled Side Step (R, S) onto their respective mounting bracket locations (FIG 7). Secure each Step to their mounting brackets using the two M6-1.0 Double Bolt Anchor Plates (A). Insert anchor plates under the lip of the anchor plate channel and locate the threaded studs through each Mounting Bracket (FIG 8).

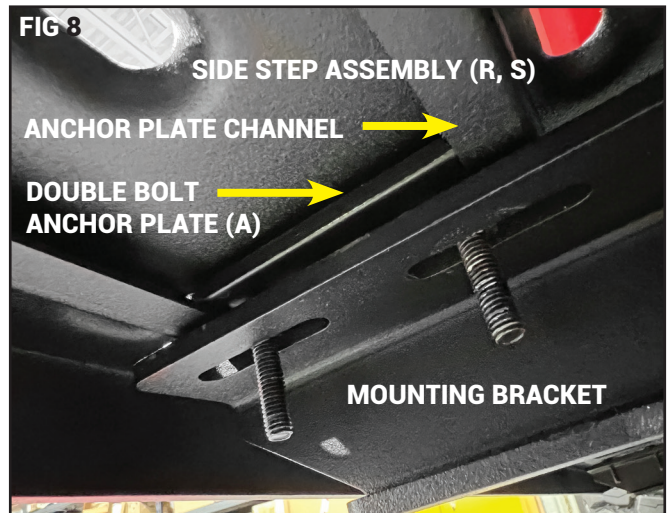
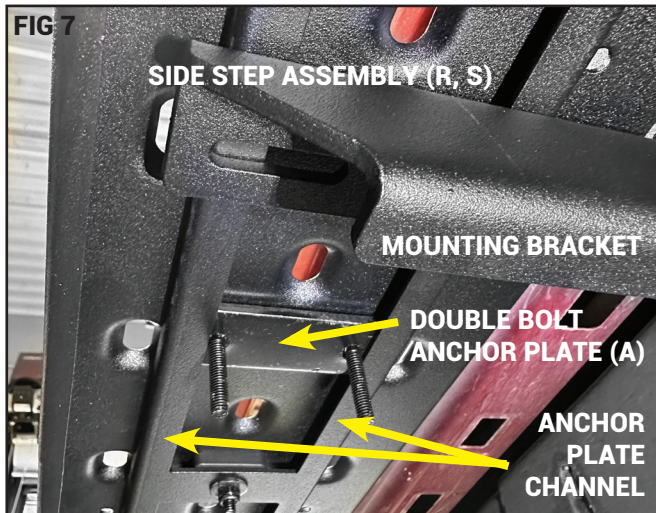

PART II: SIDE STEP INSTALLATION CON'T

STEP 2 - LINE UP STEPS & TIGHTEN HARDWARE :

Secure each Anchor Plate to each Mounting Bracket with M6 Flat Washers and M6 Nylock Nuts (FIG 9). Before fully securing the Nylock Nuts (G), center each Side Step platform. See (FIG 10). It is recommended to leave a 1/2" gap between the pinch weld and platform. Once the platform is in the desired location, use a 10mm Deep Socket to tighten all anchor plate nuts to the Mounting Brackets.

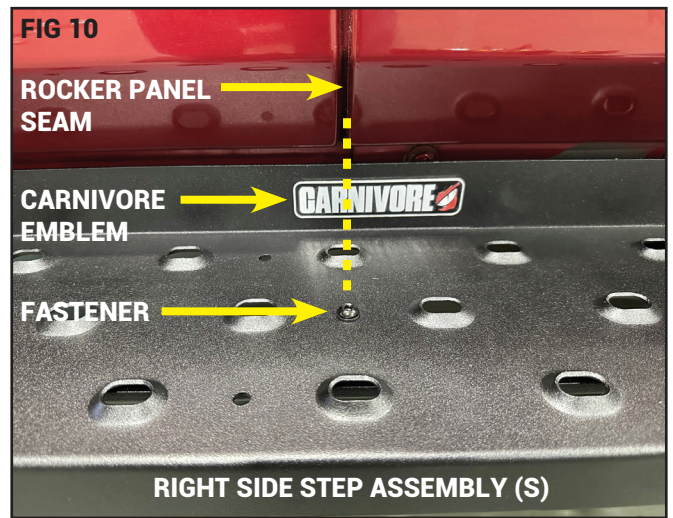
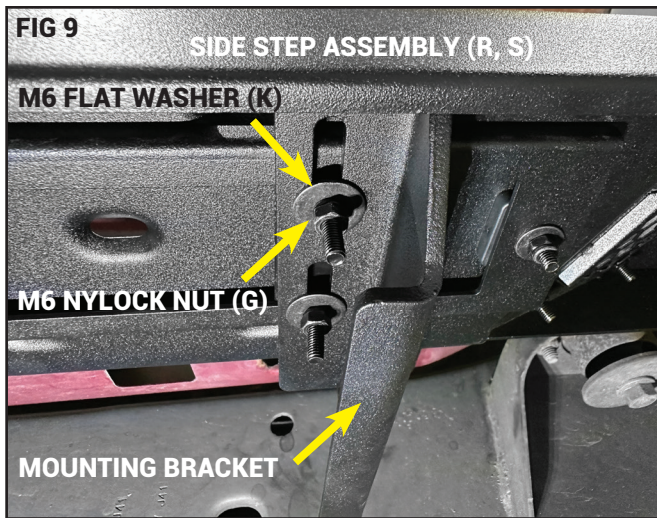

INSTALLATION IS NOW COMPLETE



Carnivore Exclusive Three Year Limited Warranty

Your Carnivore branded accessories are covered by the following Limited Warranty provided exclusively by Carnivore, 1028 Saunders Lane, West Chester PA 19380.

This **Limited Warranty** is the only warranty made in connection with your purchase. Carnivore neither assumes nor authorizes any vendor, retailer or other person or entity to assume for it any other obligation or liability in connection with this product or Limited Warranty. This Limited Warranty does not apply and is not cumulative to any accessory or part distributed by Carnivore for which the Manufacturer provides a separate written warranty.

What is Covered:

Subject to the terms, exclusions and limitations herein and with respect only to Carnivore branded accessories first sold in the United States, Carnivore warrants to the initial retail purchaser only that your Carnivore accessory shall be free of defects in material and workmanship: for a period of three (3) years from date of retail purchase.

This **Limited Warranty** is not assignable and shall terminate upon sale of the vehicle upon which the Carnivore accessory is installed or other transfer to third persons.

All other warranties are hereby disclaimed, except to the extent prohibited by applicable law in which case any implied warranty of merchantability or fitness for a particular purpose on this product is limited to three (3) years from date of initial retail sale. Carnivore reserves the rights to: **(a.) require invoice or other proof your accessory is within the terms of this Limited Warranty as a condition of warranty service and, (b.) make future revisions to this product and Limited Warranty without prior notice or obligation to upgrade your product.**

What is Not Covered:

Your Carnivore Limited Warranty does not cover products or parts Carnivore determines to have been damaged by or subjected to:

(a.) installation damage, alteration, modification, combination with other parts, failure to maintain or improper repair or service, (b.) normal wear & tear, cosmetic damage or damage from moisture or water immersion, (c.) Acts of God, accidents, misuse, negligence, inadequate mounting or impact with vehicle(s), obstacles or other aspects of the environment, (d.) theft, vandalism or other intentional damage.

Remedy Limited to Repair/Replacement:

The exclusive remedy provided hereunder shall, upon Carnivore inspection and at our option, be either repair or replacement of product or parts (new or refurbished) covered under this Limited Warranty. Customers requesting warranty consideration should first contact Carnivore to obtain a RGA number (610-701-3336). All labor, removal, shipping and installation costs are customer's responsibility.

Other Limitations - Exclusion of Damages - Your Rights Under State Law:

In consideration of the purchase price paid, neither Carnivore nor any independent Carnivore distributor/licensee are responsible for any time loss, rental costs, or for any incidental, consequential, punitive or other damages you may have or incur in connection with any part or product purchased. Your exclusive remedy hereunder for covered parts is repair/replacement as described above.

This **Limited Warranty** gives you specific rights. You may also have other rights that vary from state to state. For example, some states do not allow limitations of how long an implied warranty lasts and /or do not allow the exclusion or limitation of incidental or consequential damages, so the limitations and exclusions herein may not apply to you.

©Carnivore, 2023. All Rights Reserved.



A4 Version 11/14/23
Instructions Part #12999-3210

