



1-800-779-2102

Mon – Thurs: 8:00am - 5:00pm | Friday: 8:00am - 4:00pm CST

**INSPECT YOUR PRODUCT FOR DAMAGE & MISSING
PARTS BEFORE PROCEEDING TO INSTALLATION**

PROCEDURE FOR RETURNS OR MISSING HARDWARE

-PLEASE CONTACT THE ORIGINAL POINT OF PURCHASE FOR:
SHIPPING DAMAGE, RETURNS, OR WARRANTY CLAIMS

-CONTACT DEE ZEE DIRECTLY FOR MISSING PARTS OR HARDWARE

WWW.DEEZEE.COM

REGISTER YOUR PRODUCT ONLINE: www.deezee.com/registration

VIEW INSTRUCTIONS ONLINE: www.deezee.com/instructions

⚠ WARNING: Cancer and Reproductive Harm
www.P65Warnings.ca.gov

Operating, servicing, and maintaining a passenger vehicle can expose you to chemicals such as lead, phthalates, engine exhaust, and carbon monoxide that are known to the State of California cause cancer and birth defects or other reproductive harm. To minimize exposure, service your vehicle and its accessories in a well-vented area and wear gloves or wash your hands frequently.



DEE ZEE, INC. WARRANTY AGREEMENT

Dee Zee, Inc. guarantees the original purchaser a limited lifetime warranty against manufacturer defects in materials, workmanship, and design under normal use, excluding damage resulting from road hazards such as gravel or other debris, product misuse, improper installation, impairments from accidents, product modifications, improper repairs, spills, vandalism, product neglect, or acts of God.

This warranty applies only to the original purchaser of new product(s) and is limited to the replacement of genuine Dee Zee products. Modification of any kind to Dee Zee products voids all warranty coverage. Warranty does not include electrical components, installation, cost of removal, labor, transportation costs, loss of use, inconvenience, or consequential damages.

WARRANTY COVERAGE - MATERIALS & WORKMANSHIP

LIMITED LIFETIME WARRANTY:

- **STAINLESS STEEL:** Side Steps, Grill Guards, Bull Bars, Bed Caps, and Side Rails
- **ALUMINUM:** Side Steps, Running Boards, Storage Boxes, Transfer Tanks, Bed Protection, Side Rails, Invis-A-Racks, and Cab Racks
- **PLASTIC:** Storage Boxes
- **OTHER:** Front and Rear Bumpers

THREE-YEAR WARRANTY:

- **POWDER-COATED / E-COATED STEEL:** Side Steps, Running Boards, Storage Boxes, Transfer Tanks, Cab Racks, Sport Bar Ladder Racks, Cargo Carriers, Mounting Brackets (NX, Rough Step, and Bumper Guards only)
- **OTHER:** Tailgate Assist, Bed Mats, Floor Mats, Auxiliary Fuel Connection Kits, and All Products Not Otherwise Listed Individually

WARRANTY COVERAGE – FINISH PROTECTION

The finish of all Dee Zee products is covered for one-year (1) from the date of purchase. Dee Zee products have a high quality finish that must be cared for and maintained like any other exposed finish on the vehicle. Protect the finish with non-abrasive automotive wax (e.g. Pure Carnauba) on a regular basis. Applying soaps, polishes, or waxes that contain an abrasive compound may scratch the finish and leave the exposed material susceptible to corrosion.

WARRANTY COVERAGE – COMPONENT PARTS

Operational items such as shocks, latches, hinges, and wear items including, but not limited to, mud flaps, step pads, toolbox tray, end caps, hardware, seals, etc. have a one-year (1) warranty. Replacement component parts can be ordered via credit card (MasterCard or VISA) by calling 1-800-779-2102. All replacement parts are non-returnable and non-refundable.

GPI® FUEL PUMPS & ACCESSORIES

All Great Plains Industries (GPI) products, including transfer tank pumps and fuel meters are covered by GPI's warranty policies. Dee Zee's warranty terms do not apply to GPI products. To submit a warranty claim, please contact GPI at 1-800-835-0113 or visit www.gpi.net.

WARRANTY SUBMISSION PROCEDURE

All warranty claims will be initiated at the place of purchase. The original purchaser will be required to present the original sales receipt with purchase date shown and provide photographs of the defect.

In the event the originally purchased product style is no longer available, Dee Zee will warranty the defective part with a current equivalent. If a comparable product is no longer available, the product would be returned to the store of purchase for a refund or the applicable cost difference can be paid to choose an alternate style.

DISCLAIMER

All products are sold as appearance accessories and should not be relied upon as protection for the vehicle or its occupants in the event of an accident. Vehicles equipped with a supplemental restraints system (air bags) deployed by impact and collision avoidance systems should not be modified in any way. Always consult the vehicle manufacturer if you have any questions regarding supplemental restraint systems and sensors.

Buyer must accommodate front and rear sensors during product installation and assumes all risk should these be tampered, rerouted, severed, or disconnected. This includes disabling visual, audio, or vibration alerts into the cab. Buyer assumes all risk and responsibility for wiring any supplemental auxiliary lights.

Buyer assumes all risk, liability, and cost for the installation and use of Dee Zee products. Dee Zee, Inc. assumes no liability for injury, loss, incidental or consequential damages in the event of an accident.



Thank you for choosing Dee Zee to add function and accessorize your vehicle. Dee Zee has been a staple brand in the truck accessory market since 1977 and we hold a reputation of quality manufacturing based in America's Heartland. Our products are born through careful engineering and backed by industry leading warranty programs. We appreciate the opportunity to serve you and your vehicle!

Review the instruction pages in their entirety to prepare the required tools

Warning: Please check for wiring or other obstructions before drilling any holes in the vehicle. If it is necessary to drill any holes, Dee Zee recommends putting a sealant or rust inhibitory around all holes drilled into the body of the vehicle.

It is the sole responsibility of the vehicle owner to check for tire clearance. It is unlawful and dangerous to ride on any external vehicle step while the vehicle is in motion.

Cleaning: To be entitled to all warranty rights offered with the product, Dee Zee steps need to be cleaned regularly with a mild detergent. Do NOT use abrasive cleaners. For stainless steel products, the application of a high grade automotive wax is recommended.









Dee Zee Cares - Please Recycle

For an electronic version of these instructions visit: www.deezee.com/instructions

Register your product online: www.deezee.com/registration

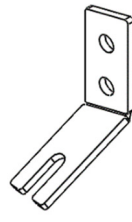
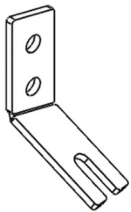
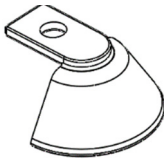
JL A-Pillar Light Bracket Installation Instructions

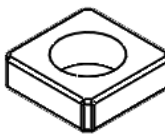
DZ 4446JL Jeep Wrangler JL 2019-Current

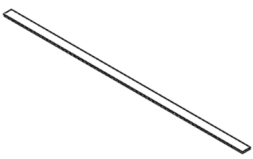
<p>A Driver A-Pillar Bracket</p>  <p>B 2606LWP X1</p>	<p>B Passenger A-Pillar Bracket</p>  <p>B 2606RWP X1</p>	<p>C Accessory Mount Bracket</p>  <p>B 2603LP X1</p>	
<p>D Accessory Mount Bracket</p>  <p>B 2603RP X1</p>	<p>E Bolt-On Half Hex Endcap</p>  <p>EC DZE-620 X2</p>	<p>F M8 X 16mm Button Head Bolt</p>  <p>PN 1261 X8</p>	
<p>G M8 X 12mm Button Head Bolt</p>  <p>PN 1260 X6</p>	<p>H M8 Square Nut</p>  <p>PN 1262 X6</p>	<p>I M8 Hex Flange Nut</p>  <p>PN 526 X8</p>	
<p>J Alcohol Pad</p>  <p>ALPAD X2</p>	<p>K 3M Double Sided Tape</p>  <p>TAPE-25 X2</p>	<p>TO INSTALL THIS BRACKET KIT YOU MUST HAVE BRACKET KIT DZ 4445JL PREVIOUSLY INSTALLED ON THE JEEP.</p>	

Required tools



Ratchet / Wrench
13mm

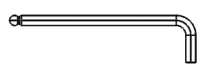

Allen Wrench
5mm



Tape Measure

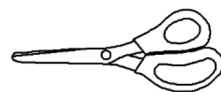

Scissors

- 1** First cut the two pieces of double sided tape (K) in half making 4 pieces total

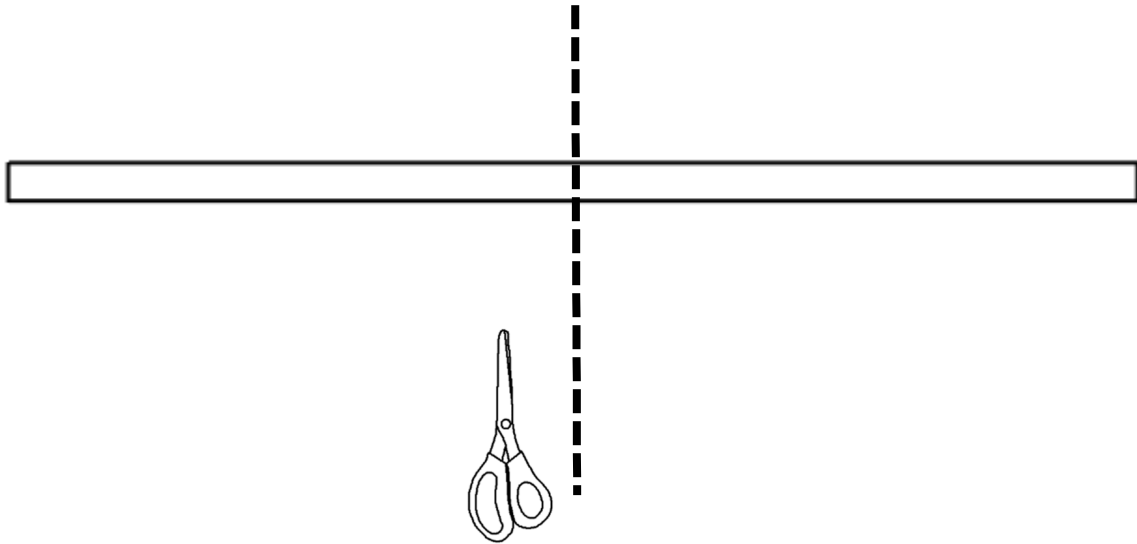

- 2** Measure from the top of the driver bracket (A) 6 inches down and use an alcohol pad (J) to clean off the next 6 inches of the inside surface of the bracket on each side. Then peel off one side to the tape and apply it 6 inches down from the top of the bracket as shown. Repeat on passenger bracket (B) using the same alcohol pad.

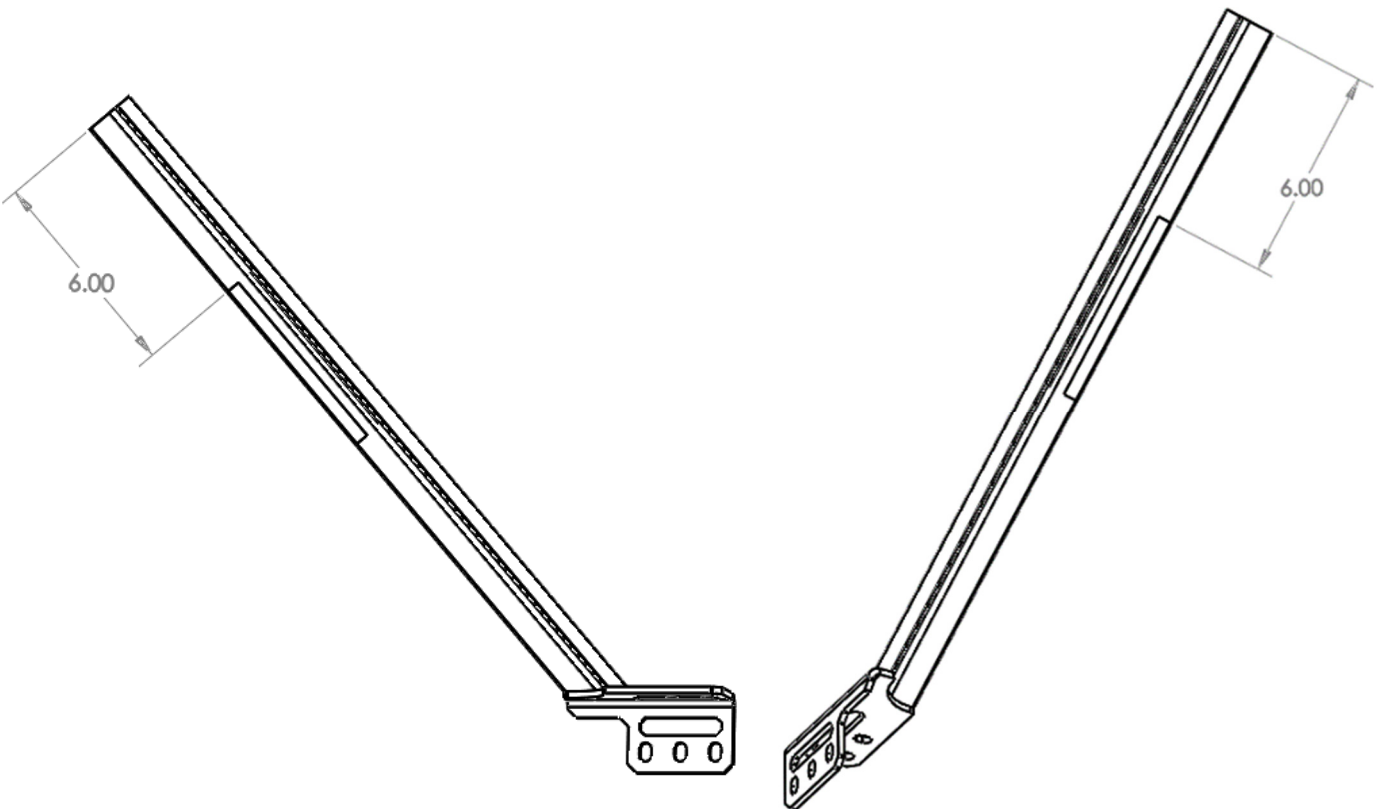

3

Peel up one corner of the double sided tape to the outside of the bracket. Then use alcohol pad (J) to clean off the A-pillar on the jeep in the area shown in the picture below. Repeat this step with the passenger bracket and the passenger side A-pillar.



4

Set driver bracket on the previous installed cowl bracket to see what slots will be used. Install bolts (F), and nuts (I) through the slots of the driver side bracket cowl bracket and the driver A-pillar bracket. Make sure the backing of the double sided tape is showing before tightening the bolts.

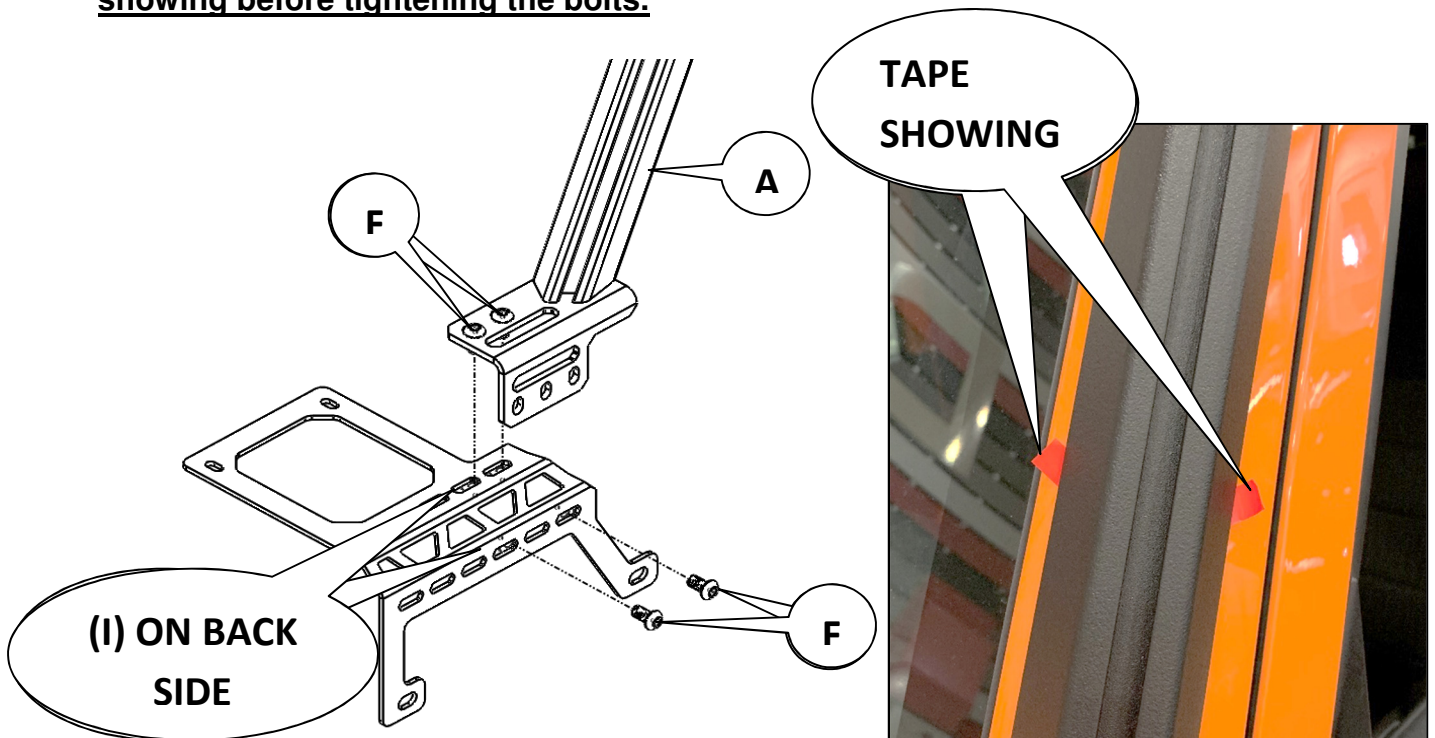

5 Remove the backing of the tape and push the bracket against the vehicle.

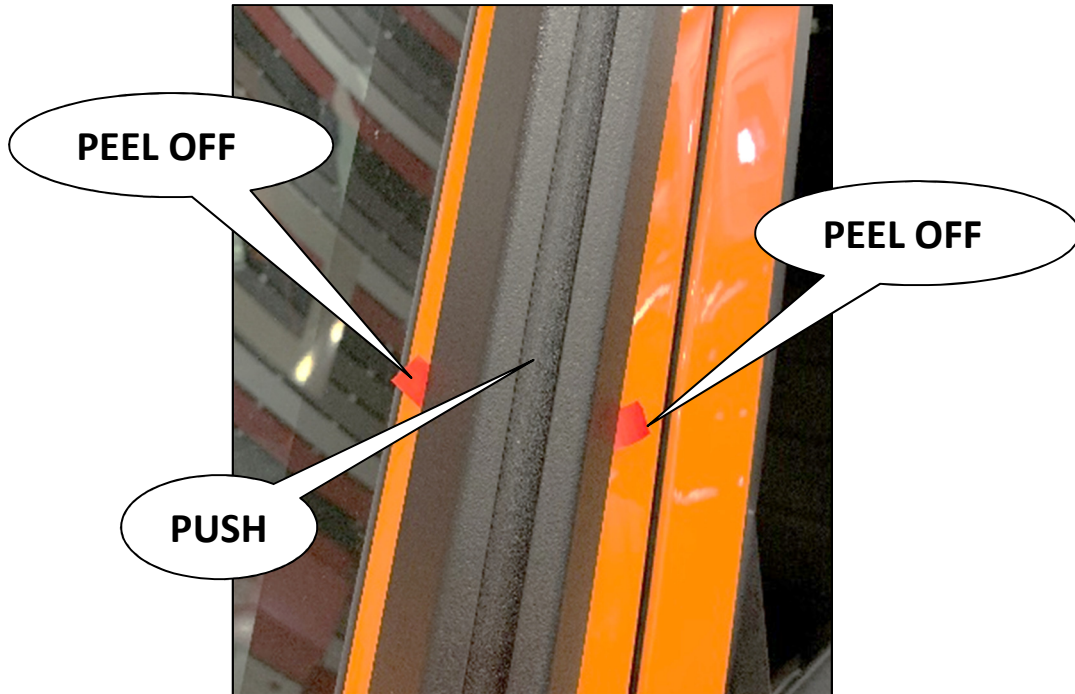

6 Mounting the accessory mount bracket (C) is optional. If you want to mount the accessory mount bracket install bolt (G) through the bracket and put a nut (H) on the back side and slide the bracket in the channel and locate the desired position. Fully tighten bracket.

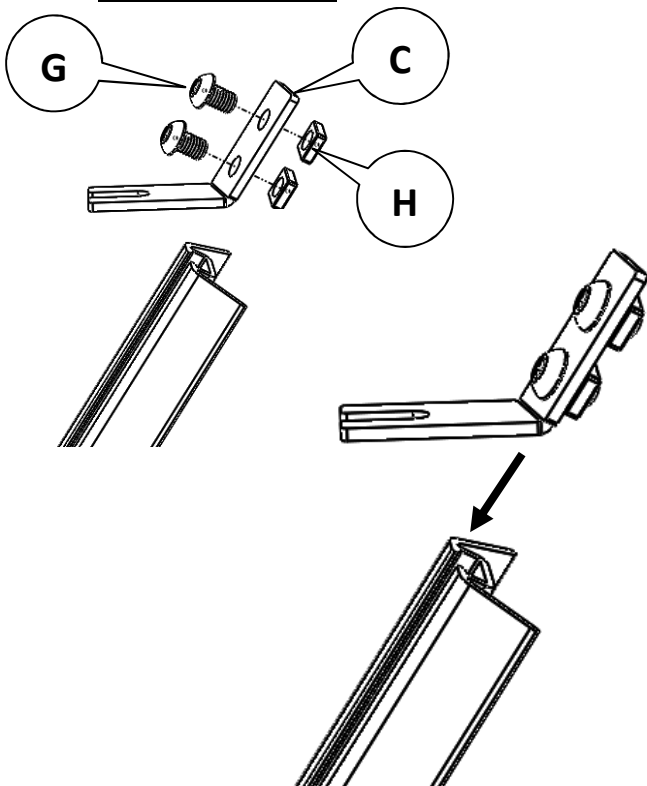

When A-Pillar bracket is mounted the windshield will not be able to be folded down. Brackets C and D are not intended for a Light Bar.

7

Install bolt (G) through the endcap (E) and install nut (H) on the other side. Slide nut into channel until the endcap is flush with the top of the bracket and fully tighten hardware.

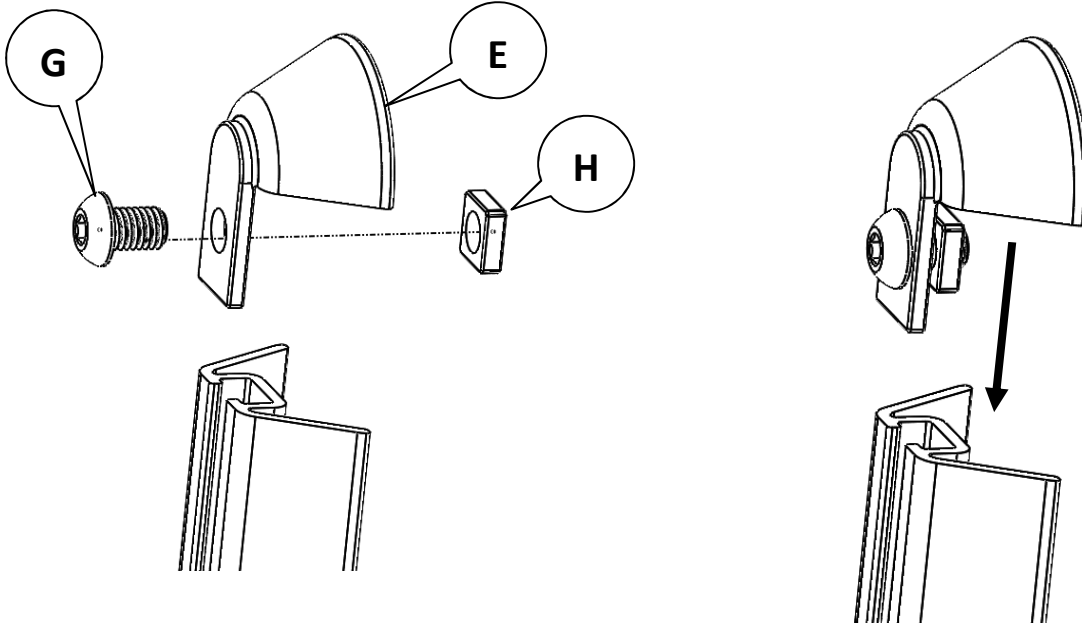

Repeat Steps 4-7 on Passenger side Using bracket B instead of A.