



300 HUEY LENARD LOOP | WEST MONROE | LA 71292
 OFFICE: 318-397-3000 | FAX: 318-397-3040
 SERVICE & TECH SUPPORT: 800-551-4955
 SUPERLIFT.COM



2018-2019 JEEP WRANGLER 4 Inch Lift Kits INSTALLATION INSTRUCTIONS

Engineered for 4WD Models.

Fits: 2018-2019 Jeep Wrangler JL Sport 2-Door 4WD
 2018-2019 Jeep Wrangler JL Sport S 2-Door 4WD
 2018-2019 Jeep Wrangler JL Rubicon 2-Door 4WD
 2018-2019 Jeep Wrangler JL Unlimited Sport 4-Door 4WD
 2018-2019 Jeep Wrangler JL Unlimited Sport S 4-Door 4WD
 2018-2019 Jeep Wrangler JL Unlimited Sahara 4-Door 4WD
 2018-2019 Jeep Wrangler JL Unlimited Rubicon 4-Door 4WD
 2019 Jeep Wrangler JL Unlimited Moab 4-Door 4WD



CAUTION: MAKE SURE YOU HAVE THE CORRECT LIFT FOR YOUR VEHICLE:

Double check the Year, Make, Model, Lift Height and KIT Part Numbers.

NOTE: Prior to beginning the installation, OPEN the Boxes and CHECK the Included Components Compared to the Parts Breakdown. Check all parts and hardware in the box with the parts list below. Be sure you have all needed parts and know where they install.

If you find a packaging error, contact SUPERLIFT directly. Do not contact the dealer where the system was originally purchased. You will need the control number from each box when calling; this number is located at the bottom of the part number label and to the right of the bar code.

- ① Link Arms, Rear Lower, DR & PA Side
- ② Coil Spring, Rear, PA Side
- ③ Coil Spring, Rear DR Side
- ④ Bump Stops, Rear, DR & PA Side
- ⑤ Sway Bar Links, Rear, DR & PA Side
- ⑥ Coil Spring, Front, PA Side
- ⑦ Sway Bar Links, Front, DR & PA Side
- ⑧ Track Bar Relocation Bracket, Rear
- ⑨ Shock Spacers, Rear, DR & PA Side
- ⑩ Coil Spring, Front, DR Side
- ⑪ Link Arms, Front Lower, DR & PA Side
- ⑫ Bump Stops, Front, DR & PA Side
- ⑬ Shock Spacers, Front, DR & PA Side
- ⑭ Track Bar Relocation Bracket, Front

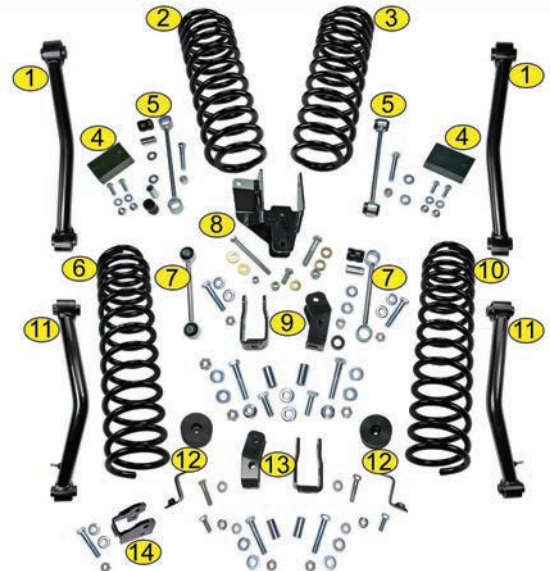

NOTE: K186 4 Inch Lift Shown

- ① Link Arms, Rear Lower, DR & PA Side
- ② Coil Spring, Rear, PA Side
- ③ Coil Spring, Rear DR Side
- ④ Bump Stops, Rear, DR & PA Side
- ⑤ Sway Bar Links, Rear, DR & PA Side
- ⑥ Coil Spring, Front, PA Side
- ⑦ Sway Bar Links, Front, DR & PA Side
- ⑧ Track Bar Relocation Bracket, Rear
- ⑨ Track Bar Relocation Bracket, Front
- ⑩ Coil Spring, Front, DR Side
- ⑪ Link Arms, Front Lower, DR & PA Side
- ⑫ Bump Stops, Front, DR & PA Side
- ⑬ FOX Shocks, Rear, DR & PA Side
- ⑭ FOX Shocks, Front, DR & PA Side



NOTE: K186F 4 Inch Lift Shown

How to Read the Kit Breakdown Charts:

The 'K KIT BREAKDOWN' lists the Part Numbers, Quantities & Part Description of the Boxes that are included in the K KIT. The 'KIT BREAKDOWN' lists Part Numbers, Quantities & Part Description of the Individual Components & Hardware Bags that are included in Each Box. The 'HARDWARE BREAKDOWN' lists the Part Numbers, Quantities & Part Description of the Individual Components.

4" K KIT BREAKDOWN - Jeep Wrangler JLU 4-Door SINGLE RATE COILS					
Kit Part Number K176 - 4" Coils with Shock Spacers			Kit Part Number K176F - 4" Coils with FOX Shocks		
Part Number	Qty.	Part Description	Part Number	Qty.	Part Description
586	1	4" Coil Springs, Front	586	1	4" Coil Springs, Front
594	1	4" Coil Springs, Rear	594	1	4" Coil Springs, Rear
5825	1	Shock Spacers, Bump Stops, Sway Bar Links & Track Bar Brackets	5802	1	FOX Shocks, Front & Rear
5833	1	Lower Link Arms, Fixed, Front & Rear	5828	1	Bump Stops, Sway Bar Links, Track Bar Brackets
			5833	1	Lower Link Arms, Fixed, Front & Rear

4" K KIT BREAKDOWN - Jeep Wrangler JLU 4-Door DUAL RATE COILS					
Kit Part Number K184 - 4" Dual Rate Coils with Shock Spacers			Kit Part Number K184F - 4" Dual Rate Coils with FOX Shocks		
Part Number	Qty.	Part Description	Part Number	Qty.	Part Description
588	1	4" Dual Rate Coil Spring, Front	588	1	4" Dual Rate Coil Spring, Front
597	1	3.5" Dual Rate Coil Spring, Rear	597	1	3.5" Dual Rate Coil Spring, Rear
5825	1	Shock Spacers, Bump Stops, Sway Bar Links & Track Bar Brackets	5802	1	FOX Shocks, Front & Rear
5833	1	Lower Link Arms, Fixed, Front & Rear	5828	1	Bump Stops, Sway Bar Links, Track Bar Brackets
			5833	1	Lower Link Arms, Fixed, Front & Rear

4" K KIT BREAKDOWN - Jeep Wrangler JL 2-Door DUAL RATE COILS					
Kit Part Number K186 - 4" Dual Rate Coils with Shock Spacers			Kit Part Number K186F - 4" Dual Rate Coils with FOX Shocks		
Part Number	Qty.	Part Description	Part Number	Qty.	Part Description
598	1	4" Dual Rate Coil Spring, Front	598	1	4" Dual Rate Coil Spring, Front
599	1	3.5" Dual Rate Coil Spring, Rear	599	1	3.5" Dual Rate Coil Spring, Rear
5825	1	Shock Spacers, Bump Stops, Sway Bar Links & Track Bar Brackets	5802	1	FOX Shocks, Front & Rear
5833	1	Lower Link Arms, Fixed, Front & Rear	5828	1	Bump Stops, Sway Bar Links, Track Bar Brackets
			5833	1	Lower Link Arms, Fixed, Front & Rear

4" KIT BREAKDOWN					
Kit Part Number 586			Kit Part Number 5825		
Part Number	Qty.	Part Description	Part Number	Qty.	Part Description
01-586	1	4" Coil Spring, Front Driver Side	55-01-5825	1	Track Bar Bracket, Front
02-586	1	4" Coil Spring, Front Passenger Side	55-13-5825	2	Shock Spacer, Front
Kit Part Number 594			55-14-5825	2	Shock Spacer, Rear
Part Number	Qty.	Part Description	55-17-5825	2	Bump Stop, Front
01-594	1	3.5" Coil Spring, Rear Driver Side	55-18-5825	2	Bump Stop, Rear
02-594	1	3.5" Coil Spring, Rear Passenger Side	55-16-5825	2	Sway Bar Link, Front
Kit Part Number 588			55-31-5825	1	Rear Track Bar Bracket
Part Number	Qty.	Part Description	44-17-5040	2	Sway Bar Link, Rear
01-588	1	4" Dual Rate Coil Spring, Front Driver Side	77-5800	1	Hardware Bag, Shock Spacers
02-588	1	4" Dual Rate Coil Spring, Front Passenger Side	77-5801	1	Hardware Bag, Sway Bar Links
Kit Part Number 597			77-5802	1	Hardware Bag, Bump Stops
Part Number	Qty.	Part Description	77-5824	1	Hardware Bag, Track Bar Bracket, Rear
01-597	1	3.5" Dual Rate Coil Spring, Rear Driver Side	77-5825	1	Hardware Bag, Track Bar Bracket, Front
02-597	1	3.5" Dual Rate Coil Spring, Rear Passenger Side	Kit Part Number 5828		
Kit Part Number 598			Part Number	Qty.	Part Description
Part Number	Qty.	Part Description	55-01-5825	1	Track Bar Bracket, Front
01-598	1	4" Dual Rate Coil Spring, Front Driver Side	55-17-5825	2	Bump Stop, Rear
02-598	1	4" Dual Rate Coil Spring, Front Passenger Side	55-18-5825	2	Bump Stop, Rear
Kit Part Number 599			55-16-5825	2	Sway Bar Link, Front
Part Number	Qty.	Part Description	55-31-5825	1	Rear Track Bar Bracket
01-599	1	3.5" Dual Rate Coil Spring, Rear Driver Side	44-17-5040	2	Sway Bar Link, Rear
02-599	1	3.5" Dual Rate Coil Spring, Rear Passenger Side	77-5801	1	Hardware Bag, Sway Bar Links
Kit Part Number 5802			77-5802	1	Hardware Bag, Bump Stops
Part Number	Qty.	Part Description	77-5824	1	Hardware Bag, Rear
985-24-177	2	FOX Shocks, Front	77-5825	1	Hardware Bag, Track Bar Bracket, Front
985-24-178	2	FOX Shocks, Rear	Kit Part Number 5833		
			Part Number	Qty.	Part Description
			55-10-5825	1	Link Arm, Front Lower Driver
			55-11-5825	1	Link Arm, Front Lower Passenger
			55-12-5825	2	Link Arm, Rear Lower Driver & Passenger

HARDWARE BAG BREAKDOWN					
Kit Part Number 77-5800			Kit Part Number 77-5802		
Part Number	Qty.	Part Description	Part Number	Qty.	Part Description
12C5FN	2	1/2" Nut, Flange Coarse Thread	38C5FN	4	3/8" Flange Nut, Coarse Thread
12C5NN	4	1/2" Nut, Nyloc Coarse Thread	38SW	6	3/8" Washer, SAE
12SW	10	1/2" Washer, SAE	38X134C8CS	6	3/8" x 1-3/4" Bolt, Coarse Thread
12X112C8CS	2	1/2" x 1-1/2" Bolt, Coarse Thread	55-08-5800	2	3/8" Nut, Tab
12X312C8CS	4	1/2" x 3-1/2" Bolt, Coarse Thread			
24-5704	4	Sleeve, 0.75" OD x 0.50" ID x 1.50" Long	Kit Part Number 77-5824		
38C5FN	2	3/8" Flange Nut, Coarse Thread	Part Number	Qty.	Part Description
38SW	2	3/8" Washer, SAE	716X5C8CS	1	7/16" x 5", Course Thread, Grade 8
38X114C8CS	2	3/8" x 1-1/4" bolt, Coarse Thread	716C5NN	1	7/16" Nyloc Nut, Course Thread
			716UW	2	7/16" USS Flat Washer
Kit Part Number 77-5801			916X3C8CS	1	9/16" x 3", Course Thread, Grade 8
Part Number	Qty.	Part Description	916C5NN	1	9/16" Nyloc Nut, Course Thread
01-60418	8	Bushing, Hourglass	916SW	2	9/16" SAE Flat Washer
24-5704	8	Sleeve, 0.75" OD x 0.50" ID x 1.50" Long	12X114C8CS	1	1/2" x 1-1/4", Course Thread, Grade 8
			12C5NN	1	1/2" Nyloc Nut, Course Thread
Kit Part Number 77-5801A			12SW	1	1/2" SAE Flat Washer
Part Number	Qty.	Part Description	Kit Part Number 77-5825		
12MNN	4	12mm Nut, Nyloc Coarse Thread	Part Number	Qty.	Part Description
12MFW	8	12mm Flat Washer	916X312C8CS	2	9/16" x 3-1/4" Bolt, Coarse Thread
12MX1.75X70CS	2	12mm x 70mm Bolt, 1.75 Coarse Thread	916SW	2	9/16" Washer, SAE
12MX1.75X80CS	2	12mm x 80mm Bolt, 1.75 Coarse Thread	55-15-5825	1	9/16" Tab Nut
			02-5825	1	Sleeve, 0.875" OD x 0.625" ID x 1.5625" Long

INTRODUCTION BEFORE INSTALLATION...

Installation requires a professional mechanic. In addition to these instructions, professional knowledge of disassembly / reassembly procedures and post installation checks must be known.

PRIOR to beginning, inspect the vehicles steering, driveline, and brake systems, paying close attention to the suspension link arms and bushings, sway bars and bushings, tie rod ends, pitman arm, idler arm, ball joints and wheel bearings. Also check the steering sector-to-frame and all suspension-to-frame attaching points for stress cracks. The overall vehicle must be in excellent working condition; repair or replace all worn parts.

Read instructions several times before starting.

Read each step completely as you go.

Be sure you have all needed parts and know where they install.

NOTES:

- Front end alignment is necessary.
- Tool and Wrench/Socket size is given in brackets [] after each appropriate step.
- A foot-pound torque reading is given in parenthesis () after each appropriate fastener.
- Always wear safety glasses when using power tools.
- Prior to attaching components, be sure all mating surfaces are free of grit, grease, excessive undercoating, etc.
- Do not fabricate any components to gain additional suspension height.
- A factory service manual should be on hand for reference.
- Due to payload options and initial ride height variances, the amount of lift is a 'base figure'. Final ride height dimensions may vary in accordance to original vehicle stance.

BEFORE YOU DRIVE...

Check all fasteners for proper torque. Check to ensure for adequate clearance between all rotating, mobile, fixed, and heated members. Verify clearance between exhaust and brake lines, fuel lines, fuel tank, floor boards and wiring harness. Check steering components for clearance.

Test and inspect brake system. Perform steering sweep to ensure front brake hoses have adequate slack and do not contact any rotating, mobile or heated members. Inspect rear brake hoses at full extension for adequate slack. Failure to perform hose check/replacement may result in component failure.

Perform head light check and adjustment.

⚠️ WARNING: It is the ultimate buyer’s responsibility to have all bolts / nuts checked for tightness after the first 100 miles and then every 1000 miles. The steering, suspension and driveline systems, plus wheel alignment should be inspected by a qualified professional mechanic at least every 3000 miles.

TIRES & WHEELS...

Larger rim and tire combinations may increase leverage on suspension, steering, and related components. When selecting combinations larger than OE, consider the additional stress you could be inducing on the OE and related components.

⚠️ NOTE: Stock 17", 18" and 20" Wheels Will Fit back on the vehicle once this suspension system is installed.

⚠️ WARNING: ANY larger or wider tire & wheel combination other than listed Will Require Vehicle Trimming.

4 Inch - TIRE SIZE SPECIFICATIONS			
Tire Size	Wheel	Backspacing (INCH)	Offset (MM)
35 x 12.50 R17	17 x 9	4.00 - 4.75	-24mm -12mm
315/70R17	17 x 9	4.00 - 4.75	-24mm -12mm
35 x 12.50 R18	18 x 9	4.00 - 4.75	-24mm -12mm
315/70R18	18 x 9	4.00 - 4.75	-24mm -12mm
35 x 12.50 R20	20 x 9	4.00 - 4.75	-24mm -12mm
315/60 R20	20 x 9	4.00 - 4.75	-24mm -12mm

Maximum BS/Offset Listed

RUBICON ONLY 4 Inch - TIRE SIZE SPECIFICATIONS			
Tire Size	Wheel	Backspacing (INCH)	Offset (MM)
37 x 12.50 R17	17 x 9	4.00 - 4.75	-24mm -12mm
37 x 12.50 R18	18 x 9	4.00 - 4.75	-24mm -12mm
37 x 12.50 R20	20 x 9	4.00 - 4.75	-24mm -12mm
37 x 12.50 R22	22 x 9	4.00 - 4.75	-24mm -12mm
325/55 R22	22 x 9	4.00 - 4.75	-24mm -12mm
315/50 R24	24 x 9	4.00 - 4.75	-24mm -12mm

Maximum BS/Offset Listed

IMPORTANT DISCLAIMER: The provided tire/wheel fitments are approximate. Actual dimensions of a given tire size can vary considerably from one brand to another. Manufacturers’ wheel offset and backspacing measurement points are not always consistent. Backspacing greatly impacts tire-to-fender clearance when turning. Wheel width and backspacing influence whether the tires protrude past the fenders, and to what extent. Considering these important factors, we recommend that you fit-check your tire/wheel selection prior to purchasing.

TOOLS & TECH...

The chart is a listing of the main tools need to install this lift kit system.

We have also included a **Tech Tip** noted by this icon  **TECH TIP** to help if we have found a quicker or easier way to accomplish a task in the steps.

Tools			
Miscellaneous Tools		Wrench / Socket Sizes	
Floor Jacks	Jack Stands	Standard	Metric
Adjustable Pliers		9/16"	8mm 19mm
Torque Wrench		5/8"	13mm 21mm
Flathead Screwdriver		3/4"	15mm 22mm
Ball Peen Hammer		13/16"	18mm 24mm
Drill	1/2" Drill Bit	7/8"	
Plastic Fastener Removal Tool			
Tie Rod Puller Tool			6mm Allen

TORQUE SPECIFICATIONS					
STANDARD			METRIC		
Size	Grade 5	Grade 8	Size	Grade 8.8	Grade 10.9
5/16"	15 ft/lbs.	20 ft/lbs.	6mm	5 ft/lbs.	9 ft/lbs.
3/8"	30 ft/lbs.	35 ft/lbs.	8mm	18 ft/lbs.	23 ft/lbs.
7/16"	45 ft/lbs.	60 ft/lbs.	10mm	32 ft/lbs.	45 ft/lbs.
1/2"	65 ft/lbs.	90 ft/lbs.	12mm	55 ft/lbs.	75 ft/lbs.
9/16"	95 ft/lbs.	130 ft/lbs.	14mm	85 ft/lbs.	12 ft/lbs.
5/8"	135 ft/lbs.	175 ft/lbs.	16mm	130 ft/lbs.	165 ft/lbs.
3/4"	185 ft/lbs.	280 ft/lbs.	18mm	170 ft/lbs.	240 ft/lbs.

STEP	PART NUMBER	QTY. PER KIT	DESCRIPTION	NEW ATTACHING HARDWARE	QTY. PER BRACKET	HARDWARE BAG NUMBER
13	55-17-5825	2	Bump Stop, Front	3/8" x 1-1/4" Bolt, Coarse Thread	1	77-5802
				55-08-5800 - 3/8" Nut, Tab	1	
				3/8" Washer, SAE	1	
13	01-586	1	4" Coil Spring, Front Driver Side			
	02-586	1	4" Coil Spring, Front Passenger Side			
OR						
13	01-588	1	4" Dual Rate Coil Spring, Front Driver Side			
	02-588	1	4" Dual Rate Coil Spring, Front Passenger Side			
OR						
13	01-598	1	4" Dual Rate Coil Spring, Front Driver Side			
	02-598	1	4" Dual Rate Coil Spring, Front Passenger Side			
14	55-10-5825	1	4" Link Arm, Front Lower Driver			
	55-11-5825	1	4" Link Arm, Front Lower Passenger			
16	55-13-5825	2	Shock Spacer, Front	24-5704 Sleeve, 0.75" OD x 0.50" ID x 1.50" Long	1	77-5800
				3/8" x 1" Bolt, Coarse Thread	1	
				1/2" x 3-1/2" Bolt, Coarse Thread	1	
				1/2" Washer, SAE	2	
				3/8" Flange Nut, Coarse Thread	1	
				1/2" Nut, Nyloc Coarse Thread	1	
				3/8" Washer, SAE	1	
OR						
17	985-24-177	2	FOX Shocks, Front			
23	55-16-5825	2	Sway Bar Link, Front	01-60418 - Bushing, Hourglass	2	77-5801
				24-5704 - Sleeve, 0.75" OD x 0.50" ID x 1.50" Long	2	
				12mm x 80mm Bolt, 1.75 Coarse Thread	1	77-5801A
				12mm Flat Washer	2	
				12mm Nut, Nyloc Coarse Thread	1	
24	55-01-5825	1	Track Bar Bracket, Front	9/16" x 3-1/4" Bolt, Coarse Thread	2	77-5825
				9/16" Washer, SAE	2	
				55-15-5825 - 9/16" Tab Nut	1	
				02-5825 - Sleeve, 0.875" OD x 0.625" ID x 1.5625" Long	1	
39	55-12-5825	2	4" Link Arm, Rear Lower Driver & Passenger			
40	55-18-5825	2	Bump Stop, Rear	3/8" x 1-3/4" Bolt, Coarse Thread	2	77-5802
				3/8" Washer, SAE	4	
				3/8" Flange Nut, Coarse Thread	2	
41	01-594	1	3.5" Coil Spring, Rear Driver Side			
	02-594	1	3.5" Coil Spring, Rear Passenger Side			
OR						
41	01-597	1	3.5" Dual Rate Coil Spring, Rear Driver Side			
	02-597	1	3.5" Dual Rate Coil Spring, Rear Passenger Side			
OR						
41	01-599	1	3.5" Dual Rate Coil Spring, Rear Driver Side			
	02-599	1	3.5" Dual Rate Coil Spring, Rear Passenger Side			
42	55-14-5825	2	Shock Spacer, Rear	24-5704 - Sleeve, 0.75" OD x 0.50" ID x 1.50" Long	1	77-5800
				1/2" x 1-1/2" Bolt, Coarse Thread	1	
				1/2" Washer, SAE	3	
				1/2" Nut, Flange Coarse Thread	1	
				1/2" x 3-1/2" Bolt, Coarse Thread	1	
				1/2" Nut, Nyloc Coarse Thread	1	
OR						
43	985-24-178	2	FOX Shocks, Rear			
44	44-17-5050	2	Sway Bar link, Rear	01-60418 - Bushing, Hourglass	2	77-5801
				24-5704 - Sleeve, 0.75" OD x 0.50" ID x 1.50" Long	2	
				12mm x 70mm Bolt, 1.75 Coarse Thread	1	77-5801A
				12mm Flat Washer	2	
				12mm Nut, Nyloc Coarse Thread	1	
48	55-31-5825	1	Rear Track Bar Bracket	7/16" x 5", Course Thread, Grade 8	1	77-5824
				7/16" Nyloc Nut, Course Thread	1	
				7/16" USS Flat Washer	2	
				9/16" x 3", Course Thread, Grade 8	1	
				9/16" Nyloc Nut, Course Thread	1	
				9/16" SAE Flat Washer	2	
				1/2" x 1-1/4", Course Thread, Grade 8	1	
				1/2" Nyloc Nut, Course Thread	1	
				1/2" SAE Flat Washer	1	

NOTE: Use the check-off box found at each step to help you keep your place. Two denotes that one check-off box is for the Driver Side (Left) and one is for the Passenger Side (Right). Unless otherwise noted, always start with the Driver Side.

FRONT DISASSEMBLY

NOTE: Save ALL factory components and hardware for reuse, unless noted.

TECH TIP As you uninstall OEM parts, Place the Factory Hardware Back into the Factory Location. This will save you time and make the install easier to complete.

PREPARE VEHICLE FOR FRONT...

- Disconnect the battery.
- Chock rear tires and place transmission in neutral. Raise the front of vehicle with a jack and secure a jack stand beneath each frame rail. Ease the frame down onto the stands, place transmission in Low Gear for Manual Transmission or Park for Automatic. Remove the front wheels & tires. [Lug Nuts 22mm Deep Well Socket]

REMOVE SWAY BAR LINKS...

- [Illustration 1] Remove the factory hardware from the lower sway bar link mount at the axle mount. [Bolt: 18mm, Nut: 18mm] Retain factory hardware.
- [Illustration 1] Remove the factory hardware from the upper sway bar link at the sway bar. [6mm Allen and an 18mm wrench]

DISCONNECT TRACK BAR AT AXLE MOUNT...

- [Illustration 2] Remove the factory bolt and tab nut from the track bar at the lower axle mount. [21mm] Retain the factory hardware.

RUBICONS: DISCONNECT FRONT LOCKER...

- [Illustration 3] **RUBICON Models:** The front locker must be disconnected so the wiring connectors are not over-extended.

On the Driver Side located on the 'inner' frame rail above the axle, Unplug the harness plug. Unclip the wiring harness clips from the frame. [Plastic Fastener Removal Tool]

Illustration 1

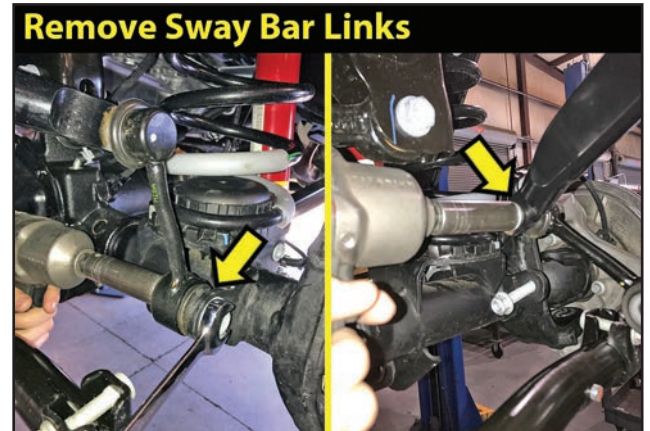

Illustration 2



Illustration 3



UNCLIP CENTER AXLE DISCONNECT (CAD)...

5. [Illustration 4] The Center Axle Disconnect or otherwise known as the CAD, must be disconnected so the wiring connectors are not over-extended.

On the Passenger Side located on the 'inner' frame rail above the axle, remove the zip tie from the wiring harness. Unclip the wiring harness clips from the frame. [Plastic Fastener Removal Tool]

At the Passenger Side axle, unplug the CAD harness. Unclip wiring clips from front axle. [Plastic Fastener Removal Tool] **NOTE:** Make sure there is adequate slack on all wires.

Illustration 4**REMOVE BRAKE LINE BRACKET...**

6. [Illustration 5] On the Driver Side & Passenger Side, remove the brake line bracket from the lower control arm. [15mm]

DISCONNECT FRONT DRIVESHAFT...

7. [Illustration 6] Make an alignment mark on the front driveshaft and front differential input yoke.

Remove the four bolts from the yoke. [15mm] Save the driveshaft hardware.

Remove the front driveshaft from the differential. Secure the driveshaft safely up and out of the way with a bungee, mechanic's wire or other method.

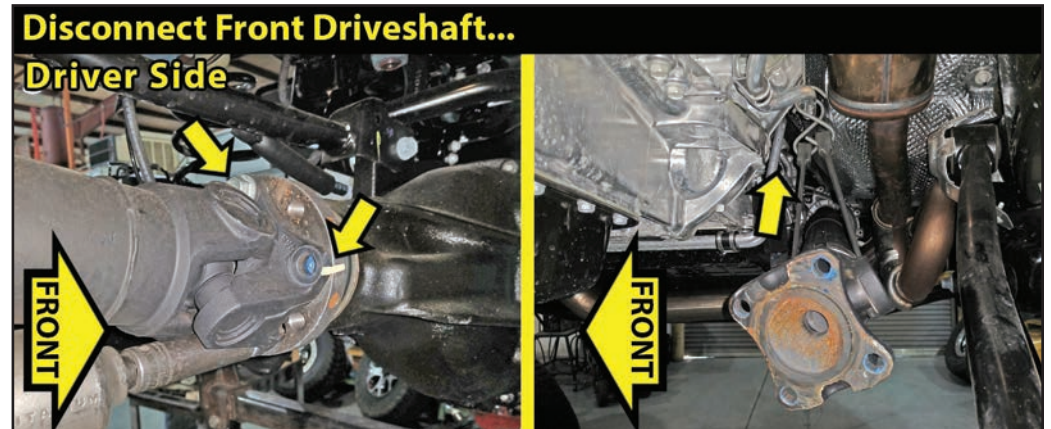
Illustration 5**Illustration 6****DISCONNECT FRONT AXLE VENT TUBE...**

8. [Illustration 7] Locate the brake line bracket attached on the Driver Side frame to the rear of the shock tower. [Plastic Fastener Removal Tool] Unclip the axle vent hose clip from the brake line bracket. Follow the vent tube up and unclip the frame attachment. [Plastic Fastener Removal Tool] Continue to follow the vent tube up and unclip from the shock tower that is behind the wheel well plastic. [Plastic Fastener Removal Tool]

Illustration 7

Disconnect Front Axle Vent Tube...

Driver Side

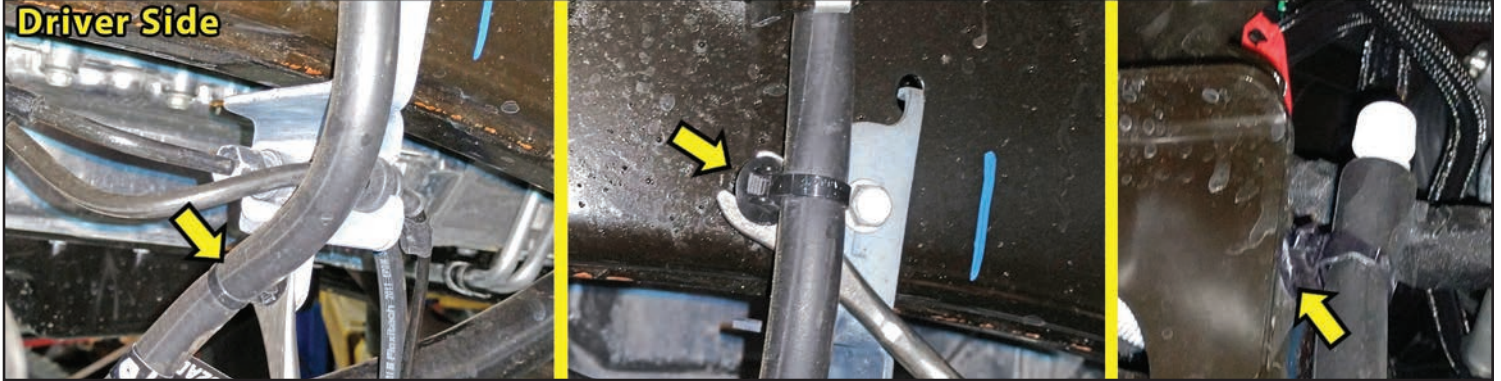

REMOVE FRONT SHOCKS...

9. □□ [Illustration 8]

⚠️ NOTE: If you are installing the Shock Spacer Kit, disconnect the Lower Shock Mount ONLY.

Disconnect the shock from the upper shock tower mount. [18mm socket]

Disconnect the shock from the lower mount at the axle. [18mm wrench \ 18mm socket]

Remove shocks. Retain the shocks and shock mount hardware.

Illustration 8

Remove Front Shocks...

Driver Side

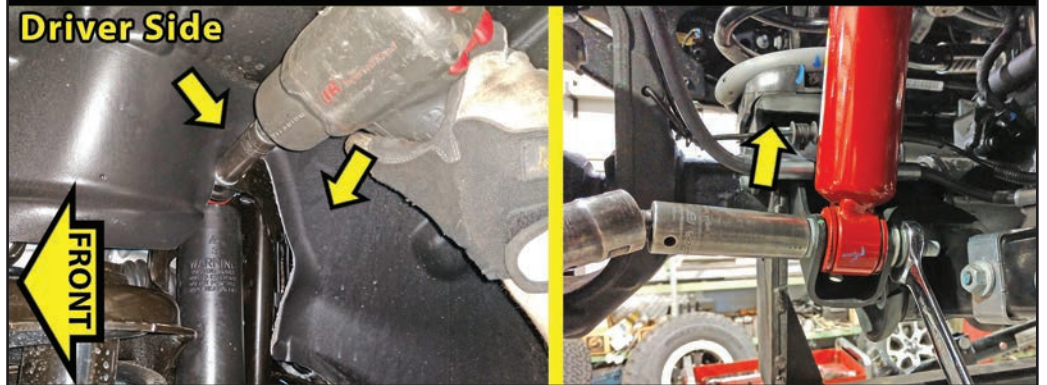

REMOVE FRONT COIL SPRINGS...

10. □□ [Illustration 9] Lower the axle enough to facilitate removing the front coil springs. Remove the coil springs.

REMOVE OEM LOWER CONTROL ARMS...

11. □□ [Illustration 10] Disconnect lower control arms from the front and rear factory mounts. [21mm & 24mm] Remove OEM lower control arms.

DISCONNECT BRAKE LINE...

12. □□ [Illustration 11] Disconnect factory brake line bracket from axle coil spring seat. [10mm] Pull bracket rearward to allow clearance. **⚠️ NOTE:** Do not over extend brake lines or ABS lines.

Illustration 9

Remove Front Coils...

Driver Side



Illustration 10

Remove OEM Lower Control Arms...



Illustration 11

Disconnect Brake Bracket...

Driver Side

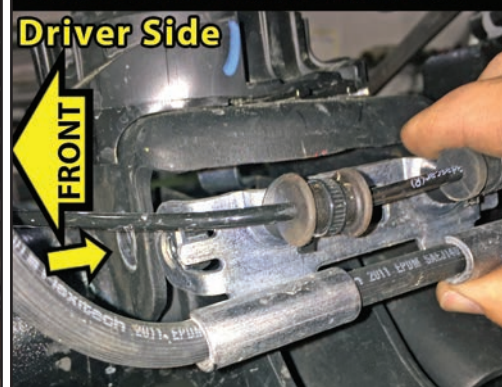

FRONT ASSEMBLY

INSTALL FRONT BUMP STOP EXTENSIONS & COIL SPRINGS...

13. □□ [Illustration 12] Locate the (2) SUPERLIFT front bump stops (#55-17-5800).

Locate Hardware Bag #77-5802. Hardware PER Side: (1) 3/8" x 1-1/4" Bolt, Coarse Thread, (1) 3/8" SAE Washer & (1) #55-08-5800 - 3/8" Nut, Tab

Insert the washer onto the 1-1/4" bolt. Insert the bolt into the top of the bump stop noted by the recessed hole.

Locate the (2) SUPERLIFT front coil springs. They are Driver and Passenger side specific.

Place the bump stop inside of the side specific coil spring. Install the front coil spring with the bump stop inside. Insert the coil spring into the upper tower first. Be sure that the coils are indexed so they seat properly then raise the axle enough to hold the coil springs in place. **TECH TIP** If the front axle cannot be lowered enough to allow the coil spring to be installed, carefully rotate the pinion up to provide more clearance for the coil installation.

The lower coil spring mount pad has a factory hole in the center. Align the bump stop bolt into the hole.

Reach under the spring mount pad and above the axle tube to start the #55-08-5800 - 3/8" tab nut onto the bump stop bolt. Tighten bump stop into place. [9/16" socket] (25)

TECH TIP On the Passenger Side, it may be necessary to remove the ABS bracket to install the tab nut. At the rear of the axle above the shock mount, remove the ABS mounting bracket. [10mm]

Once bump stop spacer is tight, reinstall ABS line mounting bracket onto axle. [10mm]

Illustration 12

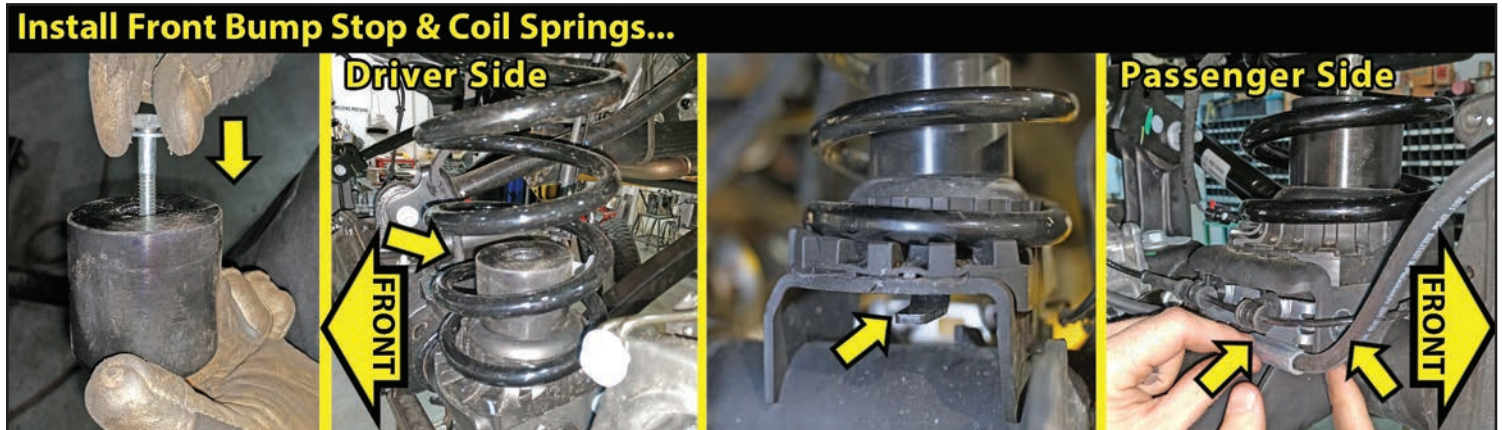

INSTALL LOWER CONTROL ARMS...

14. □□ [Illustration 13] Locate the SUPERLIFT front lower control arms: #55-10-5825, Driver & #55-11-5825, Passenger. **NOTE:** These are side specific. The Part Number is stamped into a welded tab located on the inside of the lower control arm toward the rear mount. The brake bracket mounting stud goes toward the front & points toward the outside of the vehicle.

Install the new lower control arm into the front & rear mounts using the factory hardware with the bolt pointing inward. [21mm & 24mm]

Illustration 13

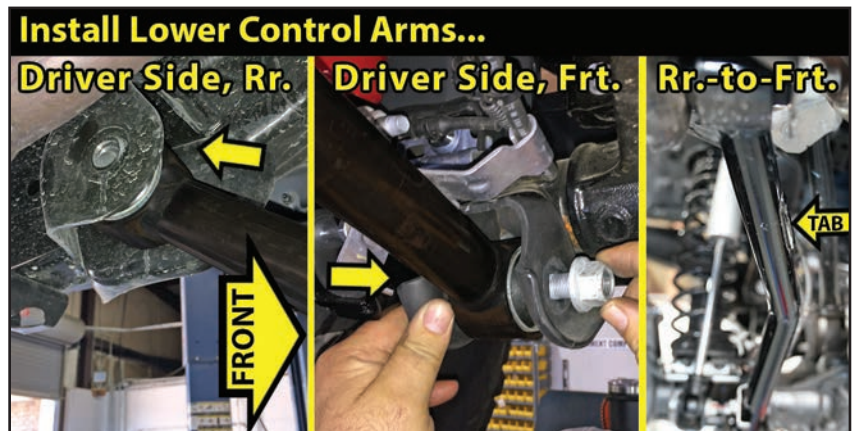

RECONNECT BRAKE LINE...

15. □□ [Illustration 14] Reconnect factory brake line bracket from axle coil spring seat. [10mm]

INSTALL FRONT SHOCK SPACER INSTALL...

NOTE: IF you are installing the FOX front shocks, Proceed to Step 17.

16. □□ [Illustration 15] Locate the (2) SUPERLIFT front shock spacers (#55-13-5825). They are not side specific. Locate Hardware Bag #77-5800. Hardware PER Side: (1) #24-5704 Sleeve, 0.75" OD x 0.50" ID x 1.50" Long, (1) 3/8" x 1-1/4" Bolt, Coarse Thread, (1) 3/8" SAE Washer, (1) 3/8" Flange Nut, Coarse Thread (1) 1/2" x 3-1/2" Bolt, Coarse Thread, (1) 1/2" SAE Washer & (1) 1/2" Nyloc Nut, Coarse Thread.

Swing the shock rearward and up out of the way. Place the SUPERLIFT front shock spacer on the factory shock mount with pointing rearward and up. Insert the 3/8" SAE washer onto the 3/8" x 1-1/4" bolt. Insert the bolt/washer up through the bottom hole of the bracket/factory mount. Install 3/8" flange nut. [9/16 wrench / 9/16 socket]

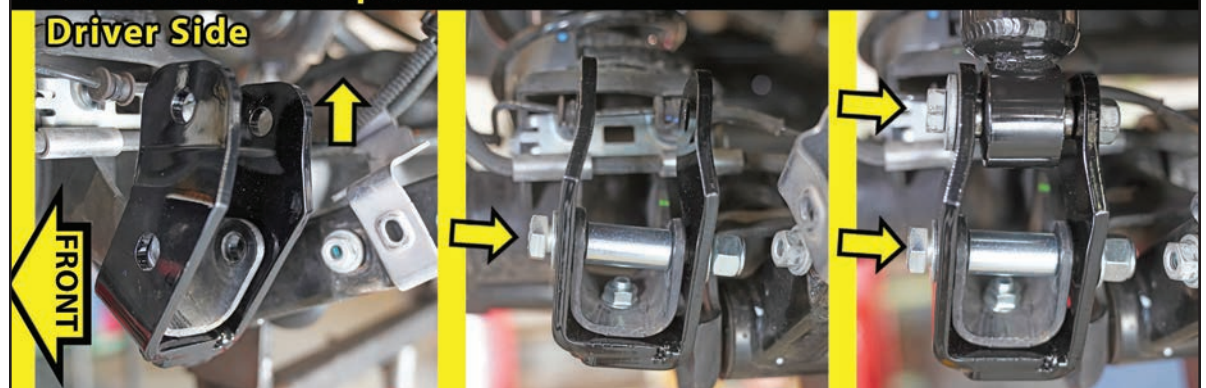
Illustration 15**Install Front Shock Spacer...**

TECH TIP The bottom hole of the factory shock mount may have to be deburred before the bolt is installed easily. Use a 3/8" drill bit to deburr the hole if needed.

Attach 1/2" SAE Washer onto the 1/2" x 3-1/2" bolt. Insert the bolt pointing inward into the shock spacer/factory shock mount. Attach #24-5704 sleeve. Continue bolt through spacer/shock mount, then attach 1/2" SAE washer & 1/2" Nyloc nut. Snug tighten only. [3/4" wrench / 3/4" socket]

Swing factory shock into place and align with the upper hole of the spacer. Install shock with factory hardware with the bolt pointing inward. Snug tighten only. [18mm wrench \ 18mm socket]

Shocks will be tightened completely when the vehicle is set on the ground.

FOX SHOCK INSTALL...

17. □□ [Illustration 16] Locate the #985-24-177 FOX Shocks. Install the FOX front shocks using the factory hardware at the upper shock tower mount. Tighten the upper hardware until bushings swell slightly. [18mm socket]

NOTE: The upper shock mount has a factory fixed nut in place on the frame. Be careful not to dislodge nor over tighten this nut.

Attach the shock at the lower mount at the axle using the factory hardware. [18mm wrench \ 18mm socket]

Snug tighten only. Shocks will be tightened completely when the vehicle is set on the ground.

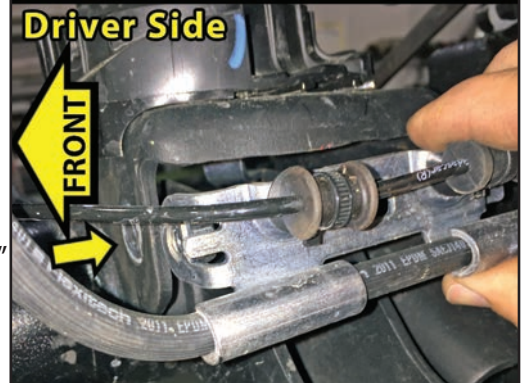
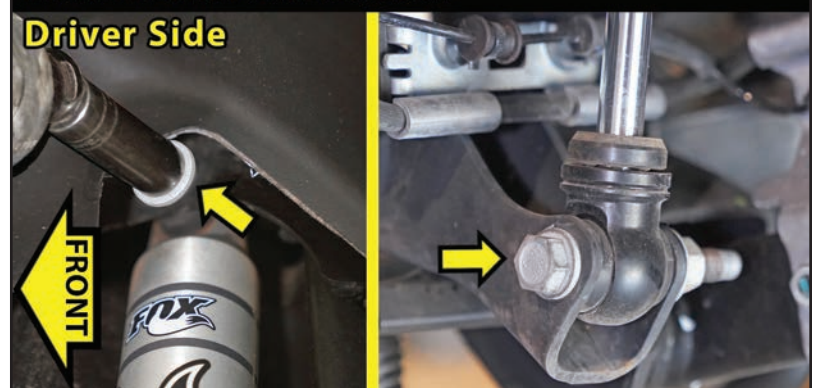
Illustration 14**Reconnect Brake Bracket...****Illustration 16****Install Front FOX Shocks...**

ATTACH BRAKE LINE BRACKET TO LOWER CONTROL ARM...

18. □ □ [Illustration 17] On the Driver Side & Passenger Side, attach the brake line bracket to the lower control arm using the factory flange nut. [15mm]

REATTACH FRONT AXLE VENT TUBE...

19. □ [Illustration 18] Locate the brake line bracket attached on the Driver Side frame to the rear of the shock tower. Re-clip the axle vent hose clip to the brake line bracket. Follow the vent tube up and re-clip to the frame attachment. Continue to follow the vent tube up and re-clip to hole on the shock tower.

Illustration 17**Illustration 18****REATTACH FRONT DRIVESHAFT...**

20. □ [Illustration 19] Locate the front driveshaft factory bolts. Apply thread locking compound to the factory bolt threads before installation. Align mark on the front driveshaft and front differential input yoke, reconnect the front driveshaft to the front differential. [15mm] (81)

TECH TIP With the bolts in place, use a pry bar to keep the driveshaft from turning while you tighten & torque into place.

RUBICONS: RECONNECT FRONT LOCKER...

21. □ [Illustration 20] **RUBICON Models:** On the Driver Side located on the 'inner' frame rail above the axle, re-clip the plug wiring harness together & re-clip back to the frame. Reconnect so the wiring connectors are not over-extended.

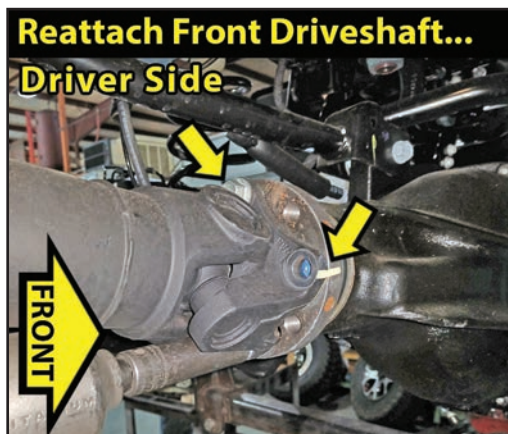
Illustration 19**Illustration 20****RECLIP CENTER AXLE DISCONNECT (CAD)...**

22. □ [Illustration 21] At the Passenger Side axle, re-plug the CAD harness. On the Passenger Side on the 'inner' frame rail above the axle, re-clip the plug wiring harness together & re-clip back to the frame. Reconnect so the wiring connectors are not over-extended.

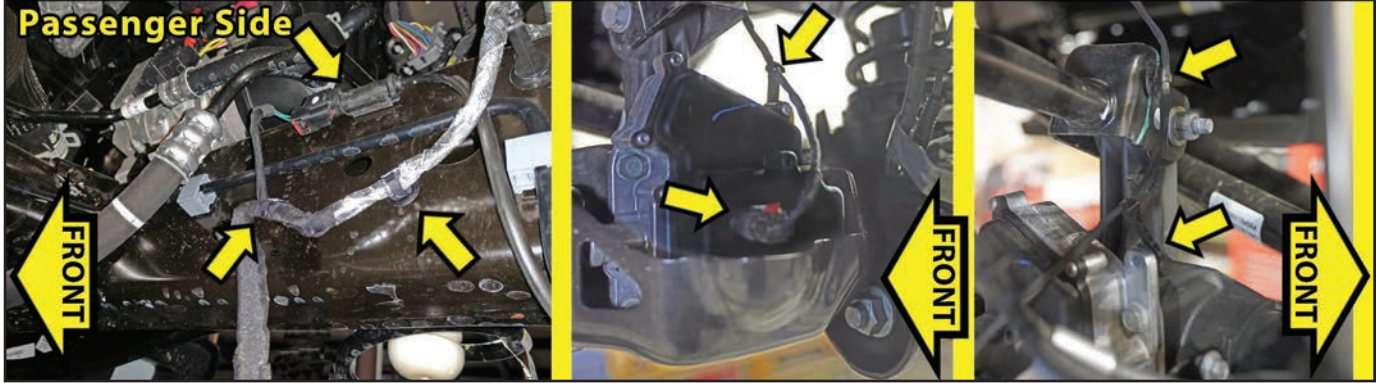
Illustration 21**Reclip Center Axle Disconnect (CAD)...****Passenger Side****INSTALL FRONT SWAY BAR LINKS...**

23. □ □ [Illustration 22] Locate the (2) SUPERLIFT front sway bar links (#55-16-5825). **NOTE:** These supplied front sway bar links are shorter than the supplied rear sway bar links.

Locate Hardware Bag #77-5801 & #77-5801A. Hardware PER Side: (2) 01-60418 - Bushing, Hourglass, (2) #24-5704 - Sleeve, 0.75" OD x 0.50" ID x 1.50" Long, (1) 12mm x 80mm Bolt, Coarse Thread, (2) 12mm Washer & (1) 12mm Nut, Nyloc Coarse Thread.

Lightly grease and install/press the hourglass shaped bushing and 0.50" ID sleeve into each end of the sway bar link end. **NOTE:** ONLY attach the upper sway bar link mount to the sway bar at this time. The lower mount will be attached to the new track bar bracket.

Attach 12mm Washer onto the 12mm x 80mm bolt. Insert the bolt pointing inward into the new sway bar link.

Continue bolt through sway bar, then attach 12mm washer & 12mm Nyloc nut.

Snug tighten only. [19mm wrench / 19mm socket]

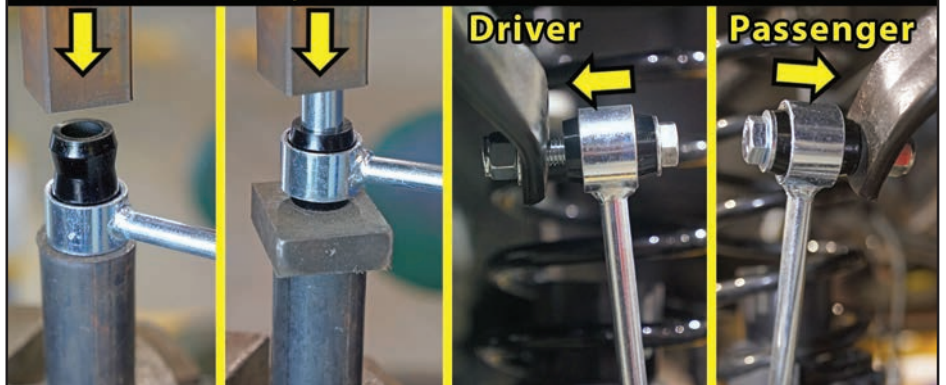
Illustration 22**Install Front Sway Bar Links...****INSTALL TRACK BAR AT AXLE MOUNT...**

24. □ [Illustration 23] Locate the SUPERLIFT track bar bracket (#55-01-5825).

Locate Hardware Bag #77-5825. Hardware: (2) 9/16" x 3-1/4" Bolt, Coarse Thread, (2) 9/16" Washer, SAE, (1) #55-15-5825 - 9/16" Tab Nuts & (1) #02-5825 - Sleeve, 0.875" OD x 0.625" ID x 1.5625" Long.

Install #55-01-5825 track bar bracket. The flat plate side goes to the front.

Use the factory hardware, attach the lower sway bar link mount through the axle mount and into the track bar bracket. [Bolt: 18mm & tab nut] Start the bolt/nut, but do not completely tighten at this time.

Insert the #02-5825 - Sleeve, 0.875" OD x 0.625" ID x 1.5625" Long into the bracket. Attach the 9/16" washer onto the 9/16" x 3-1/4" bolt. Insert the bolt point rearward into the lower hole on the bracket, through the sleeve and continue the bolt out the back. Attach the 9/16 tab nut and tighten. [3/4"]

Align the track bar into the track bar bracket at the upper hole. Attach the 9/16" washer onto the 9/16" x 3-1/4" bolt. Insert the bolt point rearward into the upper hole on the bracket, through the track bar and continue the bolt out the back. Attach the 9/16 tab nut and tighten. [3/4"]

Sway bar lower link mount and track bar will be torqued when on the ground.

TECH TIP A ratchet strap will help position the track bar. Attach the ratchet strap to the track bar upper frame mount & to the lower axle mount. Ratchet the strap to align the track bar with the mount hole.

Illustration 23

Install Front Track Bar Bracket...

Driver Side

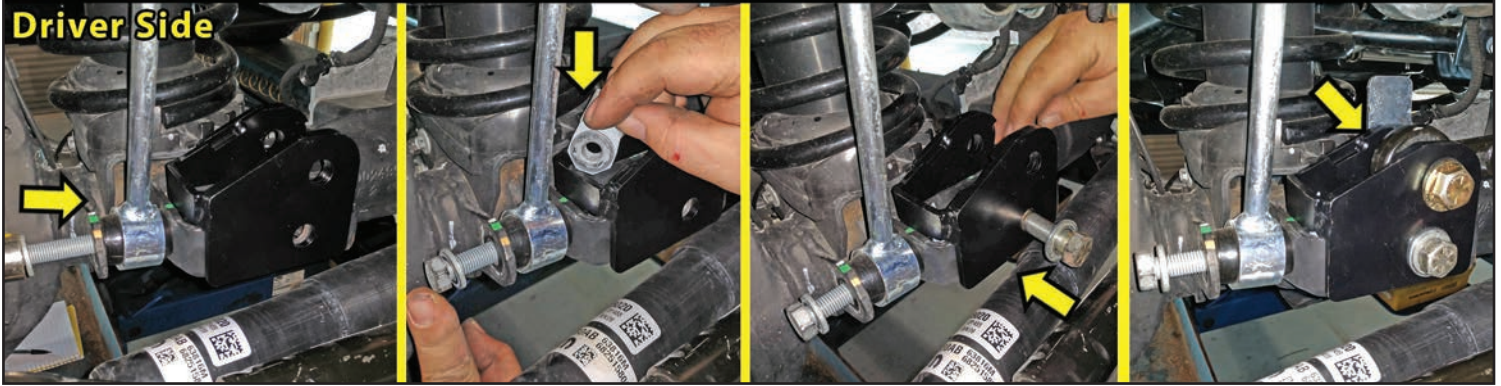

FRONT TIRES / WHEELS...

25. [Illustration 24] Install the front tires & wheels. [Lug Nuts 22mm] (140) Lower the vehicle to the ground.

⚠ WARNING: When the tires / wheels are installed, always check for and remove any corrosion, dirt, or foreign material on the wheel mounting surface, or anything that contacts the wheel mounting surface (hub, rotor, etc.). Installing wheels without the proper metal-to-metal contact at the wheel mounting surfaces can cause the lug nuts to loosen and the wheel to come off while the vehicle is in motion.

Reconnect the battery.

INITIAL FRONT CLEARANCE CHECK...

26. With the vehicle on the ground, cycle the steering lock-to-lock and check all components for proper operation and clearances. Pay special attention to the clearance between the tires / wheels and control arms, brake hoses, ABS wiring, etc.

Raise the vehicle back onto jack stands and secure as per **Step 1**. With the suspension 'hanging' at full extension travel, cycle the steering lock-to-lock and check all components for proper operation and clearances. Pay special attention to the clearance between the tires / wheels and control arms, brake hoses, ABS wiring, driveshaft-to-crossmember, etc.

Lower vehicle to the floor. Final tightening and adjustments to the front suspension installation will take place once rear lift is completed.

REAR INSTALLATION **⚠ NOTE:** Save ALL factory components and hardware for reuse, unless noted.

27. PREPARE VEHICLE FOR REAR...

Chock front tires and place transmission in neutral. Raise the rear of vehicle with a jack and secure a jack stand beneath each frame rail. Ease the frame down onto the stands, place transmission in Low Gear for Manual Transmission or Park for Automatic. Remove the rear wheels & tires. [Lug Nuts 22mm Deep Well Socket]

Support the rear axle with a hydraulic jack. Leave plenty of room to lower the rear axle.

REMOVE BRAKE LINE BRACKET...

28. [Illustration 25] On the Driver Side & Passenger Side, remove the brake line bracket from the upper control arm bracket at the axle. [13mm]

Illustration 24

Lug Nut Torque Sequence...

Follow the Sequence Below to Torque the Lug Nuts

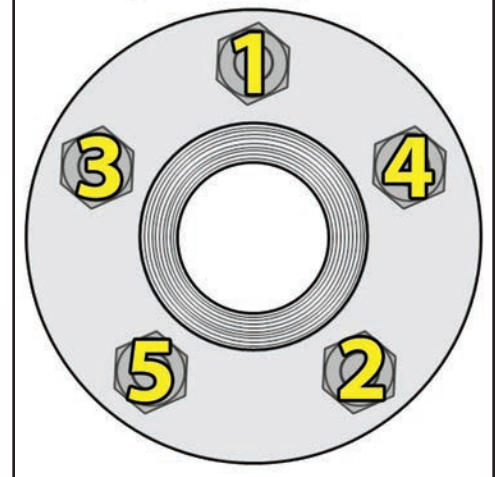

Illustration 25

Remove Brake Line Bracket...

Driver Side



RUBICONS: DISCONNECT REAR LOCKER...

29. □ [Illustration 26] **RUBICON Models:** The rear locker must be disconnected so the wiring connectors are not over-extended.

On the rear axle, unplug the locker wiring harness from the differential. Follow the wiring harness up and unclip the wiring harness clips from emergency brake cable.

Continue up the wiring harness and unclip the (2) wiring harness clips from the frame mount on the Driver Side located on the 'inner' frame rail above the axle. [Plastic Fastener Removal Tool]

Illustration 26**Disconnect Rear Locker...****DISCONNECT E-BRAKE FROM AXLE HOUSING & BRAKE ASSEMBLY...**

30. □□ [Illustration 27] Locate the emergency brake cable on the front of the rear axle. It runs from the center of the axle out to the brake housing. Pinch the ears of the aluminum fitting to release it from the axle mount. [Pliers] Disconnect the hook-end from the ring on the brake housing.

Illustration 27**Disconnect E-Brake Cable from Axle & Brake Assembly...****DISCONNECT REAR TRACK BAR AT THE FRAME...**

31. □ [Illustration 28] Disconnect the rear track bar from the passenger side frame bracket. [21mm] **TECH TIP** It may be necessary to raise or lower the axle to take the pressure off of the track bar bolt.

NOTE: This smaller existing hole in the OEM spring plate flange will be drilled to secure the SUPERLIFT Rear Track Bar Relocation Bracket (#55-31-5825).

Illustration 28**Disconnect Track Bar at Frame...****Passenger Side**

DISCONNECT REAR SWAY BAR LINK AT AXLE...

32. □□ [Illustration 29] Disconnect the sway bar link at the axle mount. [18mm socket / 18mm wrench]

DISCONNECT REAR SHOCKS AT AXLE MOUNT...

33. □□ [Illustration 30] **NOTE:** If you are installing the Shock Spacer Kit, disconnect the Lower Shock Mount ONLY.

Use a 18mm wrench and 18mm socket to remove the lower shock hardware. Retain hardware.

Illustration 29**Illustration 30****DISCONNECT REAR SWAY BAR LINK AT SWAY BAR...**

34. □□ [Illustration 31] Remove the factory hardware from the upper sway bar link at the sway bar. [6mm Allen and an 18mm wrench]

REMOVE REAR BUMPER INNER FENDER...

35 □□ [Illustration 32] **NOTE:** If you are installing the Shock Spacer Kit, Proceed to Step 37.

At the back of the rear fender, remove the (3) bolts retaining the rear bumper inner fender liner. [8mm socket] Retain hardware & inner liner.

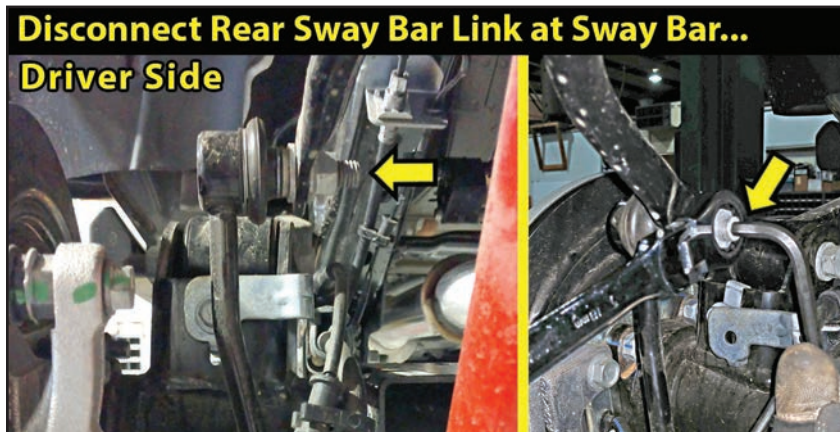
Illustration 31**Illustration 32****DISCONNECT REAR SHOCKS AT FRAME MOUNT...**

36. □□ [Illustration 33] **NOTE:** If you are installing the Shock Spacer Kit, disconnect the lower shock mount ONLY. The upper shock mount has the nut attached to the shock mount. Disconnect the upper shock mount. [18mm]. Remove the rear shocks. Retain factory hardware.

Illustration 33

REMOVE LOWER CONTROL ARMS...

37. □□ Disconnect factory lower control arms from the front and rear mounts. [21mm] Remove OEM lower control arms.

REMOVE REAR COIL SPRINGS...

38. □□ [Illustration 34] Lower the axle enough to facilitate removing the rear coil springs. Remove the coil springs. Retain the upper factory coil spring isolator.

⚠ NOTE: The factory upper spring isolator are Side Specific to properly align with the frame holes. MARK isolators: Driver & Passenger.

INSTALL REAR LOWER CONTROL ARMS...

39. □□ [Illustration 35] Locate the (2) SUPERLIFT rear lower control arms (#55-07-5800). They are not side specific.

Place the SUPERLIFT rear lower control arms into the factory mounts and install with the factory hardware. [21mm] **⚠ NOTE:** The bend of the lower control arms go toward the inside.

INSTALL REAR BUMP STOP SPACERS...

40. □□ [Illustration 36] Locate the (2) SUPERLIFT rear bump stop spacers (#55-07-5800). They are not side specific. Locate Hardware Bag #77-5802. Hardware PER Side: (2) 3/8" x 1-3/4" Bolt, Coarse Thread, (2) 3/8" SAE Washers & (2) 3/8" Flange Nut, Coarse Thread.

Place the SUPERLIFT rear bump stop spacer onto the bump stop mount pad at the axle next to the coil spring mount. Insert the 3/8" SAE washer onto the 3/8" x 1-1/4" bolt. Insert the bolt/washer down through the spacer and into the factory mount. Reach under the bump stop mount pad and above the axle tube to install 3/8" flange nut at the bottom. [9/16 wrench / 9/16 socket] Tighten & torque. [30]

INSTALL REAR COIL SPRINGS...

41. □□ [Illustration 37] Lower the axle enough to facilitate installing the new, taller rear coil springs. Locate the (2) SUPERLIFT rear coil springs.

Place the factory spring isolator of the side specific coil spring. **⚠ NOTE:** The factory upper spring isolator are Side Specific.

Insert the coil spring and isolator up and into the upper factory mount. Be sure that the coils are indexed so they seat properly then raise the axle enough to hold the coil springs in place.

Rotate the coils so that they seat properly in the coil buckets then raise the axle enough to seat the springs.

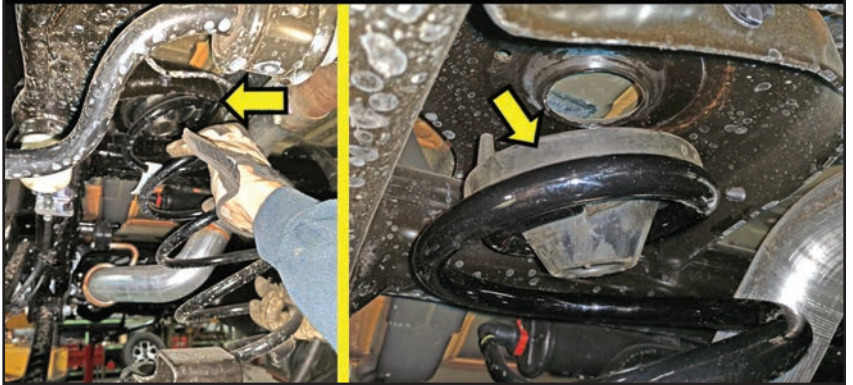
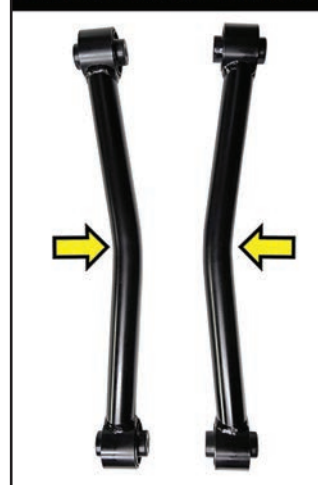
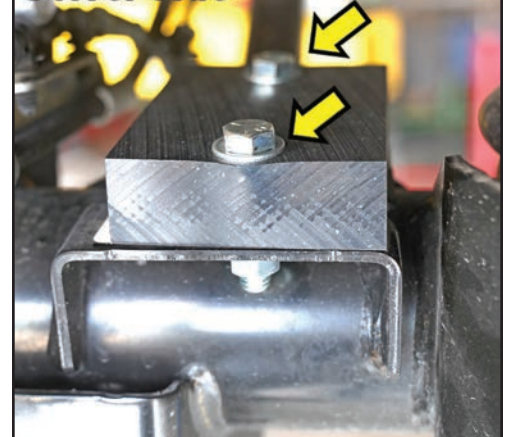
Illustration 34**Remove Rear Coil Springs...****Illustration 35****Install Rear LCA...****Illustration 36****Install Rear Bump Stop... Driver Side****Illustration 37****Install Rear Coil Spring with Isolator... Driver Side**

INSTALL REAR SHOCK SPACER INSTALL...

⚠ NOTE: IF you are installing the FOX rear shocks, Proceed to Step 43.

42. □□ [Illustration 38] Locate the (2) SUPERLIFT rear shock spacers (#55-14-5825). They are not side specific. Locate Hardware Bag #77-5800. Hardware PER Side: (1) #24-5704 Sleeve, 0.75" OD x 0.50" ID x 1.50" Long, (1) 1/2" x 1-1/2" Bolt, Coarse Thread, (1) 1/2" SAE Washer, (1) 1/2" Flange Nut, Coarse Thread (1) 1/2" x 3-1/2" Bolt, Coarse Thread, (1) 1/2" SAE Washer & (1) 1/2" Nyloc Nut, Coarse Thread.

Place the SUPERLIFT rear shock spacer on the factory shock mount pointing rearward and up. Insert the 1/2" SAE washer onto the 1/2" x 1-1/2" bolt. Insert the bolt/washer up through the bottom hole of the bracket/factory mount. Install 3/8" flange nut. [3/4 wrench / 3/4 socket]

Attach 1/2" SAE Washer onto the 1/2" x 3-1/2" bolt. Insert the bolt pointing inward into the shock spacer/factory shock mount. Attach #24-5704 sleeve. Continue bolt through spacer/shock mount, then attach 1/2" SAE washer & 1/2" Nyloc nut. Snug tighten only. [3/4" wrench / 3/4" socket]

Swing factory shock into place and align with the upper hole of the spacer. Install shock with factory hardware with the bolt pointing inward. Snug tighten only. [18mm wrench \ 18mm socket]

Shocks will be tightened completely when the vehicle is set on the ground.

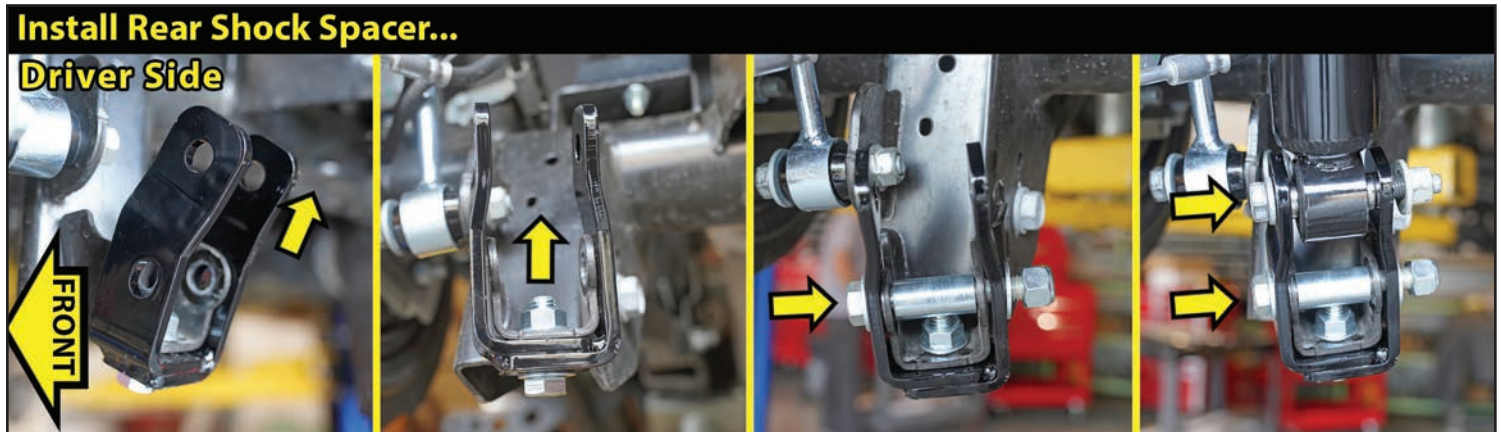
Illustration 38**INSTALL FOX SHOCK & INNER FENDER LINER...**

43. □□ [Illustration 39] Locate the #985-24-178 FOX Shocks. Install the FOX shocks using the factory hardware at the upper frame mount. [18mm socket]

Install the FOX shock at the lower mount at the axle using the factory hardware with the bolt pointing inward. Snug tighten only. [18mm wrench \ 18mm socket]

Reattach the rear bumper inner fender liner using the (3) factory retaining bolts. [8mm socket]

Illustration 39

INSTALL REAR SWAY BAR LINKS...

⚠️ WARNING: Due to your selection of tire & wheel combination, SUPERLIFT has two (2) options for installing the supplied sway bar links. IF you are running factory wheels or aftermarket 17" or 18" wheels with the same width and offset/backspacing, install the sway bar links in the factory position **OUTSIDE** the sway bar. Aftermarket 20" or larger diameter wheels and RUBICON models should allow you to run in the factory **OUTSIDE** position also.

IF you have selected an aftermarket 17" or 18" wheel that is wider and/or has a more Positive offset where the wheel is closer to the sway bar, install the links as shown in the **INSIDE** position.

⚠️ NOTE: Always check the wheel/tire clearance to the sway bar links and install per your application.

44. Locate the (2) SUPERLIFT rear sway bar links (#44-17-5050). **⚠️ NOTE:** These supplied front sway bar links are longer than the supplied front sway bar links.

Locate Hardware Bag #77-5801 & #77-5801A. Hardware PER Side: (2) 01-60418 - Bushing, Hourglass, (2) #24-5704 - Sleeve, 0.75" OD x 0.50" ID x 1.50" Long, (1) 12mm x 70mm Bolt, Coarse Thread, (2) 12mm Washer & (1) 12mm Nut, Nyloc Coarse Thread.

☐☐ [Illustration 40] Lightly grease and install/press the hourglass shaped bushing and 0.50" ID sleeve into each end of the sway bar link end.

To install in the factory OUTSIDE Position:

☐☐ [Illustration 41] Use the factory hardware to attach the lower sway bar link mount at the axle mount. Install bolt pointing inward. [Bolt: 18mm, Nut: 18mm]

Attach 12mm Washer onto the 12mm x 70mm bolt. Insert the bolt pointing inward into the new sway bar link. Continue bolt through sway bar, then attach 12mm washer & 12mm Nyloc nut. Snug tighten only. [19mm wrench / 19mm socket]

To install in the INSIDE Position:

☐☐ [Illustration 42] Use the factory hardware to attach the lower sway bar link mount at the axle mount on the inside of the mount. Install bolt pointing outward. [Bolt: 18mm, Nut: 18mm]

Attach 12mm Washer onto the 12mm x 70mm bolt. Insert the bolt pointing outward into the sway bar. Continue bolt through sway bar link, then attach 12mm washer & 12mm Nyloc nut. Snug tighten only. [19mm wrench / 19mm socket]

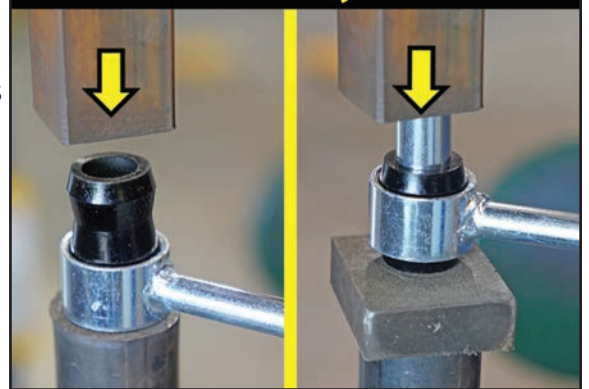
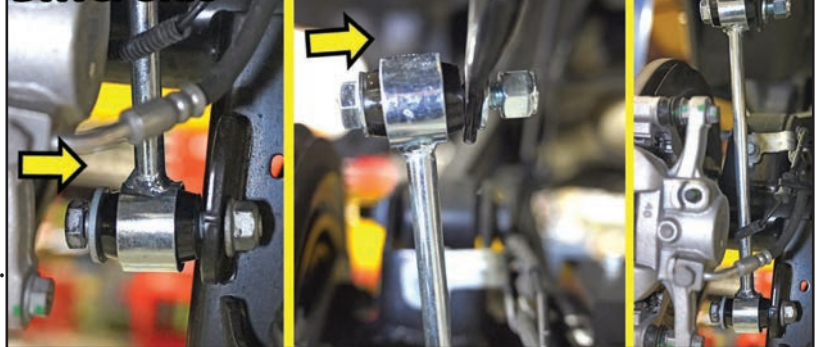
Illustration 40**Assemble Rear Sway Bar Links...****Illustration 41****Install Links to the OUTSIDE of the Sway Bar...****Driver Side****Illustration 42****Install Links to the INSIDE of the Sway Bar...****Driver Side**

REATTACH BRAKE LINE BRACKET...

45. □□ [Illustration 43] Reattach the brake line bracket to the upper control arm bracket at the axle. [13mm] **NOTE:** IF you installed the sway bar links in the INSIDE position, make sure the brake lines have adequate clearance and do not chaff against the sway bar link. You should bend the factory brake line bracket slightly to gain clearance.

RUBICONS: RECONNECT REAR LOCKER...

46. □ [Illustration 44] **RUBICON Models:** On the rear axle, plug the locker wiring harness back into the differential. Follow the wiring harness up and reclip the wiring harness clips to emergency brake cable. Continue up the wiring harness and reclip the (2) wiring harness clips back to the frame mount on the Driver Side located on the 'inner' frame rail above the axle.

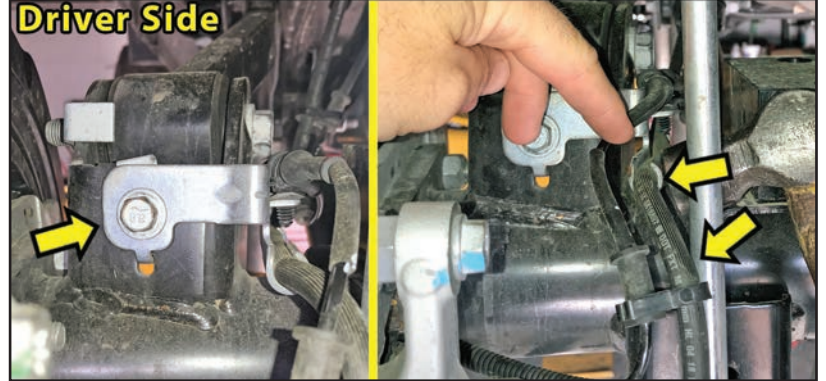
Illustration 43**Reattach Brake Line Bracket...
Driver Side****Illustration 44****Reconnect Rear Locker...****RECONNECT E-BRAKE TO AXLE HOUSING & BRAKE ASSEMBLY...**

47. □□ [Illustration 45] Locate the emergency brake cable on the front of the rear axle. Pinch the ears of the aluminum fitting to clip it back into place the axle mount. [Pliers] Reconnect the hook-end to the ring on the brake housing.

Illustration 45**Reconnect E-Brake Cable to Axle & Brake Assembly...**

INSTALL REAR TRACK BAR RELOCATION BRACKET...

48. Locate the SUPERLIFT Rear Track Bar Relocation Bracket (#55-31-5825). Locate Hardware Bag #77-5824. Hardware PER Side: (1) 7/16" x 5", Course Thread, Grade 8, (1) 7/16" Nyloc Nut, Course Thread, (2) 7/16" USS Flat Washer, (1) 9/16" x 3", Course Thread, Grade 8, (1) 9/16" Nyloc Nut, Course Thread, (2) 9/16" SAE Flat Washer, (1) 1/2" x 1-1/4", Course Thread, Grade 8, (1) 1/2" Nyloc Nut, Course Thread and (1) 1/2" SAE Flat Washer.

[Illustration 46-A] Position the 55-31-5825 track bar bracket into the OEM track bar frame bracket.

[Illustration 46-B] Loosely secure with 9/16" bolt. Insert the 9/16" SAE washer onto the 9/16" x 3" bolt. Insert the bolt/washer through the 31-5825 bracket/factory mount from rear-to-front. Attach the 9/16" SAE washer and Nyloc nut. Snug tighten only.

[Illustration 46-C] Insert the 7/16" USS washer onto the 7/16" x 5" bolt. From the outside of the frame rail, insert the bolt/washer through the 31-5825 bracket into the existing OEM hole in the frame rail then out through the bracket. Attach the 7/16" USS washer & Nyloc nut. Tighten the 7/16" bolt. [5/8"] (45)

[Illustration 46-D] Using the 31-5825 bracket as a guide, drill a 1/2" hole through the OEM spring plate flange. **⚠ NOTE:** Be careful not to damage the spring or spring isolator when drilling.

[Illustration 46-E] Install the 1/2" x 1-1/4" bolt through the drilled hole from front-to-rear. Attach the 1/2" SAE washer & Nyloc nut.

Tighten the 9/16" bolt at the OEM track bar frame bracket. [nut: 7/8" | bolt: 13/16"] (95)

[Illustration 46-F] Tighten the 1/2" bolt at the spring flange plate. [3/4"] (65)

⚠ NOTE: Installation is shown with Optional SUPERLIFT Adjustable Replacement Rear Track Bar.

[Illustration 46-G] Install the track bar into the bracket and attach using the OEM hardware. Insert the bolt from front-to-rear. Snug tighten only. [21mm] **⚠ NOTE:** Tighten & torque the track bar bolt after the weight of the vehicle is on the suspension.

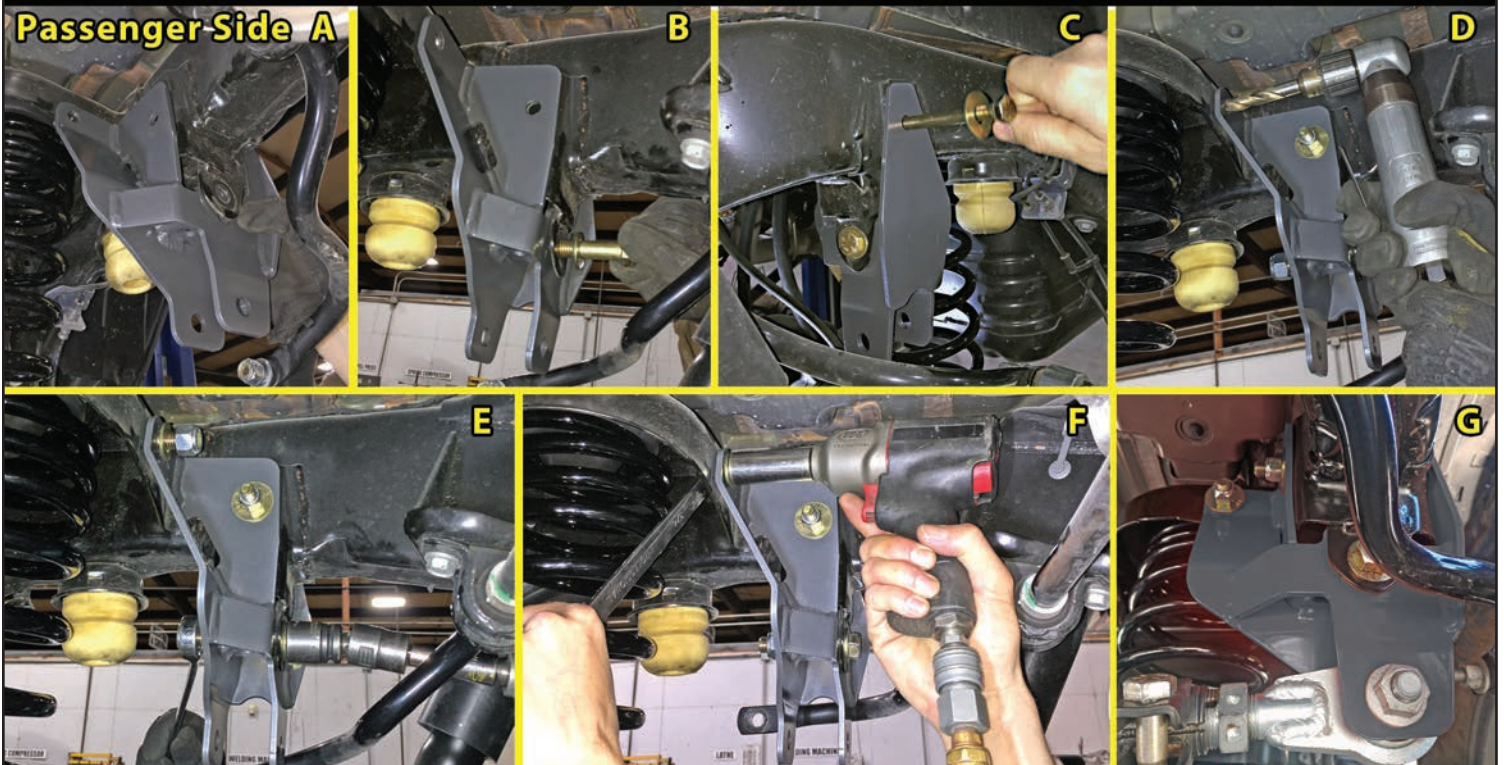
Illustration 46**Install Rear Track Bar Relocation Bracket...**

REAR TIRES / WHEELS...

49. [Illustration 47] Install the rear tires & wheels. [Lug Nuts 22mm] (140)

⚠ WARNING: When the tires / wheels are installed, always check for and remove any corrosion, dirt, or foreign material on the wheel mounting surface, or anything that contacts the wheel mounting surface (hub, rotor, etc.). Installing wheels without the proper metal-to-metal contact at the wheel mounting surfaces can cause the lug nuts to loosen and the wheel to come off while the vehicle is in motion.

⚠ WARNING: Retighten lug nuts at 500 miles after any wheel change, or anytime the lug nuts are loosened. Failure to do so could cause wheels to come off while vehicle is in motion.

FINAL CHECKS

With the vehicle still on jack stands, and the suspension "hanging" at full extension travel, check all components for proper operation and clearances. Pay special attention to clearance between the tires / wheels and brake hoses, ABS wires, locker wiring harness, driveshaft, etc.

Lower the vehicle to the ground.

HARDWARE TIGHTENING SEQUENCE...

50. Front track bar bracket & track bar at axle end (125).
 Front shock spacer bracket at factory shock (55).
 Front shock spacer bracket at shock mount (55).
 Front shock spacer bracket at bottom (65).
 Front FOX shock absorber eyes (55).
 Front sway bar links, at frame and at sway bar (75).
 Rear track bar at axle end (125). Rear Track Bar at frame relocation bracket. (170).
 Rear shock spacer bracket at factory shock (55).
 Rear shock spacer bracket at shock mount (55).
 Rear shock spacer bracket at bottom (65).
 Rear FOX shock absorber eyes (55).
 Rear sway bar links, at frame and at sway bar (75).

CLEARANCE CHECK...

51. Check all hardware for proper torque specifications.

With the vehicle on the ground, check all components for proper operation and clearances. Pay special attention to the clearance between the tires / wheels, brake hoses, wiring, etc. Check tire/wheel clearance with the fenders/bumper as well as with the steering knuckle.

WHEEL ALIGNMENT...

52. Realign vehicle to factory OEM specifications. It is necessary to have a proper and professional wheel alignment performed by a certified alignment technician. Align the vehicle to factory specifications. It is recommended that your vehicle alignment be checked after any off-road driving.

HEADLIGHTS...

53. Re-adjust headlights to proper setting. In addition to your vehicle alignment, for your safety and others, it is necessary to check and adjust your vehicle head lamps for proper aim and alignment.

Illustration 47**Lug Nut Torque Sequence...**

Follow the Sequence Below to Torque the Lug Nuts

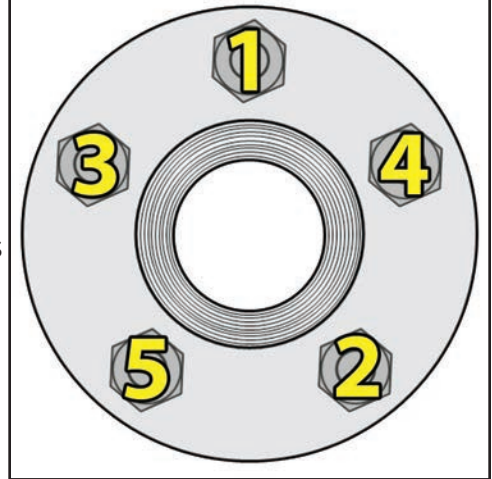

FOUR WHEEL DRIVE...

54. Activate the four wheel drive system and check for proper engagement.

SUPERLIFT WARNING DECAL...

55. **⚠️WARNING:** Install the WARNING TO DRIVER decal on the inside of the windshield, or on the dash, within Driver's view.

IMPORTANT MAINTENANCE INFORMATION

⚠️WARNING: It is the ultimate buyer's responsibility to have all bolts / nuts checked for tightness after the first 100 miles and then every 1000 miles. The steering, suspension and driveline systems, plus wheel alignment should be inspected by a qualified professional mechanic at least every 3000 miles.

LIMITED LIFETIME WARRANTY / WARNINGS

Your SUPERLIFT® product is covered by the Limited Warranty explained below that gives you specific legal rights. This limited warranty is the only warranty SUPERLIFT® makes in connection with your product purchase. SUPERLIFT® neither assumes nor authorizes any retailer or other person or entity to assume for it any other obligation or liability in connection with this product or limited warranty.

SUPERLIFT, LLC, LIMITED LIFETIME WARRANTY

What is covered? Subject to the terms below, SUPERLIFT® will repair or replace its products found defective in materials or workmanship for so long as the original purchaser owns the vehicle on which the product was originally installed. Your warranter is SUPERLIFT, LLC, doing business as SUPERLIFT® Suspension Systems ("SUPERLIFT®").

What is not covered? Your SUPERLIFT® Limited Warranty does not cover products SUPERLIFT® determines to have been damaged by or subjected to:

- Alteration, modification or failure to maintain.
- Normal wear and tear (bushings, rod ends, etc.). Scratches or defects in product finishes (powder coating, plating, etc.).
- Damage to, or resulting from, the vehicle's electronic stability system, related components or other vehicle systems.
- Racing or other vehicle competitions or contests. Accidents, impact by rocks, trees, obstacles or other aspects of the environment.
- Theft, vandalism or other intentional damage.

Remedy Limited to Repair or Replacement. The exclusive remedy provided hereunder shall, upon SUPERLIFT's inspection and at SUPERLIFT's option, be either repair or replacement of the product covered under this Limited Warranty. Customers requesting warranty consideration should contact SUPERLIFT® by phone (1-800-551-4955) to obtain a Returned Goods Authorization number. All removal, shipping and installation costs are customer's responsibility.

If a replacement part is needed before the SUPERLIFT® part in question can be returned, you must first purchase the replacement part. Then, if the part in question is deemed warrant-able, you will be credited / refunded.

OTHER LIMITATIONS - EXCLUSION OF DAMAGES - YOUR RIGHTS UNDER STATE LAW

- Neither SUPERLIFT® nor your independent SUPERLIFT® dealer are responsible for any time loss, rental costs, or for any incidental, consequential or other damages you may have.
- This Limited Warranty gives you specific rights, and this is the only warranty SUPERLIFT® makes in connection with your product purchase. You may also have other rights that vary from state to state. For example, while all implied warranties are disclaimed herein, any implied warranty required by law is limited to the terms of our Limited Lifetime Warranty as described above. Some states do not allow limitations of how long an implied warranty lasts and / or do not allow the exclusion or limitation of incidental or consequential damages, so the limitations and exclusions herein may not apply to you.

SUPERLIFT® neither assumes nor authorizes any retailer or other person or entity to assume for it any other obligation or liability in connection with this product or Limited Warranty.

IMPORTANT PRODUCT USE AND SAFETY INFORMATION / WARNINGS

⚠ WARNING: As a general rule, the taller a vehicle is, the easier it will roll over. Offset, as much as possible, what is lost in rollover resistance by increasing tire track width. In other words, go “wide” as you go “tall”; always use as wide a tire and wheel combination as feasible to enhance vehicle stability. We strongly recommend, because of rollover possibility, that the vehicle be equipped with a functional roll bar and cage system. Seat belts and shoulder harnesses should be worn at all times. Avoid situations where a side rollover may occur.

Generally, braking performance and capabilities are decreased when significantly larger / heavier tires and wheels are used. Take this into consideration while driving. Also, changing axle gear ratios or using tires that are taller or shorter than factory height will cause an erroneous speedometer reading. On vehicles equipped with an electronic speedometer, the speed signal impacts other important functions as well. Speedometer recalibration for both mechanical and electronic types is highly recommended.

Do not add, alter, or fabricate any factory or aftermarket parts to increase vehicle height over the intended height of the SUPERLIFT® product purchased. Mixing component brands is not recommended.

WE WANT TO SEE YOUR RIDE...

Grab photos of your SUPERLIFT Equipped truck in various poses and in action.

Email pictures to us at sales@superlift.com

Tag us on **Facebook:** [@superlift suspension systems](https://www.facebook.com/superliftsuspension)

Tag us on **Instagram:** [#superlift](https://www.instagram.com/superlift), [#superliftsuspension](https://www.instagram.com/superliftsuspension), [#superliftequipped](https://www.instagram.com/superliftequipped)

THANKS For Choosing SUPERLIFT...

For questions, technical support and warranty issues relating to this SUPERLIFT products, please contact SUPERLIFT directly.

SUPERLIFT SUSPENSION
300 Huey Lenard Loop Rd.
West Monroe, Louisiana 71292
Phone: (318) 397-3000
Sales / Tech: (800) 551-4955
Fax: (318) 397-3040
SUPERLIFT.COM