

INSTALLATION INSTRUCTIONS

⚠ WARNING

To properly install this headlight you should have a good understanding of automotive electrical procedures and systems, and proficiency in the installation of headlights. **IF YOU DO NOT, PLEASE SEEK PROFESSIONAL ASSISTANCE.**

BEFORE INSTALLATION:

- Estimated Time:** 30 minutes
- Tools Needed:** T15 Torx Wrench
Flathead Screwdriver
- Wire Functions:** Black = Ground
Yellow = Low Beam
White = High Beam
Orange = Front Turn
Red = Front Position
Blue = Daytime Running Light (DRL)
- In the Box:** (x2) EVO J3 Headlights
(x2) H13 Harnesses for DOT versions
OR (x2) H4 Harnesses for ECE versions
- Input Voltage:** 12V DC
- Operating Voltage:** 9-16V DC

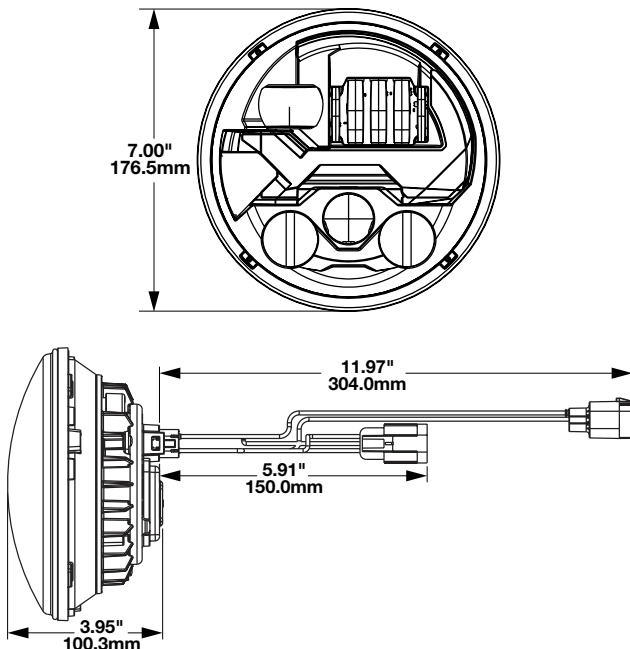

PRE-INSTALLATION INSTRUCTIONS:

1. Read all safety notes and mounting guidelines before installing the product. Verify that all parts listed under "In the Box" are present and complete.
2. Inspect the product for damage. DO NOT install the product if there is any damage. Contact the authorized retailer where you purchased it to initiate a warranty claim if there is damage.
3. Verify that all power supply and/or charging systems comply to the specified voltage limits for the light.

REGULATORY COMPLIANCE:



NOTES:

To properly install this light you should have a good understanding of automotive electrical procedures and systems, and proficiency in the installation of headlights. **IF YOU DO NOT, PLEASE SEEK PROFESSIONAL ASSISTANCE.**

Each kit comes with a LH (Left Hand) and RH (Right Hand) lamp. This refers to the side of the vehicle when sitting in the Driver's seat. The bend in the Turn Signal Optic points outward.



PRODUCT WARRANTY:

If you have issues with a J.W. Speaker product, please contact the authorized retailer where you purchased it.



INSTALLATION INSTRUCTIONS:

1. Loosen the Phillips head screws in the fasteners that secure the top of the grill. **NOTE:** Some model years have fasteners that have a center post to pry out instead of screws.



2. Carefully remove the 6 fasteners by prying them up at the base using a flat blade screw driver. Save the 6 fasteners.



3. Carefully remove the front grill by pulling the **TOP** portion forward until it unsnaps. Start near one headlight and work across to the other light.



4. Carefully unsnap the clips at the bottom of the grill and let it rest across the bumper. **NOTE:** These clips may break if not treated with care.

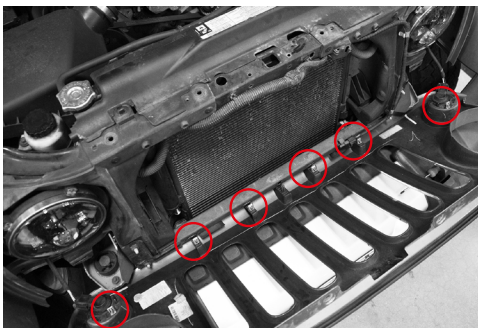

5. Use a T15 Torx driver to remove the 4 screws holding the headlight retaining ring. **Save the 4 screws.**



6. Remove the retaining ring and headlight from the mounting ring. Box" are present and complete.

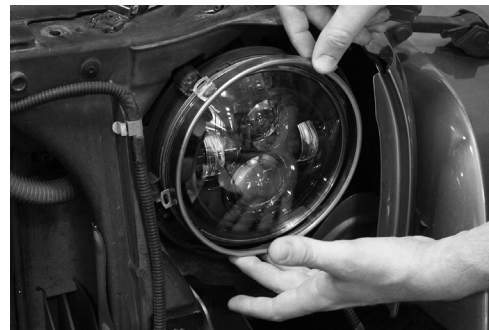

7. Unplug the existing headlight and turn signal. **NOTE:** On newer models there is (1) a red button on the plug that must be pushed up, and (2) a button that must be pressed and held to unplug the existing lamp.



8. Plug in the new LED headlight remembering to plug in the turn signal as well. Then install it into the mounting ring. **NOTE:** On ECE versions, connect the **BLUE** wire for DRL.



INSTALLATION INSTRUCTIONS:

9. Align the alignment lugs on the lamp with the slots in the ring. The lamp will only fit in one orientation, and from the front the "Turn Signal curve" should follow the curve of the hood.



10. Re-attach the retaining ring. Align all 4 tabs on the ring with the screw holes. It will only fit in one orientation. Install 4 screws from step 5 using the T15 Torx driver.

11. Repeat steps 5 - 10 on the second lamp.

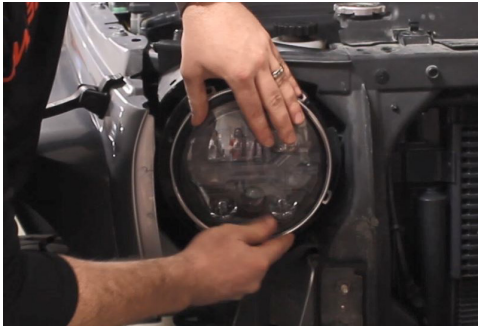

12. Attach the ground to the battery to test lamp function.

13. Before attaching the grill back on your Jeep be sure to aim your EVO J3 lamps using the J-Link or using the instructions on the next page.

NOTE: BEFORE YOU PUT THE GRILL BACK ON, this is the best time to upgrade stock turn signals with J.W. Speaker's Trail 6 Pro or Trail 6 Sport off-road lights. See the "Jeep Trail 6 Pro and Sport Instructions."



14. Re-attach the front grill by carefully pressing on the grill until the clips lock back into place.

15. Re-install the 6 fasteners from step 2. The screw in the fastener must be fully extended as the fasteners are pressed into place. Tighten the 6 Phillips head screws into the fasteners.

Note: Do not over tighten the screws.

J.W. SPEAKER®
Engineered. Lighting. Solutions.

HEADLIGHT AIMING INSTRUCTIONS

FOR LOW AND HIGH/LOW HEADLIGHTS

⚠ WARNING

Headlight must be securely mounted and properly aimed such that the beam pattern "cut off line" complies with all applicable regulations. **If you are not familiar with the legal requirements for aiming your headlights, please see a professional service provider.** We recommend that headlights are aimed with a headlight aiming system for proper alignment. Failure to properly aim your headlights is a risk to other drivers and could result in tickets or citations with local authorities. J.W. Speaker is not liable for any damage to the vehicle or light, or any tickets/citations as a result of using these guidelines.

BEFORE AIMING:

1. Vehicle is being aimed on a level surface.
2. All tires are properly inflated.
3. Vehicle is at normal driving height.

REQUIRED SUPPLIES:

- Tape or chalk to mark lines
- Corresponding tools for your vehicle's aiming mechanism

OPTIONAL SUPPLIES:

- Laser level to expedite the aiming process and will help to increase accuracy in aiming

KEY TERMS:

Kink (elbow): The top of the pattern that is the cut-off when aimed at a wall.

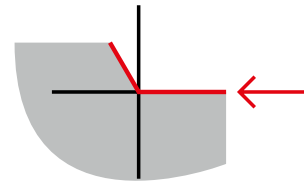

Alignment Point: The center of the angle in the Kink that must align to the center point when aiming the light at a wall.

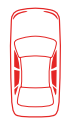
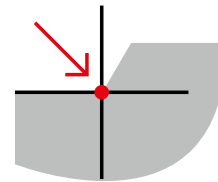

LHT (Left Hand Traffic):
ECE Regulation countries
like the United Kingdom

RHT (Right Hand Traffic):
DOT (and some ECE)
Regulation countries like
the United Kingdom



*The following instructions are illustrated for RHT vehicles.
Aiming for LHT vehicles will be mirrored to what is shown.*

AIMING GUIDELINES:

1. Park your vehicle close to a wall, in an area where there is at least 7.62 meters (25 feet) of space behind it (excluding the car length).

2. On the wall, draw a line from the ground to the approximate center point of the headlight. Repeat for the other headlight. This will create your Y axis lines.

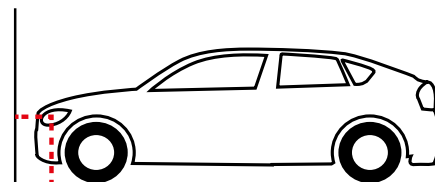

J.W. SPEAKER
Engineered. Lighting. Solutions.

AIMING GUIDELINES CONTINUED:

3. Connect the center points between headlights in a straight line, using chalk or tape. This will create your X axis (horizontal) line. **NOTE:** Use a straight edge and a level to make sure this line is straight.



4. Extend your vertical, Y (vertical) axis lines up approximately 3 feet. Your lines should match the diagram below, when looking at the lines straight on.



5. Reverse your vehicle in a straight line so that the front of the headlights are 7.62 meters (25 feet) back from the wall.

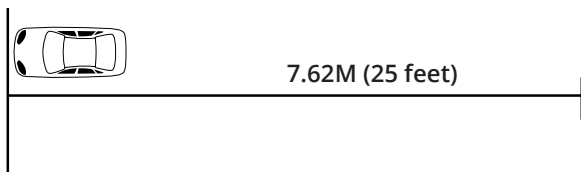

The goal of this sheet is to aim BOTH of your headlights so that the **Alignment Point** is at the crosssection of the horizontal X and vertical Y lines you have drawn. The following directions illustrate the process and proper aiming of headlights.

6. When you first turn on your vehicle after installing your headlights, the **Alignment Points** may be positioned differently than shown and will likely be aimed differently from each other.

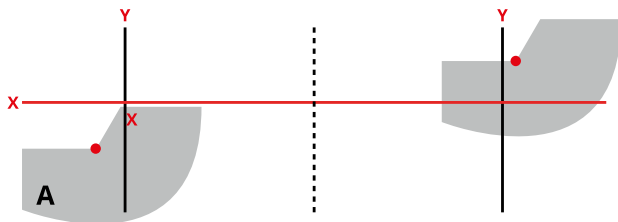

7. Using the alignment mechanisms in your vehicle, adjust one headlight vertically until the **Alignment Point** is even with the X axis.

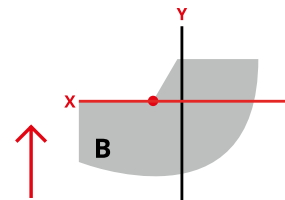

8. On the same headlight, adjust horizontally until the **Alignment Point** is even with the Y axis.

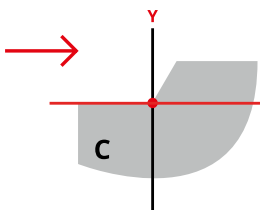

9. Repeat this process on the other headlight. Both headlights should match the diagram below, where the **Alignment Point** is even with the point where the X and Y axis crosses.

