

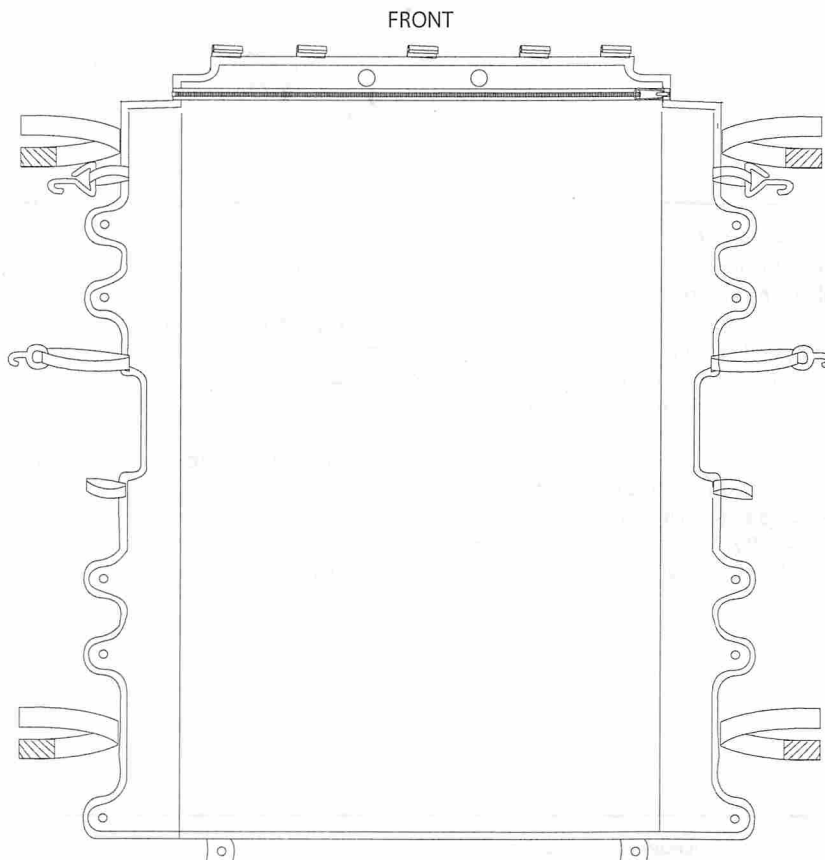

Jeep Wrangler Sunbonnet Top - 2 Door Mesh/Vinyl

A

Reference www.jeep.com/wranglertop



2" x 14" (VINYL ONLY)

CONTENTS: MESH/VINYL SUNBONNET TOP 1 **A**
 STAINLESS STEEL SNAP STUD 12 **B**
 STAINLESS STEEL SNAP COVER 12 **C**
 2 14" STRIPS OF FELT **D**

CONTENIDO: CAPO DEL SOL MALLA/VINILO 1 **A**
 PERNO DE ACERO INOXIDABLE 12 **B**
 CUBIERTA DE ACERO INOXIDABLE 12 **C**
 2 14" TIRAS DE FIELTRO **D**

CONTENU: BONNET DE SOLEIL MAILLE / VINYLE 1 **A**
 GOUJON D'ACIER INOXYDABLE 12 **B**
 COUVERCLE EN ACIER INOXYDABLE 12 **C**
 2 14" BANDES DE FEUTRE **D**



TOOLS REQUIRED: PHILLIPS HEAD SCREWDRIVER
 #20 TORX HEAD SCREWDRIVER
 T40 & T50 TORX BIT (VEHICLE TOOL KIT)
 HERRAMIENTAS REQUERIDAS: DESTORNILLADOR PHILLIPS
 DESTORNILLADOR TORX #20
 T40 y T50 TORX BIT (KIT DE HERRAMIENTAS PARA VEHICULOS)
 OUTILS REQUIS: TOURNEVIS PHILLIPS
 TOURNEVIS TORX #20
 BIT TORX T40 ET T50 (KIT OUTIL DE VÉHICULE)

GB	INSTALLATION INSTRUCTIONS	SUNBONNET TOP
E	INSTRUCCIONES DE MONTAJE	CAPO DEL SOL
F	NOTICE DE MONTAGE	BONNET DE SOLEIL

Remove Screws to Release Windshield (x4). Refer to Owner's Manual.
 Retire los tornillos para liberar el parabrisas (x4). Consulte el Manual del propietario.
 Retirez les vis pour libérer le pare-brise (x4). Reportez-vous au manuel du propriétaire.

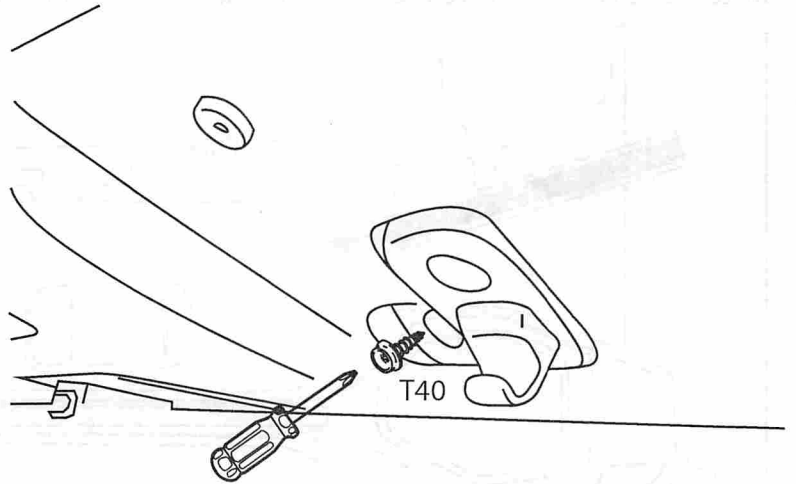
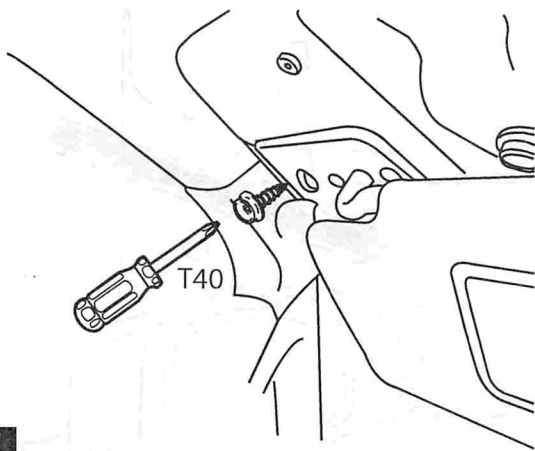

1

Release Windshield halfway. Do not damage wipers.
 Libera el parabrisas a mitad de camino. No dañe los limpiaparabrisas.
 Relâchez le pare-brise à mi-chemin. Ne pas endommager les essuie-glaces.

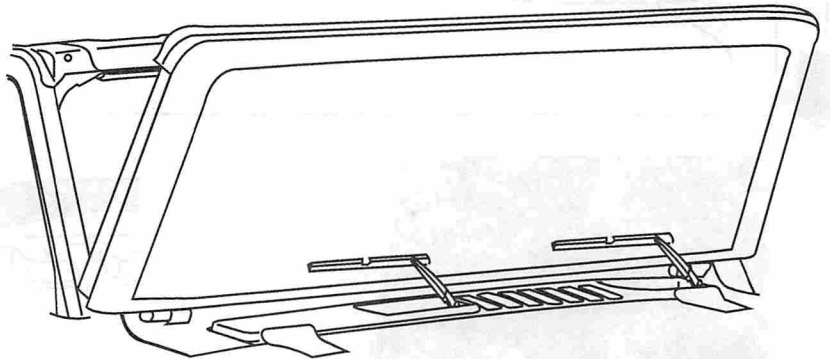

2

Install clips and align holes (x5).
 Instale los broches y alinee los agujeros (x5).
 Installez les agrafes et alignez les trous (x5).

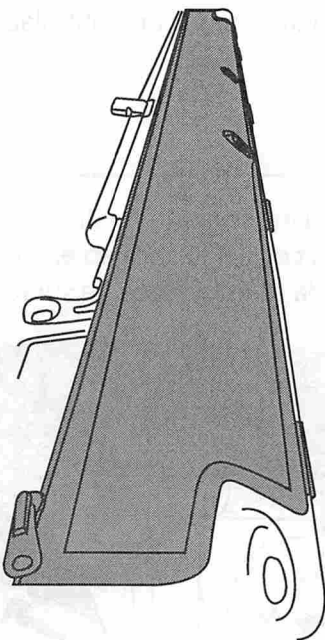

3

Install screws to reattach Windshield (x4).
 Instale los tornillos para volver a colocar el parabrisas (x4).
 Installez les vis pour rattacher le pare-brise (x4).

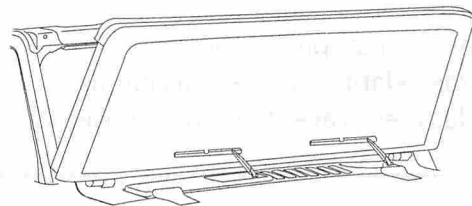

Do not tighten until last step!
No apriete hasta el último paso!
Ne pas serrer jusqu'à la dernière étape!

Bolt Torque 19 N-m (14 Ft-lbs)

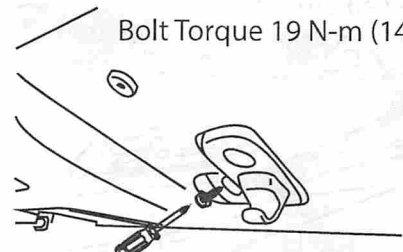
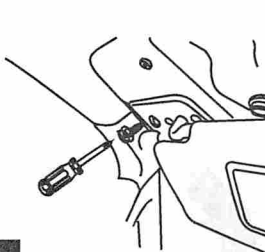

4

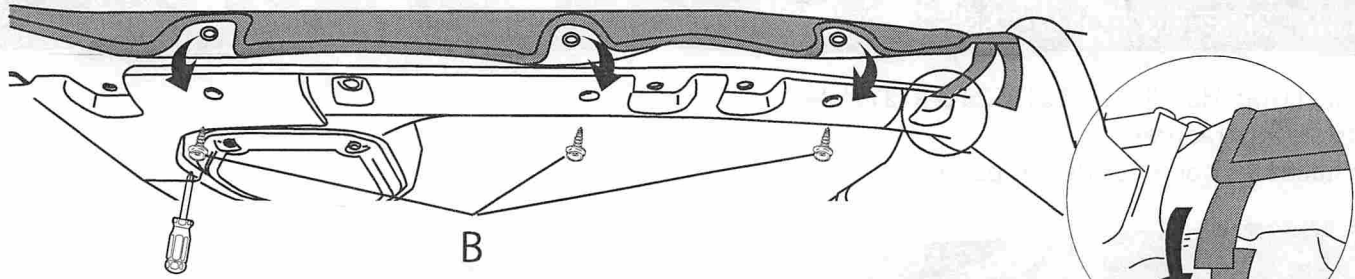

Remove Screws/Install studs. Locations identified by bonnet. (6 per side)
 Retire los tornillos / instale los pernos. Ubicaciones identificadas por bonete. (6 por lado)
 Enlever les vis / Installer les goujons. Emplacements identifiés par le capot. (6 par côté)

Install Velcro. (1 per side)
 Instale velcro. (1 por lado)
 Installez le velcro. (1 par côté)

9

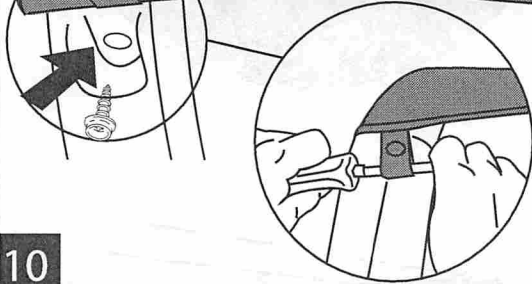
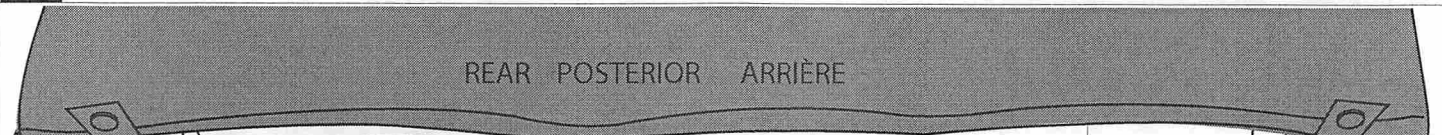

Remove Screws/Install Studs. (x2)
 Retire los tornillos/Instale pernos. (x2)
 Enlever les vis/Installez des goujons. (x2)

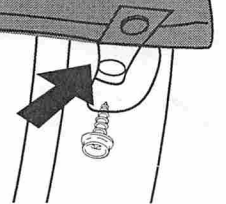

Complete Step 4.
 Completa el paso 4.
 Terminez l'étape 4.

10

11

REMOVAL INSTRUCTIONS

INSTRUCCIONES DE EXTRACCIÓN

INSTRUCTIONS DE RETRAIT

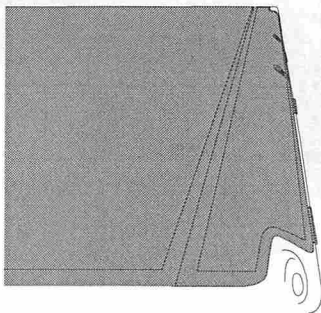

Unzip and remove rear piece. Leave front piece on vehicle.
 Descomprimir y quitar la pieza trasera. Deje la pieza delantera en el vehículo.
 Décompressez et retirez la pièce arrière. Laissez la pièce avant sur le véhicule.

1

Install black snap caps 12 (Qty. 12)
 Instale tapas de seguridad negras 12 (Cant. 12)
 Installez des capuchons noirs 12 (Qté. 12)

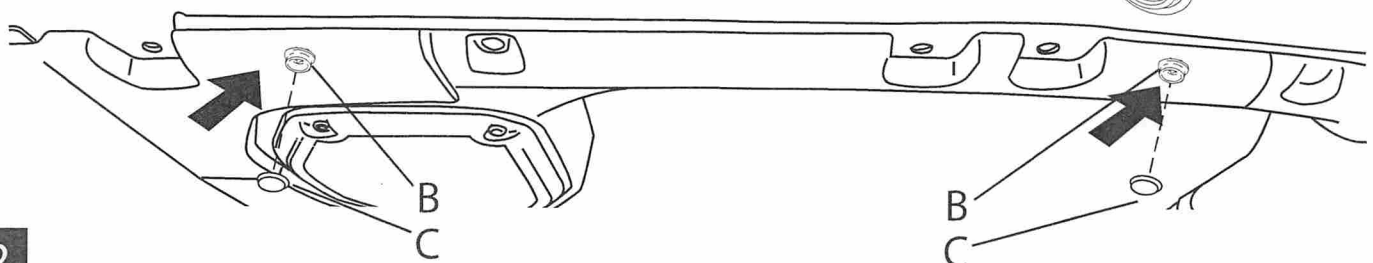

2