



**1-800-779-2102**

Mon – Thurs: 8:00am - 5:00pm | Friday: 8:00am - 4:00pm CST

**INSPECT YOUR PRODUCT FOR DAMAGE & MISSING  
PARTS BEFORE PROCEEDING TO INSTALLATION**

**PROCEDURE FOR RETURNS OR MISSING HARDWARE**

-PLEASE CONTACT THE ORIGINAL POINT OF PURCHASE FOR:  
SHIPPING DAMAGE, RETURNS, OR WARRANTY CLAIMS

-CONTACT DEE ZEE DIRECTLY FOR MISSING PARTS OR HARDWARE

**WWW.DEEZEE.COM**

REGISTER YOUR PRODUCT ONLINE: [www.deezee.com/registration](http://www.deezee.com/registration)

VIEW INSTRUCTIONS ONLINE: [www.deezee.com/instructions](http://www.deezee.com/instructions)

---

**⚠ WARNING:** Cancer and Reproductive Harm  
[www.P65Warnings.ca.gov](http://www.P65Warnings.ca.gov)

Operating, servicing, and maintaining a passenger vehicle can expose you to chemicals such as lead, phthalates, engine exhaust, and carbon monoxide that are known to the State of California cause cancer and birth defects or other reproductive harm. To minimize exposure, service your vehicle and its accessories in a well-vented area and wear gloves or wash your hands frequently.



## **DEE ZEE, INC. WARRANTY AGREEMENT**

Dee Zee, Inc. guarantees the original purchaser a limited lifetime warranty against manufacturer defects in materials, workmanship, and design under normal use, excluding damage resulting from road hazards such as gravel or other debris, product misuse, improper installation, impairments from accidents, product modifications, improper repairs, spills, vandalism, product neglect, or acts of God.

This warranty applies only to the original purchaser of new product(s) and is limited to the replacement of genuine Dee Zee products. Modification of any kind to Dee Zee products voids all warranty coverage. Warranty does not include electrical components, installation, cost of removal, labor, transportation costs, loss of use, inconvenience, or consequential damages.

### **WARRANTY COVERAGE - MATERIALS & WORKMANSHIP**

#### **LIMITED LIFETIME WARRANTY:**

- **STAINLESS STEEL:** Side Steps, Grill Guards, Bull Bars, Bed Caps, and Side Rails
- **ALUMINUM:** Side Steps, Running Boards, Storage Boxes, Transfer Tanks, Bed Protection, Side Rails, Invis-A-Racks, and Cab Racks
- **PLASTIC:** Storage Boxes
- **OTHER:** Front and Rear Bumpers

#### **THREE-YEAR WARRANTY:**

- **POWDER-COATED / E-COATED STEEL:** Side Steps, Running Boards, Storage Boxes, Transfer Tanks, Cab Racks, Sport Bar Ladder Racks, Cargo Carriers, Mounting Brackets (NX, Rough Step, and Bumper Guards only)
- **OTHER:** Tailgate Assist, Bed Mats, Floor Mats, Auxiliary Fuel Connection Kits, and All Products Not Otherwise Listed Individually

### **WARRANTY COVERAGE – FINISH PROTECTION**

The finish of all Dee Zee products is covered for one-year (1) from the date of purchase. Dee Zee products have a high quality finish that must be cared for and maintained like any other exposed finish on the vehicle. Protect the finish with non-abrasive automotive wax (e.g. Pure Carnuba) on a regular basis. Applying soaps, polishes, or waxes that contain an abrasive compound may scratch the finish and leave the exposed material susceptible to corrosion.

### **WARRANTY COVERAGE – COMPONENT PARTS**

Operational items such as shocks, latches, hinges, and wear items including, but not limited to, mud flaps, step pads, toolbox tray, end caps, hardware, seals, etc. have a one-year (1) warranty. Replacement component parts can be ordered via credit card (MasterCard or VISA) by calling 1-800-779-2102. All replacement parts are non-returnable and non-refundable.

## **GPI® FUEL PUMPS & ACCESSORIES**

All Great Plains Industries (GPI) products, including transfer tank pumps and fuel meters are covered by GPI's warranty policies. Dee Zee's warranty terms do not apply to GPI products. To submit a warranty claim, please contact GPI at 1-800-835-0113 or visit [www.gpi.net](http://www.gpi.net).

### **WARRANTY SUBMISSION PROCEDURE**

All warranty claims will be initiated at the place of purchase. The original purchaser will be required to present the original sales receipt with purchase date shown and provide photographs of the defect.

In the event the originally purchased product style is no longer available, Dee Zee will warranty the defective part with a current equivalent. If a comparable product is no longer available, the product would be returned to the store of purchase for a refund or the applicable cost difference can be paid to choose an alternate style.

### **DISCLAIMER**

All products are sold as appearance accessories and should not be relied upon as protection for the vehicle or its occupants in the event of an accident. Vehicles equipped with a supplemental restraints system (air bags) deployed by impact and collision avoidance systems should not be modified in any way. Always consult the vehicle manufacturer if you have any questions regarding supplemental restraint systems and sensors.

Buyer must accommodate front and rear sensors during product installation and assumes all risk should these be tampered, rerouted, severed, or disconnected. This includes disabling visual, audio, or vibration alerts into the cab. Buyer assumes all risk and responsibility for wiring any supplemental auxiliary lights.

Buyer assumes all risk, liability, and cost for the installation and use of Dee Zee products. Dee Zee, Inc. assumes no liability for injury, loss, incidental or consequential damages in the event of an accident.



Thank you for choosing Dee Zee to add function and accessorize your vehicle. Dee Zee has been a staple brand in the truck accessory market since 1977 and we hold a reputation of quality manufacturing based in America's Heartland. Our products are born through careful engineering and backed by industry leading warranty programs. We appreciate the opportunity to serve you and your vehicle!

**Review the instruction pages in their entirety to prepare the required tools**

**Warning:** Please check for wiring or other obstructions before drilling any holes in the vehicle. If it is necessary to drill any holes, Dee Zee recommends putting a sealant or rust inhibitory around all holes drilled into the body of the vehicle.

It is the sole responsibility of the vehicle owner to check for tire clearance. It is unlawful and dangerous to ride on any external vehicle step while the vehicle is in motion.

**Cleaning:** To be entitled to all warranty rights offered with the product, Dee Zee steps need to be cleaned regularly with a mild detergent. Do NOT use abrasive cleaners. For stainless steel products, the application of a high grade automotive wax is recommended.



Dee Zee Cares - Please Recycle

For an electronic version of these instructions visit: [www.deezee.com/instructions](http://www.deezee.com/instructions)

Register your product online: [www.deezee.com/registration](http://www.deezee.com/registration)

# JK Lower Light Bracket Installation Instructions

## DZ 4447JK Jeep Wrangler JK 2007-2018

**A**

Driver Bracket

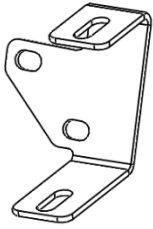

B 2588LP

X1

**B**

Passenger Bracket

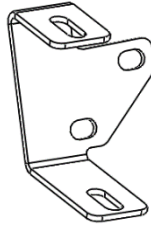

B 2588RP

X1

**C**

Gasket



FGT 49

X1

### Required tools

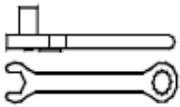

Ratchet / Wrench

Torx 40

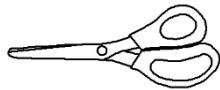

Scissors

**1**

First cut the Gasket (C) into 10 pieces. Lengths are  $2 \frac{7}{8}$ " ,  $2 \frac{1}{4}$ " ,  $1 \frac{3}{8}$ " , 1" ,  $\frac{5}{8}$ ". There will need to be two of each length.

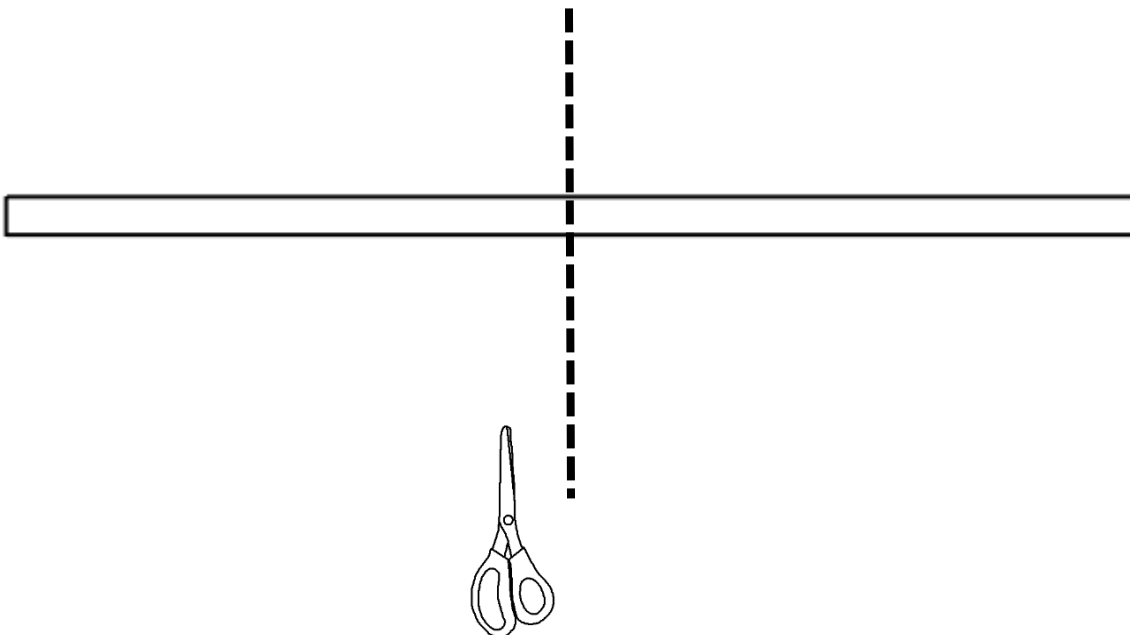

**2**

Peel off the backing of the Gasket (C) and place the gasket on the back side of the Driver side bracket (A) as shown in the picture below.

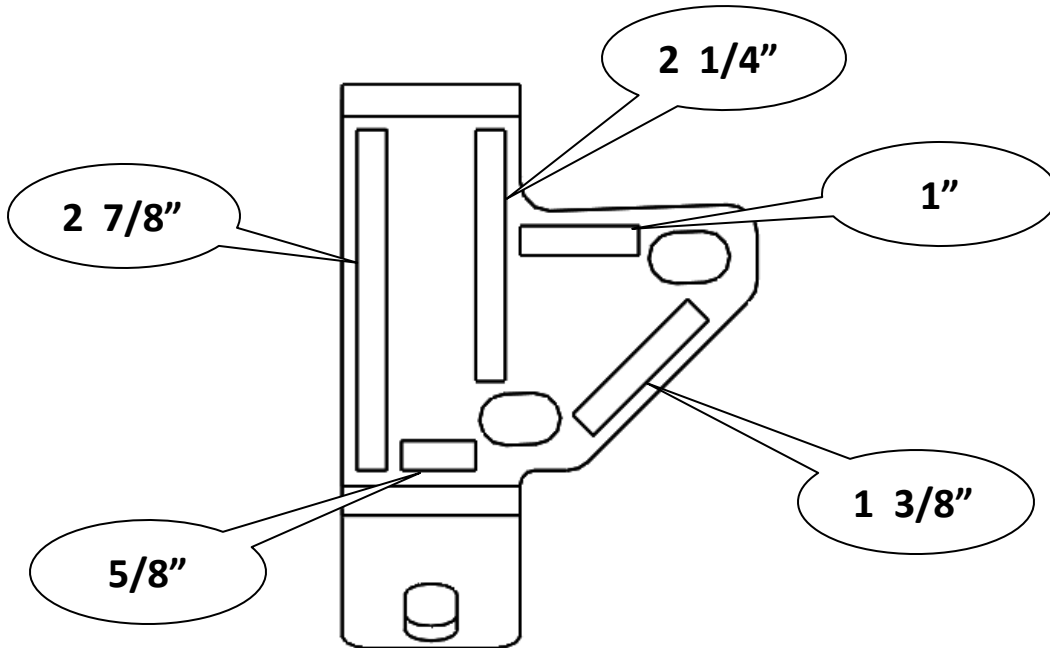

**3**

Remove the two bolts shown in the picture below.

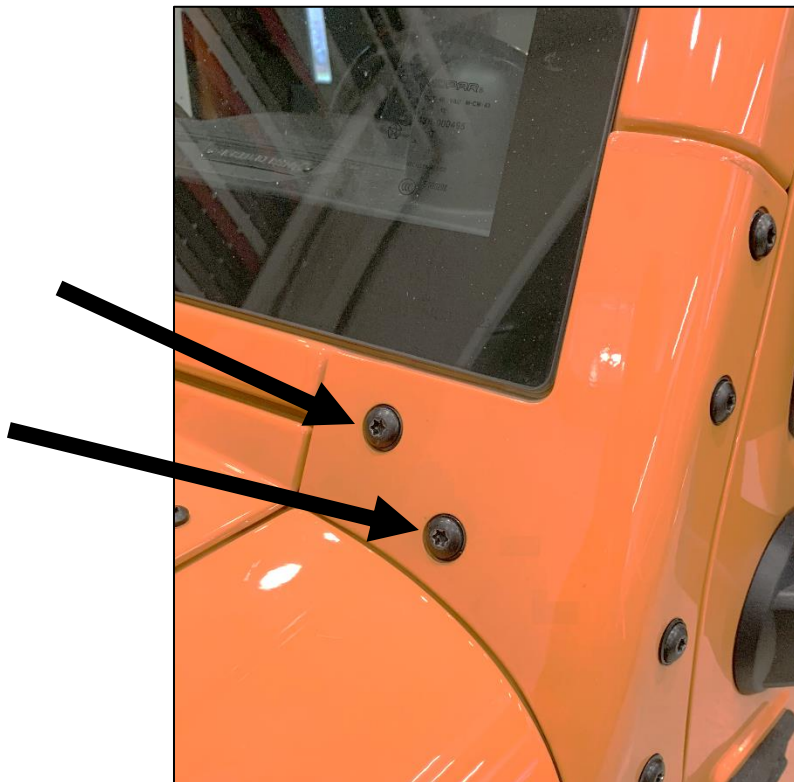

**4**

**Install Driver Bracket with gasket where the bolts were removed and reinstall bolts. Fully tighten hardware at this time.**

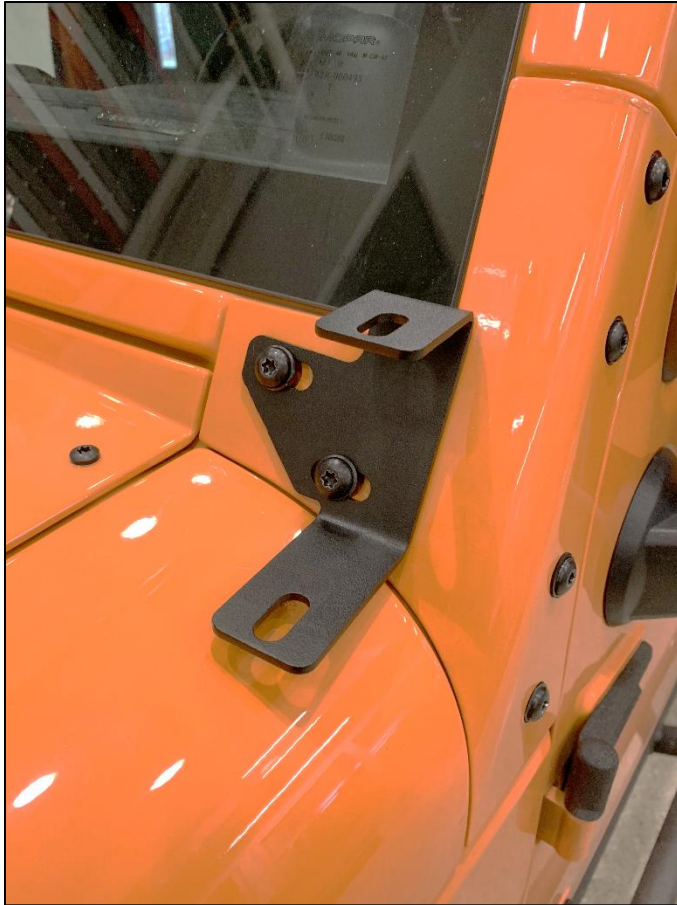

**When Lower Light bracket is mounted the windshield will not be able to be folded down. Brackets A and B are not intended for a Light Bar.**

**Repeat Steps 2-4 on Passenger side Using bracket B instead of A.**