

# Quadratec® QRC Rocker Guards & Side Armor

Installation Manual for 4 Door '07-Current JK Wrangler Vehicles

#12004.3201 & #12004.3211



12004.3201

Rocker Guards

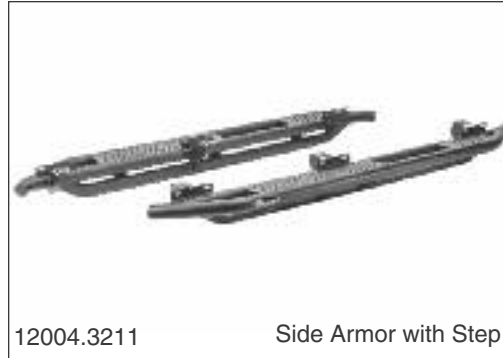

12004.3211

Side Armor with Step



Rocker Guards



Side Armor with Step

**⚠ WARNING ⚠**

TO REDUCE RISK OF SERIOUS INJURY OR PROPERTY DAMAGE: READ ALL SAFETY MESSAGES AND UNDERSTAND ALL INSTRUCTIONS AND PROCEDURE *NOTICES* BEFORE ATTEMPTING TO INSTALL OR USE THIS PRODUCT. FOLLOW ALL INSTRUCTIONS AND WARNINGS WITH PRODUCT & VEHICLE OWNERS MANUAL.

**⚠ CAUTION ⚠**

THIS PRODUCT IS INTENDED TO REDUCE RISK OF OFF-ROAD BODY PANEL DAMAGE AND ASSIST IN ENTRY/EXIT FROM VEHICLE. YOUR TUBE STEP IS NOT INTENDED TO INCREASE OCCUPANT PROTECTION OR REDUCE VEHICLE DAMAGE IN EVENT OF ACCIDENT.

**⚠ CAUTION ⚠**

PROPERLY TORQUE AND RECHECK FASTENERS AND SECURITY OF STEP TREAD AFTER 250 MILES AND FREQUENTLY THEREAFTER. INSPECT AND DO NOT USE AS A STEP IF DAMAGED.

**NOTICE**

CHECK STATE AND LOCAL HIGHWAY SAFETY LAWS REGARDING PERMITTED ON-ROAD EQUIPMENT.



The Trusted Source

**A Few Words About Product Safety:**

Your Rocker Guards are designed to enhance the utility and enjoyment of your off road capable vehicle. Before installation, please take a moment to review the following safety information

and installation instructions. Important safety information is generally preceded by one of three signal words indicating the relative risk of injury.

The signal words mean:

<b>⚠ WARNING ⚠</b>	A hazardous situation which, if not avoided, could result in death or serious injury. You <b>CAN</b> be <b>KILLED</b> or <b>SERIOUSLY HURT</b> if you don't follow instructions.
<b>⚠ CAUTION ⚠</b>	A hazardous situation which, if not avoided, could result in minor or moderate injury. You <b>CAN</b> be moderately <b>HURT</b> and also may suffer property damage if you don't follow instructions.
<b>NOTICE</b>	Careful attention is required to this instruction or operation but does generally not relate to personal injury. Damage to your Quadratec® product or other property may result if you don't follow instructions.

**Before You Begin Installation:**

Congratulations on your purchase of the Quadratec QRC Rocker Guards for your Jeep® Wrangler.

Due to the length and bulk of these guards, we strongly suggest you get the help of a friend for steps that involve lifting, locating or holding the side steps during installation.

When unpacking, check to make sure all parts are included and not damaged due to shipping. If any part is missing or broken, please call Customer Service at 800-745-6037 as soon as possible.

Thank you again for your purchase and let's start the installation process.

<b>NOTICE</b>	As you unpack your rocker guards, be careful not to scratch the finish with a knife or razor. We suggest placing the unpacked guards back into the original box so it does not get scratched before the installation begins. It is highly recommended that a second person assist with the installation of these rocker guards.
---------------	---

**Product Care and Maintenance:**

These custom fit guards have been designed for long life and great looks. With proper care, they are designed to provide years of use.

Please see page 7 in this instruction booklet for all suggested care for your Quadratec Rocker Guards.



**The Trusted Source**

**Installation Hardware:**



**PARTS LIST:**

Driver (Left) Rocker Guard QTY 1  
 Passenger (Right) Rocker Guard QTY 1

**Nut Plates:**

A) 10mm nut plate QTY 6

**Hex Bolts:**

B) 10 x 35 mm bolts QTY 6  
 C) 8 X 35 mm bolts QTY 6

**Button Head Bolts:**

D) 6 X 25mm button head bolts QTY 12

**Nylon Lock Nuts:**

E) 6mm nylock nut QTY 12

**Flat Washers:**

F) 10mm flat washer QTY 6  
 G) 8mm flat washer QTY 6  
 H) 6mm flat washer QTY 24

**Lock Washers:**

I) 10mm lock washer QTY 6  
 J) 8mm lock washer QTY 6

**Supplied Tools:**

K) 4mm Hex Key QTY 1

**REQUIRED TOOLS:**

Safety Glasses  
 10mm, 13mm & 16mm Sockets  
 with Ratchet Driver

**NOTICE**

You can identify the left and right hand pieces by locating the Quadratec oval logo. The logo should be at the front of the part.

**NOTICE**

You must remove factory installed "Rock Rails", side steps or running boards before installation of your new rocker guards.

**NOTICE**

These instructions are shared for the Quadratec side steps and Quadratec rock rails for JK. The installation instructions are the same for both. Pictures may not show the part you purchased but the installation will be the same.



**The Trusted Source**

**Step 1:**

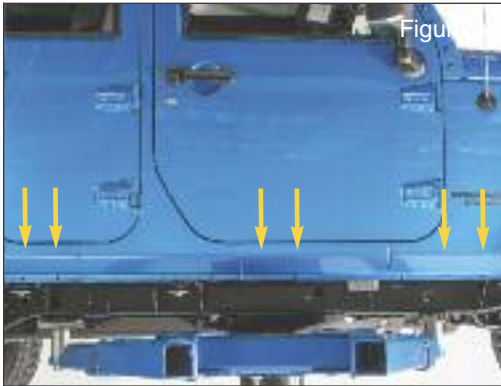

Locate the 6 holes along the factory pinch weld of your vehicle as show in picture. (Figure 1)

**Step 2:**

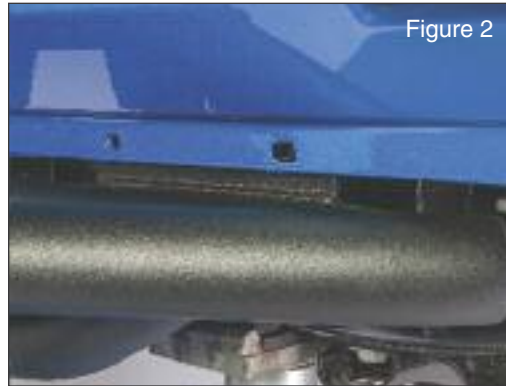

Starting at the front of the vehicle position the mounting tabs of the rock rails behind the pinch weld and align the holes with the factory pinch weld holes as shown. (Figure 2)

**Step 3:**

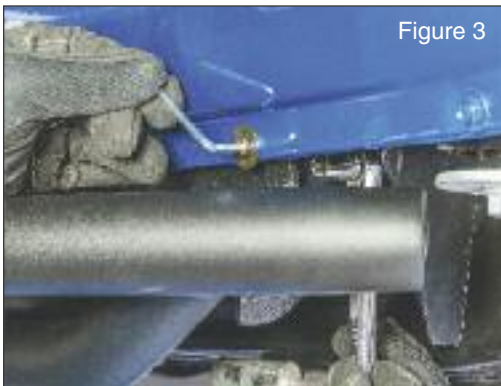

Install the 6mm button head bolts through the pinch weld and the mounting bracket with a washer on both sides and secure with 6mm nylock nut using the provided 4mm hex wrench and a 10mm socket. (Figure 3)

**Step 4:**

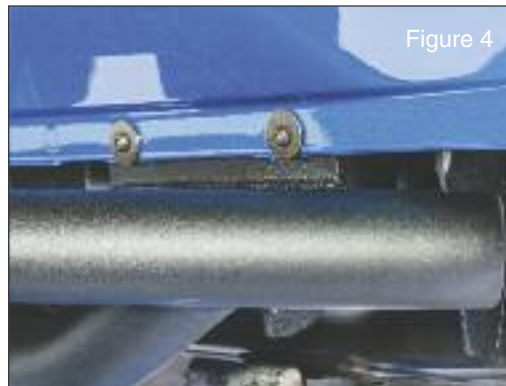

Do not fully tighten at this time. Repeat on the 5 remaining holes. (Figure 4)



**The Trusted Source**

**Step 5:**

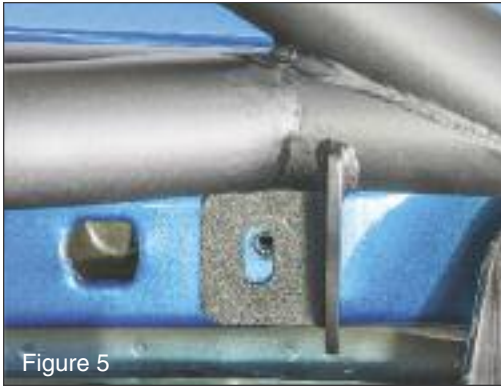

*On Newer model JK's locate the 2 vertical threaded holes behind the pinch welds. Align the holes in the brackets with these holes. (Figure 5)*

**Step 6:**

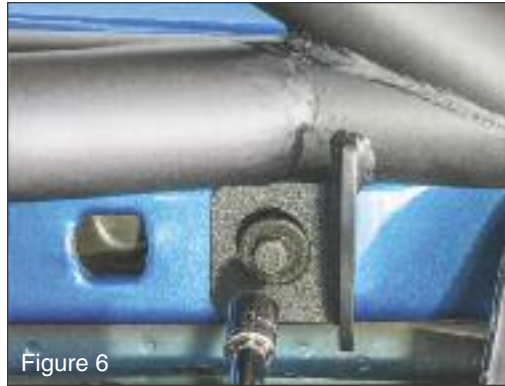

*Install the 8mm hex bolts, lock washers, and washers and snug with a 13mm socket. Repeat on the two remaining holes. (Figure 6)*

**Step 7:**

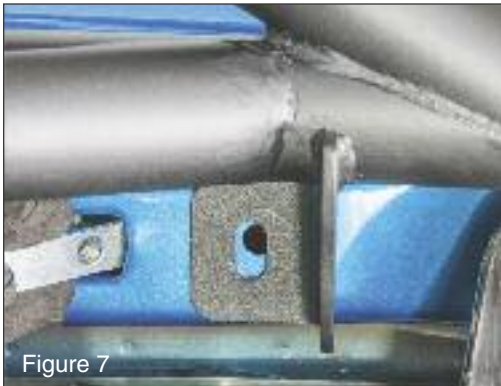

*Older JKs do not have a threaded insert. The supplied 10mm nut plate will have to be installed through the adjacent hole in the body.*

*You may have to hold the plate in position using a finger. (Figure 7)*



*Once the plate is installed secure with 10mm bolt, lock washer, and washer. Snug with a 16mm socket. (Figure 8)*

*Now fully tighten the pinch weld bolts and then the vertical mounting bolts. Repeat steps on the opposite side.*

*Installation is complete.*



**The Trusted Source**



**Completed Installation:**

Rocker Guards



Side Armor with Step



**The Trusted Source**

**Product Care and Maintenance:**

Your Rocker Guards have been designed and manufactured to provide years of use. However, like any product, general maintenance is required to keep it looking new.

Because the guards are located on the underside of the vehicle, they are

subject to potential rock chips and other debris potentially causing portions of the paint to chip off. For touch ups, we recommend using a textured black spray paint sprayed on a piece of cardboard and cotton swab to gently fill in these chips. This will prevent any rust from forming.



**The Trusted Source**

# Quadratec® Exclusive Three Year Limited Warranty

Your Quadratec® branded accessories are covered by the following **Limited Warranty** provided exclusively by Quadratec, Inc., 1028 Saunders Lane, West Chester PA 19380.

This **Limited Warranty** is the only warranty made in connection with your purchase. Quadratec neither assumes nor authorizes any vendor, retailer or other person or entity to assume for it any other obligation or liability in connection with this product or **Limited Warranty**. This **Limited Warranty** does not apply and is not cumulative to any accessory or part distributed by Quadratec for which the Manufacturer provides a separate written warranty.

**What is Covered:** Subject to the terms, exclusions and limitations herein and with respect only to Quadratec branded accessories first sold in the United States, Quadratec warrants to the initial retail purchaser only that your Quadratec accessory shall be free of defects in material and workmanship: **for a period of three (3) years from date of retail purchase.**

This **Limited Warranty** is not assignable and shall terminate upon sale of the vehicle upon which the Quadratec accessory is installed or other transfer third persons.

All other warranties are hereby disclaimed, except to the extent prohibited by applicable law in which case any implied warranty of merchantability or fitness for a particular purpose on this product is limited to 3 year from date of initial retail sale. Quadratec reserves the rights to: (a.) require invoice or other proof your accessory is within the terms of this **Limited Warranty** as a condition of warranty service and, (b.) make future revisions to this product and **Limited Warranty** without prior notice or obligation to upgrade your product.

**What is Not Covered:**  
Your Quadratec **Limited Warranty** does not cover products or parts Quadratec determines to have been damaged by or subjected to:

(a.) installation damage, alteration, modification, combination with other parts, failure to maintain or improper repair or service, (b.) normal wear & tear, cosmetic damage or damage from moisture or water immersion, (c.) Acts of God, accidents, misuse, negligence, inadequate mounting or impact with vehicle(s), obstacles or other aspects of the environment, (d.) theft, vandalism or other intentional damage.

**Remedy Limited to Repair/Replacement:**  
The exclusive remedy provided hereunder shall, upon Quadratec inspection and at Quadratec's option, be either repair or replacement of product or parts (new or refurbished) covered under this **Limited Warranty**. Customers requesting warranty consideration should first contact Quadratec to obtain a RGA number (610-701-3336). All labor, removal, shipping and installation costs are customer's responsibility.

#### **Other Limitations - Exclusion of Damages - Your Rights Under State Law:**

In consideration of the purchase price paid, neither Quadratec nor any independent Quadratec distributor/licensee are responsible for any time loss, rental costs, or for any incidental, consequential, punitive or other damages you may have or incur in connection with any part or product purchased. Your exclusive remedy hereunder for covered parts is repair/replacement as described above.

This **Limited Warranty** gives you specific rights. You may also have other rights that vary from state to state. For example, some states do not allow limitations of how long an implied warranty lasts and /or do not allow the exclusion or limitation of incidental or consequential damages, so the limitations and exclusions herein may not apply to you.

©Quadratec, Inc. 2013. All Rights Reserved.  
3.29.13 LTR Version

Part #12999.3059



**The Trusted Source**