

# QuadraTop® Fabric Replacement Soft Top

## Installation Manual for '07-'18 2-Door Wrangler (JK)

Items: #11000.4035, #11000.4335, #11000.4935, & #11000.4735



### **⚠ WARNING ⚠**

Loss of vehicle control involves risk of death or serious injury, particularly to parts of your body not restrained within vehicle. This product is intended for weather protection only and should not be relied upon to contain occupants in the event of an accident or to protect from either ground contact or falling objects. To reduce risk of accident or injury:

- **ALWAYS WEAR SEATBELTS**
- Always keep head, arms & body parts within vehicle.
- Fully secure or stow the soft top before driving according to instructions. Never try to latch or fold soft top while driving. Do not use if damaged or worn.
- Read and follow all instructions & warnings accompanying this product, in your vehicle owner's manual and Off Road Driving Supplement.

### **⚠ CAUTION ⚠**

**RISK OF EYE INJURY.** Safety glasses should be worn at all times while installing or maintaining this product.

#### **PARTS LIST:**

FABRIC TOP - QTY 1  
QUARTER WINDOW, RIGHT - QTY 1  
QUARTER WINDOW, LEFT - QTY 1  
REAR WINDOW - QTY 1  
EARLY JK CONVERSION KIT  
(07-09 MODELS ONLY) - QTY 1  
HEADER FOAM PACK - QTY 1  
FABRIC SPRING GUARDS - QTY 2

#### **REQUIRED TOOLS:**

SAFETY GLASSES  
MASKING TAPE  
PHILLIPS SCREW DRIVER  
T-15 TORX DRIVER OR BIT  
PLIERS  
T-30 TORX DRIVER OR BIT  
(07-09 MODELS ONLY)



**The Trusted Source**

**Important Safety Information:**

Your QuadraTop® soft top is intended to increase the utility and enjoyment of your off-road capable vehicle. Before installation, please take a moment to review the following safety information

and installation instructions. Important safety information is generally preceded by one of three signal words indicating the relative risk of injury. The signal words mean:

|                    |   |
|--------------------|---|
| <b>⚠ WARNING ⚠</b> | a hazardous situation which, if not avoided, could result in death or serious injury. You CAN be KILLED or SERIOUSLY HURT if you don't follow instructions.   |
| <b>⚠ CAUTION ⚠</b> | a hazardous situation which, if not avoided, could result in minor or moderate injury. You CAN be moderately HURT and also may suffer property damage if you don't follow instructions.                           |
| <b>NOTICE</b>      | Careful attention is required to this instruction or operation but does generally not relate to personal injury. Damage to your Quadratec® product or other property may result if you don't follow instructions. |

**Before You Begin Soft Top Installation:**

Congratulations on your purchase of the QuadraTop! This high quality soft top is designed to provide years of protection from whatever nature can throw at you! We have used only the finest materials in creating this soft top but like any product that is exposed to the elements, there is some general maintenance that is required to keep your QuadraTop looking like new. Please see page 18 for these important maintenance tips as well as page 3 for available hardware components that may have been lost or worn over the years.

Thank you again for your purchase and let's start the installation process!

When unpacking, check to make sure all parts are included. If any part is missing or broken, please call Quadratec Customer Service at 800-745-6037 as soon as possible.

**Important:** Make sure you become familiar with the installation process of this top by reading the following instruction sheet thoroughly.

|               |  |
|---------------|--|
| <b>NOTICE</b> | This product is designed to fit over your original factory soft top hardware. Please see the image below to make sure you have the complete and correct hardware for this top. |
|---------------|--|



**Important:** Existing soft top hardware required to install this top. Check to make sure your hardware looks like the picture to the left.



**The Trusted Source**

## Pre-installation & Initial Steps:

### NOTICE

For a smooth fit and ease of installation, this top should be installed at temperatures above 72 degrees. Below this temperature, the fabric may contract an inch or more making it difficult to install. We highly recommend taking the top out of the package and letting it sit inside a warm place or direct sunlight for 1-2 hours before you install the top. When warm, this top will install quickly.

Please also note that it is normal for fabric to contract and wrinkle when stored in the shipping carton. In a few days the fabric will relax and wrinkles will disappear.

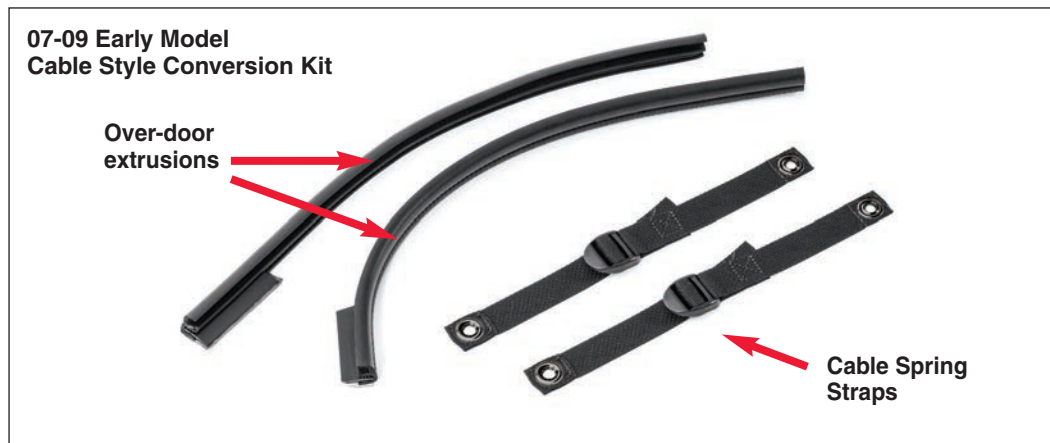

**Special Note: for 07-09 Wrangler only**  
If you have a 07-09 JK Wrangler you will be using the enclosed conversion kit to install your top. This kit turns your regular top into a "cable style top" making it easier to fold the top back.

This conversion kit is only included in 07-09 Applications. Note: The photo shows grommets on each end of the spring straps. The one end of the strap may have a "D" Ring installed instead of a grommet.

## Replacement Hardware & Soft Top Accessories available at [Quadratic.com](http://Quadratic.com)

Please review this set of instructions, and examine your original equipment hardware. Is any hardware missing or damaged? Quadratic offers a full assortment of original equipment hardware and accessories to keep your top looking new and performing at its peak. The following parts and current pricing are available at [Quadratic.com](http://Quadratic.com)

- > Complete Bow Assemblies: #11132.95XX
- > Soft Top Emergency Repair Kit: #91083.4201
- > Zipper Slick Zipper Lubricant: #91083.4200
- > Soft Top Cleaner & Protectant: #91083.110X
- > Soft Glass Window Polishes: #91083.11XX

Don't see what you need on the list?  
Call for Expert Advice at 800-745-5337

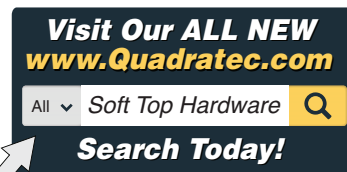

The Trusted Source

## Soft Top Installation:



**Step 1A: Remove Existing Top Fabric**  
*Remove your existing Soft top Fabric. After verifying that you have the correct factory original bow system and hardware, remove the existing soft top from the vehicle. This process will entail removing all Quarter windows, unscrewing the top from the rear bows and removing the fabric from the windshield header by unscrewing 19 or 27 header*

*screws (Depending on model year). See Step 1b on next page for proper removal of header fabric. Make sure you keep all screws and fasteners in a safe place after removal. You will be using them again later in the installation.*

*See Figs 1, 2, 3 & 4. Once the soft top is removed, inspect all of your hardware to make sure no parts are bent or missing.*

### NOTICE

**The following header installation will be easier to accomplish with the help of another person. This step will most likely be the most difficult step in the install and you should take your time. The easiest way to install this header is standing on the front seats facing forward.**

**We suggest placing a towel or cover on the seats to protect them from dirt and debris from your shoes. Once the soft top header fabric is installed in the factory header, the remaining installation should be very straight forward.**



**The Trusted Source**

**Soft Top Installation:**



**Step 1B: Remove Existing Top Fabric**  
Detach your old Soft Top Fabric from the Header. **For Model Years 2010-2018 Only:** You will need to peel back the corner foam and unscrew the cable attachment on both ends of the header using a T-15 Torx.

**For Model Years 2007-2009 Only:** You will need to peel back the foam and remove the two corner screws that hold a plastic mounting flange that hold a plastic mounting flange located in the same vicinity. See Figs 5, 6, 7 & 8.



**The Trusted Source**

## Soft Top Installation:



### Step 2: Install the New Top Fabric to the Windshield Header

With the old top completely removed and the top header plate unscrewed from the lower header, raise the bow assembly and lock the header to the windshield (See Fig 9).



As seen in Fig 10, drape the soft top fabric backing side up over the hood and the windshield and locate the front extrusion sewn into the front header of the Top. Locate the masking tape and have it ready for step 3.

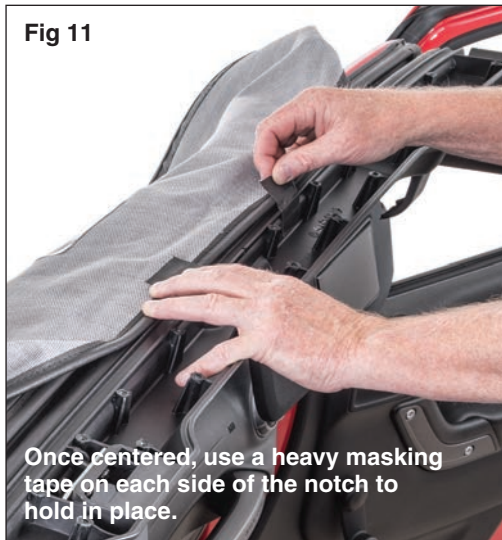

### Step 3: Center New Fabric on Windshield Header with Tape

Slide the sewn in extrusion along the front edge of the top into the channel of the lower header that is secured to the windshield in step one (See Fig 11).



Locate and line up the center notch in the middle of the fabric to the center of the channel centering the fabric on the lower header. Secure the fabric around the center notch with masking tape. See Fig 12.



**The Trusted Source**

## Soft Top Installation:



**Step 4: Secure Top in Lower Header**  
*Working from the center out, secure the top in the lower header channel with masking tape holding it in place for installing the top plate to the lower header. Use 5-6 pieces of tape to hold the top in place. Note: The tape pieces will be completely covered when the top plate is put back on the lower header. See Figs 13, 14 & 15.*



**Step 5: Reassemble Lower Header**  
*Close the upper header over the taped down fabric sandwiching the fabric but leaving the underside faced up on the hood (See Fig 16). Using the screws you removed in step one, reinstall the four corner screws and then the 19 or 27 (depending on model year) screws along the top of the header. See Figs 17 & 18. Un-latch the bow assembly from the windshield (inside vehicle) and lower the bow assembly to the rear of the vehicle folding the top back over with the underside of the fabric facing down (see Fig 19).*



**The Trusted Source**

**Installation:** Note: Figs 20 & 21 bows folded back to rear of vehicle. Rear corner shown.



**Step 6: Header Corner Pockets**

*Slip the corner pocket sewn into the top between the header and position the cable anchors over the two holes with the cable facing the outside of the header (Fig 20 & 21).*

*Note: on 07-09 models the screw holes may not line up exactly and some hole relocation may be required using a drill. Reinstall cable anchor screws on each side of the header as shown in Fig 21.*

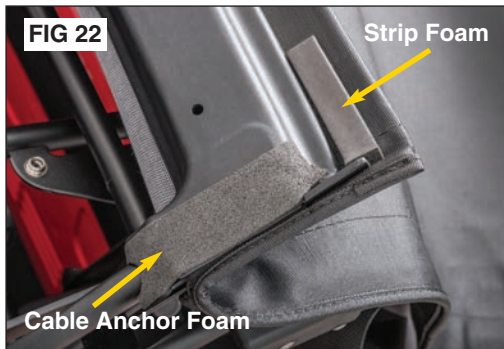

**Step 7: Install Header Foam**

*Locate the Header foam packet and attach foam over the installed cable anchors on each side of the header. Install the small "strip" foam on the front of the header as shown in Fig 22.*



**Step 8: Drape the Top Fabric**

*Drape the top fabric over the cab re-installing and securing the bow assembly above the door. The front header should be resting on the windshield but not attached/clamped and the top fabric should be laid back but not attached to the rear bows. See Fig 23*



**The Trusted Source**



## Soft Top Installation: Year-Dependent Cable Spring Variable Steps

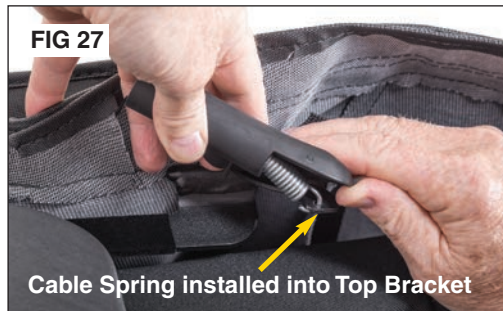

### Step 9: For '10-'18 JK 2-Door Vehicles

#### Securing the Cable Spring

Locate the Cable spring hanging out of the top behind the rear seat next to the rear vertical door surrounds. Fold back the front header to reduce the side cable tension. On 2010-2012 models the rear bracket where the cable spring is to be attached is exposed or under a fabric sleeve. With the front header tension released, attach the spring to the bracket and using a set of pliers,

### For '07-'09 JK please skip to step 9A

crimp the spring end closed so it cannot be easily slipped off (see call out on Figs 26 & 27). For 2013-2018 JK models the bracket is encased in a plastic "tube". As shown in Figs 24-27, slip the cable spring through the "tube" and attach it to the top bracket and using a set of pliers, crimp the spring end closed so it cannot be easily slipped off. Step 10 resumes on page 12.

#### NOTICE

We have enclosed new fabric covers to cover the attached spring mechanism. These can be used on 2010-2012 vehicles to cover the spring or on 2013-2018 vehicles if the plastic "tube" is damaged during original soft top removal.



The Trusted Source

## Soft Top Installation: '07-'09 Cable Spring Steps for JK 2 Door

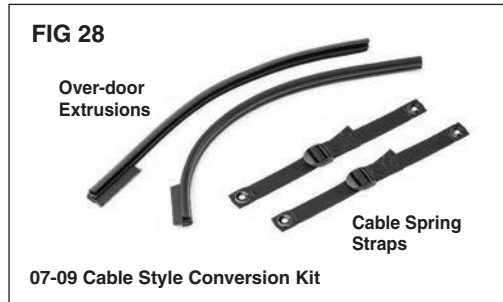

### Step 9A: Securing the Cable Spring

Locate the early model conversion kit. With the front header resting on the windshield and the remainder of the top draped over the rear bows, fold back the front header to reduce tension in the cable. Locate the Cable spring hanging out of the top behind the rear seat next to the rear vertical door surrounds.

Locate the Cable spring straps (fig 28) and loosely thread the long strap through the buckle as shown in Fig 29 so that there is a grommet one end and a "D" ring on the other end of the combined strap. Attach the short strap end with the "D" Ring to the cable spring and using a set of pliers, crimp the spring end closed so it can not be easily slipped off.



Attach the other end of the strap with the grommet (remove top bracket bolt with a T-30 Torx, slip bolt through Grommet and re-attach) to the outside bolt hole where the sound bar is installed. See Fig 30. Repeat for the opposite side of top.

#### **CAUTION**

Do not tighten the side cable spring strap at this time. The front header must be closed and locked before you tighten the cable spring straps!

#### **WARNING**

When installing the strap make sure you do not hinder the use of the seat belt. The strap should go inside the vehicle under any seat belt strap.



**The Trusted Source**

## Soft Top Installation: '07-'09 Cable Spring Steps for JK 2 Door

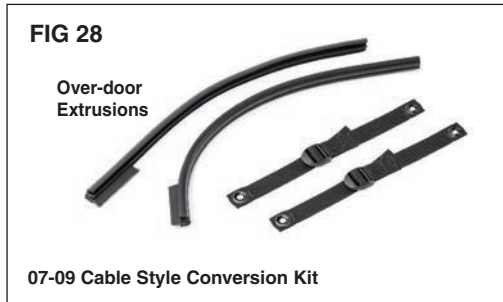

### Step 9B: Secure Over-Door Extrusions

*The cable sewn into the top needs to rest inside of a "rain gutter" to seal properly. This step installs the rain gutter "extrusion" to your hardware. Locate the Front Over Door Extrusion (See fig 28). Line up the rear extrusion with the gap in the hardware and slowly but firmly push the extrusion up into the lip of your door surrounds.*

*The soft lip should be facing up and the small plastic strip should fill in the gap on the door surround hardware. Work your way back towards the rear of the vehicle securing the extrusion along the way. See Figs 32-34.*



**The Trusted Source**

## Resume Normal Soft Top Installation: Non-Year Specific



### Step 10: Reinstall Center Bow Screws

Flip the rear of the top forward exposing the center Bow. Install the hook & loop Flap that attach the center bow.

(Bow #1 over the sound bar).  
See Fig 35

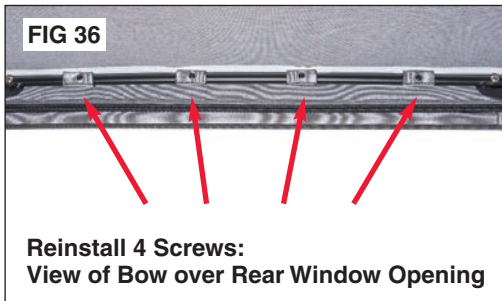

Reinstall 4 Screws:  
View of Bow over Rear Window Opening



### Step 11: Reinstall Rear Bow Screws

Reinstall the 4 screws that attach the rear bow (Bow #2 over rear window opening). These screws are the ones previously removed from your original

top. On some models the straps may have to wrap around the opposite side of the bow. Regardless, the bow straps should be tight. See Figs 36 & 37.

**READ BEFORE PROCEEDING TO STEP 12:** On some Tops the rear bow flap is one piece. The pictures in Fig 36 & 37 above shows the rear bow flap as "tabs". For Step 12 below, If the Soft top is too tight and the corners are loose, or if the top is too loose and the corners too tight you may need to un-screw the screws in Step 11 and re-screw them to the flap to adjust the top and corner attachments. Also, if there are small "puckers" that form on the rear seam after the front header is secured, we suggest unscrewing and reinstalling the rear bow screws after step 19 with the rear window installed



### Step 12: Secure Rear Corners

With all the bows attached to the top, and the front header folded back toward the rear of the vehicle, gently pull down

on the rear bow while securing the rear corners into the retainers on the vehicle. See Figs 38 & 39



**The Trusted Source**

## Soft Top Installation:



### Step 13: Securing Top Front to Windshield

With the cable spring installed, with two people (one on each side of the header) fold down the header to the windshield and close the front header latches to secure the front of the top to the windshield. See Figs 40-42.

***Please Note:*** If you fold down your front header and it is **EXTREMELY TIGHT**, **STOP**. If too tight, you will need to un-screw the rear bow screws, fold down the header and then re-install the rear bow screws. This will prevent damage to your soft top hardware.

***We highly recommend that two people fold down the header simultaneously. This will prevent possible damage to the hardware system.***

*For 07-09 applications only: With the front Headers latched, tighten the side spring cable straps. See Fig 43.*

### **CAUTION**

The leading edge of the soft top must be secured to prevent the loss of the top at speed. Latches must be fully closed and free of mud and other contamination. Do not use top if either latch is damaged.



**The Trusted Source**

**Soft Top Installation:**



**Step 14: Attach Quarter Window Zippers**  
*Attach the quarter window zippers by starting the zipper on the quarter window and zipping it closed 2-3*

*inches. Repeat this on the other side of the vehicle. See figs 44 & 45*



**Step 15: Front of Quarter Windows**  
*Attach the front of the quarter windows along the front edge of the vertical door surround by rolling the plastic into the slot on the door surround.*

*Repeat on the opposite side of the top. See Figs 46 & 47.*



**The Trusted Source**

**Soft Top Installation:**



**Step 16: Secure The Bottoms of the Quarter Windows**

*Roll the bottom of the quarter window into the retainer channel on the vehicle and then close the quarter window zipper the rest of the way. Close up the hook and loop fasteners around the zippers. See Figs 48, 49, 50.*



**Step 17: Elastic Window Roll Straps**

*Snap the elastic window roll straps on the rear bow above the rear window opening as shown.*

*These handy straps can be used to secure your rear window when rolled up. See Figs 51 & 52*

**NOTICE**

**Before Rolling up the rear window, make sure the glass is clean. Dirt and Debris can cause window scratches when rolled up.**



**The Trusted Source**

**Soft Top Installation:**



**Step 18: Prepare Rear Window**

*Locate the rear window and place it on a soft surface with the backing side up. Take the factory bar removed in step one and orient the "C" Channel with the round seal facing down and slide the "C" Channel onto the rear window retainer as shown in Figs 53 & 54.*

*After sliding the retainer all the way through the "C" Channel, roll the tail-gate bar into the mounts with the outside of the fabric facing towards the rear of the vehicle. See Figs 55 & 56.*



**The Trusted Source**



## Soft Top Installation:



### Step 19: Secure Rear Windows

Secure the rear window zippers by pulling the two zipper sliders all the way down as far as possible in order to catch the sliders on the zipper pin. Once the zipper is caught, raise the zipper 1"-2". Hold the top of the window with one hand and zip up the zipper all the way with the other hand. Make sure that the tailgate bar is centered.

If the zippers have too much distance between the window and the top, slide the rear corners around towards the middle of the vehicle until the zippers can be closed. See Figs 63 & 64. Tuck the flaps under the window zippers into the retainers to secure the rear window. See Figs 65 & 66.

*Top Installation is now complete!*

### **⚠ WARNING ⚠**

When operating the vehicle with the quarter windows removed, the rear window should be rolled up and secured with the elastic straps or completely removed for proper ventilation.



**The Trusted Source**

### Care and Maintenance:

Your QuadraTop is made of the finest materials available but to keep it looking new and for the maximum possible wear, it will need periodic cleaning and basic maintenance. The main threats to your soft top are pollutants, dirt and grime. By keeping your soft top clean you will prolong the life of your top. We recommend the following to keep your top like new:

**Washing:** The soft top fabric should be washed often using a mild soap, warm water and a soft bristle brush (do not use the brush on the window glass!). You can also use special soft top cleaners available on our website and shown on page 3. Make sure that after cleaning you rinse with clear water to remove all traces of soap.

**Zippers:** Keeping the zipper cleaned and lubricated with a silicone lubricant (see Page 10) will help prevent damage and keep the zippers in a smooth working condition. If zipper opens behind the slider, the slider may have been spread apart. This problem can usually be fixed

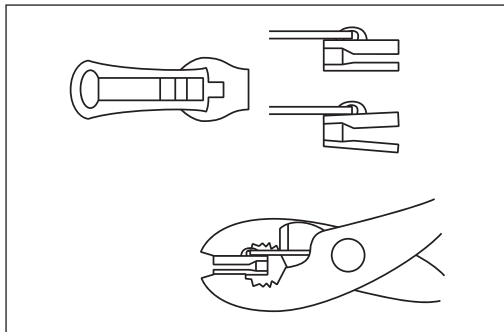

by using an ordinary pair of pliers to bring the sides back into parallel. Return slider to the end of the zipper in the normal Open position. Squeeze lightly at

first and test zipper. If the zipper continues to remain open squeeze more firmly with pliers and try the zipper again. Repeat procedure until your zipper operates correctly.

**Windows:** It is very important that you keep your QuadraTop windows clean! Use a mild soap and water solution to gently clean your windows. NEVER wipe your windows clean with a dry cloth! Dust and dirt on a dry cloth can scratch your windows causing “fogging” and permanent damage. When removing your windows, store them with a towel between the panels/rear windows to protect them from damage. If frost or ice forms on the outside of your windows during the winter, DO NOT use an ice scraper to remove this frost. Over time you will see small micro scratches in your windows which are natural wear and tear. These Micro scratches can be “polished” out using the window polish listed on page 10 (Available at Quadratec.com).

**Water/Fabric:** In the event of seeping through the seams, 3M Scotchgard® may be applied on the inside of the seams to stop the see. Rips in the fabric may be repaired with Bondex® iron on patches. Iron the patches to the Inside of the top, carefully following the Bondex® instructions.

**Snaps:** Keep snaps cleaned and lubricated with silicone to help prevent snaps from sticking to the studs. If a snap does become stuck to a stud, use a screwdriver and GENTLY pry apart to prevent permanent damage to the snap or the top fabric.



**The Trusted Source**

**Installation Complete:**



**Flip-Back Front Open:**



**QuadraTop®**



**The Trusted Source**

# Quadratec Limited Warranty

## for QuadraTop® Replacement Soft Tops

Your QuadraTop® replacement soft top is covered by the following **Limited Warranty** provided exclusively by Quadratec, Inc. 1028 Saunders Lane, West Chester, PA 19380.

This **Limited Warranty** is the only warranty made in connection with purchase. Quadratec neither assumes nor authorizes any vendor, retailer or other person or entity to assume for it any other obligation or liability in connection with this product or **Limited Warranty**.

### **What is Covered:**

Subject to the terms, exclusions and limitations herein and with respect only to soft tops first sold in the United States, Quadratec warrants to the initial retail purchaser only that your QuadraTop soft top shall be free of defects in material and workmanship **for a period of 3 years from date of initial retail sale.**

All other warranties are hereby disclaimed, except to the extent prohibited by applicable law in which case any implied warranty of merchantability or fitness for a particular purpose on this product is limited to 3 years from date of initial retail sale. Quadratec reserves the rights to: (a.) require invoice or other proof your soft top is within the terms of this **Limited Warranty** as a condition of warranty service and, (b.) make future revisions to this product and **Limited Warranty** without prior notice or obligation to upgrade your soft top.

### **What is Not Covered:**

Your Quadratec **Limited Warranty** does not cover products or parts Quadratec determines to have been damaged by or subjected to: (a.) installation damage, alteration, modification, failure to maintain or attempted repair or service by anyone not authorized by Quadratec, (b.) normal wear and tear, cosmetic damage or damage from water immersion, (c.) Acts of God, accidents, misuse, negligence, inadequate mounting or impact with vehicle(s), obstacles or other aspects of the environment, (d.) theft, vandalism or other intentional damage.

### **Remedy Limited to Repair/Replacement:**

**The exclusive remedy provided hereunder shall, upon Quadratec inspection and at Quadratec's option, be either repair or replacement of product or parts (new or refurbished) covered under this Limited Warranty.** Customers requesting warranty consideration on QuadraTop soft top should first contact Quadratec to obtain a RGA number (610-701-3336). All labor, removal, shipping and installation costs are customer's responsibility.

### **Other Limitations - Exclusion of Damages - Your Rights Under State Law:**

In consideration of the purchase price paid, neither Quadratec nor any independent Quadratec distributor/licensee are responsible for any time loss, rental costs, or for any incidental, consequential, punitive or other damages you may have or incur in connection with any part or product purchased. Your exclusive remedy hereunder for covered parts is repair/replacement as described above.

This **Limited Warranty** gives you specific rights. You may also have other rights that vary from state to state. For example, some states do not allow limitations of how long an implied warranty lasts and/or do not allow the exclusion or limitation of incidental or consequential damages, so the limitations and exclusions herein may not apply to you.

The terms Quadratec®, QuadraTop® Essentials® and Essential® are Registered Trademarks of Quadratec Inc. Registered in U.S. Patent and Trademark Office.

©Quadratec, Inc. 2018. All Rights Reserved.  
Version 12.5.18 LTR

Part #12999.0215



**The Trusted Source**