

## INSTALLATION INSTRUCTIONS

### Universal Radar Blind Spot System

(Part # RDBS-1500)

Please read thoroughly before starting installation and check that kit contents are complete.

Please read thoroughly before starting installation and check that kit contents are complete.

**Items Included in the Kit:**

- 1 Bumper/Radar Harness
- 1 Interior/Chassis Harness
- 22 ga. White, Brown, and Yellow Wire (4 feet)
- 22 ga. Light Green and Red Wire (10 feet)
- HMI Display Set (includes left and right side & 2 retaining clips)
- Piezo Buzzer
- Integration CAN ECU
- BSD Radar Sensors (24 GHz left and right)
- 8 1/8-inch Black Heat Shrink
- Fuse Holder and 3 amp fuse
- 12 Zip Ties
- 1 Z-Tech rust inhibitor
- 2 Universal Mounting brackets
- 6 3/4-inch stainless steel Phillips screws
- 6 Nyloc stainless steel nuts
- 12 5mm stainless steel washers
- 8 self-tapping 1/4-inch drive screws
- Protractor

**Tools & Supplies Needed:**

- Electrical tape
- Zip ties
- 1" Hole Saw
- 3/16" Drill Bit
- Digital Volt Meter / BCM safe test light
- Screwdriver
- Socket set
- Wrench



## INSTALLATION INSTRUCTIONS

### Safety Precautions:

- Work in well ventilated area that is clear of obstructions.
- Secure vehicle with tire chucks in both front and rear of tires.
- Turn vehicle accessories OFF and ensure ignition key is in OFF position.
- Wear safety goggles and snug fitting clothes.
- Use tools only for their intended purpose and which are in good repair.
- Only perform this task if confidence, skill, and physical ability permit.

**NOTE: We strive to provide accurate and up-to-date installation instructions. For the latest full color instructions, as well as an installation video, please visit [www.brandmotion.com](http://www.brandmotion.com)**

### INSTALLATION:

1. When installing the radar modules, use the recommended smartphone app (or the included protractor) to check the angle for the radar modules. Brandmotion recommends **45 degrees** from the back of the vehicle as optimal, but can be between 42 to 48 degrees. The elevation angle (or "pitch") from top to bottom should be between **1 to 3 degrees**.
2. The LEFT radar module is for the driver's side and the RIGHT radar module is for the passenger side. Both modules should be installed with the black side facing the exterior of the vehicle and connectors facing down toward the ground.
3. The vehicle wiring harness will run down the left side of the vehicle. For the radar module wiring harness, connect the shortest length wired connector to the LEFT radar module and the longer wired connector to the RIGHT radar module.

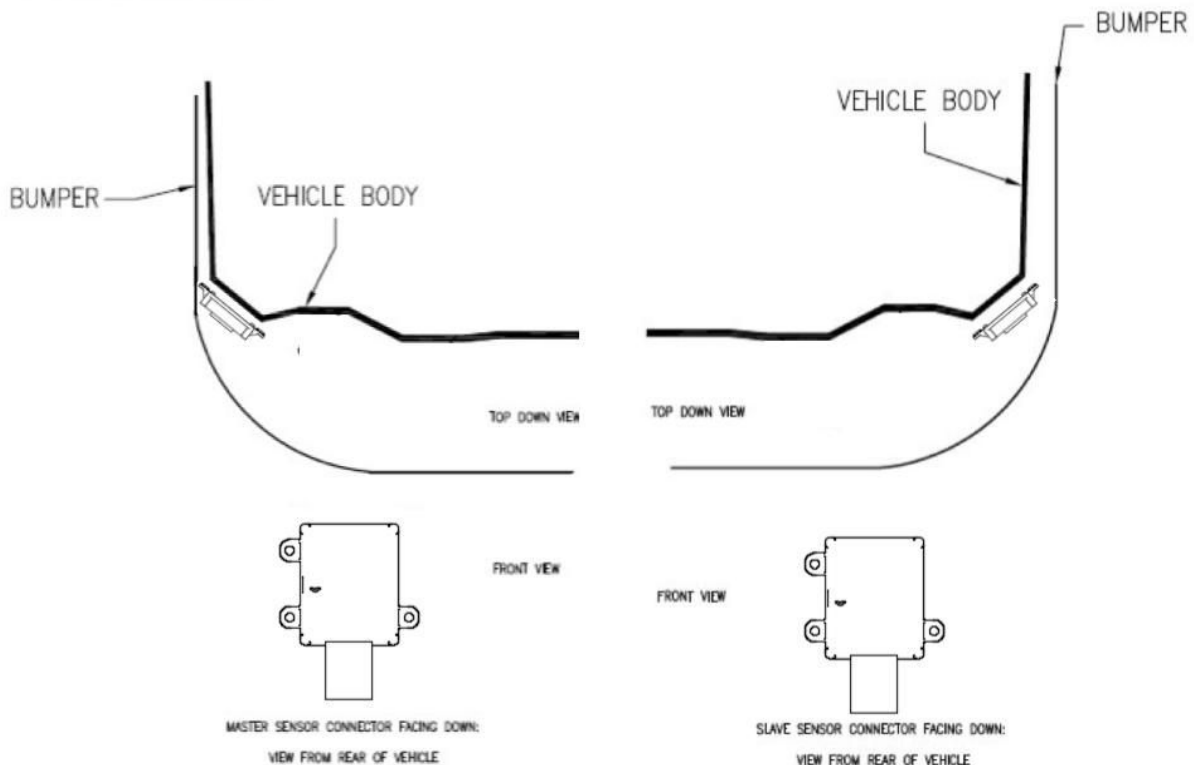

## INSTALLATION INSTRUCTIONS

4. For the interior harness installation:
  - a. GREEN wire connects to the vehicle's RIGHT TURN SIGNAL positive wire.
  - b. YELLOW wire connects to the vehicle's LEFT TURN SIGNAL positive wire.
  - c. WHITE wire connects to the vehicle's REVERSE lights.
  - d. BROWN wire connects to the vehicle's PARKING LIGHTS positive wire.
  - e. RED wire connects to vehicle IGNITION.
  - f. BLACK plastic-coated wire connects to a good, clean GROUND in the vehicle.
5. Pinouts for the ECU connector:

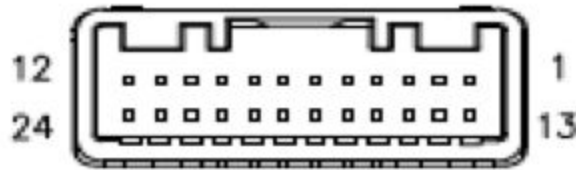

PIN	FUNCTION	DESCRIPTION
1	NC	SPEAKER OUTM
2	NC	SPEAKER OUTP
3	SWITCHED VBAT	BUZZER V+
4	SWITCHED VBAT	HMI V+
5	SWITCHED VBAT	SENSOR V+
6	CAN RADAR HIGH 0	SENSOR CANH
7	CAN RADAR LOW 0	SENSOR CANL
8	NC	—
9	NC	—
10	NC	—
11	CAN VEHICLE HIGH	VEHICLE CANH
12	CAN VEHICLE LOW	VEHICLE CANL
13	NC	—
14	NC	—
15	LOW SIDE DRVE	L. LED—
16	LOW SIDE DRVE	R. LED—
17	LOW SIDE DRVE	BUZZER—
18	INPUT	REVERSE
19	NC	—
20	INPUT	VEH L.IND
21	INPUT	VEH R.IND
22	INPUT	ILL
23	GND	GND
24	V+	ECU+

# INSTALLATION INSTRUCTIONS

## INSTALL HMI (warning lights) and BUZZER:

1. Plug in HMI (human-machine interface) harness to interior harness. The short wire with connector goes to the driver's side and the longer wire goes to the passenger side.
2. Remove both driver and passenger A-pillar covers from vehicle.
3. Find a visible location low on the A-pillars covers to mount HMI.
4. Mark the location on both A-pillar covers and using a 9/16-inch drill bit, carefully drill through each A-pillar.
5. Insert HMI into drilled hole and secure from the back side of A-pillar cover using retaining washer.
6. Plug in HMI to HMI harness and reattach A-pillar covers to appropriate sides, taking care not to pinch HMI harness wires.
7. Plug the buzzer into the interior harness. Find a flat surface to mount the buzzer to and remove backing of double-sided tape to attach to preferred location. (The more hidden the location is, the lower the buzzer volume will be.)

## INSTALL ECU INTO VEHICLE:

1. Plug the interior harness into the ECU.
2. Determine best mounting position for ECU.
3. Mount the ECU.
4. Attach the BLUE CAN HI wire from the ECU to pin location 6 on the vehicle's OBDII connector.
5. Attach the BROWN CAN LOW wire from the ECU to pin location 14 on the vehicle's OBDII connector

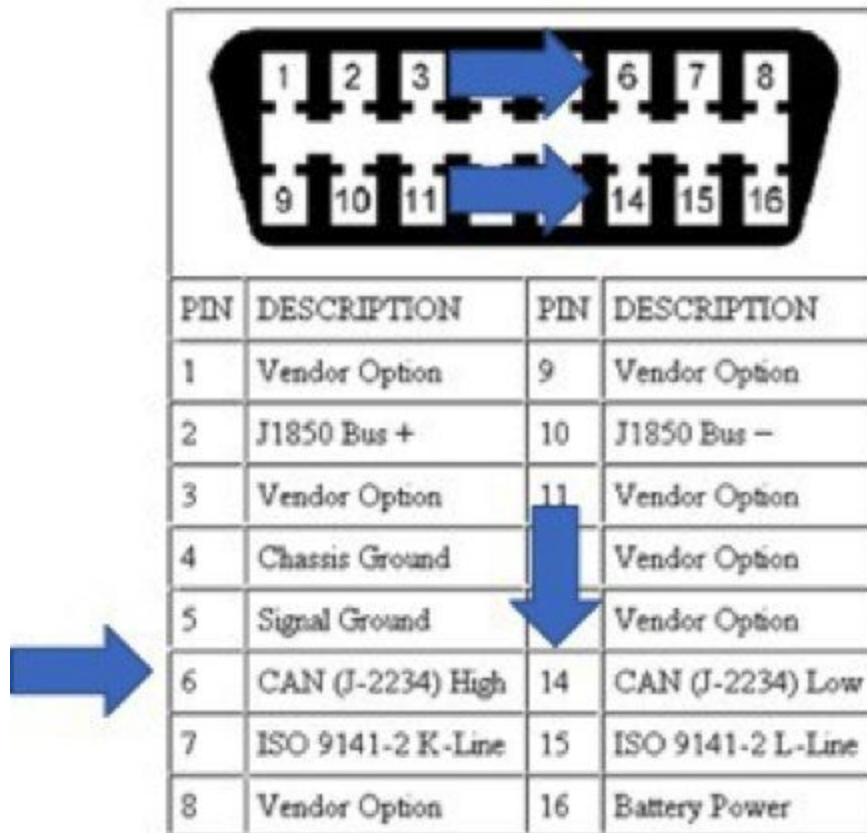

OBD-II Connector and Pinout

## INSTALLATION INSTRUCTIONS

### PREPARING BRACKET

Radar module mounted on studs:

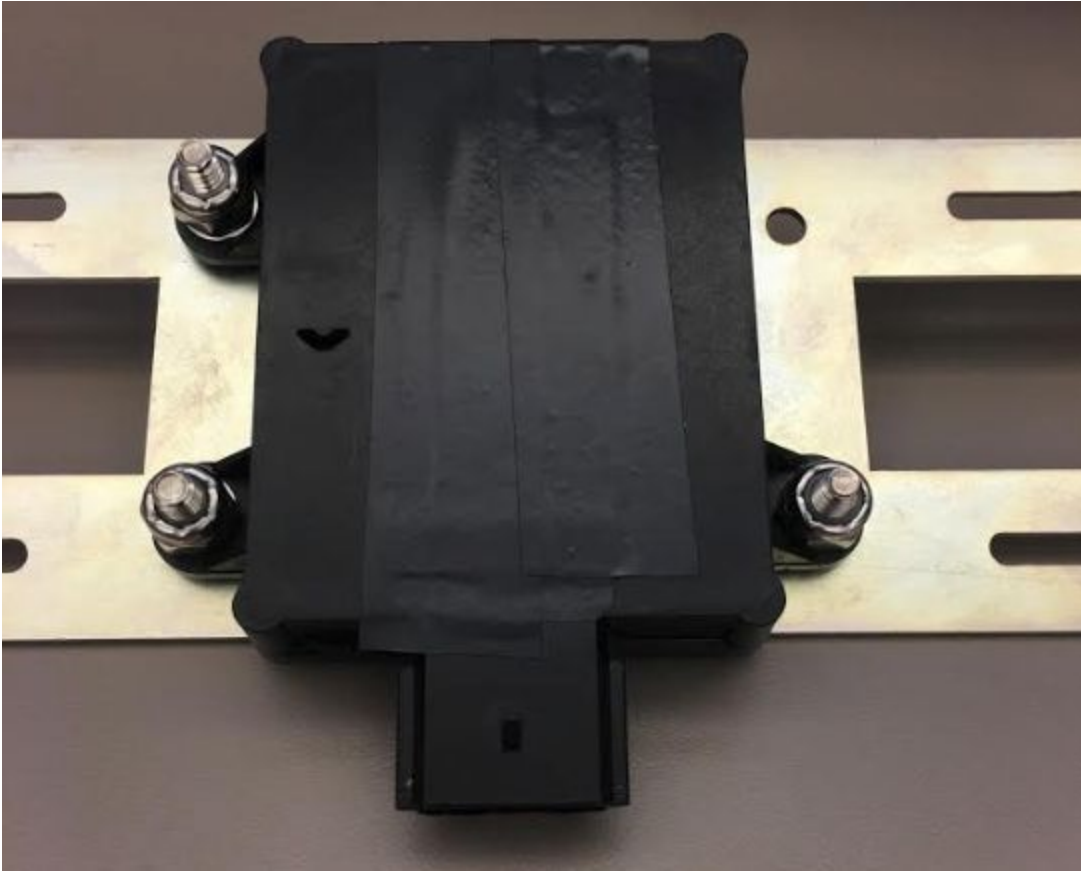

Use a washer in between the nut and the radar and in between the screw head and the bracket



## INSTALLATION INSTRUCTIONS

Using protractor to measure mounting angles:



### BRACKET MOUNTING EXAMPLES:



## INSTALLATION INSTRUCTIONS



## INSTALLATION INSTRUCTIONS



### HMI MOUNTING EXAMPLE:





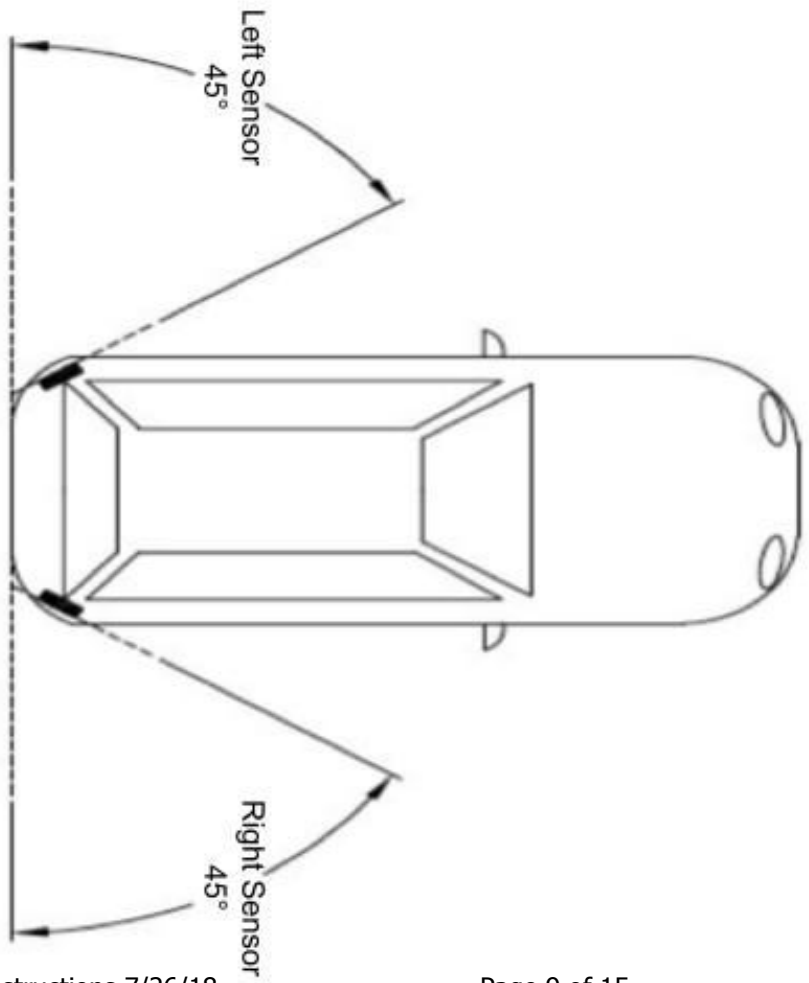
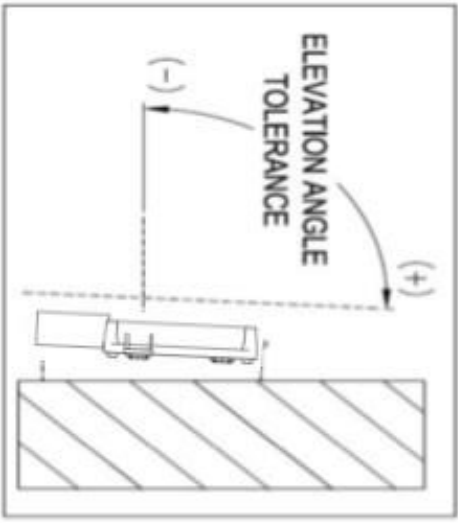
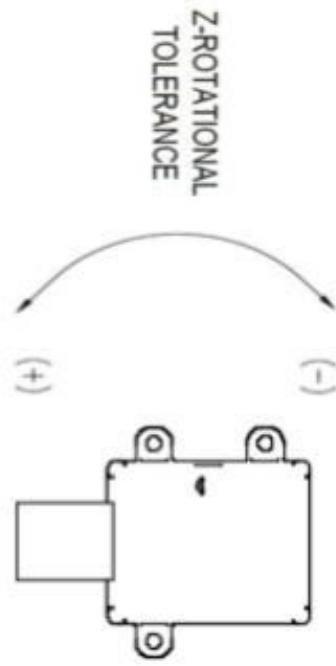

# INSTALLATION INSTRUCTIONS

BSD Sensor Position Parameters	Ideal Value	Tolerance	
		(-)	(+)
Z Rotational (in degrees)	0	-3	+3
Azimuth Angle (in degrees)	45	-2.5	+2.5
Elevation Angle (in degrees)	1	+1	+2.5

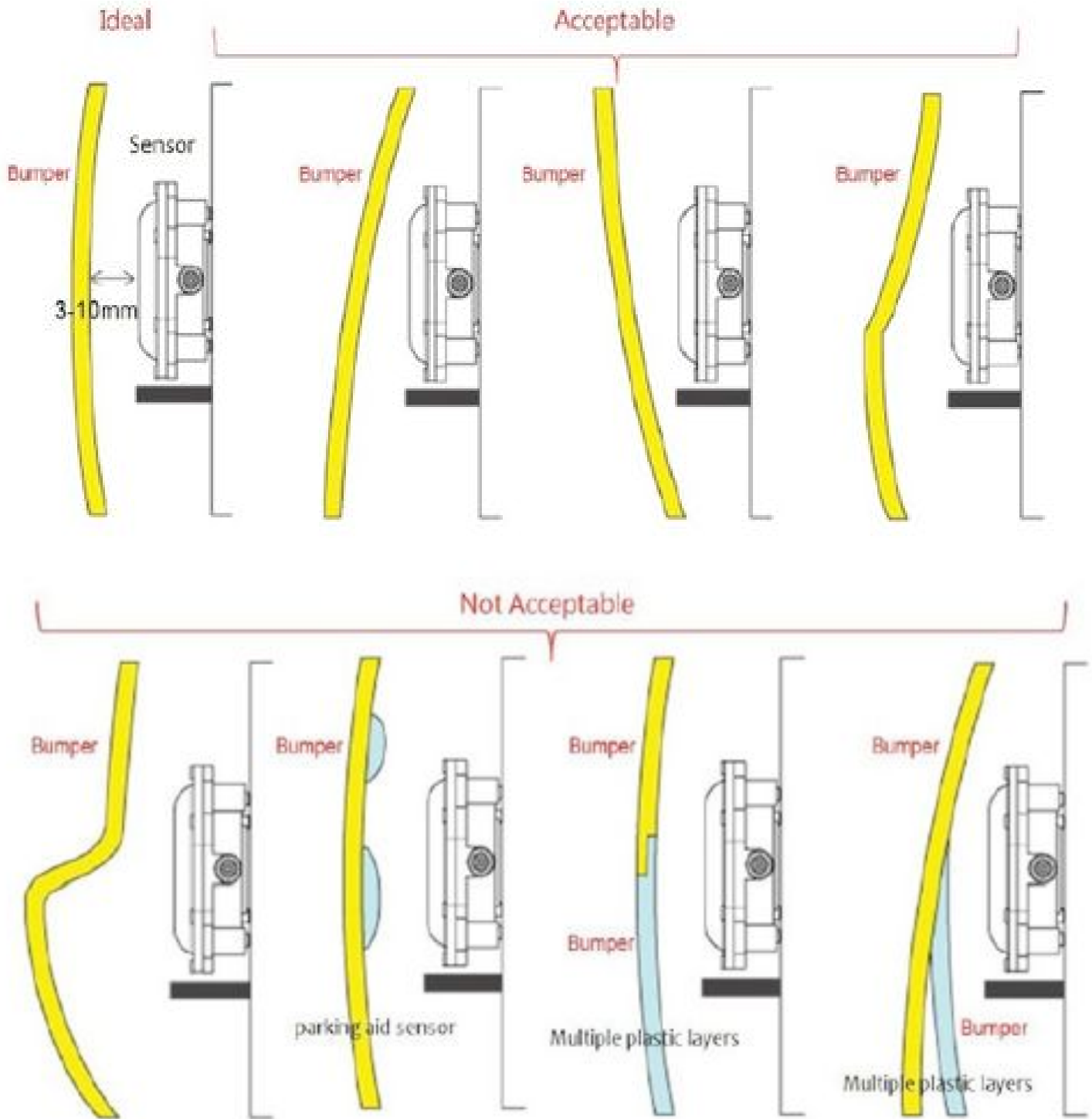

# INSTALLATION INSTRUCTIONS



**Important**  Ensure there are no obstructions or unfavorable surfaces on the bumper adjacent to where the sensors will be mounted.

# INSTALLATION INSTRUCTIONS

## Harness Schematic

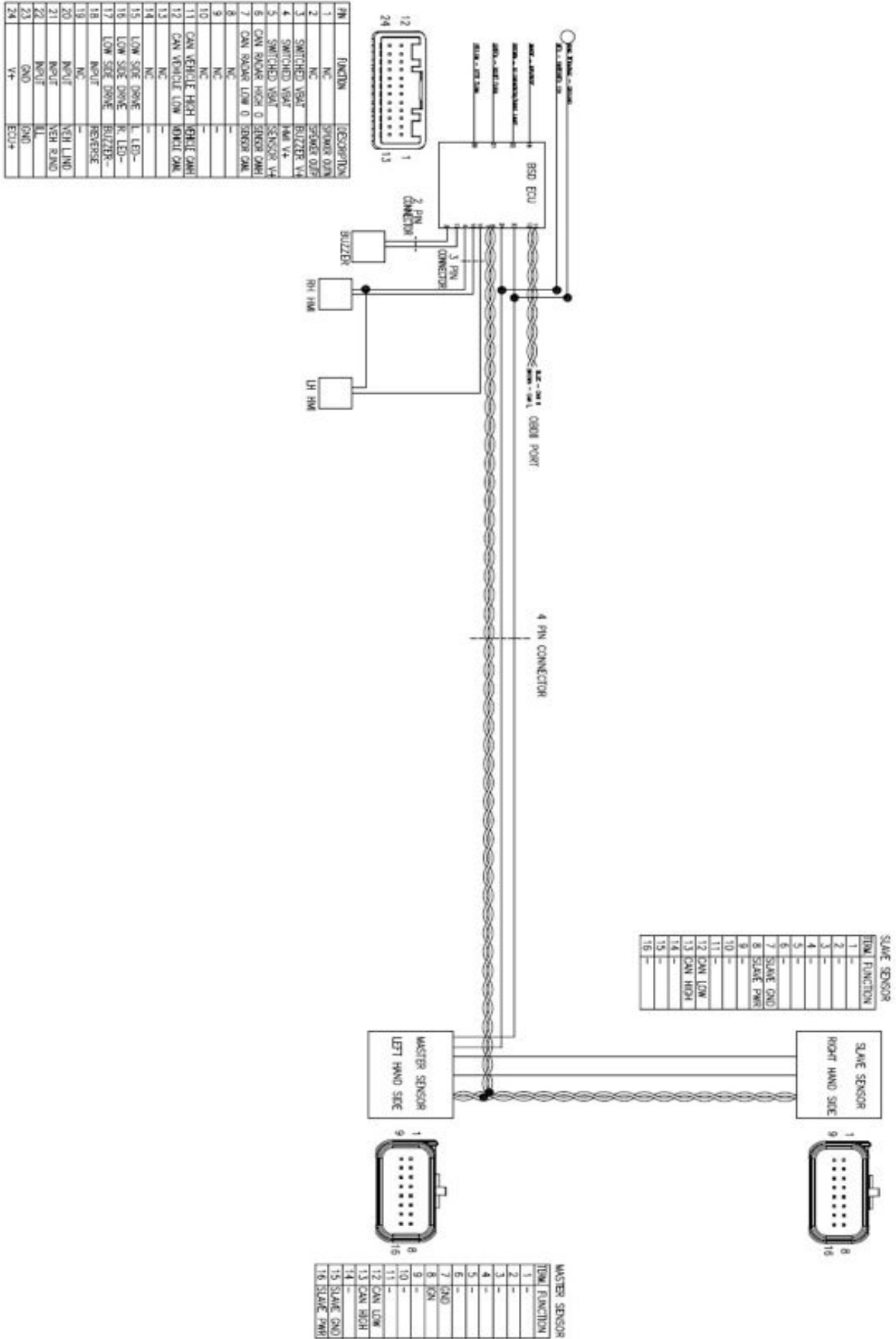

Pin	Function	Description
1	NC	SPARK OFF
2	NC	SPARK OFF
3	SWITCHED VBAT	BULBZER V+
4	SWITCHED VBAT	HMI V+
5	SWITCHED VBAT	SENSOR V+
6	CAN SIGNAL HIGH	SENSOR CAN
7	CAN SIGNAL LOW	SENSOR CAN
8	NC	-
9	NC	-
10	NC	-
11	CAN VEHICLE HIGH	VEHICLE CAN
12	CAN VEHICLE LOW	VEHICLE CAN
13	NC	-
14	NC	-
15	LOW SIDE DRIVE	L LED-
16	LOW SIDE DRIVE	RK LED-
17	LOW SIDE DRIVE	BULBZER-
18	INPUT	REVERSE
19	NC	-
20	INPUT	NEH LIND
21	INPUT	NEH RIND
22	INPUT	BL
23	GND	GND
24	V+	ECU+

# INSTALLATION INSTRUCTIONS

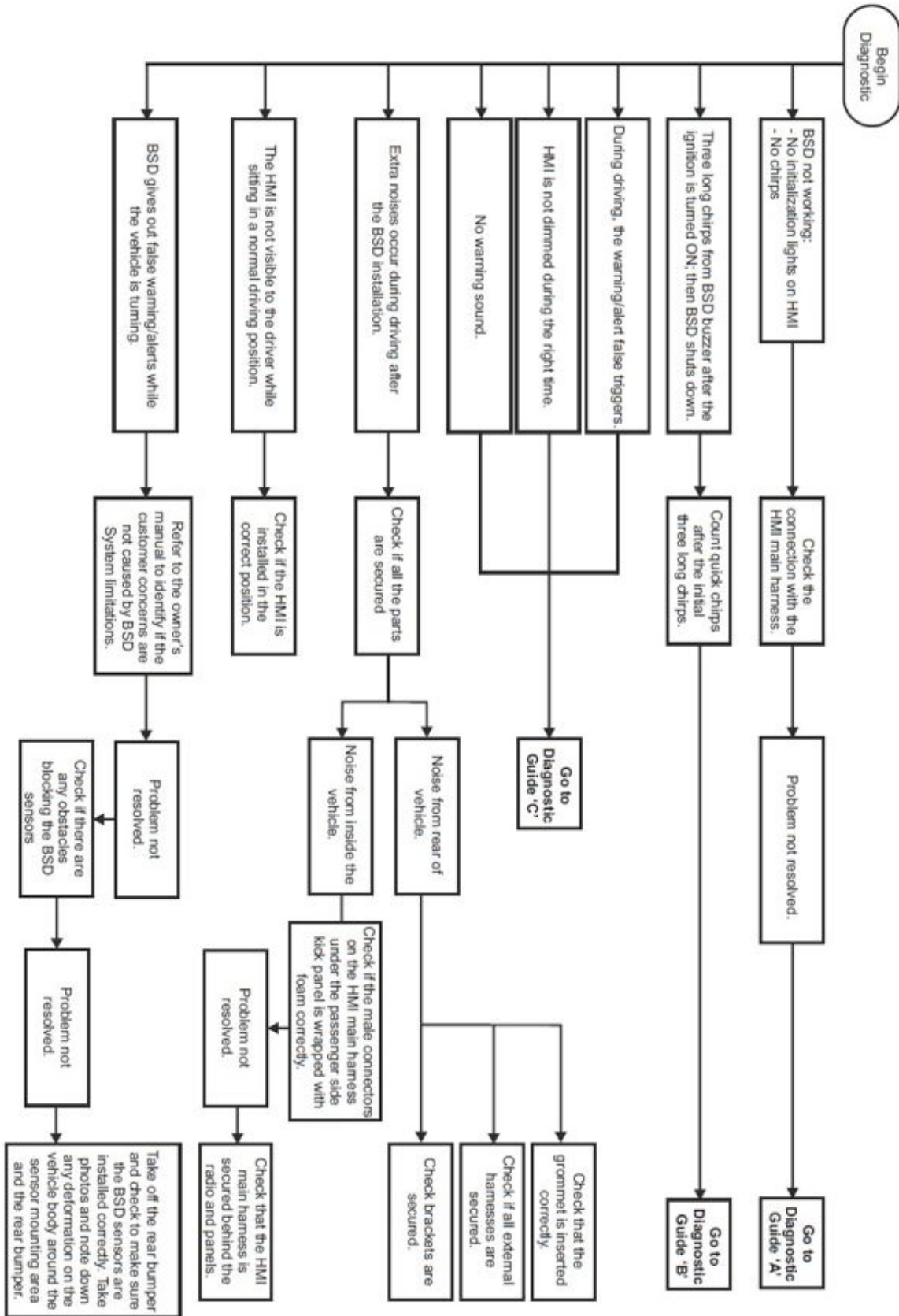

# INSTALLATION INSTRUCTIONS

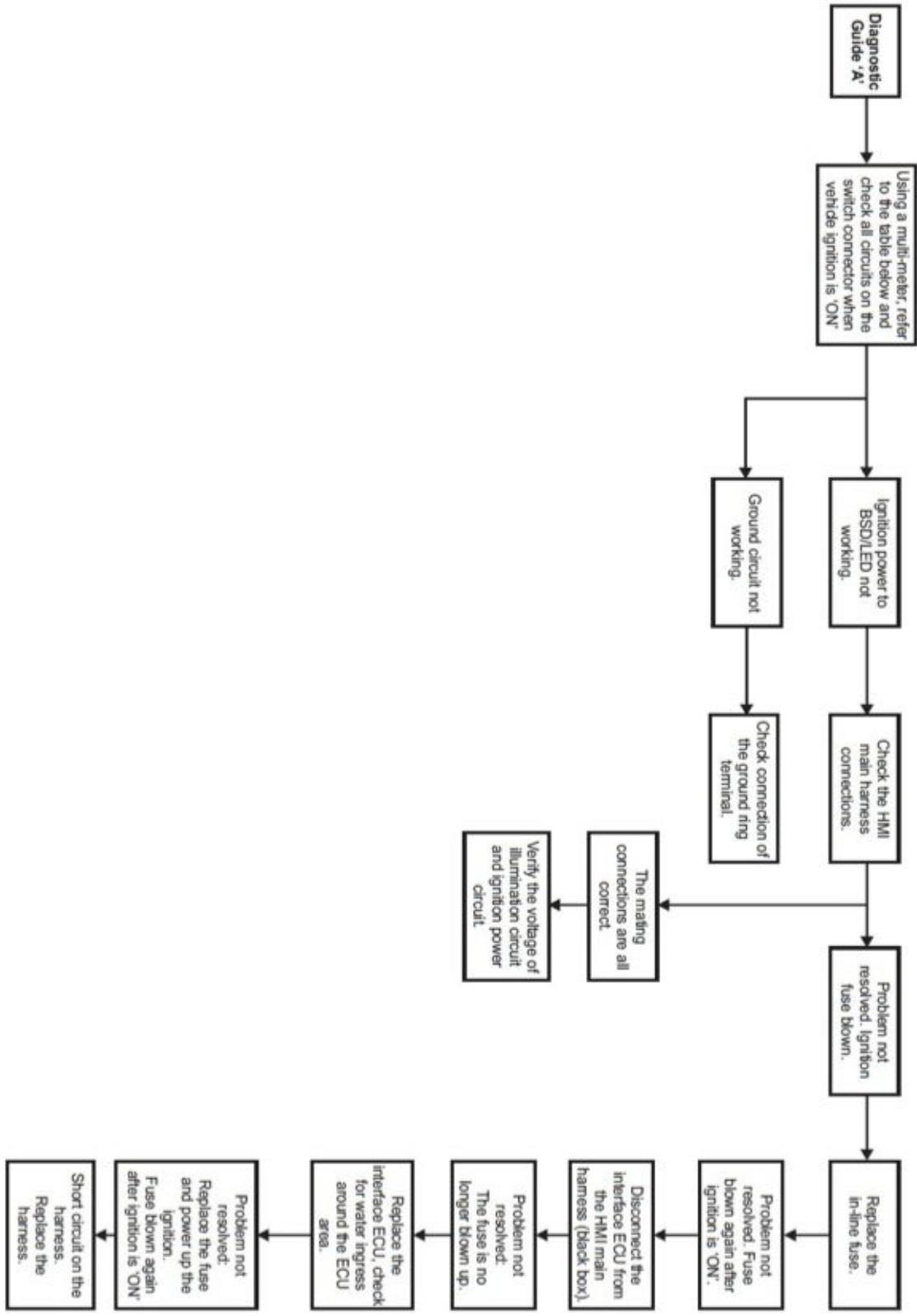

# INSTALLATION INSTRUCTIONS

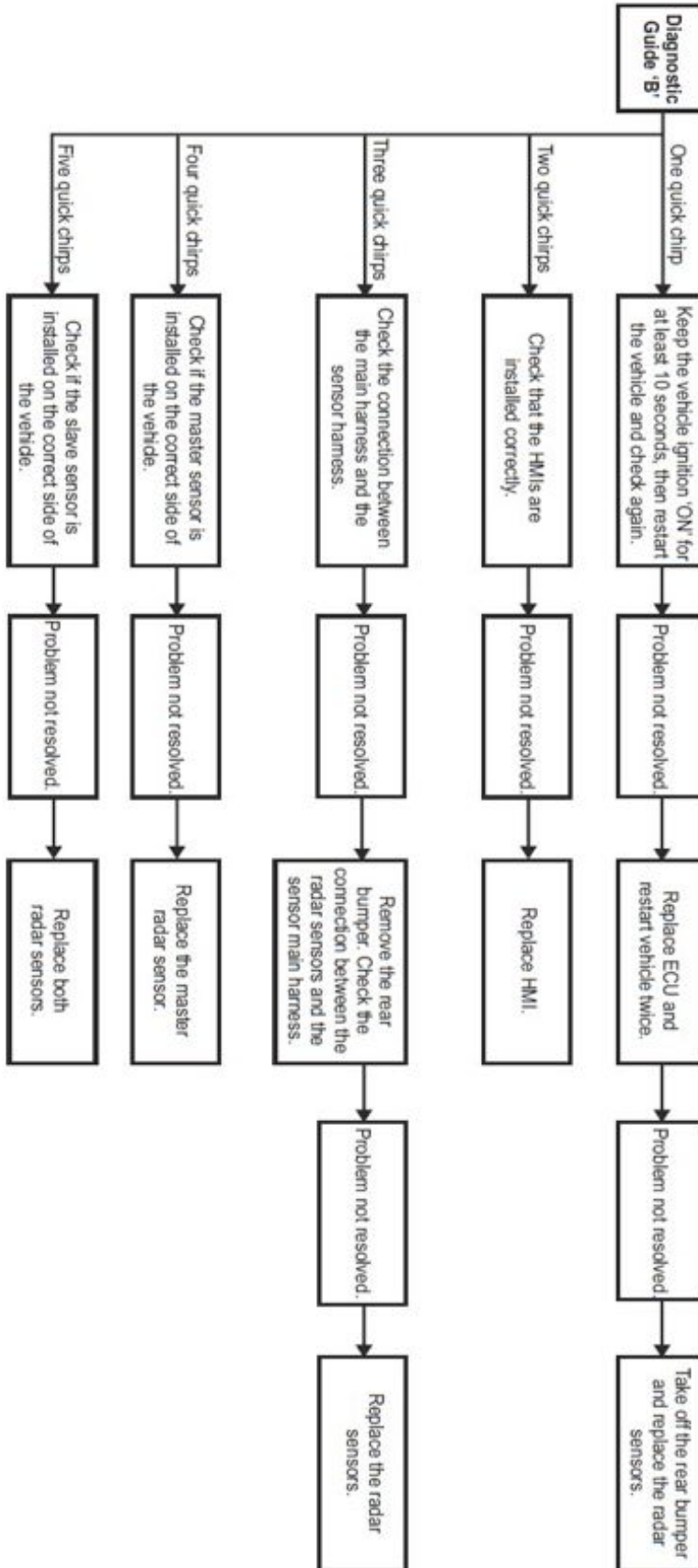

# INSTALLATION INSTRUCTIONS

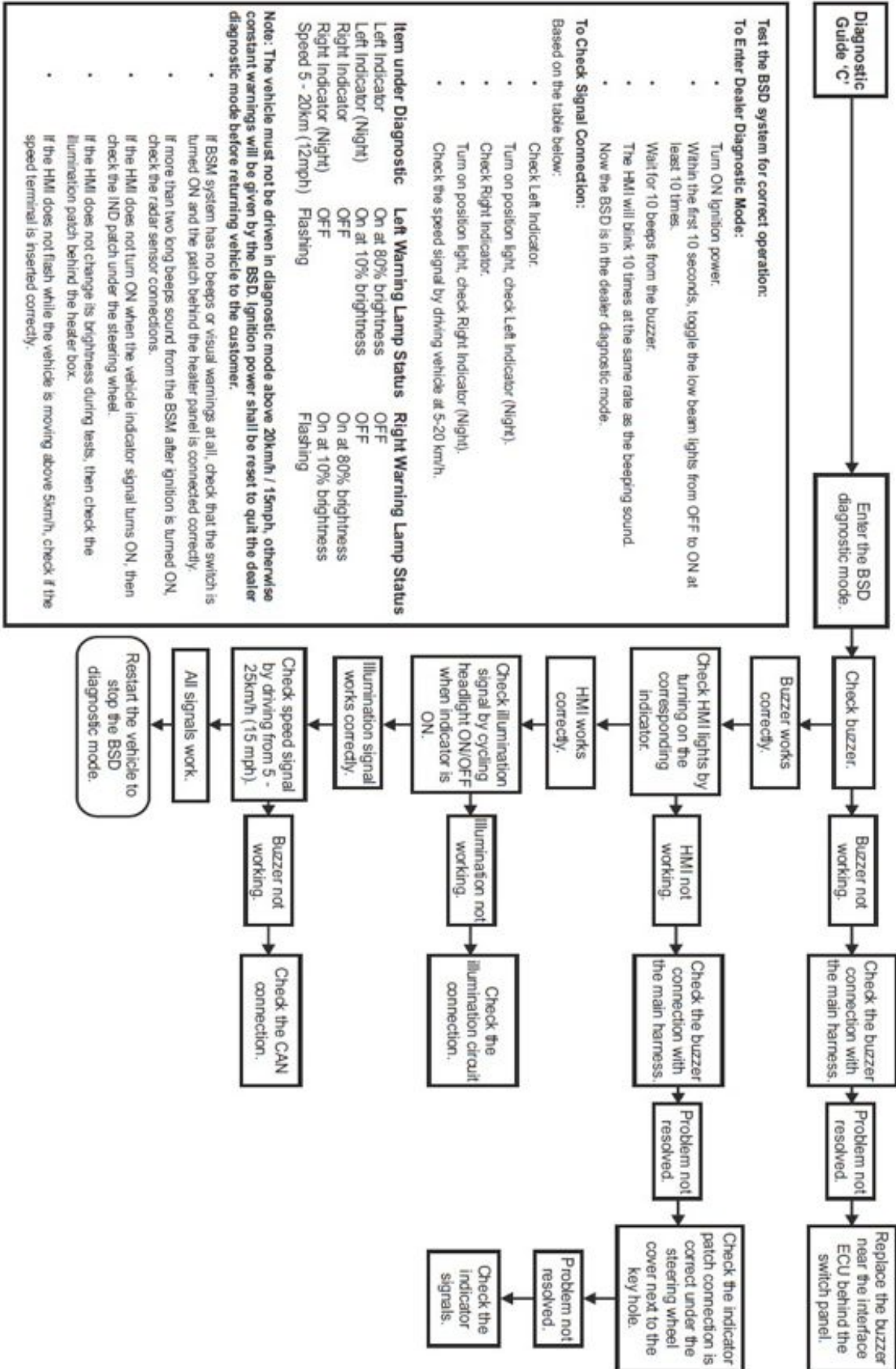

**To Enter Dealer Diagnostic Mode:**

- Turn ON ignition power.
- Within the first 10 seconds, toggle the low beam lights from OFF to ON at least 10 times.
- Wait for 10 beeps from the buzzer.
- The HMI will blink 10 times at the same rate as the beeping sound.
- Now the BSD is in the dealer diagnostic mode.

**To Check Signal Connection:**

Based on the table below:

- Check Left Indicator.
- Turn on position light, check Left Indicator (Night).
- Check Right Indicator.
- Turn on position light, check Right Indicator (Night).
- Check the speed signal by driving vehicle at 5-20 km/h.

Item under Diagnostic	Left Warning Lamp Status	Right Warning Lamp Status
Left Indicator	On at 80% brightness	OFF
Left Indicator (Night)	On at 10% brightness	OFF
Right Indicator	OFF	On at 80% brightness
Right Indicator (Night)	OFF	On at 10% brightness
Speed 5 - 20km (12mph)	Flashing	Flashing

**Note:** The vehicle must not be driven in diagnostic mode above 20km/h / 15mph, otherwise constant warnings will be given by the BSD. Ignition power shall be reset to quit the dealer diagnostic mode before returning vehicle to the customer.

- If BSM system has no beeps or visual warnings at all, check that the switch is turned ON and the patch behind the heater panel is connected correctly.
- If more than two long beeps sound from the BSM after ignition is turned ON, check the radar sensor connections.
- If the HMI does not turn ON when the vehicle indicator signal turns ON, then check the IND patch under the steering wheel.
- If the HMI does not change its brightness during tests, then check the illumination patch behind the header box.
- If the HMI does not flash while the vehicle is moving above 5km/h, check if the speed terminal is inserted correctly.