



**97-06 JEEP TJ REPL BODY BUSHING / 1" BODY LIFT KIT**

**Congratulations on your purchase of a new Rough Country 1" Body Bushing / Body Lift Combo. We are committed to providing you with the best product available for the best value. Your satisfaction is our highest priority!**

Rough Country recommends a certified technician installs this system. In addition to these instructions, professional knowledge of disassemble/reassembly procedures as well as post installation checks must be known. Check the kit hardware against the parts list. Be sure you have all the needed parts and understand where they go. Also please review the tools needed list and make sure you have needed tools.

**PRODUCT USE INFORMATION**

As a general rule, the taller a vehicle is the easier it will roll. We strongly recommend, because of rollover possibility, that the vehicle be equipped with a functional roll-bar and cage system. Seat belts and shoulder harnesses should be worn at all times. Avoid situations where a side rollover may occur.

Do not add, alter, or fabricate any factory or after-market parts which increase vehicle height over the intended height of the Rough Country product purchased. We will not be responsible for any product that is altered.

This 1" combination body lift / replacement body bushing kit can be used with Rough Country's lift kit if desired to allow the fitment of larger tires for off road use.

**NOTICE TO DEALER AND VEHICLE OWNER**

Any vehicle equipped with any Rough Country product must have the "Warning to Driver" decal installed on the sun visor or dash. The decal is to act as a constant reminder for whoever is operating the vehicle of its unique handling

**BODY LIFT PRE INSTALLATION NOTES:**

To ensure the SRS system (Air bag system) is not accidentally deployed during installation, always ground yourself and the vehicle. Exercise extreme caution when working near SRS sensors and wiring. DO not allow anyone near air bags during the lift kit installation. Accidental deployment can result in serious injury or death. As a precaution, the negative and positive wire should be disconnected from the battery with the negative wire being removed first. Also the air bag fuse can be removed from the fuse panel behind the glove box. Check hoses and wiring before and recheck during installation taking caution to not overextend them.

**Kit Contents :**

- 6-Dr / Pass Side Body Bushings
- 4-Rear Body Bushings
- 1-Front Center Body Bushing
- 11-Body Bushing Sleeves
- 2-Fr Core Support Brackets
- 1-Shift Control Bracket
- 1-RC607Bag:

- 2-1/4" x 3/4" bolts
- 4-1/4" Washers
- 2-1/4" Nuts
- 6-1/2" Flat Washers
- 6-1/2" x 4 1/2" Bolts
- 5-7/16" Flat Washers
- 1-7/16" x 4" Bolts
- 4-7/16" x 3 1/2" Bolts
- 2-5/16" x 3/4" Self Tapping Bolts



**Torque Specs:**

Size	Grade 5	Grade 8
7/16"	45 ft/lbs	60 ft/lbs
1/2"	65 ft/lbs	90 ft/lbs
1/4"	12 ft/lbs	18 ft/lbs

**Tools Needed:**

Floor jacks, Wood Blocks, Wheel chocks, Torque wrench, 1/2 drive ratchet 5/8" socket/wrench, 3/4" socket /wrench, Safety glasses, Thread locker



Location 1

Please see diagram below for proper body lift bushing placement.

DIAGRAM 1

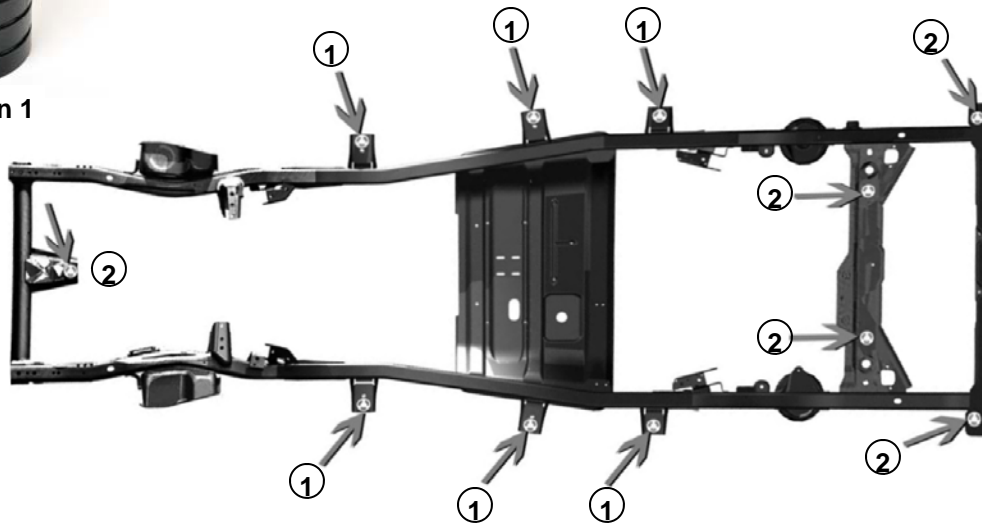

Location 2

### INSTALLATION INSTRUCTIONS

1. Make sure the vehicle is on a level smooth surface.
2. Loosen the 11 body bolts using a 5/8" socket. Do not remove the stock bolts at this time.
3. Remove the front body mount bolt as shown in **Photo 1**. Remove either the 5 passenger side bolts or the 5 driver side bolts. Do not remove both sides. Installation is performed one side at a time.
4. Using a floor jack slowly jack up the body of the Jeep and remove the factory body bushings on one side.
5. Remove the steel cup / sleeve from the stock body bushings. **See Photo 2.** The steel cup/ sleeve will be reused.



Photo 1



Photo 2

6. Reinstall the steel cup / sleeve from the stock body bushing in the new body bushing. **See Photo 3.**
7. Install the supplied crush sleeve in the new body bushings with the smaller inner diameter hole. **See Photo 4.**



8. Install the bushings in the 3 side body locations marked **1** in the **Diagram 1**.
9. Remove the stock 2 rear most body bushings and center front body bushing marked **2** in **Diagram 1**.
10. Insert the supplied large diameter body bushings in the 2 rear most mounts and center front mount.
11. Repeat for opposite side.
12. Apply thread locker to the supplied 1/2" x 4 1/2" bolts and install the lower bushing / crush sleeve and washer on the 3 side body mounts. **See Photo 5.** Do not fully tighten at this time.
13. Install the lower bushing / crush sleeve and washer in the 4 rear mounts. Apply thread locker to the supplied 7/16" x 4" bolts and install. Do not tighten at this time.
14. Apply thread locker and install the 7/16" x 3 1/2" bolts, washer and crush sleeve in the front center mount. **See Photo 6.** Do not tighten at this time.



15. Place the new radiator core support bracket in place as shown and mark hole to be drilled. **See Photo 7.**
16. Drill the hole using a 9/32" drill bit. **See Photo 8.**
17. Secure using the bracket to the frame with the supplied 5/16" x 1" self tapping bolt. Tighten using a 1/2" wrench.

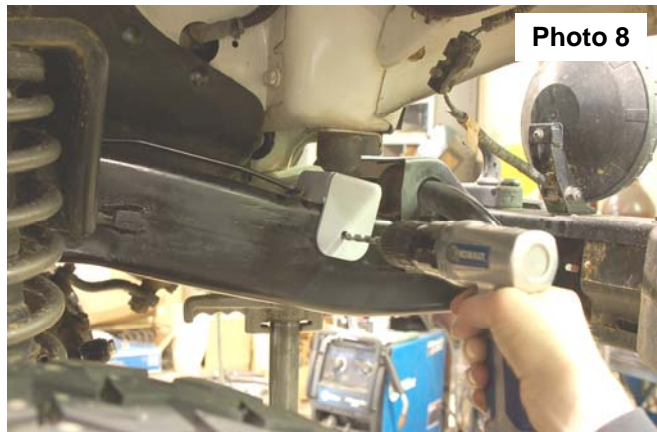
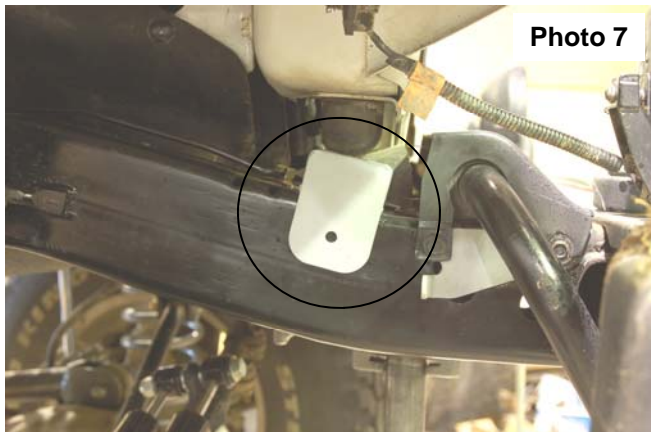

18. Tighten all body bolts to 30-35 ft/lbs. Do not over tighten. Over tightening the body mount bolts could crush the factory body mounts.
19. Remove the fan from the motor as shown in **Photo 9** using a 1/2" wrench. Save the hardware for reuse.
20. Remove the power steering reservoir from the fan shroud to allow it to be removed
21. Remove the fan shroud using a 7/16" wrench. **See Photo 10.** Save the factory hardware for reuse.

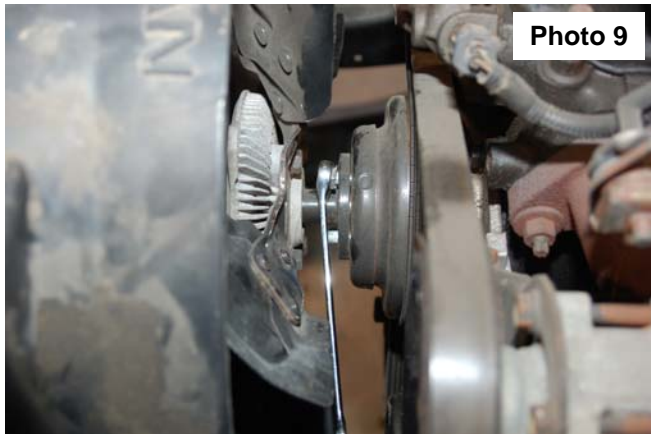

Photo 9



Photo 10

22. Measure 1" up as shown in **Photo 11** and **drill the shroud using a 1/4" bit.** *The lower passenger side hole will line up with an existing factory hole and will not require marking with a center punch. On 6 cylinder models, it may be necessary to remove a small portion of the fan shroud webbing to allow the 1/4" hole to be drilled.*
23. Test fit the fan shroud to the radiator by aligning with the new mounting holes and mark the location where the lower radiator hose interferes with the fan shroud. **See Photo 12.** Trim the fan shroud until it completely clears the radiator hose when mounted to the radiator. Reinstall the fan with factory hardware using a 1/2" wrench and check for interference between the fan shroud and fan blades, or any other objects, and trim the fan shroud accordingly.
24. Secure the shroud to the factory location with factory hardware using a 7/16" wrench. Tighten all hardware.



Photo 11



Photo 12

## TRANSFER CASE SHIFTER BRACKET INSTALLATION INSTRUCTIONS

These next steps will be necessary if the vehicle is equipped with a transfer case drop kit. If the vehicle does NOT have a transfer case kit installed the bracket should NOT be installed. The bracket is designed to adjust the 4WD shifter allowing the full range of the shift pattern. After drop bracket installation, check the operation of the 4WD shift lever to ensure the transfer case engages fully in all ranges. Additional "fine tuning" can be performed if the shifter does not fully engage in all the ranges. Refer to instructions below adjust the shift linkage. It may also be necessary to trim the body under the middle console to avoid interference with the shifter.

1. From underneath the vehicle, locate the shift control bracket. It is attached to the inside of the transmission tunnel on the driver side and acts as a pivot for the transfer case shift lever.
2. Remove the shifter linkage from the shifter plate that is mounted on the body tunnel as shown using a 10 mm wrench.
3. Reinstall the stock shifter bracket on the new drop bracket as shown with the 1/4" x 3/4" hardware. Tighten using a 7/16" wrench. **See Photo 1.**
4. Install the supplied drop bracket on the stock tunnel bracket with the supplied 1/4" x 3/4" bolts/washers & nuts. Tighten hardware using a 7/16" wrench. Check clearance on bolts. **See Photo 1.**

Due to factory variations on the shifter rod bracket, it may be necessary to modify the shifter bracket by slightly bending the mount on the rod to clear the shifter bracket or shifter bracket bolts. After noting how much to bend the bracket to clear, remove the shifter assembly and bend the bracket as shown to slightly clear the bracket / bolts. Do not over-bend!! See Photo 2.

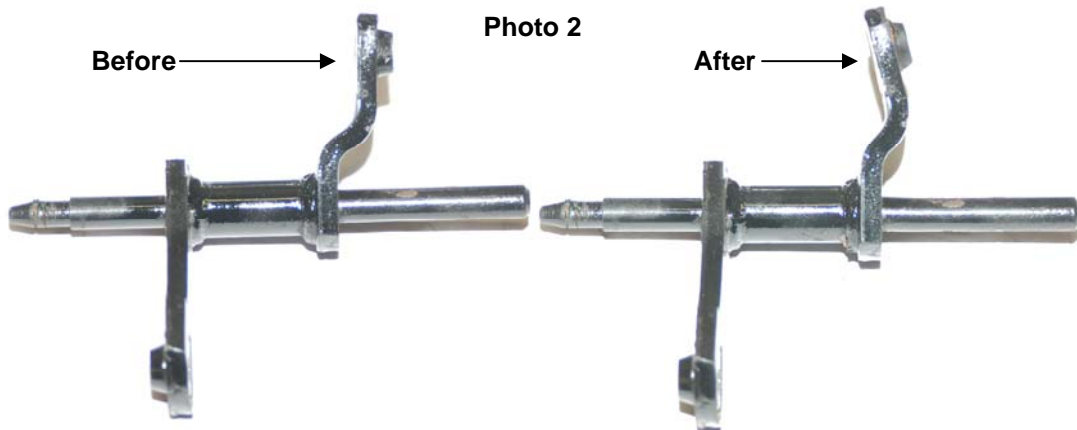
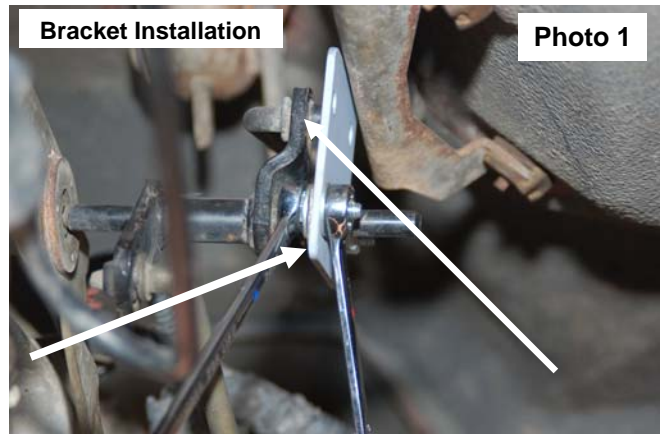

## SHIFTER LINKAGE ADJUSTMENT INSTRUCTIONS

If the 4WD shifter engages in all ranges, the following procedure will NOT be necessary.

1. Check the transfer case shifter to see if it will move to 4L. If not, the linkage will need adjusting. Place the shifter in 4L, loosen adjustment bolt and push the linkage forward until it stops. Now re-tighten adjustment bolt. **See Photo 1.** Check to be sure 4WD works properly.

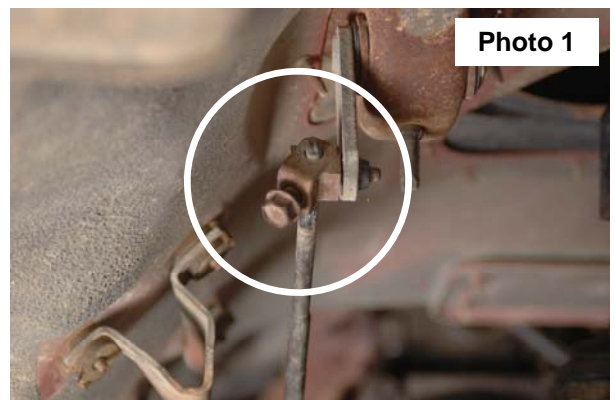

## MAINTENANCE INFORMATION

It is ultimately the buyers responsibility to have all bolts/nuts checked for tightness after the first 500 miles and then every 1000 miles or 3 months. Wheel alignment steering system, suspension and driveline systems must be inspected by a qualified professional mechanic at least every 3000 miles.