

921106110

# ROUGH COUNTRY

SUSPENSION SYSTEMS®



10611BAG

## JEEP 2018-19 JL Gas Tank Skid Plate

Thank you for choosing Rough Country for all your vehicle needs.

Please read instructions before beginning installation. Check the kit hardware against the kit contents shown below. Be sure you have all needed parts and know where they go.

If question exist, please call us @1-800-222-7023. We will be happy to answer any questions concerning this product.

Check all fasteners for proper torque. Check to ensure for adequate clearance between all components.

Periodically check all hardware for tightness.

### KIT CONTENTS:

Inside Middle Bracket x 1  
 Out Side Rear Bracket x 1  
 Out Side Front Bracket x 1  
 Gas Tank Skid Plate x 1

### TOOLS NEEDED:

15mm Socket  
 18mm Socket  
 9/16 Wrench and Socket

### HARDWARE INCLUDED:

3/8-16 x 1 Hex head bolt x 6  
 3/8 Flat washers x 7  
 3/8-16 Nylock Nut x 1



### Torque Specs:

Size	Grade 5	Grade 8	Size	Class 8.8	Class 10.9
5/16"	15 ft/lbs	20ft/lbs	6MM	5ft/lbs	9ft/lbs
3/8"	30 ft/lbs	35ft/lbs	8MM	18ft/lbs	23ft/lbs
7/16"	45 ft/lbs	60ft/lbs	10MM	32ft/lbs	45ft/lbs
1/2"	65 ft/lbs	90ft/lbs	12MM	55ft/lbs	75ft/lbs
9/16"	95 ft/lbs	130ft/lbs	14MM	85ft/lbs	120ft/lbs
5/8"	135ft/lbs	175ft/lbs	16MM	130ft/lbs	165ft/lbs
3/4"	185ft/lbs	280ft/lbs	18MM	170ft/lbs	240ft/lbs



## INSTALLATION INSTRUCTIONS

1. Remove the 2 out side gas tank bolts using a 18mm socket. Retain hardware for reuse. **See Photo 1.**
2. Install the gas tank skid plate mount on the bottom of the frame and gas tank mount. Using the 2 retained bolts and tighten using a 18mm socket. **See Photo 2.**

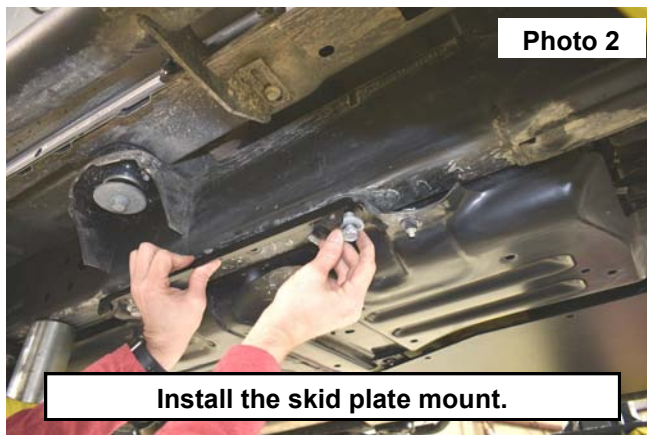
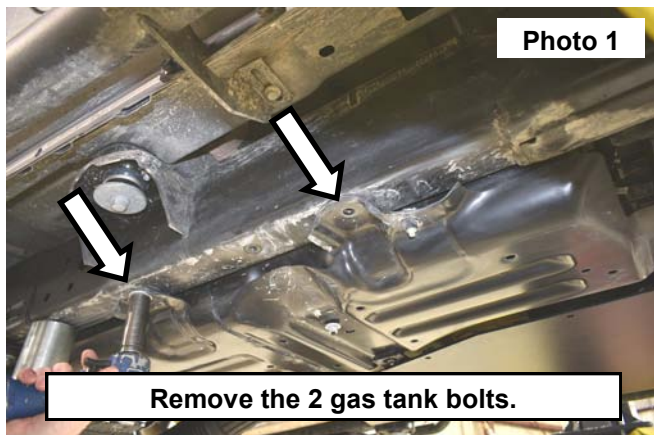

3. Remove the gas tank bolt from the inside of the crossmember. Use a 18mm socket and retain the hardware. **See Photo 3.**
4. Locate the bracket shown in **Photo 4.**

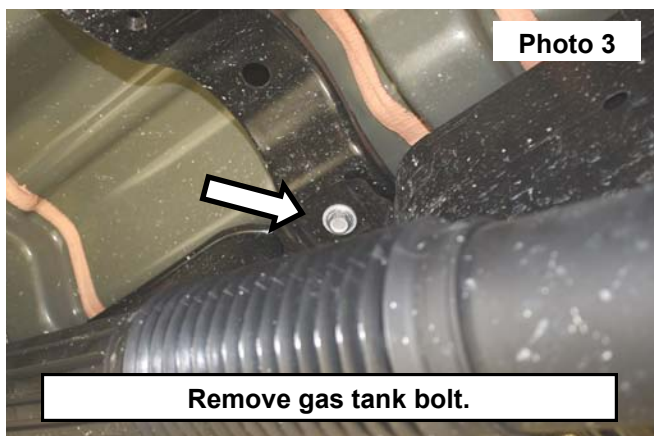

5. Install the bracket to lay flush with the inside of the gas tank. Snug the bolt so the bracket can be moved to align the skid plate. **See Photo 5.**
6. Remove the right rear gas tank bolt using an 18mm socket. **See Photo 6.**

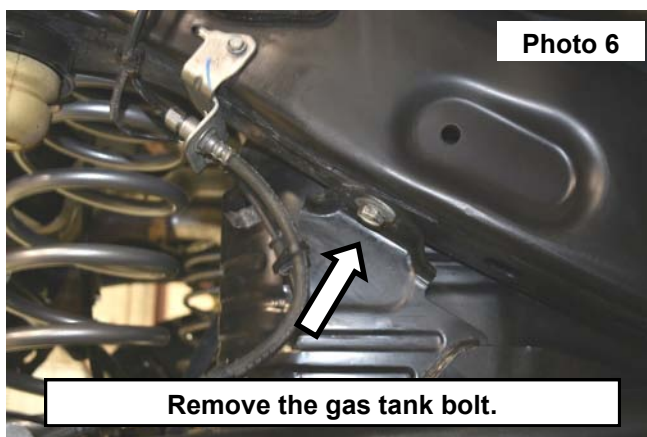
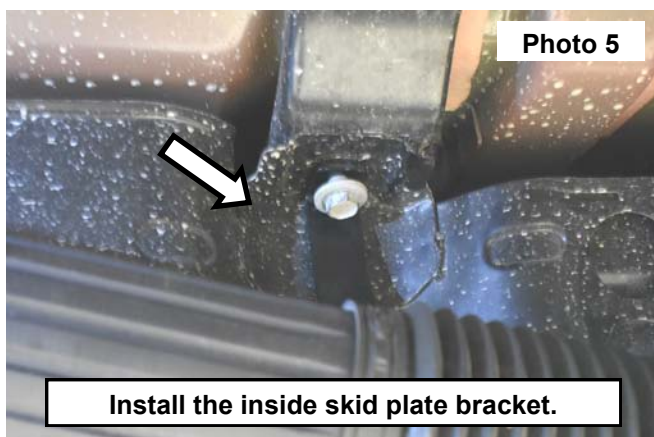

7. Locate the bracket shown in **Photo 7**.
8. Install the bracket onto the right rear location of the gas tank mount using the OE bolt. Snug the bolt to where the bracket can still move. **See Photo 8**.

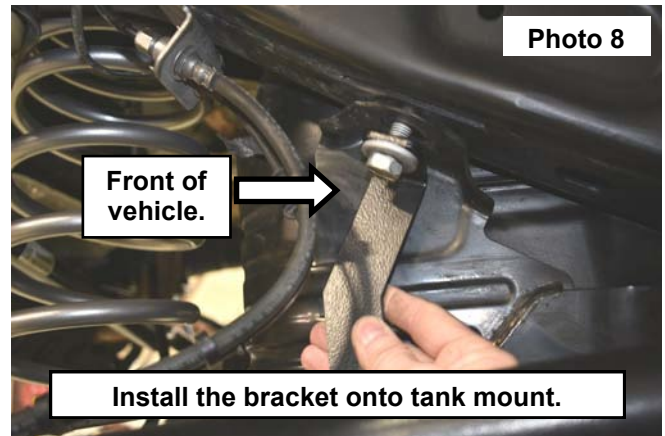
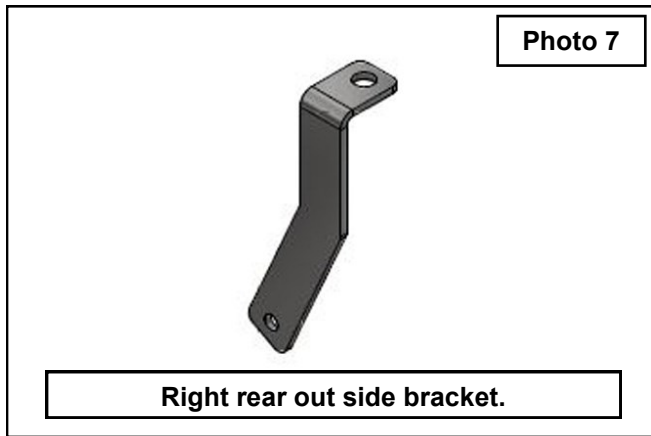

9. Remove the front gas tank mount bolt using a 18mm socket. Retain hardware for reuse. **See Photo 9**.
10. Install the gas tank skid plate. **See Photo 10**.

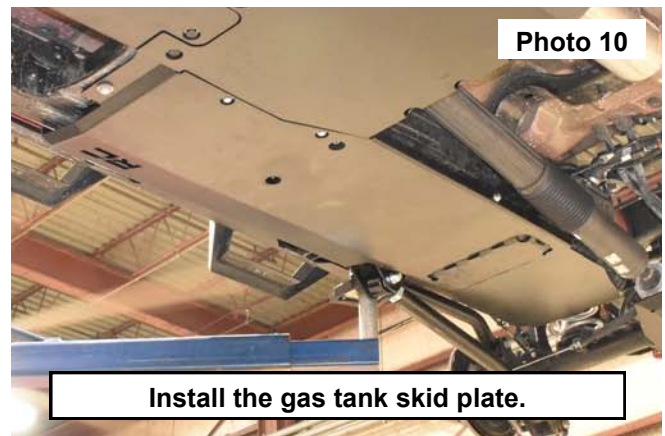
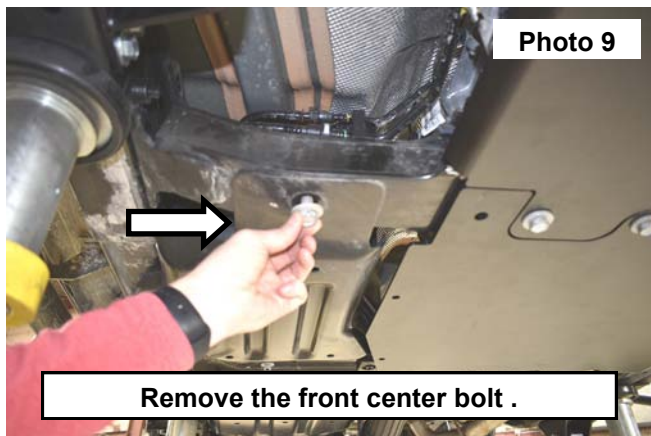

11. Install the (2) supplied 3/8-16 x 1" bolts 3/8 flat washers with the hex head on bottom into the gas tank skid plate and transfer case skid plates welded nuts. Hand tighten. **See Photo 11**.
12. Install the OE nut onto the stud through the gas tank skid plate. Hand tighten. **See Photo 12**.

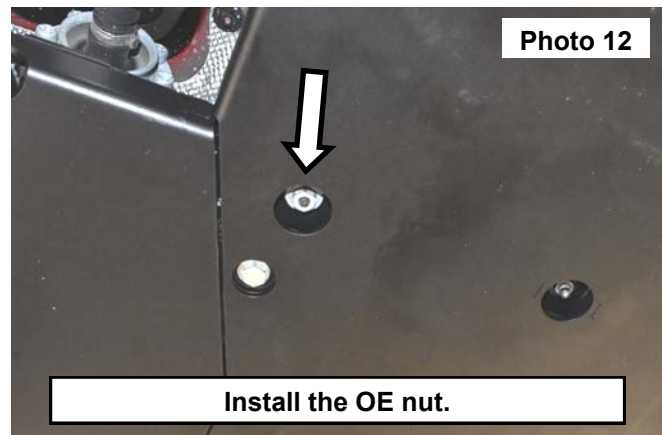
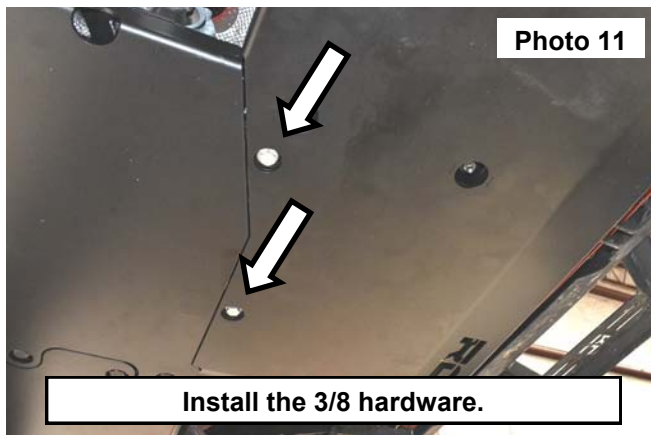

13. Install the 3/8-16 x 1 hex head bolt and 3/8 flat washer from the inside out on the right rear bracket, installing the 3/8 flat washer and 3/8-16 nylock nut onto the bolt. Hand tighten the 3/8 hardware . **See Photo 13.**
14. Install the 3/8-16 x 1 hex head bolt and 3/8 flat washer into the welded nut on the inside bracket. Hand tighten the 3/8 hardware . **See Photo 14.**

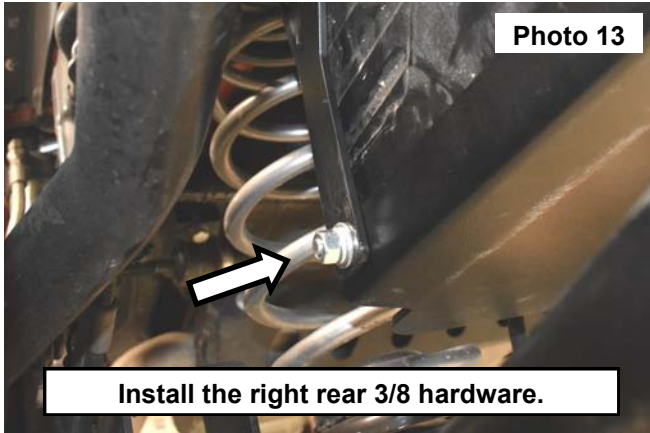

15. Install the OE bolt into the front center of the gas tank skid plate. Hand tighten. **See Photo 15.**
16. Install 2 of the supplied 3/8-16 x 1 hex head bolts and 2 of the 3/8 flat washers into the welded nuts on the side of the gas tank skid plate. **See Photo 16.**
17. At this time tighten all of the OE hardware installed into the brackets and skid plate mounts using a 18mm socket. Tighten all of the 3/8 hardware on the skid plate to the brackets using a 9/16 wrench and socket.
18. Tighten the installed nut on the gas tank stud using a 15mm socket.

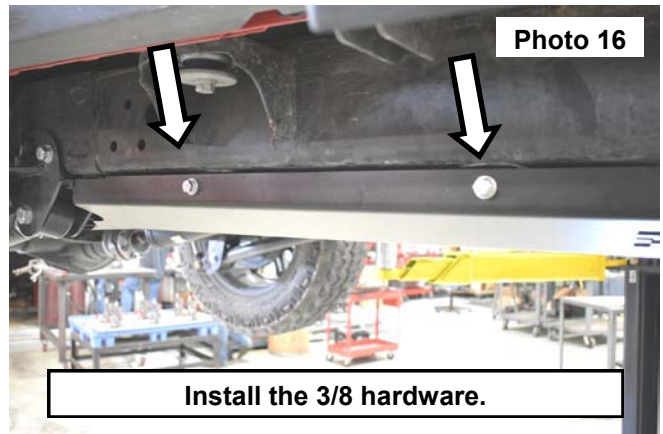
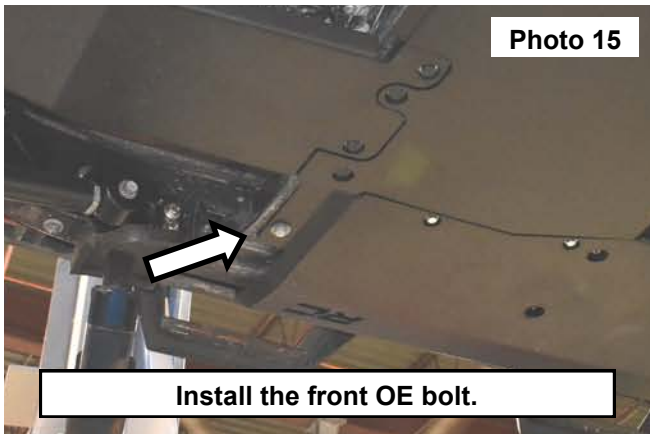

19. Check all of the installed hardware to be tight. **See Photo 17.**



By purchasing any item sold by Rough Country, LLC, the buyer expressly warrants that he/she is in compliance with all applicable, State, and Local laws and regulations regarding the purchase, ownership, and use of the item. It shall be the buyers responsibility to comply with all Federal, State and Local laws governing the sales of any items listed, illustrated or sold. The buyer expressly agrees to indemnify and hold harmless Rough Country, LLC for all claims resulting directly or indirectly from the purchase, ownership, or use of the items.

