











SummitView™ Jeep Wrangler (JK) Adjustable Rear Vision System

with OEM-Grade Camera For Factory Display

SUTV-8839



Recommended Tools				Difficulty Level
 Wrench	 Wire Strippers	 Wire Cutters	 Electrical Tape	
 Screw Driver	 Panel Removal Tool	 Zip Ties	 Socket Set	Install Time
Questions? Call the Brandmotion technical support line at (734) 619-1250 or CLICK HERE				 1hr 30m - 2hr

Kit Contents

Kit A

Components for installing the **SUTV-8839**



Kit Contents:

1x OEM-Grade Camera

1x Adjustable 5th Wheel Camera Mount

1x Video Chassis Harness

1x RCA to Factory 22 Pin connector

3x Push Nuts

15x Zipties

1x Dual Camera Interface

Access the Radio

Part 1

Preparing the Radio

1. First, you need to gain access to the back of your aftermarket radio. If you already have access, skip to part 2.
2. Start by removing the rubber bin insert from the top of the dash
3. Remove the 7mm bolt under the rubber bin insert.
4. Using a plastic trim removal tool, remove the window switch panel.
5. Disconnect harness from window switches.
6. Remove the 7mm bolt behind the window switch panel.
7. Remove driver knee bolster cover
8. Remove (2) 7mm bolts on both sides of the steering column.
9. Remove center stack/cluster trim
10. Remove the glove box for access. You will need access to the area behind the glove box to make your connection to the radio.
11. Remove (4) 7mm bolts to remove radio from dash



Install the Video Interface

Part 1

Module Configuration

Before Installing:

Disconnect negative battery terminal before beginning installation!

DIP Switches must be set before installation of interface module!

For vehicle specific instructions for dash disassembly, reference workshop manual.



Part 2

Power and Signal Connection

BACKUP CAMERA ADD-ON

+ Optional 2nd Camera - With out Factory Backup Camera

IMPORTANT NOTE: SET DIP SWITCHES BEFORE PROCEEDING

Programming & Connections

DISCONNECT	J1 (6-Pin) Jumper from ARC CHRY52R2 or ARC CHRY22 T-Harness. Set jumper aside.	WIRING CONNECTIONS MADE WITH VEHICLE IGNITION OFF
CONNECT	257357 Module to 6-Pin Connector	
CONNECT	12-PIN ARC-ACC357 Accessory Harness to 257357 Module	
CONNECT	"CAMERA IN " on T-Harness to " VIDEO OUT " on ARC-ACC357 "OEM CAM OUT " has NO CONNECTION	
CONNECT	Camera power to "ACC 12V+ OUTPUT" <i>Do not use Reverse output to power camera</i>	
CONNECT	Camera ground to "GROUND OUTPUT"	
CONNECT	(Optional) Switched +12V -or- Ground to " AUX CAM TRIGGER " for manual 2nd camera activation	
CONNECT	Aux Camera Video Output to " AUX CAM INPUT " (Optional)	
CONNECT	T-Harness in vehicle between factory radio and factory radio connector.	
VERIFY	All connections per diagram	

Programming Instructions

SWITCH	IGNITION TO ON/ACC (Do not Start Engine) For <i>Push-to-Start, Do not Press Brake</i>
WAIT	For radio to fully power on
SWITCH	IGNITION TO OFF REMOVE KEYS from ignition
WAIT	3 Minutes for vehicle to fully enter "Sleep" mode <i>*Close and lock all doors</i> <i>*Move proximity keys away from vehicle</i>

REPEAT This programming procedure once more
(Two total times)

VEHICLE MUST PERFORM TWO FULL POWER CYCLES FOR
SUCCESSFUL PROGRAMMING

Note: If only adding rear camera, output from the camera can be connected directly to "CAMERA IN" on the vehicle specific T-Harness.

Part 3

Power and Signal Connection

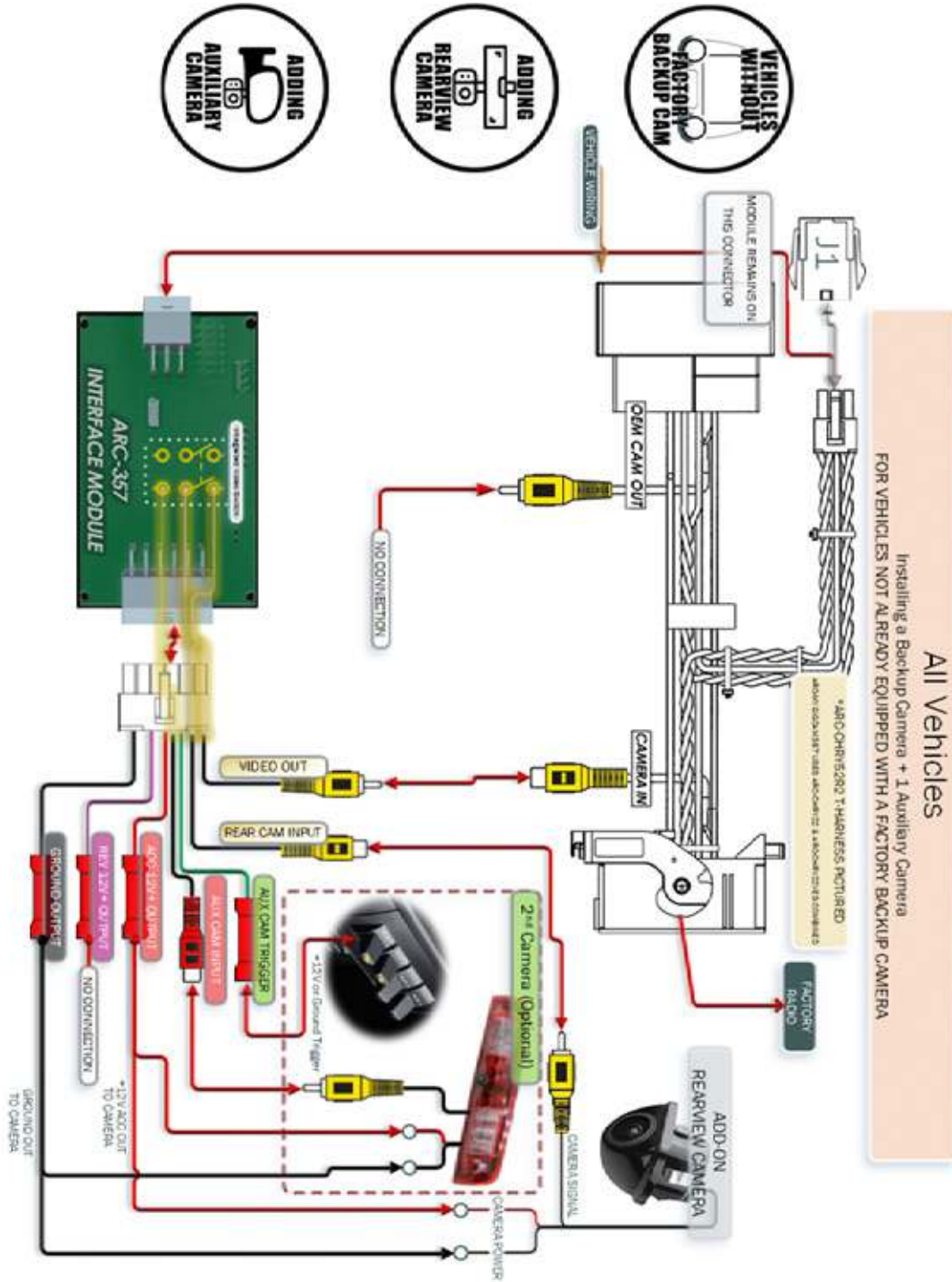

Part 4

Camera Operation

IMPORTANT NOTES

- If camera functionality is tested without camera(s) fully powered and connected, system may display a “Camera not Available” message and will temporarily disable camera input. Allowing the vehicle to sit for 5 minutes with ignition off will reset the function.
- **Display may stay in reverse camera mode until vehicle is driven to 7MPH.** This is a factory function and cannot be changed.
- Module must remain installed for proper operation.

Manual Activation

- The **green** manual activation wire can be connected to +12V or Ground to manually activate the secondary camera. This can also be adjusted to only recognize either using the ARC 357 PC Configuration Tool.
- Blind Spot mode will automatically activate the aux camera with the right blinker in compatible vehicles. If your vehicle is not compatible, you will need to use the manual trigger wire. Make sure Blind Spot activation is turned on using the ARC 357 PC Configuration Tool. *By default, this feature is turned off in Firmware 1.9 and newer*

Before Installing:

Disconnect negative battery terminal before beginning installation!

DIP Switches must be set before installation of interface module!

For vehicle specific instructions for dash disassembly, reference workshop manual.

Default Auxiliary Camera Behavior

Front/Aux/Cargo Mode DIP Switch #6 = OFF	Blind Spot/Aux Mode DIP Switch #6 = ON
<ul style="list-style-type: none"> • Speed Limited to 7MPH* • No activation time limit • For off-road use only • Backup Camera Priority over Auxiliary Camera* 	<ul style="list-style-type: none"> • Time Limited to 30 Seconds* • No activation speed limit • Automatic right blind spot triggering in compatible vehicles*

**Can be adjusted with ARC-357 PC Configuration Tool*

Install Rear Camera

Part 1

Camera functionality test (Highly recommended, not required)

1. 8837:

- a. There will be three wires accompanying the RCA: Red, Green, and Black
 1. Twist red and green together = Power
 2. Black = Ground
- b. Using an wire extension (not supplied)
 1. Connect twisted red and green directly to positive terminal of battery
 2. Connect Black to negative terminal of battery
- c. Test Camera
 1. Connect RCA to Aftermarket radio and
 2. Turn Key to on position
 3. Place the vehicle in reverse and verify a good image.

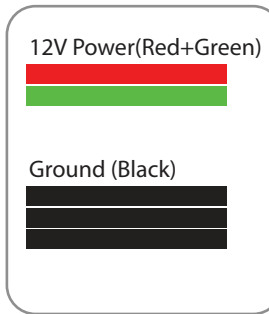

2. 8847:

- a. There will be two wires at the rear of the harness near the camera
 1. Red= Power
 2. Black = Ground
- b. Using an wire extension (not supplied)
 1. Connect red wire directly to positive terminal of battery
 2. Connect Black to negative terminal of battery
- c. Test Camera
 1. Connect RCA to Aftermarket radio and
 2. Turn Key to on position
 3. Place the vehicle in reverse and verify a good image.

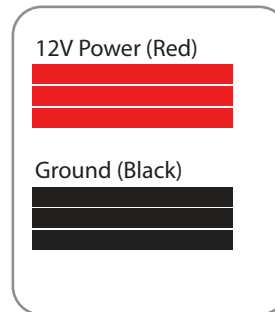

3. 8857:

- a. There will be two wires accompanying the RCA: Red and Black
 1. Red= Power
 2. Black = Ground
- b. Using an wire extension (not supplied)
 1. Connect Red wire directly to positive terminal of battery
 2. Connect Black to negative terminal of battery
- c. Test Camera
 1. Connect RCA to Aftermarket radio
 2. Turn Key to on position
 3. Place the vehicle in reverse and verify a good image.

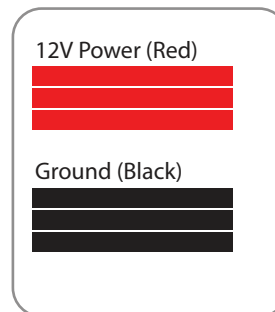

Part 2

Installing Rear Camera on Tire Carrier

1. Remove your spare tire and place the camera bracket on the top two studs.
2. Secure bracket to carrier using (2) push nuts to secure the bracket on two top studs.
3. The nylon washer will go on the bottom stud and will be secured with the third push nut.
4. Place your tire on the carrier and make any needed adjustments to the camera placement to see through the wheel spokes.
5. Once the orientation is satisfactory, tighten two adjustment screws on bracket.
6. Reinstall the spare tire on the carrier.



Install Rear View Camera Chassis Harness

1. Using a plastic trim removal tool, remove interior panels on the inside of the rear gate
2. Insert camera connector through the rear relief/vent flap behind the spare tire mount. **DO NOT RUN THROUGH CENTER HOLE OF TIRE CARRIER**
3. Gently pull harness through relief door and connect your camera harness to your chassis harness.
4. Use supplied wire ties to secure chassis harness to existing harness in the tailgate.

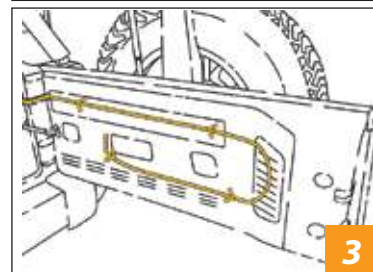
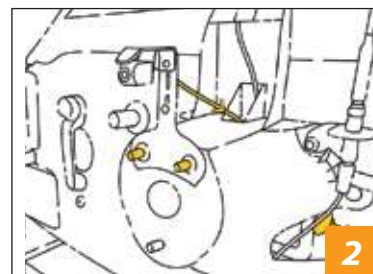

5. Use supplied wire ties to secure chassis harness to exterior of fabric factory wire cover connecting tailgate to body. Do not run through fabric factory wire cover. **CAUTION: Leave enough slack to allow the gate to open fully**
6. Using a plastic trim removal tool, remove rear access (behind seat belt) panel to expose 10mm bolt, and remove bolt. Failure to remove this bolt will break the panel.
7. Remove interior rear quarter panel
8. FOR 8848, you will need to ground black wire at a good chassis ground. Isolate the red wire with electrical tape. You will connect to power at the front of the vehicle in later steps.
9. Pull back carpet and continue running chassis harness forward under sill plates and B-pillar cover to passenger kick panel
10. Use a plastic trim removal tool to remove the (2) plastic push pins and remove passenger sill plate/kick panel.
11. Run the chassis harness behind the glove box and into the radio cavity.

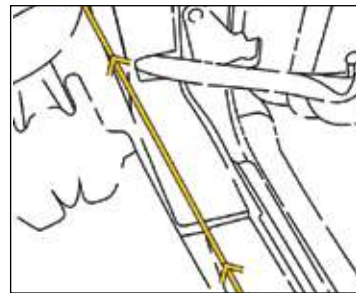
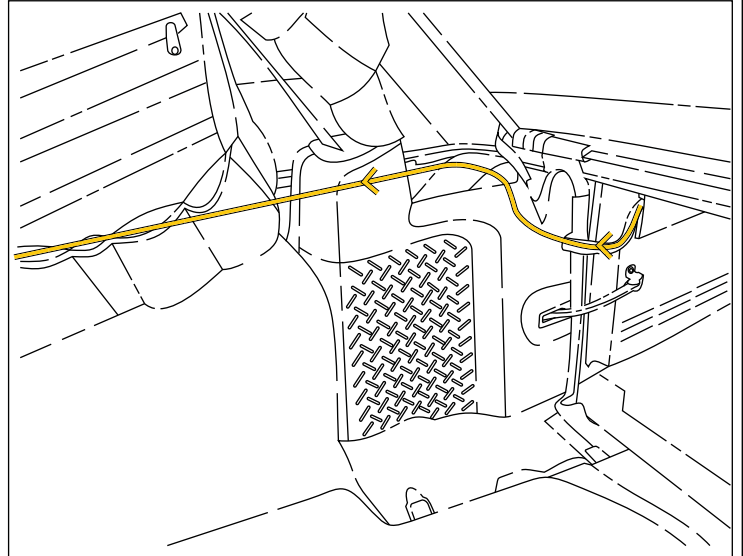

Connecting to Power

Part 1

1. 8837:
 - a. There will be three wires accompanying the RCA in the passenger kick panel: Red, Green, and Black
 1. Twist red and green together = Power
 2. Black = Ground
 - b. Identify power output from your aftermarket radio

12V Power (Red+Green)



Ground (Black)



- c. Connect twisted red and green wire to power output from radio
- d. Connect black wire to Chassis ground. We recommend using factory chassis grounding point.

2. 8847:

- a. Identify red power wire exiting the back of the yellow RCA from your camera chassis harness
- b. Identify power output from your aftermarket radio
- c. Connect Red wire to power output from your aftermarket radio
- d. Connect black wire to Chassis ground. We recommend using factory chassis grounding point.

3. 8857:

- a. Connect jumper power harness to chassis harness (if not already connected)
- b. Separate power and ground wires at jumper harness
 - 1. Red = Power
 - 2. Black = Ground
- c. Identify power output from your aftermarket radio
- d. Connect red wire to power output from your aftermarket radio.
- e. Connect black wire to Chassis ground. We recommend using factory chassis grounding point.

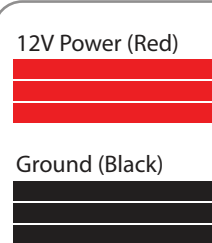
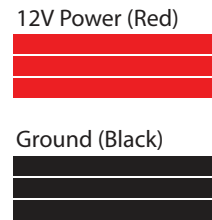

Jeep Wrangler JK 12V Power Location
(White/Grey wire by passenger kick panel)

Kit Contents

Part 1

Install Forward Facing Camera

1. Power the camera harness with 12V, connect the camera to the harness and plug the Yellow RCA into the video in port to test the camera functionality.
2. Route the harness away from any moving parts so the harness will not get cut. Enter the underhood area and secure to the harness running along the driver's side fender with zip ties.
3. Route the camera harness into the vehicle's interior through the factory grommet in the firewall on the driver's side.
4. Route the harness to the back of the radio where the display interface will be.
5. We recommend to connect to 12V+ from a vehicle ignition source. The ground should be located on a chassis ground point.



FAQ Section

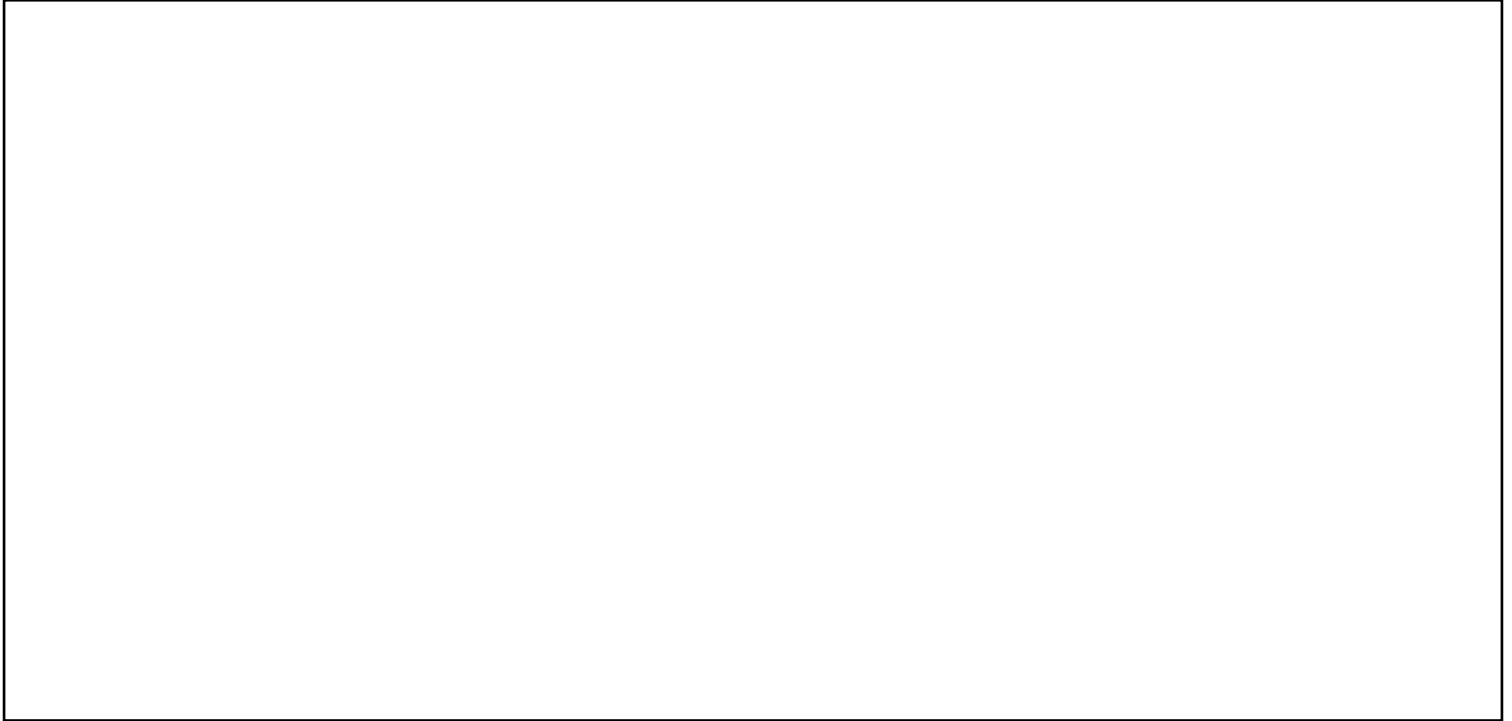

**WARNING: Cancer and Reproductive Harm -
www.P65Warnings.ca.gov**