



**JEEP- TJ (NON- INTERCOOLED)**  
**HARDWARE ONLY SUPERCHARGER SYSTEM**  
**(TO SUIT 1997- 2004 MODEL VEHICLES)**  
**257A1007**



**INSTALLATION INSTRUCTIONS**

Kit Serial # \_\_\_\_\_  
Supercharger Serial # \_\_\_\_\_

---

---

## Table of Contents

INTELLECTUAL PROPERTY USED IN THIS PUBLICATION _____	- 4 -
IMPORTANT INFORMATION _____	- 5 -
SAFETY WARNING _____	- 6 -
CHANGES TO FACTORY SPECIFICATIONS _____	- 6 -
RECORD OF AMENDMENTS _____	- 8 -
PARTS SUPPLIED _____	- 9 -
DISASSEMBLY INSTRUCTIONS _____	- 11 -
<b>PREPARATION</b> _____	- 12 -
1. DISCONNECT BATTERY _____	- 14 -
2. LOOSEN FUEL FILLER CAP _____	- 14 -
3. DISCONNECT AIR TEMP SENSOR FROM THE AIR INLET PIPE _____	- 15 -
4. REMOVE AIR INLET PIPE _____	- 15 -
5. REMOVE THROTTLE CABLE BRACKET _____	- 16 -
6. REMOVE THROTTLE BODY AND GASKET _____	- 16 -
7. DISCONNECT ENGINE BREATHER AND BRAKE BOOSTER HOSES _____	- 17 -
8. DETACH CABLE CONDUIT FROM THE MANIFOLD _____	- 17 -
9. REMOVE ENGINE ACCESSORY DRIVE BELT _____	- 18 -
10. REMOVE 2 SCREWS OF THE POWER STEERING PUMP _____	- 18 -
11. REPLACE CRUISE CONTROL BRACKET (IF EQUIPPED) _____	- 19 -
INSTALLATION INSTRUCTIONS _____	- 20 -
1. BLANK OFF MANIFOLD IAT SENSOR PORT _____	- 20 -
2. BLANK OFF MANIFOLD VACUUM PORTS _____	- 21 -
3. REPLACE FUEL INJECTORS _____	- 21 -
4. EXTEND THE WIRES OF TPS AND IAC SENSORS (IF NECESSARY) _____	- 24 -
5. FIT CABLE CONDUIT _____	- 24 -

---

6. REMOVE ADAPTOR WITH PLUG ON THE CABLE CONDUIT AND RELOCATE	- 25 -
7. FIT DISCHARGE ASSEMBLY TO THE MANIFOLD _____	- 26 -
8. BEND THE REAR AIR-CONDITIONER PIPE (L/H DRIVE VEHICLES ONLY)	- 27 -
9. FIT SUPERCHARGER ASSEMBLY TO THE DISCHARGE ASSEMBLY _____	- 28 -
10. FIT IDLER PULLEY BRACKET & POWER STEERING PUMP _____	- 29 -
11. FIT NEW THROTTLE CABLE BRACKET _____	- 30 -
12. FIT THROTTLE BODY _____	- 31 -
13. GLUE BAYONET ADAPTOR TO THE NEW AIR INLET PIPE _____	- 32 -
14. FIT NEW AIR INLET PIPE _____	- 33 -
15. FIT THE FACTORY AIR TEMP SENSOR _____	- 33 -
16. HOLD THE THROTTLE CABLE IN POSITION _____	- 34 -
17. FIT BREATHER AND VACUUM LINES _____	- 34 -
18. INSTALL BLANKING PLUG FOR T-MAP SENSOR _____	- 35 -
19. PLUG IN ELECTRICAL COMPONENTS _____	- 35 -
20. FIT NEW ACCESSORY DRIVE BELT _____	- 35 -
21. RECONNECT BATTERY _____	- 37 -
22. INSTALL PREMIUM UNLEADED FUEL STICKER _____	- 38 -
<b>PRE TEST-DRIVE INSPECTION _____</b>	<b>- 39 -</b>
PRE-START INSPECTION _____	- 40 -
ENGINE WARM UP _____	- 40 -
ROAD TEST VEHICLE _____	- 40 -
<b>MAINTENANCE INSTRUCTIONS _____</b>	<b>- 41 -</b>
1. SUPERCHARGER DRIVE BELT REPLACEMENT _____	- 42 -
2. SUPERCHARGER REMOVAL _____	- 43 -
3. SUPERCHARGER LUBRICATION SERVICE _____	- 44 -
4. SPARK PLUGS _____	- 44 -

---

---

---

## **Intellectual Property used in this Publication**

This document is copyright of **Sprintex Ltd**, a company incorporated in Australia. This document may not be re-sold, copied or distributed in any way without prior written authorisation of Sprintex Ltd.

### **Copyrights / Trademarks:**

Sprintex® is a registered trademark of Sprintex Limited, an Australian company ACN: 106 337 599 (“Sprintex”). Sprintex has patents for its superchargers. Any unauthorised copying or modification of the system may result in legal action.

Loctite® and Grey Maxx® are registered trademarks of Henkel KGaA, a company incorporated in Germany. Other than commercial supply arrangements, Henkel KGaA does not have any association with Sprintex.

RedLine® is a registered trademark of RedLine Synthetic Oil Corporation, a company incorporated in the United States of America. Other than commercial supply arrangements, Redline and RedLine Synthetic Oil Corporation do not have any association with Sprintex.

Jeep, Jeep - JK, Jeep & Wrangler are registered trademarks of FCA US LLC, formerly Chrysler Group LLC. A company Headquartered in Auburn Hills, MI, USA. (<http://www.fcausllc.com>)

SAE is a trademark of SAE International ([www.sae.org](http://www.sae.org)), global technology information and standards setting resource organisation for the design, manufacturing, operation, and maintenance industry.

Gates is a registered trademark of the Gates Rubber Company, a subsidiary of Tomkins PLC, incorporated in London, United Kingdom. Other than commercial supply arrangements, Gates and Tomkins PLC do not have any association with Sprintex Limited.

---

# **IMPORTANT INFORMATION**

## **PRODUCT WARNING**

Installation of the Sprintex Supercharger system on your Jeep- TJ vehicle may void all or parts of Jeep Warranty. Customers should consult their Jeep dealer for details.

Sprintex makes no representation that installation and use of the Sprintex supercharger system is legal for public road use worldwide. Customers should check that installation and use of the Sprintex supercharger system on their vehicle is legal by contacting the relevant statutory authority in their jurisdiction prior to use on roads.

**Sprintex supports safe driving. So always remember to observe all speed limits and road rules relevant to your state, city or jurisdiction.**

Provided in this installation manual are detailed instructions to the installer on how to install the Sprintex patent pending supercharger system to the Jeep- TJ vehicle. The instructions are aimed at being simple yet informative, and are aided with well-presented pictures to make installations as simple, fast, and problem free as possible. **Please read the entire instruction manual prior to beginning the installation procedure.** Pictures and descriptions may vary slightly from model to model.

It is recommended that all wiring harness connectors, and vacuum hoses are labelled at the time of removal for easy and correct refitting. Some components that are removed and are to be refitted are fragile, and should be stored safely to prevent damage to these components.

**Sprintex recommends performing the following vehicle checks prior to installing the supercharger.**

- 1. Check that the factory fuel system is operating correctly.**
- 2. Inspect the factory exhaust catalyst for blocks or damage**
- 3. Ensure that the vehicles ignition system is working correctly.**
- 4. Install new standard spark plugs and set gap.**
- 5. Replace the fuel filter if the vehicle has travelled more than 15,000 Km or 9000 miles.**
- 6. It is recommended to run at least one full tank of premium unleaded fuel through the vehicle prior to installing the supercharger system to prevent any possible damage that may occur due to running the supercharged engine on lower octane fuel. (Refer details on the next page)**

Sprintex will not be liable for any loss, damage, payment, costs, expenses or other liability, not expressly stated in this document. In particular, Sprintex shall not be liable to any person for any consequential, indirect or economic loss or punitive or exemplary damages of any kind.

Sprintex reserves the right to change specifications from time to time and will not be liable to any person or entity for doing so. Sprintex believes that information in this document is correct at time of print. Sprintex limits its liability to the maximum extent permissible at law with regard to the reliance which any person places on anything in this document.

**THIS SPRINTEX INSTALLATION REQUIRES THAT YOUR VEHICLE BE FITTED WITH A STANDARD JEEP-TJ FACTORY ECU AND CALIBRATION.**

**FINAL CALIBRATION IS THE RESPONSIBILITY OF THE CUSTOMER.**

---

---

**California residents:**

California Proposition 65 entitles California to special warnings for products that contain chemicals known to the state of California to cause cancer and birth defects or other reproductive harm.



## **WARNING**

This product can expose you to chemicals including Cumene, which is known to the State of California to cause cancer or birth defects or other reproductive harm.

For more information, visit

[www.P65Warnings.ca.gov](http://www.P65Warnings.ca.gov).

## **SAFETY WARNING**

No unauthorised service or alteration may be undertaken to the Sprintex supercharger or related parts. Installation should be carried out in a workshop which is a safe and ventilated working environment with equipment and procedures compliant with local authority guidelines and legal requirements. Installers should ensure adequate hearing, eye and other appropriate personal protective equipment is used at all times during the installation process. Installers should take reasonable precautions to avoid fatigue and closely follow the installation instructions during every installation. Sprintex recommends installation should not be carried out unsupervised. Sprintex, its directors, employees and agents will not accept liability for damage accident or injury resulting from the installation process. Safety warnings are also provided throughout this document.

## **CHANGES TO FACTORY SPECIFICATIONS**

**FUEL: MINIMUM 95 RON (91 Octane USA) PREMIUM UNLEADED GASOLINE/FUEL TO BE USED AT ALL TIMES. NEVER ALLOW THE ENGINE TO KNOCK OR DETONATE AS SERIOUS ENGINE DAMAGE MAY OCCUR.**

**REQUIRED SERVICE: (SEE MAINTENANCE SECTION OF MANUAL)**

1. **INSPECT THE SUPERCHARGER DRIVE BELT AT EVERY ROUTINE SERVICE AND REPLACE WHEN REQUIRED.**
2. **DRAIN AND REPLACE SUPERCHARGER OIL EVERY 40,000 km (25,000 miles) or 2 YEARS (whichever is earlier).**
  - **SUPERCHARGER IS SUPPLIED WITH REDLINE 75W90 NS GEAR OIL.**  
**FILL WITH 157 millilitres or 5.31 US fluid ounces OF FULLY SYNTHETIC SAE 75W90 GEAR OIL (SPECIFICATIONS: API GL5, MT-1).**
  - **CHECK OIL LEVEL WITH THE DIPSTICK PROVIDED IN THE SUPERCHARGER ASSEMBLY. TIGHTEN DIPSTICK FULLY AND THEN CHECK THE OIL LEVEL.**

- 
3. OIL LEVEL SHOULD BE CHECKED WITH THE DIPSTICK PERIODICALLY (RECOMMENDED EVERY WEEK AND ALSO BEFORE & AFTER A LONG JOURNEY).



Oil level mark

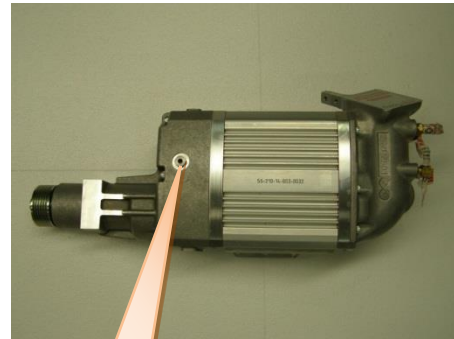

Dipstick

**Note:**

1. Many of the photos shown in this document are of a typical Jeep- TJ Right hand drive vehicle and are similar to a typical Jeep- TJ Left hand drive vehicle.
2. Some of the terminology and language used in this instruction may vary from that of the end user / installer's expectations, as some tools and automotive components have different common names in different geographical locations.

## Tools and Consumables Required to Complete Installation

Metric Wrenches and Socket Sets	Cable Ties	Cobra clamp pliers
Metric Allen keys	Electrical Tape	Solder and Soldering Gun
Flat and Philips Screwdrivers	Loctite 577 thread locker	Rubber grease or Silicone spray
Pliers and Side Cutters	Loctite 406	½" Breaker bar
Fuel line disconnect tool		

## Record of Amendments

No.	Revision	Action	Date	Completed by	Approved by
1	1.00	Production Release, created based on the Full Kit manual	6 Mar 2015	Marius P.	Jay U.
2	1.01	Six fuel injectors included to the hardware only system. Supercharger oil specification and replacement information updated.	4 Dec 2015	Deepak S	Jay U.
3	1.02	Installation instructions added for new item: Sticker, premium unleaded fuel.	7 Dec 2016	Marius P.	Adrian de Kock
4	1.03	Six fuel injector adaptors (EV6 Female to EV1 Male) included to support old version models with EV1 style Plugs in the wiring harness. Torque values are now stated in Nm and ft-lb. Sections with multiple photos now have letters identifying the pictures. California Prop 65 Warning Added	27 Mar 2017	Deepak S	Adrian de Kock
5	2.00	Add step to fit Supercharger discharge O-ring	11 August 2017	J. Stephens	Adrian de Kock

Abbreviations (Symbols)	Reference
SHCS	Socket Head Cap Screw
MAP	Manifold Absolute Pressure
T-MAP	Temperature & Manifold Absolute Pressure
TPS	Throttle Position Sensor
IAC	Idle Air Control



## PARTS SUPPLIED

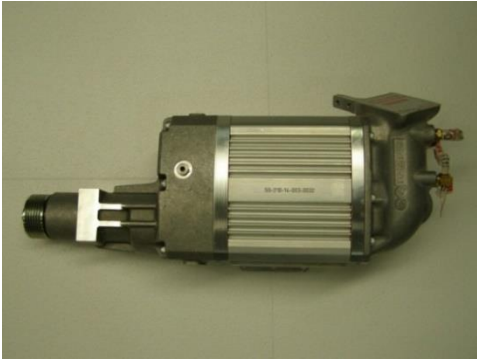

**Supercharger assembly with air intake housing**



**Discharge assembly**

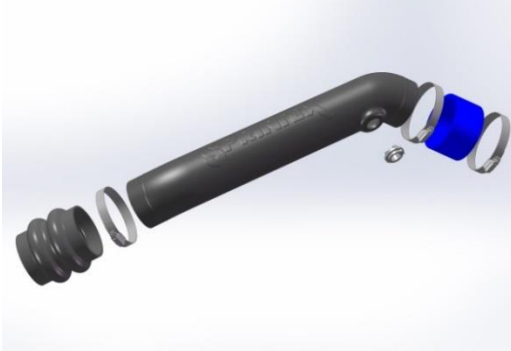

**Inlet pipe assembly**



**Throttle cable bracket assembly**



**Idle pulley bracket assembly & drive belt**



**Ancillary parts assembly**



**Sticker, premium unleaded fuel**

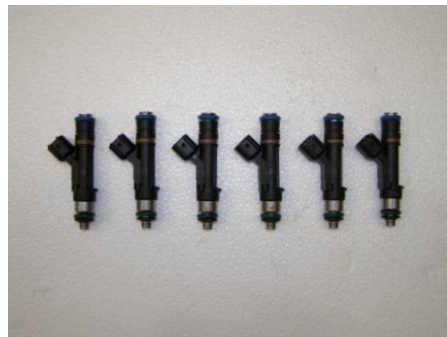

**Fuel injectors**



**Fuel injector adaptors**

- |  |   |
|--|---|
| <ol style="list-style-type: none"> <li>1. Sprintex® Supercharger assembly with intake housing</li> <li>2. Discharge Assembly with non-intercooled duct (T-Map sensor replaced with a bolted plug)</li> <li>3. Inlet pipe assembly</li> <li>4. Throttle cable bracket, Cruise controller bracket (optional part)</li> </ol> | <ol style="list-style-type: none"> <li>5. Idler pulley bracket assembly and drive belt</li> <li>6. Fuel injectors (6x)</li> <li>7. Fuel injector adaptors (6x)</li> <li>8. Ancillary parts</li> <li>9. Installation Manual</li> <li>10. Sticker, premium unleaded fuel</li> </ol> |
|--|---|

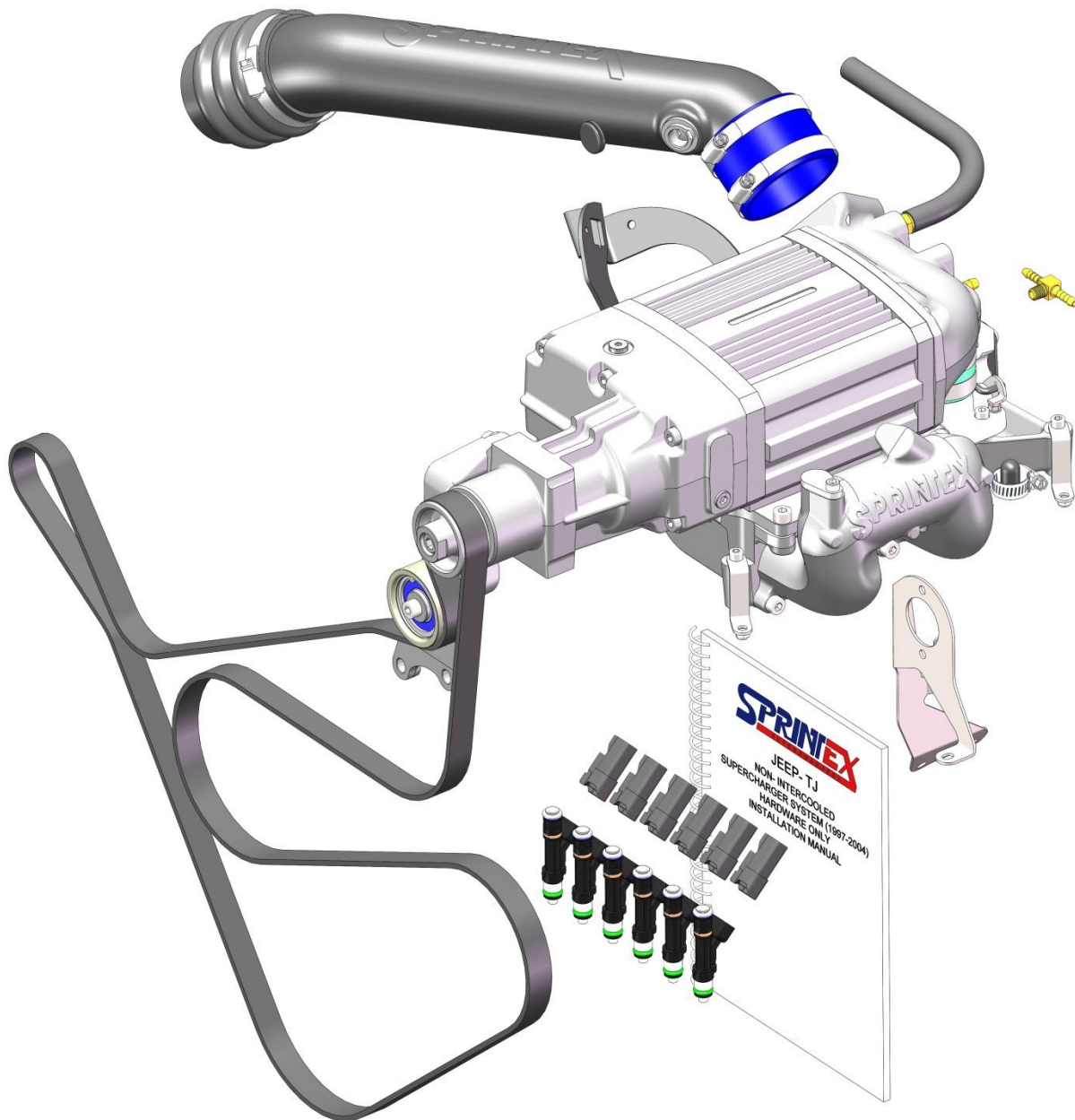

---

# **JEEP- TJ HARDWARE ONLY SUPERCHARGER SYSTEM** **(NON- INTERCOOLED)**

## **SECTION 1**

### **DISASSEMBLY INSTRUCTIONS**

#### **SAFETY WARNING**

No unauthorised service or alteration may be undertaken to the Sprintex supercharger. Installation should be carried out in a workshop which is a safe and ventilated working environment with equipment and procedures compliant with local authority guidelines and legal requirements. Installers should ensure adequate hearing, eye, and physical protection is used at all times during the installation process. Installers should take reasonable precautions to avoid fatigue and closely follow the installation instructions during every installation. Sprintex recommends installation should not be carried out unsupervised. Sprintex, its directors, employees and agents will not accept liability for damage accident or injury resulting from the installation process. Safety warnings are also provided throughout this document.

# JEEP- TJ (NON- INTERCOOLED) SUPERCHARGER SYSTEM

---

## Preparation

Ensure that all components required to assemble the supercharger are available. Refer to the Parts Supplied section provided earlier.

Ensure that all required tools are available.

Please read the entire instruction manual prior to beginning the installation procedure.

Ensure vehicle is located in a secure position with vehicle tyres secured and handbrake applied. Sprintex® recommends to avoid injury you should use a vehicle lift or axle stands when the vehicle is required to be lifted for access. Stands should be positioned as per the Manufacturers Owners Handbook.

**SAFETY WARNING:** Use Personal Protective Equipment such as safety glasses, gloves, etc. at all times and as necessary.

**SAFETY WARNING:** Allow engine to cool prior to proceeding with disassembly to prevent scalding.

**SAFETY WARNING:** The fuel system is under high pressure. Ensure to take care and follow procedures as mentioned in the vehicle's workshop manual while working with the fuel system.

**Note:** During disassembly and removal of components, take notes and ensure to label and store them safely; this will help with the reassembly.

**Note:** Many of the photos shown in this document are of a typical Jeep- TJ right hand drive vehicle and are similar to a typical Jeep- TJ left hand drive vehicle.



**Left hand drive vehicle**



**Right hand drive vehicle**

## JEEP- TJ (NON- INTERCOOLED) HARDWARE ONLY SUPERCHARGER SYSTEM

---

### **Caution:**

Connect and disconnect battery cables, jumper cables or battery charger only with the ignition switched off

### **Warning:**

Disconnecting the battery may erase fault codes stored in control module memory. Using diagnostic equipment, check for fault codes before disconnecting battery cables. If the malfunction indicator light (MIL) is illuminated.

### **MIL (Malfunction Indicator Lamp) light.**

The MIL light can be found in one of two locations, dependant on the market the vehicle has been built for.

1. The MIL light may be an illuminated **ENGINE** symbol within the speedometer cluster.
2. The MIL light may be displayed as **SERVICE ENGINE SOON** within the Revolution counter.

Please refer to your **OWNERS HANDBOOK** to define which of the above applies to your vehicle.

### **Note:**

**Always disconnect the negative battery terminal before disconnecting the positive terminal. This prevents possible shorting and potential battery damage.**

# JEEP- TJ (NON- INTERCOOLED) HARDWARE ONLY SUPERCHARGER SYSTEM

---

## 1. Disconnect Battery

The Jeep- TJ battery is located in the passenger side corner of vehicle (LH & RH drive).

1. First disconnect negative (-) battery cable.
2. Lift positive (+) terminal plastic cover, then disconnect positive (+) cable.



## 2. Loosen fuel filler cap

Loosen fuel filler cap to relieve pressure in the system.



### **3. Disconnect air temp sensor from the air inlet pipe**

1. Disconnect wiring to factory air temp sensor.
2. Remove factory air temp sensor and store in a safe location.

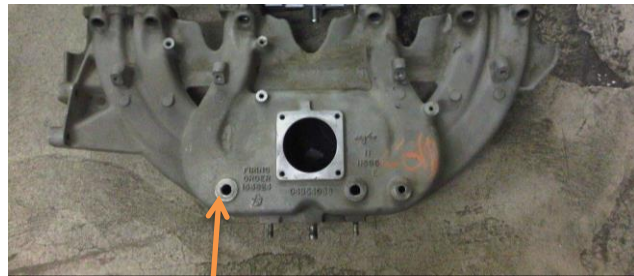
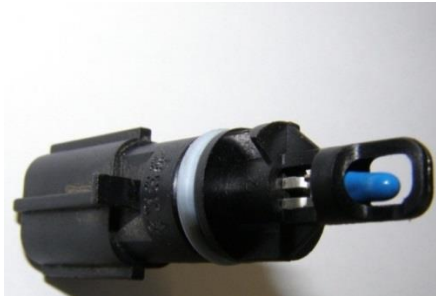

Air temp sensor location

### **4. Remove air inlet pipe**

1. Loosen hose clamps on each end of the pipe and remove the air inlet pipe.
2. Remove the hose clamps and store in a safe location.
3. Cover the air box outlet with sealing tape to avoid dirt and foreign particles entering the assembly.



Remove hose clamps

## **5. Remove throttle cable bracket**

1. Disconnect throttle cable, optional cables like cruise control cable, line pressure cable (kick down cable) from the throttle cable bracket.
2. Remove 2x M6 SHCS screws, throttle cable bracket and store in a safe location.



Remove throttle cable bracket

## **6. Remove throttle body and gasket**

1. Disconnect wiring plugs from the throttle body.
2. Remove 4x M6 Hex head screws, throttle body with gasket and store in a safe location.
3. Seal the throttle hole with sealing tape to avoid dirt and foreign particles entering manifold.

**NOTE:** The gasket is re-used in the assembly at a later stage. So check the condition of the gasket and replace, if necessary.

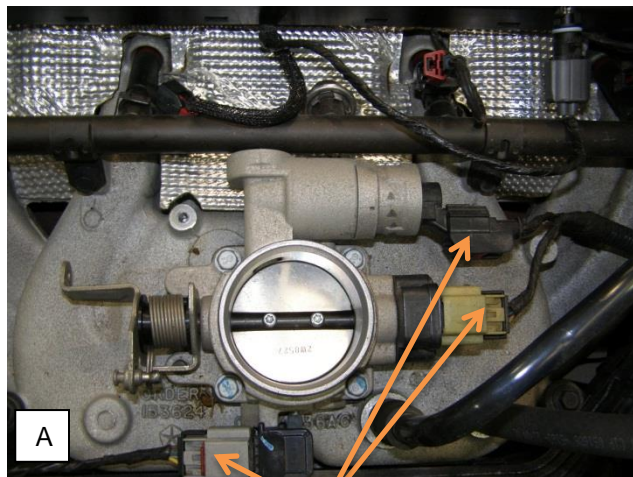

Disconnect plugs



## JEEP- TJ (NON- INTERCOOLED) HARDWARE ONLY SUPERCHARGER SYSTEM



### **7. Disconnect engine breather and brake booster hoses**

1. Disconnect Engine breather and brake booster hoses from the manifold.
2. Seal the manifold holes with sealing tape to avoid dirt and foreign particles entering manifold.

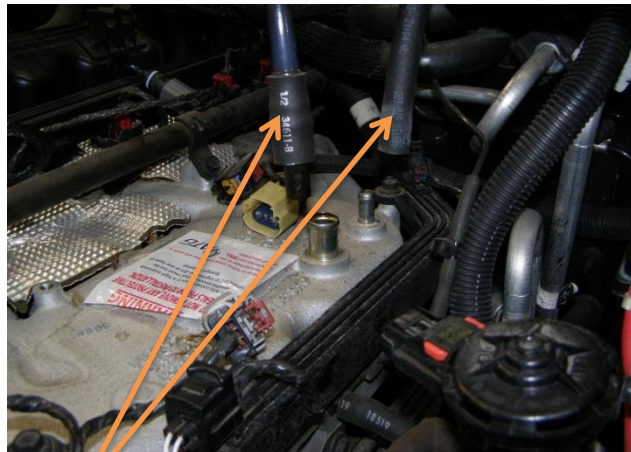

Disconnect hoses

### **8. Detach cable conduit from the manifold**

1. Remove the cable conduit from the manifold and store the screws in a safe location.

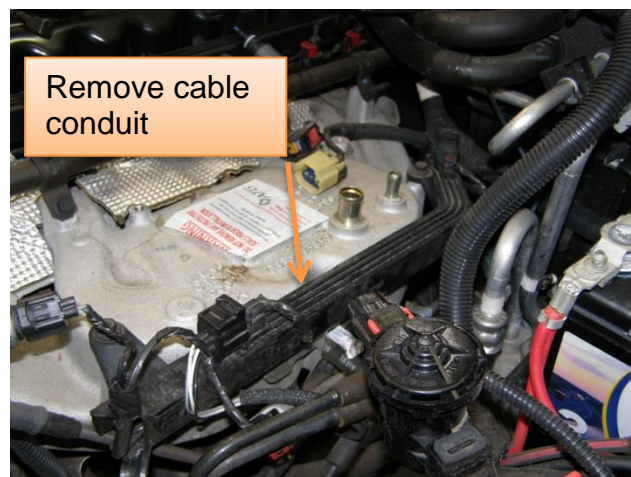

Remove cable conduit

**JEEP- TJ (NON- INTERCOOLED) HARDWARE ONLY  
SUPERCHARGER SYSTEM**

**9. Remove engine accessory  
drive belt**

Remove the drive belt using long series 1/2" breaker bar, to release the dynamic tensioner. Store the used belt in a safe location.

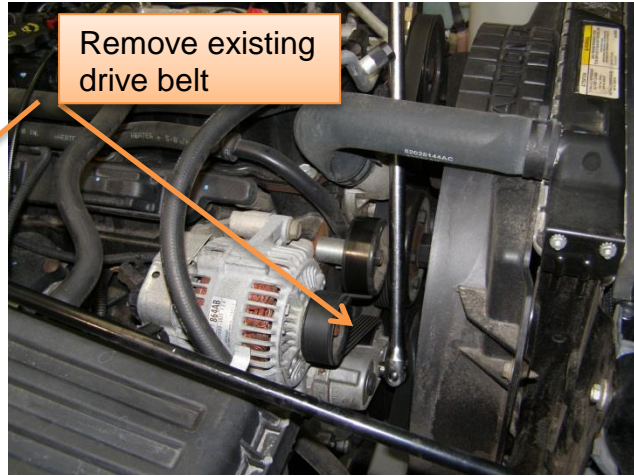

**10. Remove 2 screws of the  
Power steering pump**

Remove 2x M8 screws and store in a safe location.

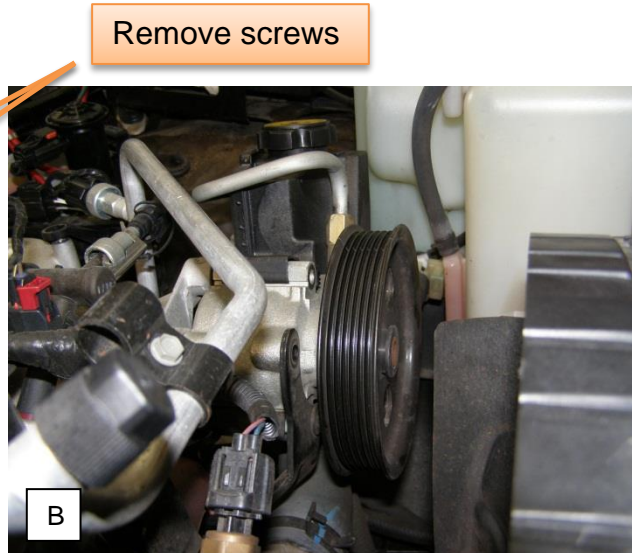
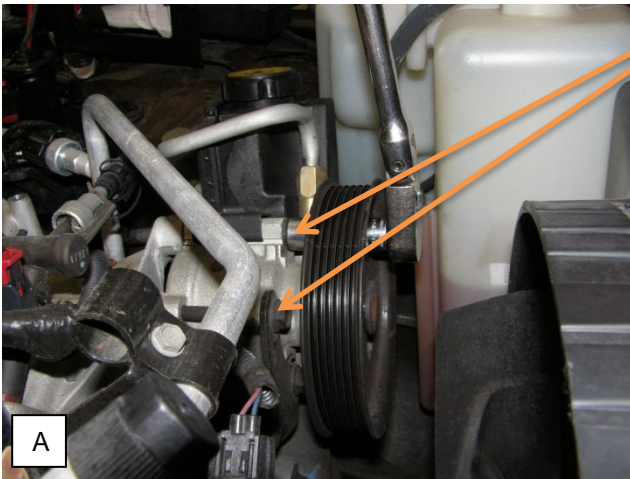

**11. Replace Cruise control  
bracket (if equipped)**

1. Disconnect wiring plug and hose from the cruise control unit
2. Remove 2 nuts and remove cruise control unit, cruise control cable from the standard factory steel bracket.
3. Remove carbon canister unit from the standard factory steel bracket.
4. Remove 3x M6 hex head screws and remove the factory steel bracket.
5. Fit the supplied new cruise control bracket with the previously removed factory screws.
6. Fit the cruise control unit, cruise control cable and carbon canister unit back into the new steel bracket.
7. Reconnect wiring plug and hose to the cruise control unit



Remove standard bracket

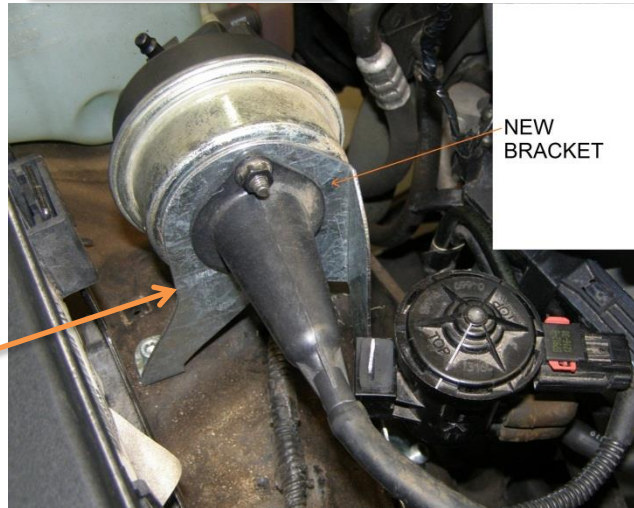

Fit new bracket

# **JEEP- TJ HARDWARE ONLY SUPERCHARGER SYSTEM** **(NON- INTERCOOLED)**

## **SECTION 2**

### **INSTALLATION INSTRUCTIONS**

#### **SAFETY WARNING**

No unauthorised service or alteration may be undertaken to the Sprintex supercharger. Installation should be carried out in a workshop which is a safe and ventilated working environment with equipment and procedures compliant with local authority guidelines and legal requirements. Installers should ensure adequate hearing, eye, and physical protection is used at all times during the installation process. Installers should take reasonable precautions to avoid fatigue and closely follow the installation instructions during every installation. Sprintex recommends installation should not be carried out unsupervised. Sprintex, its directors, employees and agents will not accept liability for damage accident or injury resulting from the installation process. Safety warnings are also provided throughout this document.

#### **ASSEMBLY**

##### **1. Blank off manifold IAT sensor port**

1. Blank off IAT (Intake Air Temperature) port for manifolds for models prior to 2005.
2. Sprintex recommends that the manifolds on vehicles manufactured prior to 2005 are replaced with the newer manifolds (top of the picture) which have an extra tapping and do not require blanking of the IAT sensor port.
3. Relocate the IAT sensor to the new air inlet pipe at a later stage (step 13).

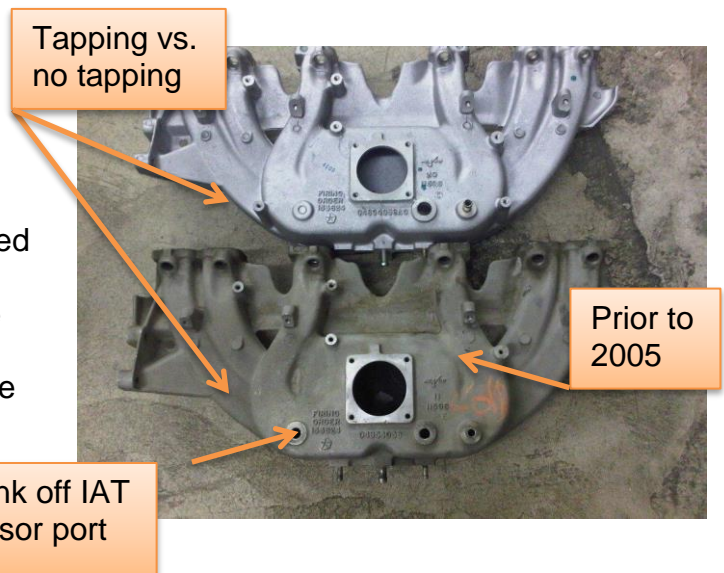

# JEEP- TJ (NON- INTERCOOLED) HARDWARE ONLY SUPERCHARGER SYSTEM

## 2. Blank off manifold Vacuum ports

1. Blank off vacuum ports for the engine breather, brake booster with the supplied 3/8" & 5/8" plugs and clamps.
2. Alternative rubber blanks might be supplied in the kit.

**NOTE:** If not using proper pliers, damage can occur to the clamps.

**WARNING:** The fuel system is under high pressure.

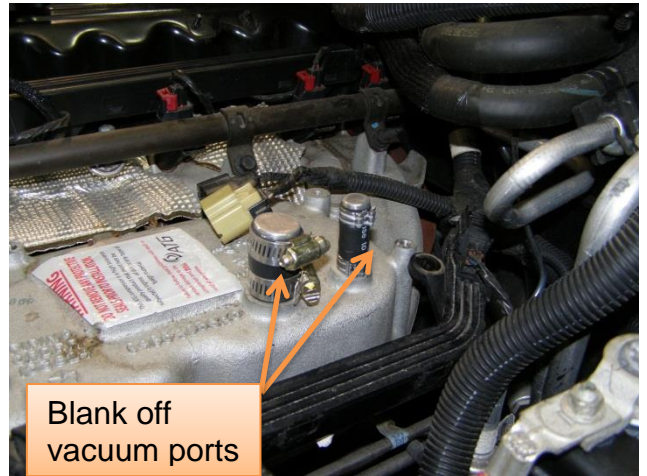

Alternative rubber blanks

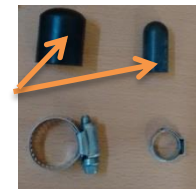

## 3. Replace fuel injectors

1. Disconnect fuel line fitting using fuel line removal tool
2. Disconnect plugs from the fuel injectors (6x)
3. Remove fuel rail mounting screws (2x) and nuts (2x) and gently lift fuel rail assembly out.

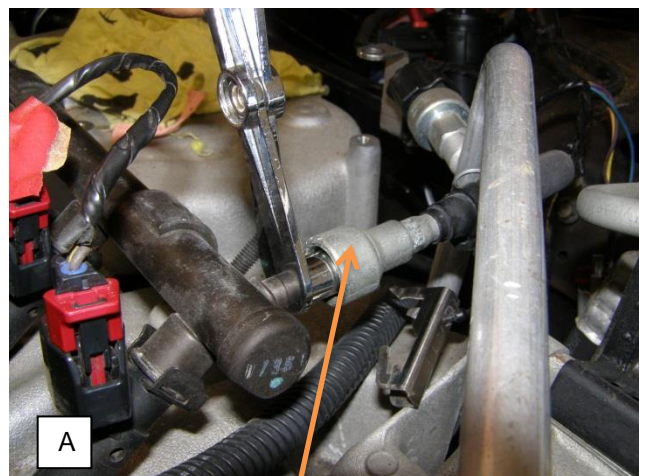

Disconnect fitting

# JEEP- TJ (NON- INTERCOOLED) HARDWARE ONLY SUPERCHARGER SYSTEM



Remove screws and nuts

4. Remove the injector retaining clips from fuel rail assembly.
5. Remove existing standard fuel injectors (6x) and store in a safe location.
6. Fit new supplied fuel injectors 0280158193 (6x) and ensure orientation. Apply a thin layer of rubber grease to the O-Rings of injectors for ease of fitting.
7. Fit the retaining clips back to hold the injectors securely.
8. Fit the fuel rail back with previously removed standard screws and nuts.

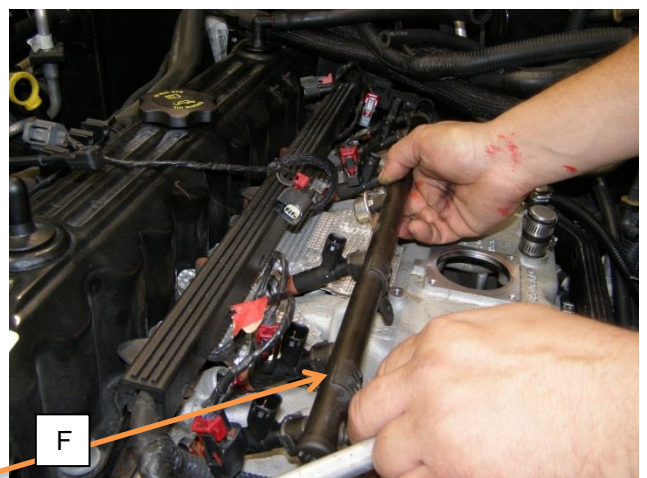
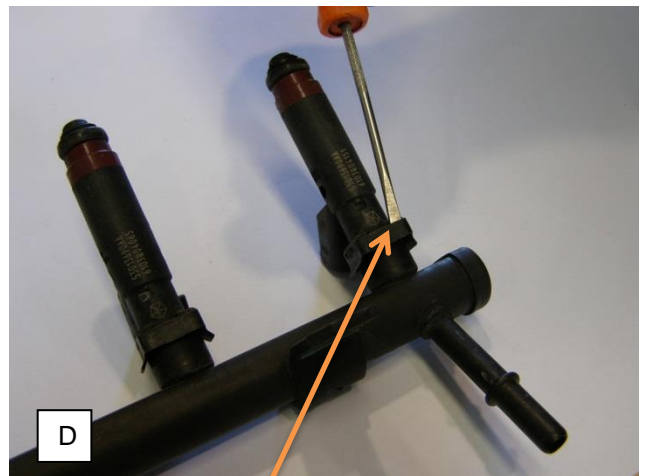
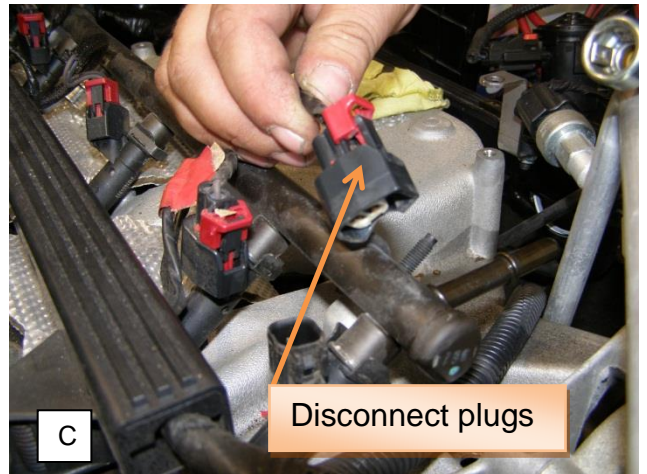

# JEEP- TJ (NON- INTERCOOLED) HARDWARE ONLY SUPERCHARGER SYSTEM

9. Connect the plugs back into the fuel injectors



Connect plugs  
back into position

10. **Connect Fuel injector adaptors to the wiring harness and injectors (OPTIONAL):**

For stock vehicles equipped with EV1 style injectors and wiring harness plugs, use the supplied injector adaptors.

The injectors supplied with the supercharger system are EV6 USCAR style injectors. Injector adaptors are required to adapt the supplied injectors to the vehicle wiring harness.



EV6 Female to  
EV1 Male injector  
adaptor

11. Reconnect the fuel line fitting to the fuel rail



Reconnect fuel  
line fitting

## JEEP- TJ (NON- INTERCOOLED) HARDWARE ONLY SUPERCHARGER SYSTEM

### **4. Extend the wires of TPS and IAC sensors (if necessary)**

1. Carefully strip back wiring harness 50mm to separate TPS and IAC plugs.
2. Extend the wires of TPS plug by approximately 200mm (8")
3. Extend the wires of IAC plug by approximately 200mm (8")
4. Wrap the wires with split sleeve conduit and insulation tape.

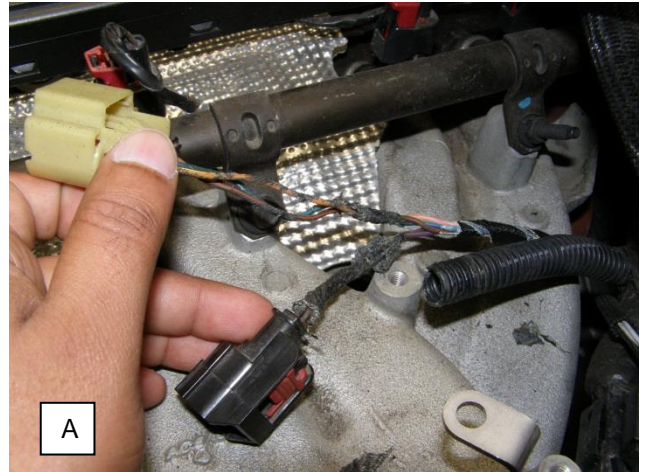

A

**TPS before Modification**

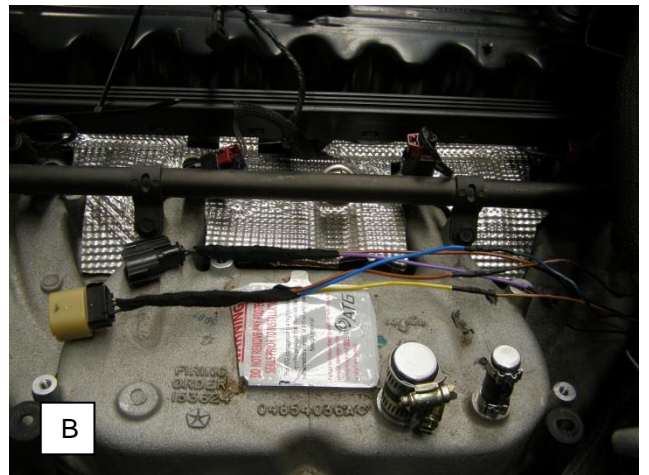

B

**TPS and IAC after Modification**

### **5. Fit cable conduit**

1. Fit the cable conduit using previously removed factory screws.

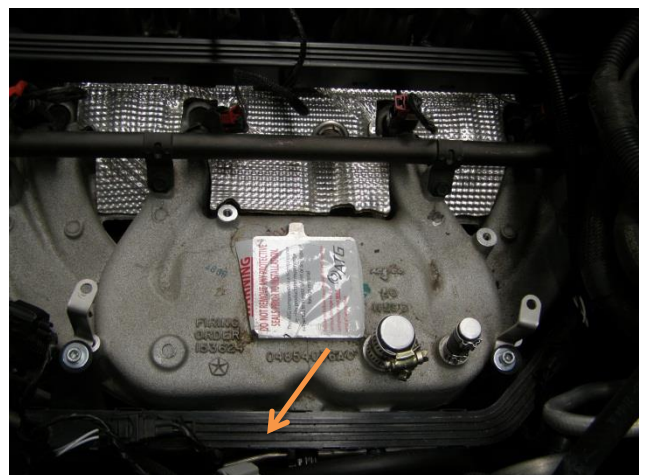



## JEEP- TJ (NON- INTERCOOLED) HARDWARE ONLY SUPERCHARGER SYSTEM

### 6. Remove adaptor with plug on the cable conduit and relocate

1. Remove the adaptor with plug from cable conduit and relocate as per the pictures given to clear the bottom side of the Supercharger discharge duct. Use cable tie to hold the adaptor with the conduit.

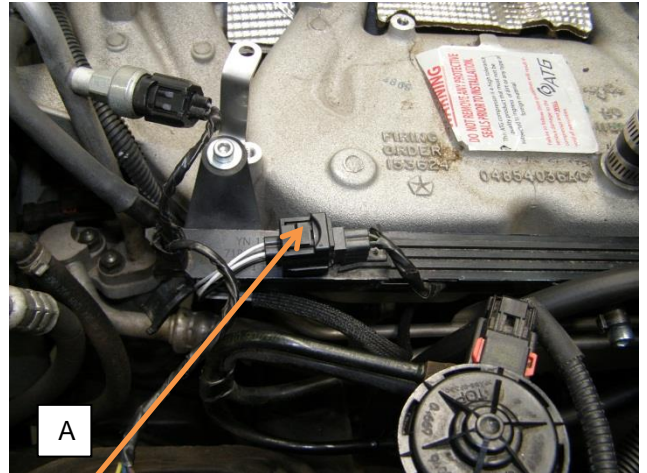

A

Remove adaptor and plug



B

Relocate adaptor and plug

## **7. Fit discharge assembly to the manifold**

1. Remove sealing tape from the bottom surface of the discharge manifold.
2. Apply rubber grease to O-Ring and fit it into the groove.
3. Clean the mounting surfaces on the vehicle manifold and carefully place the discharge assembly on top of the manifold as shown in the pictures.
4. Ensure that the assembly clears all hoses, cables, fuel rail and wirings.
5. Tighten the assembly with the provided SHCS M6 x 80 (torque to 11Nm / 8ft-lb)

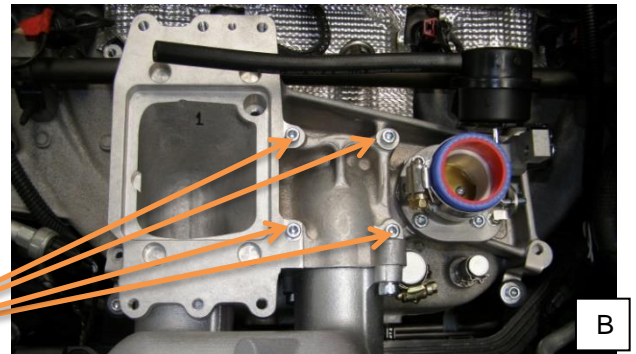

Tighten screws

6. Mount the cable conduit with steel brackets (2x) to the discharge manifold and tighten using two M6 x 50 SHCS supplied (torque to 11Nm / 8ft-lb).

**NOTE:** Ensure that the cable conduit clears manifold, discharge manifold and discharge ducts.



Tighten screws

## JEEP- TJ (NON- INTERCOOLED) HARDWARE ONLY SUPERCHARGER SYSTEM

7. Use other two M6 x 50 SHCS supplied and tighten the discharge manifold (torque to 11Nm / 8ft-lb).

Tighten screws

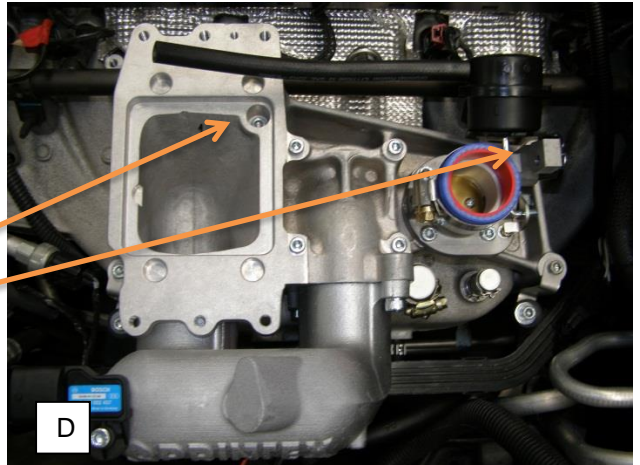

### 8. Bend the rear air-conditioner pipe (L/H drive vehicles only)

1. Using rubber mallet, carefully tap the rear air-conditioner pipe on top allowing it to lower by minimum 12mm from the original position.

Bend the pipe down



**NOTE:** Ensure that air-conditioner pipe is not damaged while trying to bend and also take special care to avoid the gas leak through the pipes and mountings.

**NOTE:** Ensure that the rear air-conditioner pipe clears the supercharger assembly.

Ensure clearance

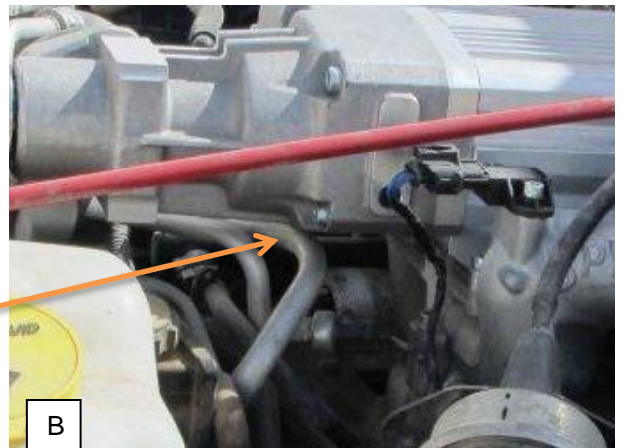

## **9. Fit Supercharger assembly to the discharge assembly**

1. Remove sealing tape from the discharge outlet of Supercharger
2. Apply a thin layer of rubber grease to the supplied O-ring (BS244 – 4 1/4"ID x 1/8"CS) and fit into the groove on the spigot on the supercharger clamp plate.
3. Fit the supercharger assembly (as supplied in the kit) into the discharge assembly and clamp them using six M8 x 25mm SHCS screws (torque to 23Nm / 17ft-lb).
4. Locate the spigots in the supercharger clamp plate and the intake housing carefully to avoid damage to the O-Ring and bypass hose.

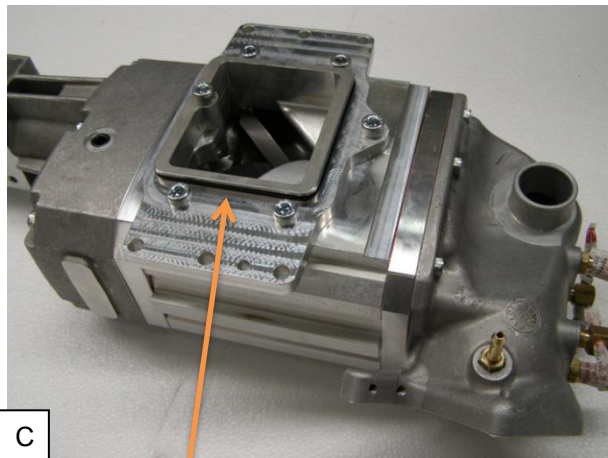
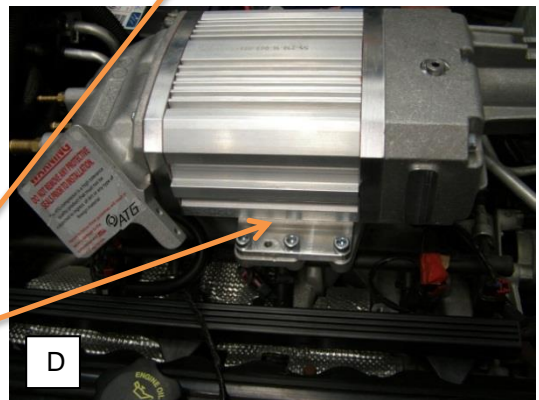
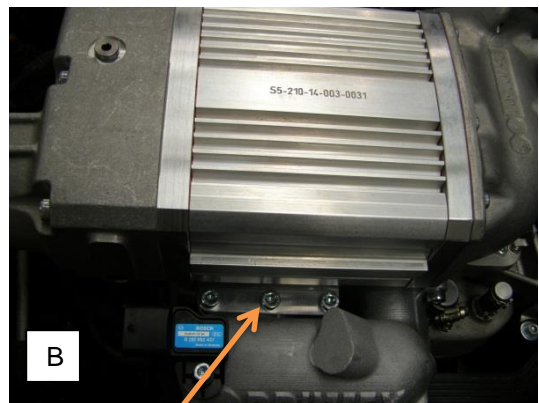
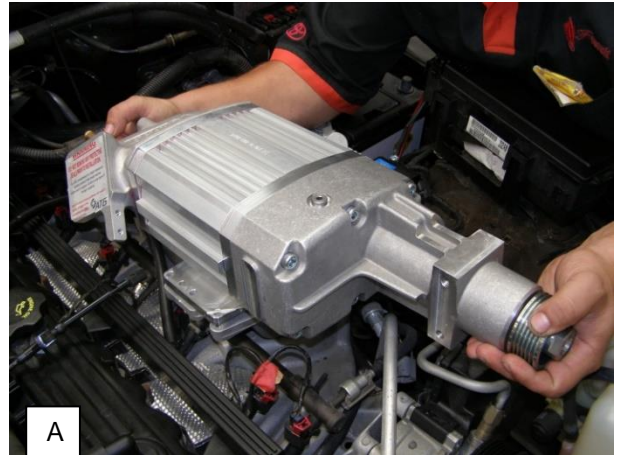

O-Ring

Tighten screws (6x)

## JEEP- TJ (NON- INTERCOOLED) HARDWARE ONLY SUPERCHARGER SYSTEM

5. Tighten the top hose clamp for the bypass hose.

**NOTE:** Ensure orientation of the hose clamp to avoid interference with bypass actuator lever during operation.

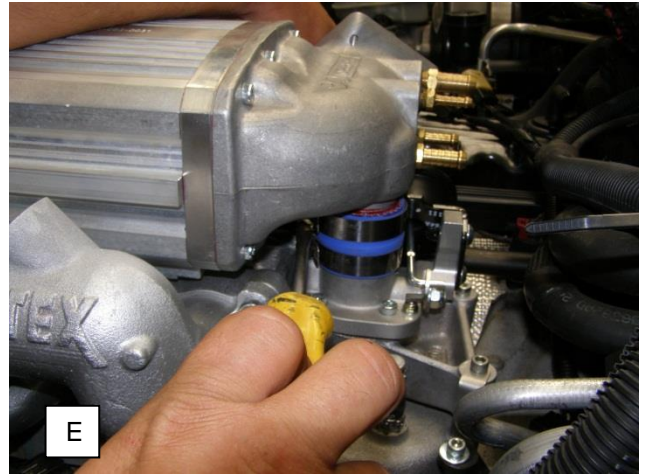

6. Connect the bypass actuator hose to the hose fitting in the intake housing.



### 10. Fit Idler pulley bracket & power steering pump

1. Fit the idler bracket assembly using two M8 x 30 SHCS and flat washers provided.
2. Use the previously removed standard two M8 Hex head screws to mount the power steering pump and the idler pulley bracket as shown in the picture.

**NOTE:** Tighten all screws uniformly (torque to 23Nm / 17ft-lb).

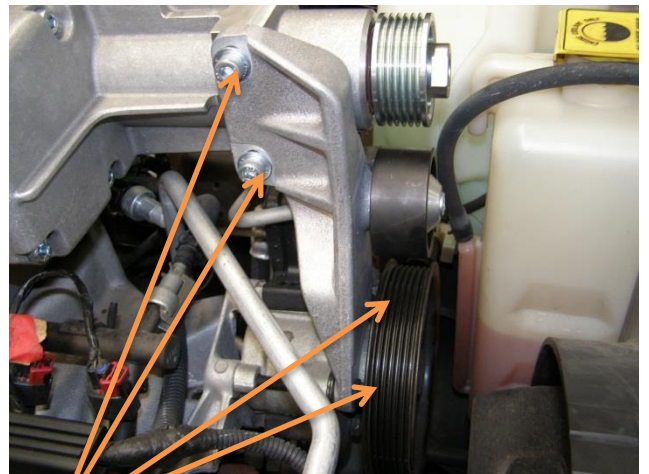

Tighten screws uniformly

## **11. Fit new throttle cable bracket**

1. Fit new throttle cable bracket supplied, using previously removed standard M6 Hex head screws (2x) into the intake housing (torque to 11Nm / 8ft-lb).
2. Tighten other side of the bracket using M6 x 25 SHCS (supplied) with the manifold (torque to 11Nm / 8ft-lb).



Tighten using factory  
M6 Hex head screws

Tighten using M6 x 25 SHCS

## 12. Fit throttle body

1. Connect TPS & IAC wiring plugs to the throttle body.
2. Fit the standard throttle body with the **factory gasket** using the previously removed factory M6 screws (4x). Torque to 11Nm / 8ft-lb.
3. Connect the throttle cable.
4. Connect the cruise control cable (if equipped) and kick down cable (if equipped).

**NOTE:** Check for free play of throttle cables.

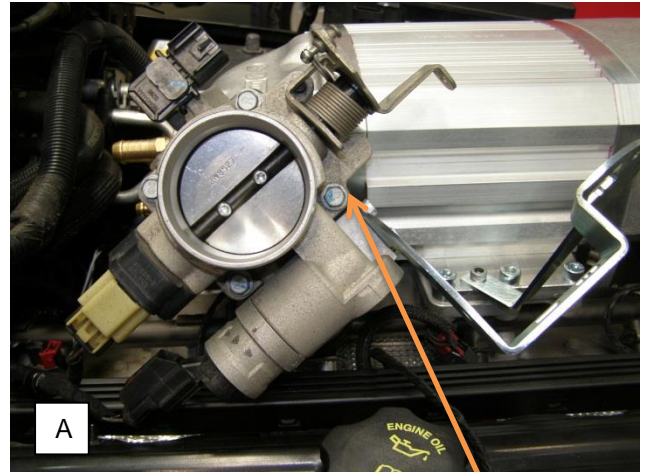

Tighten using factory  
M6 Hex head screws (4x)

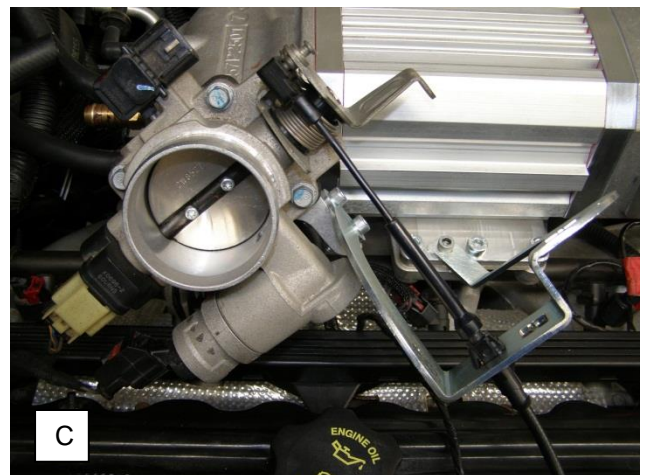

### 13. Glue bayonet adaptor to the new air inlet pipe

1. Apply Loctite 406 on the flat surface of the bayonet adaptor and attach it to the new air inlet pipe as shown in the pictures. Ensure orientation.
2. For earlier model vehicles use the supplied blanking plug (grommet) instead of the bayonet adaptor, if necessary.





## **14. Fit new air inlet pipe**

1. Connect new air inlet pipe between throttle body and air box. Secure with the hose clamps (3x) supplied. Use a hose clamp from the standard factory air inlet pipe.

NOTE: Ensure the orientation of the air temp sensor hole as shown in the picture.

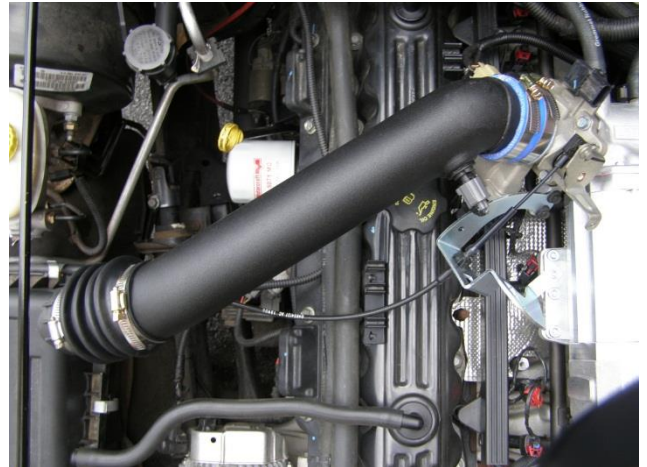

## **15. Fit the factory air temp sensor**

1. Fit the factory air temp sensor to new location on the air inlet pipe.
2. Connect the wiring plug back to the air temp sensor.



## JEEP- TJ (NON- INTERCOOLED) HARDWARE ONLY SUPERCHARGER SYSTEM

### 16. Hold the throttle cable in position

1. Hold the throttle cable in position with inlet pipe using a cable tie as shown in the picture.



### 17. Fit breather and vacuum lines

1. Connect the engine breather, brake booster hoses to the intake housing as shown in the picture.
  - a. Use new supplied hose for engine breather
  - b. Use the existing standard hose for brake booster

**NOTE:** If necessary, use the supplied brass T- fitting (optional part) for additional vacuum ports. Apply Loctite 577 to threads of hose fittings and blanking plugs upon assembly.

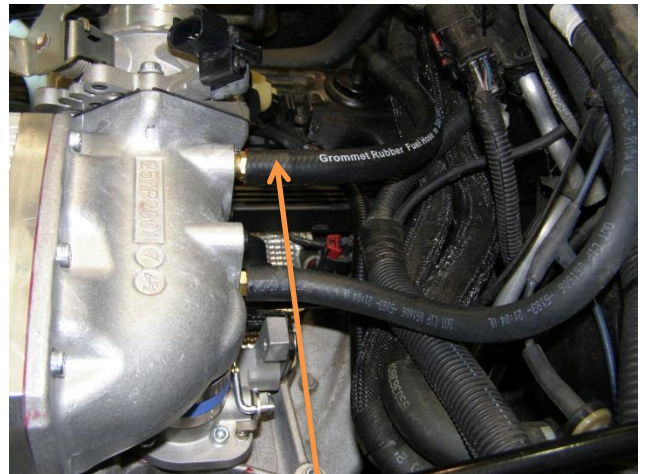

New breather hose

**18. Install Blanking plug for T-Map sensor (if supplied as loose items)**

1. Apply some rubber grease to the supplied BS109 O-ring.
2. Insert O-ring into the groove of the blanking plug.
3. Insert the plug into the orifice of the discharge outlet manifold and secure with the M6x16 socket head cap screw provided.
4. Tighten screw to 11Nm / 8ft-lb.

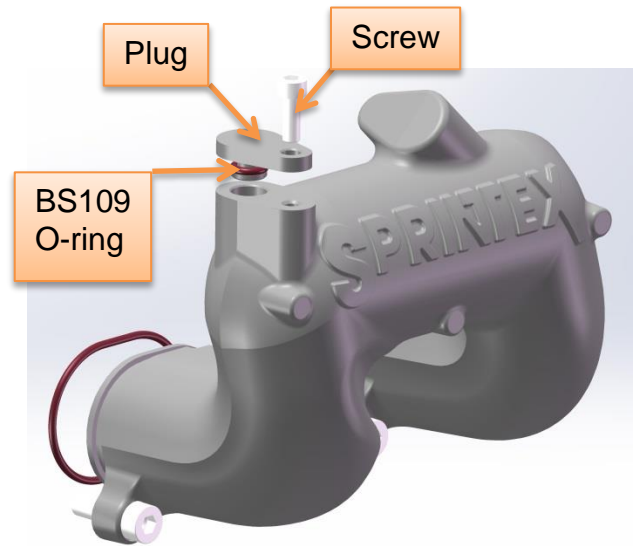

**19. Plug in electrical components**

Connect the miscellaneous wiring plugs.



**20. Fit new accessory drive belt**

1. Fit new accessory drive belt **6PK2530 (Gates No.K060997)** as per the belt routing diagram leaving the idler pulley as the last component for belt to be fitted over.
2. Use long series 1/2" breaker bar to release the dynamic tensioner.



**BELT ROUTING DIAGRAM (WITH A/C)**

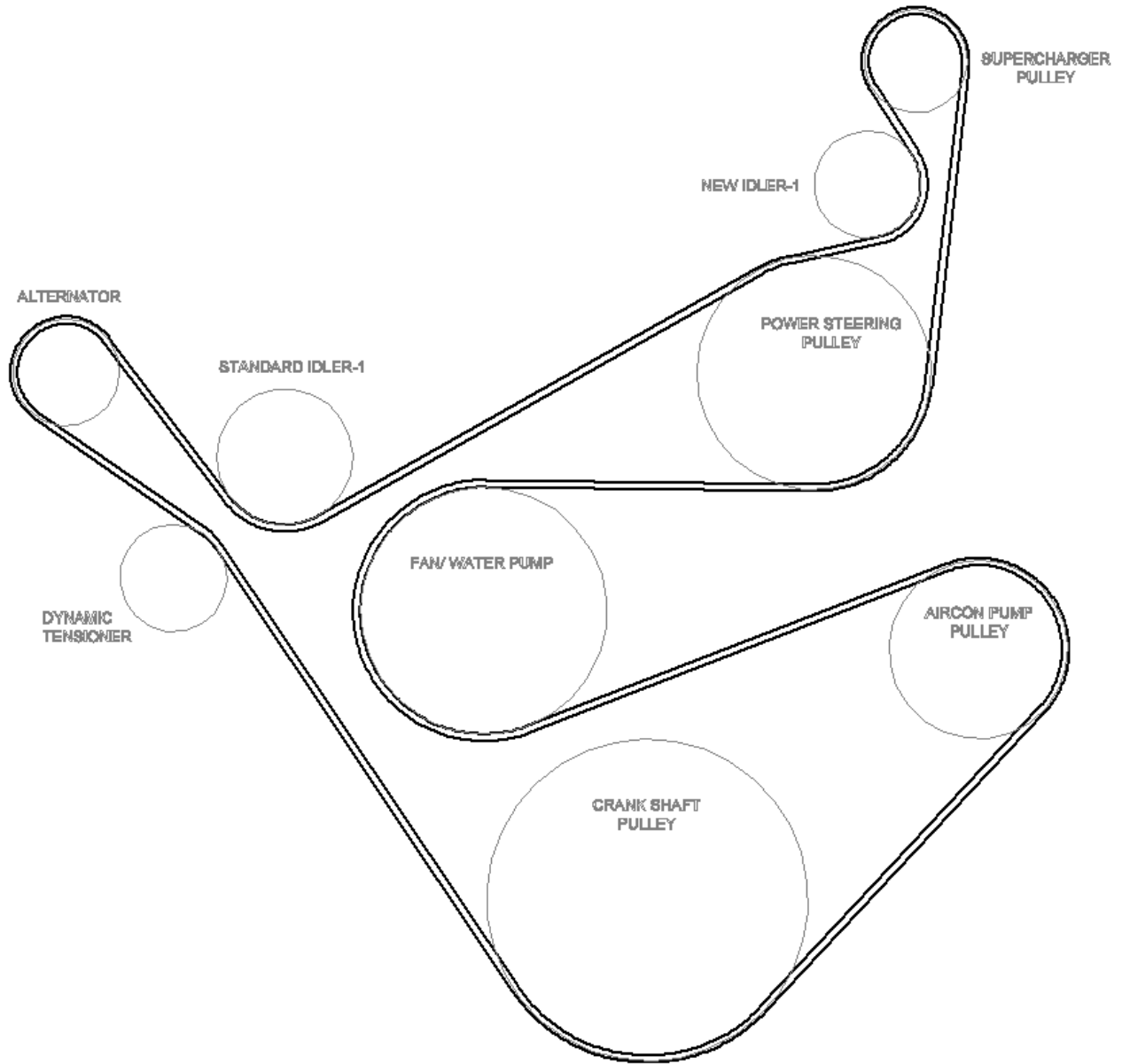

## JEEP- TJ (NON- INTERCOOLED) HARDWARE ONLY SUPERCHARGER SYSTEM

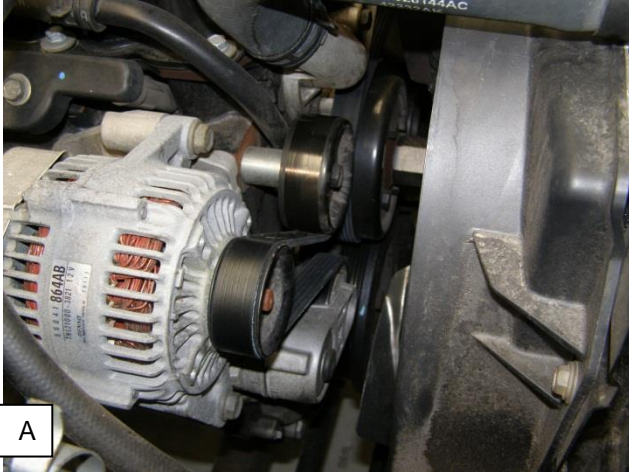

### 21. Reconnect battery

**NOTE:** Battery Positive terminal should always be connected first.



## **22. Install Premium unleaded fuel sticker**

- It is recommended that the Premium unleaded fuel sticker is installed inside of the fuel flap or close to the fuel cap in a visible convenient location.
- Clean the area with soap and water, rubbing alcohol or any other fast drying cleaner.
- Remove sticker from its plastic bag and peel sticker off front protective film and paper backing.
- Place sticker.

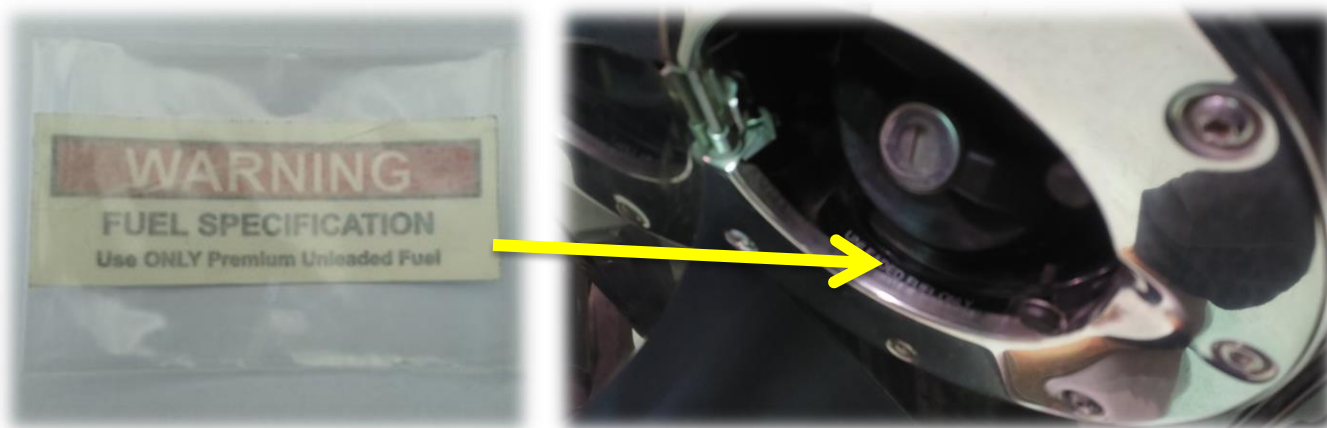

**JEEP- TJ HARDWARE ONLY SUPERCHARGER SYSTEM  
(NON- INTERCOOLED)**

**SECTION 3**

**PRE TEST-DRIVE INSPECTION**

## **Pre-Start Inspection**

- Ensure coolant is at correct level.
- Ensure engine oil is at correct level.
- Ensure vehicle has fresh 95 RON (91 Octane USA) Premium Unleaded fuel.
- Ensure the belt is aligned.
- Ensure the air filter is clean.
- Check & replace spark plugs, if necessary. Set gap to factory spec. 0.035”.

**SAFETY WARNING:** Ensure adequate steps are taken to prevent injury, spillage or fire should any of the required installation steps not have been carried out to specification.

## **Engine Warm Up**

Start engine and allow to run, until engine reaches normal operating temperature.

Check for oil leaks.

## **Road Test Vehicle**

Road test vehicle.

Recheck all joints and connections for leaks –rectify as needed.



---

# **JEEP- TJ HARDWARE ONLY SUPERCHARGER SYSTEM** **(NON- INTERCOOLED)**

## **SECTION 4**

### **MAINTENANCE INSTRUCTIONS**

## 1. Supercharger Drive Belt Replacement

It is recommended that the supercharger drive belt be checked at every regular service and be replaced at 50,000 km (30,000 miles) or 2 years, whichever occurs first.

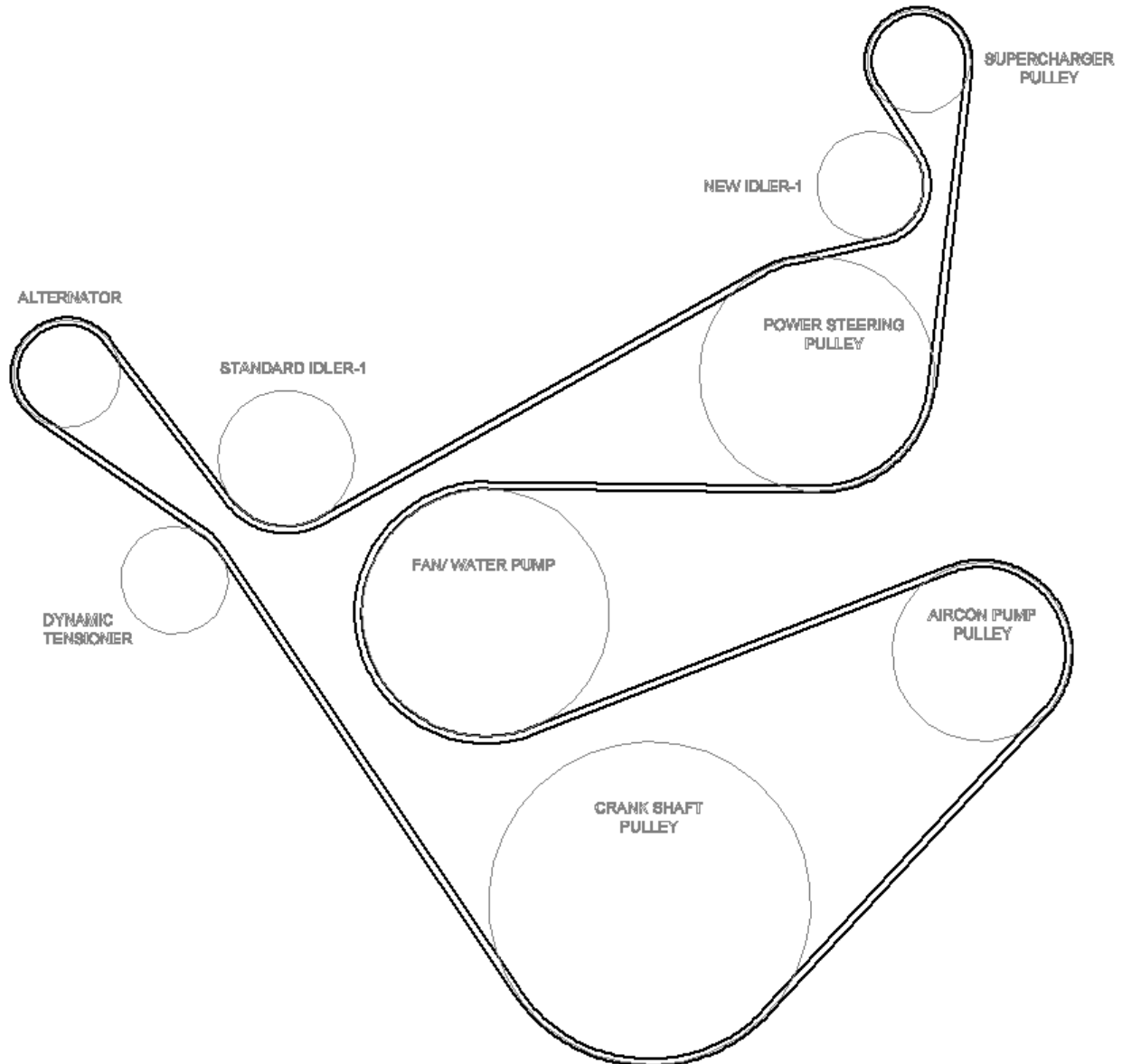

Use long series ½” breaker bar to release the dynamic tensioner and remove the belt.



## **2. Supercharger Removal**

**Refer to section 1**

DISASSEMBLY INTRUCTIONS, Pages 11 to 19.

### 3. Supercharger Lubrication Service

1. Drain and replace oil every 40,000 km (25,000 miles) or 2 years (whichever is earlier).
2. Place a suitable funnel under drain plug at front side bottom of Supercharger extension housing. Remove dip stick on top centre of cover to allow complete draining. Remove bottom plug and drain.
3. Fit the bottom drain plug back. Use Loctite 577 to threads upon assembly.
4. Supercharger is supplied with Redline 75W90 NS gear oil.

Fill with **157 millilitres or 5.31 US fluid ounces** of **Fully synthetic SAE 75W90 gear oil** (Specifications: API GL5, MT-1).

5. Fit the dip stick back on top of the supercharger extension housing (torque to 10Nm / 7ft-lb).

#### NOTES:

1. Check oil level with the dipstick provided in the Supercharger assembly. Tighten dipstick fully and then check the oil level.
2. Oil level should be checked with the dipstick periodically (Recommended every week and also before & after a long journey).

### 4. Spark plugs

Replace spark plugs every 50,000 km.

