



Installation Instructions Cable Bikini Top

Vehicle Application:
Jeep® Wrangler JL 2018-Current
Part Number 52607

Installation Tips

Before you begin installing your new Cable Bikini Top, please read all the instructions thoroughly.









WARNING Do not rely in any way on the components of this product to protect against injury or death in the event of an accident. Never operate the vehicle in excess of manufacturer’s specifications.

Read and follow, precisely, all installation instructions provided when installing this product. Failure to do so may result in a poor fit and could place occupants of the vehicle in a potentially dangerous situation.



WEAR SEAT BELTS AT ALL TIMES

CAUTION Safety glasses should be worn at all times when installing this product.

Tools		Installation Time	Support
 Safety Glasses	 T25 - T40 - T50 Torx Drivers	 30 minutes	We're here to help! Go to: https://www.bestop.com and click on Need Help?
 Ratchet	 13mm Socket	Skill Level	
- OR -	 13mm Wrench	 1 - Easy	
			https://www.bestop.com/video-library



Installation Instructions Cable Bikini Top

Vehicle Application:
Jeep® Wrangler JL 2018-Current
Part Number 52607

Sugerencias de Instalación

Antes de empezar a instalar esta unidad, lea atentamente todas las instrucciones.

Para un buen ajuste:

Para facilitar la instalación, el producto debe instalarse a temperaturas superiores a 72 °F (22 °C).

Por debajo de esta temperatura, la tela puede encogerse una pulgada o más, lo que dificultaría su ajuste al vehículo.

Es normal que la tela se contraiga o arrugue cuando está guardada en la caja de empaque. A los pocos días después de la instalación, la tela se relajará y las arrugas desaparecerán.



ADVERTENCIA

Este producto se diseñó principalmente para mejorar la apariencia del vehículo y proteger a los ocupantes de las condiciones climáticas comunes. De ninguna manera piense que los componentes de este producto pueden servir como medio de contención para los ocupantes del vehículo o que pueden protegerlos contra lesiones o la muerte en caso de accidente. Este producto no protegerá a los ocupantes contra caídas de objetos. Nunca conduzca este vehículo fuera de las especificaciones del fabricante.

USE LOS CINTURONES DE SEGURIDAD EN TODO MOMENTO

Lea y siga con precisión todas las instrucciones de instalación que se proporcionan para instalar este producto. Si no lo hace, podría producirse un mal ajuste que colocaría a los ocupantes del vehículo en una situación potencialmente peligrosa.



PRECAUCIÓN

Debe usar gafas protectoras en todo momento durante la instalación de este producto.

Conseils pour l'installation

Lire toutes les instructions au complet avant de commencer l'installation de cet assemblage.

Pour un ajustement sans problème :

Afin de faciliter l'installation, ce produit doit être installé à des températures au-dessus de 72 °F (22 °C).

Sous cette température, le tissu peut rétrécir d'un pouce (2,5 cm) ou plus, ce qui rendra l'ajustement sur le véhicule difficile.

Il est normal que le tissu rétrécisse et plisse pendant qu'il est dans la boîte d'expédition. En quelques jours après l'installation, le tissu se détendra et les plis disparaîtront.



AVERTISSEMENT

Ce produit est conçu principalement pour améliorer l'apparence du véhicule et pour protéger les occupants des conditions météorologiques usuelles. Ne jamais se fier aux composants de ce produit pour se protéger de blessures ou de la mort en cas d'accident. Ce produit ne protégera pas les occupants des chutes d'objets. Ne jamais utiliser le véhicule au-delà des caractéristiques techniques indiquées par le fabricant.

PORTER UNE CEINTURE DE SÉCURITÉ EN TOUT TEMPS

Lire et suivre, très fidèlement, toutes les instructions d'installation fournies lors de l'installation de ce produit. Ne pas suivre cette consigne peut causer une installation inadéquate et mettre les occupants du véhicule dans une situation potentiellement dangereuse.



MISE EN GARDE

Des lunettes de sécurité doivent être portées en tout temps lors de l'installation de ce produit.







Installation Instructions Cable Bikini Top

Vehicle Application:
Jeep® Wrangler JL 2018-Current
Part Number 52607

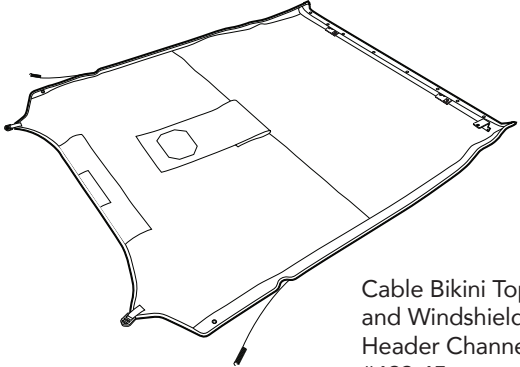
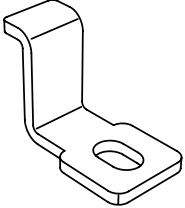
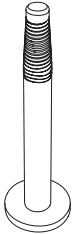
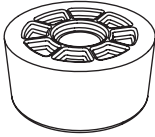
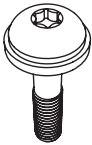
Parts List

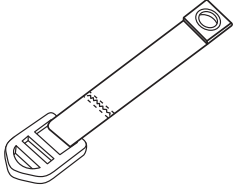
- Required parts for installation - Page number in Installation Guide

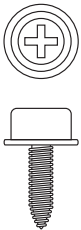
Sections 1 to 2		Bikini Top/Header Channel, Latch Receiver Bracket & Fasteners			Pages 4 to 5 of Guide				
	Cable Bikini Top and Windshield Header Channel #423.45		Latch Receiver Z-Bracket Part #596.45 Qty. 2		M8 x 1.25 X 80mm Button Head Socket Cap Screw/Washer Part #532.23 Qty. 2		Bolt Spacer Bezel Part #574.05 Qty. 2		M8x1.25x38 Button Head Socket Cap Screw/Washer Part #532.17 Qty. 2
Sections 3 to 6		Fasteners, Straps, Tail Clips			Pages 6 to 9 of Guide				
	M8 Nylon Lock Nut #434.12 Qty. 2		Buckle Straps Qty. 2		Snap Straps Part # 600.64 - 26" Qty. 4		Tail Clip Part #338.24 Qty. 4		Snap Stud Screw #8x5/8" Part #728221 Qty. 6

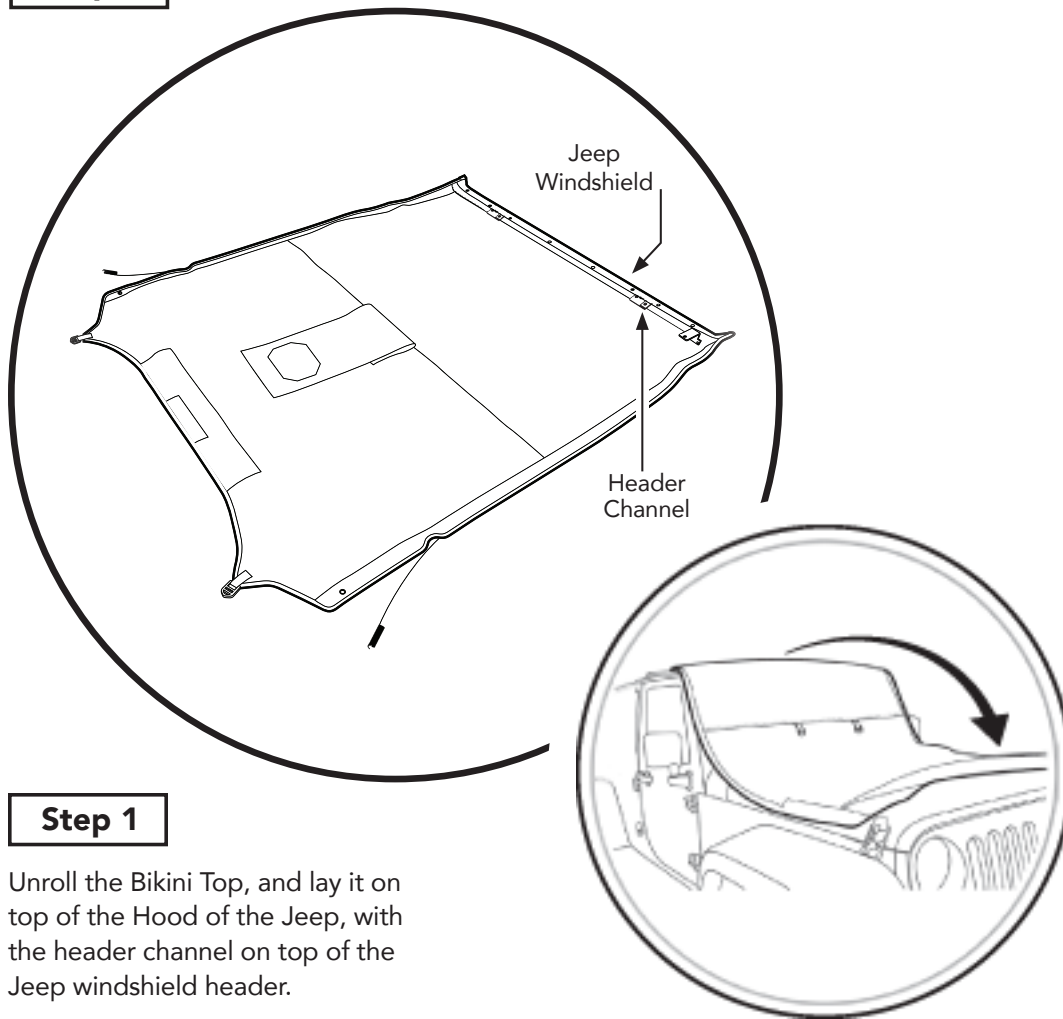
Step 1**Step 1**

Unroll the Bikini Top, and lay it on top of the Hood of the Jeep, with the header channel on top of the Jeep windshield header.

Step 1	423.45	532.23	596.45	574.05
---------------	--------	--------	--------	--------

Hardware

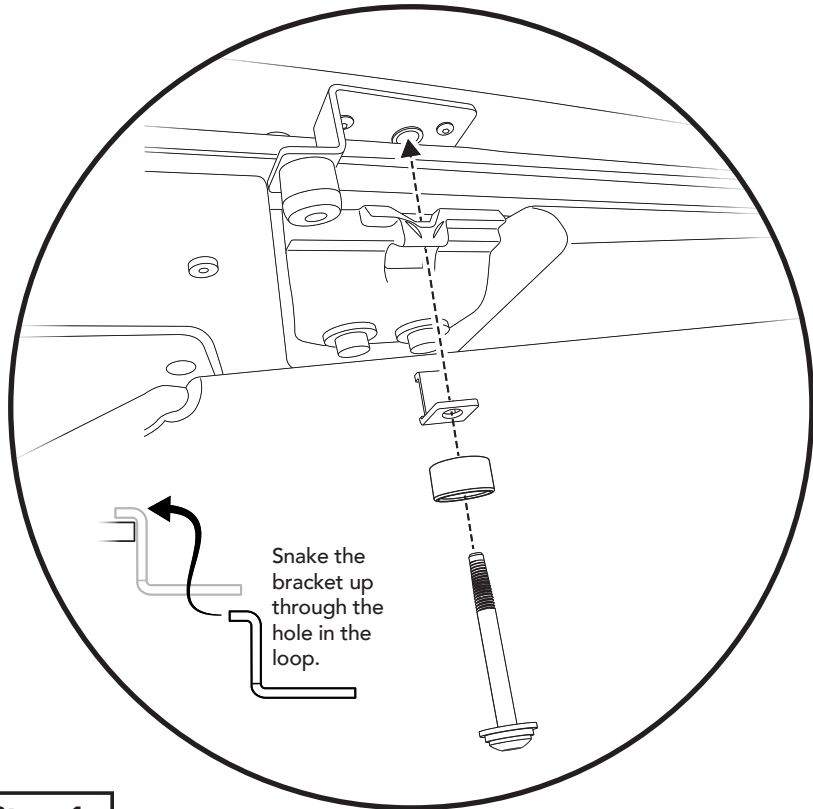

Windshield Header Channel
Part #423.45
With Bikini Top attached
(Bikini not shown)

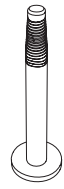

M8 x 1.25 X 80mm
Button Head
Socket Cap
Screw/Washer
Part #532.23
Qty. 2

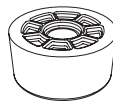

Bolt Spacer Bezel
Part #574.05
Qty. 2

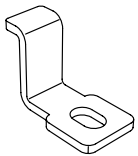

Latch Receiver Z-Bracket
Part #596.45
Qty. 2

Tools



T40 Torx
Driver

Step 1

Secure the Bikini Windshield Header Channel #423.45 to the Jeep windshield header, using one (1) Latch Receiver Bracket #596.45, one (1) M8x1.25x80mm Button Head Socket Cap Screw/Washer #532.23, and one Bolt Spacer Bezel #574.05 per side.

The Latch Receiver Bracket and the M8x1.25x80mm long Screw/Washer with additional M8 washer and Spacer Bezel are attached from the underside to secure the Latch Receiver Bracket to the windshield header.

The Latch Receiver Bracket must be snaked up through the hole in the windshield header latch loop, so that the lip at the top of the bracket catches the horizontal edge on the header.

Do not tighten this fastener until after installing the Button Head Socket Screw #532.17 in Section 3 Step 1 (on the following page).

Step 1

532.17

434.12

Hardware

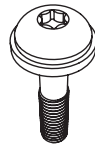

M8x1.25x38
Button Head
Socket Cap
Screw/Washer
Part #532.17
Qty. 2



M8 Nylon Lock Nut
#434.12
Qty. 2

Tools



13mm Wrench



T50 Torx
Driver

Step 3

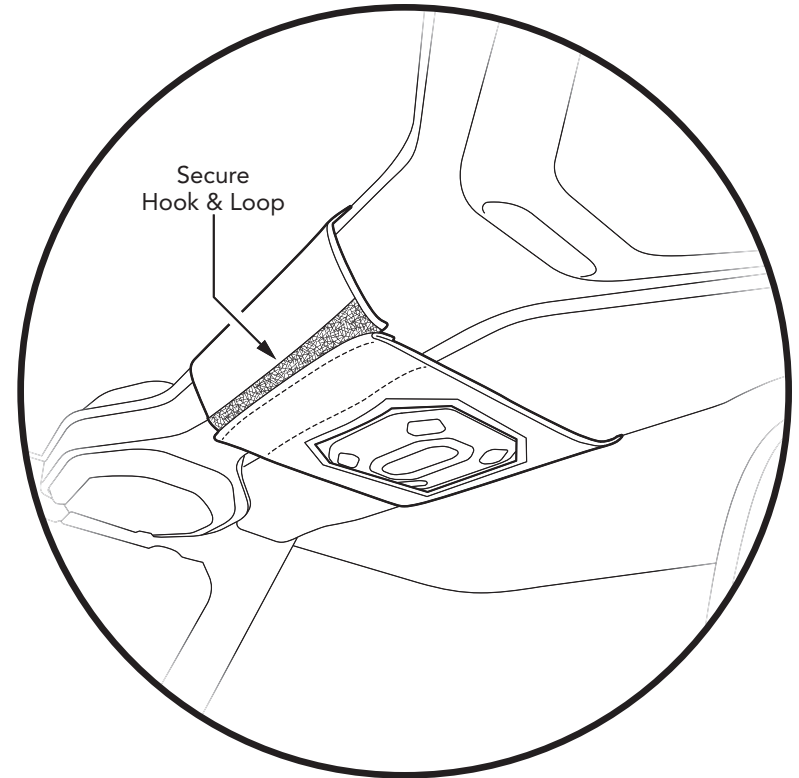
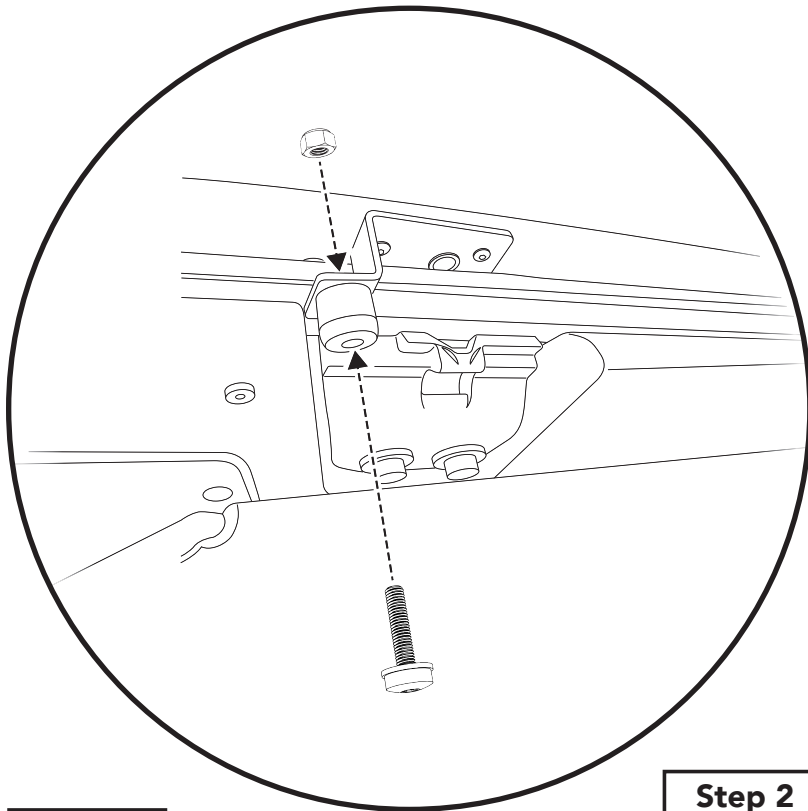

Step 1

Attach the M8x1.25x38 Button Head Socket Cap Screws #532.17 from the underside, and secure the pre-attached brackets on the Header Channel to the windshield header, using one (1) M8 Nylon Lock Nut #434.12 on top of each pre-attached bracket.

Step 2

Lay the fabric top back across the Jeep, over the soundbar and sportbar.

Step 2

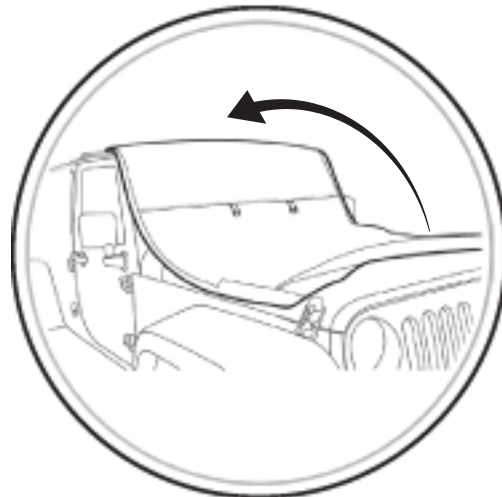

Step 3

Wrap the Soundbar Flap around the soundbar, and secure using the Hook & Loop strip.

Make sure that all lights on the underside of the soundbar are exposed.

Step 1 Buckle Straps

Hardware

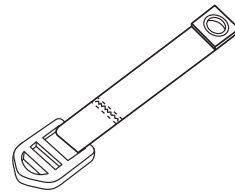
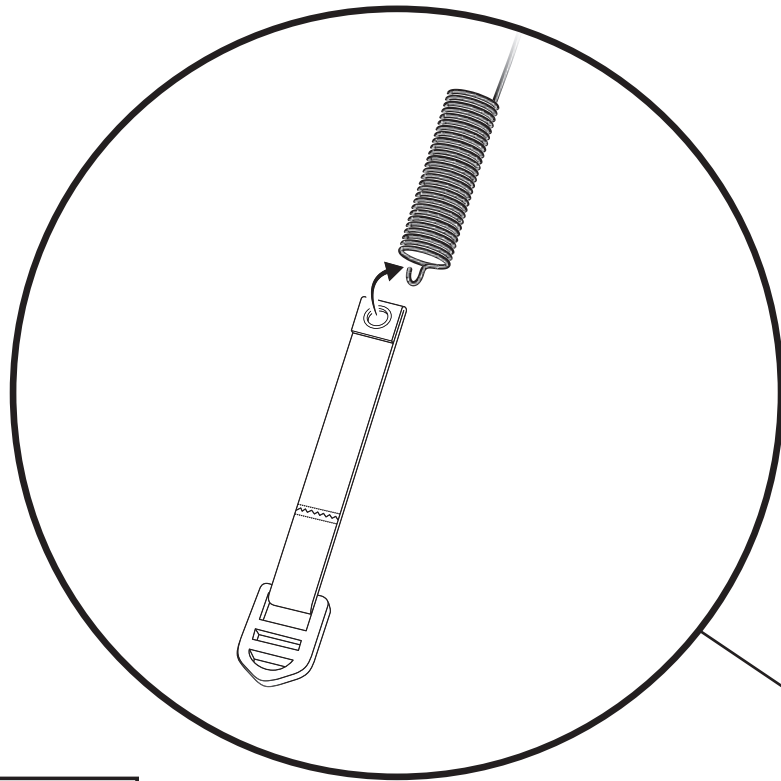

Buckle Straps
Qty. 2

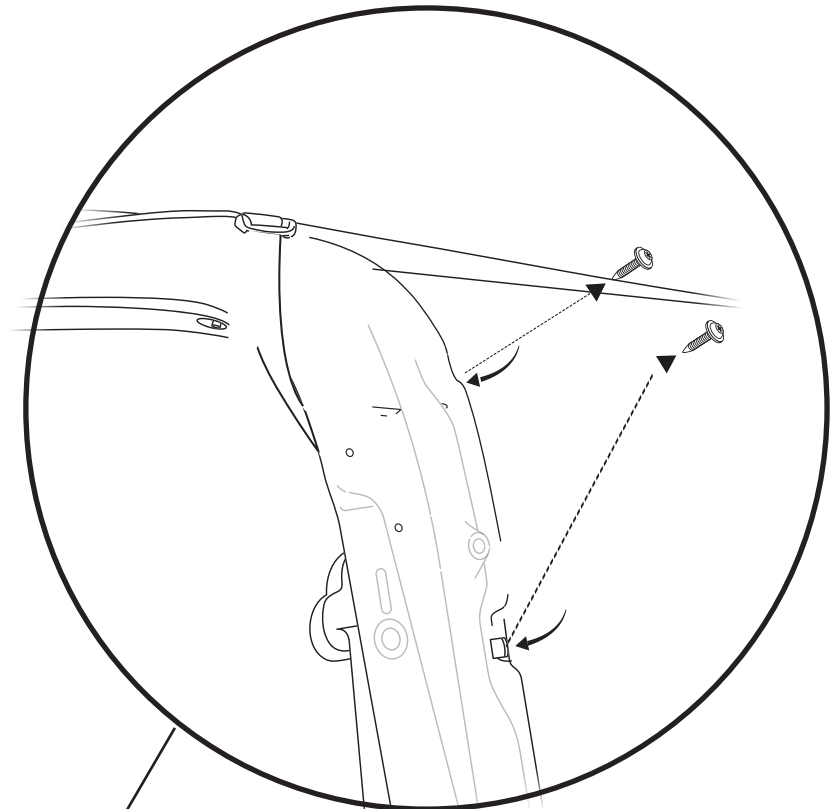

Step 1

Locate the spring on the end of each cable, where it exits the fabric top near the middle of the rear sport bar.

Attach the grommet end of each Buckle Strap to the end of the spring.

Step 2

1 Remove Trim Screws and replace with the 728221 Snap Screws in both places. Attach the Snap Straps to the Snap Screws in both places. Slip the Grommet Strap into the buckle on the end of the Grommet Strap that you attached to the Cable Spring in Section 4 Step 1.

2 Run the Snap Strap along the outside of the Sport Bar, wrap the strap around the outside of the Sport Bar, and snap to the upper snap on



Step 1 Snap Straps

Hardware

Step 2 Snap Straps

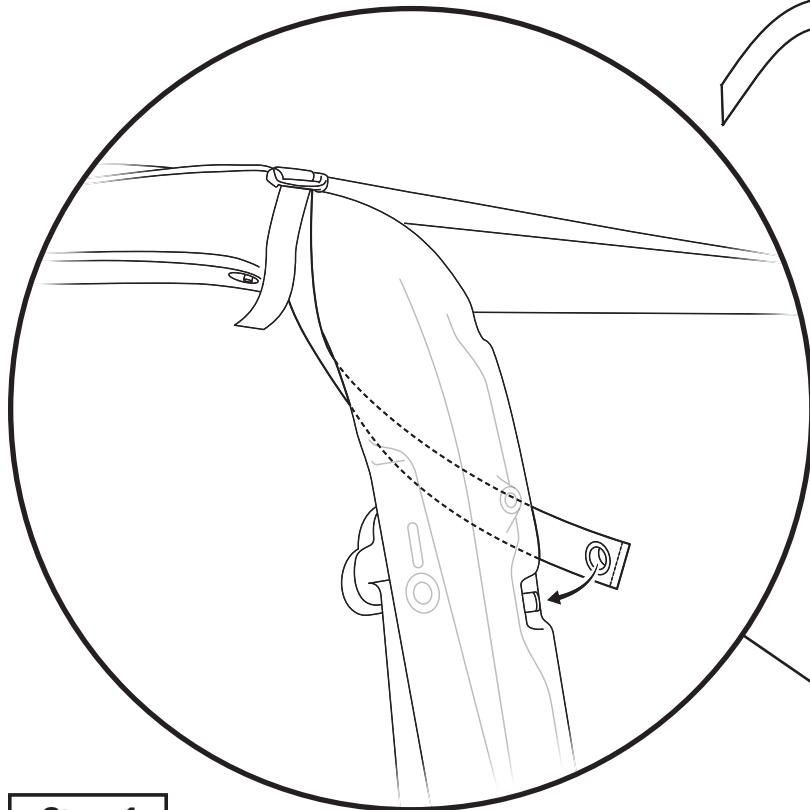

Snap Straps
Part # 591.20 - 21"
Qty. 2
Part # 600.64 - 26"
Qty. 2



Snap Stud Screw
#8x5/8"
Part #728221
Qty. 4

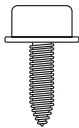

Tools



T25 Torx Driver
Phillips Screw

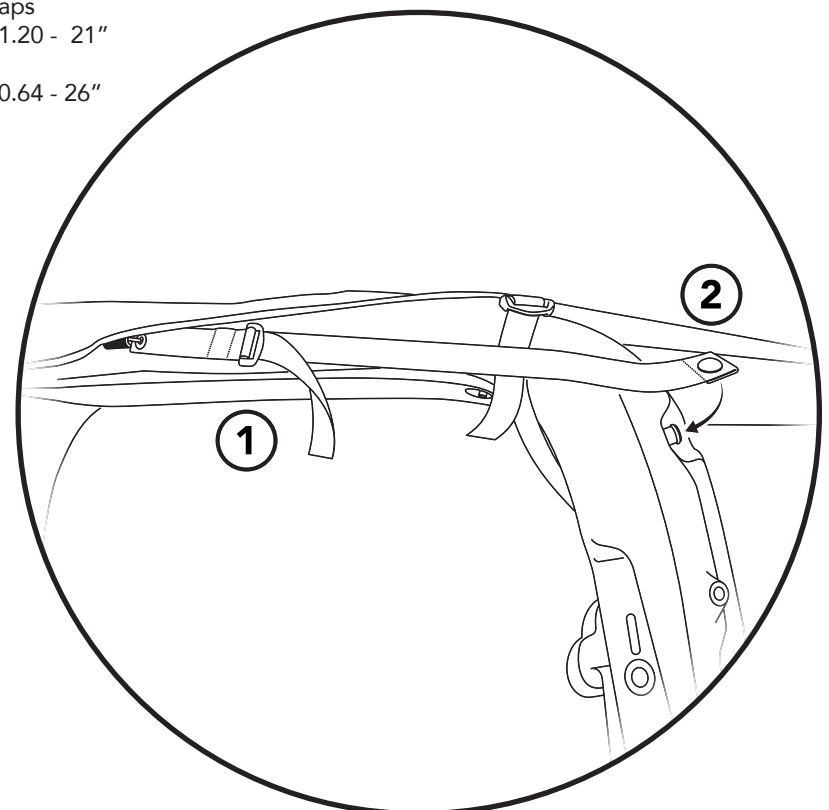

Step 1

Attach a Snap Strap to the buckle on each rear corner of the top.

Wrap the strap around the outside of the Sport Bar, and then under the Sport Bar, and snap to the middle snap on the interior side of the Sport Bar.



Step 2

- ① Attach a Snap Strap to the buckle on the end of the Grommet Strap that you attached to the Cable Spring in Section 4 Step 1.
- ② Run the Snap Strap along the outside of the Sport Bar, wrap the strap around the outside of the Sport Bar, and snap to the upper snap on the interior side of the Sport Bar.

Step 1 338.24

Hardware



Tail Clip
Part #338.24
Qty. 4

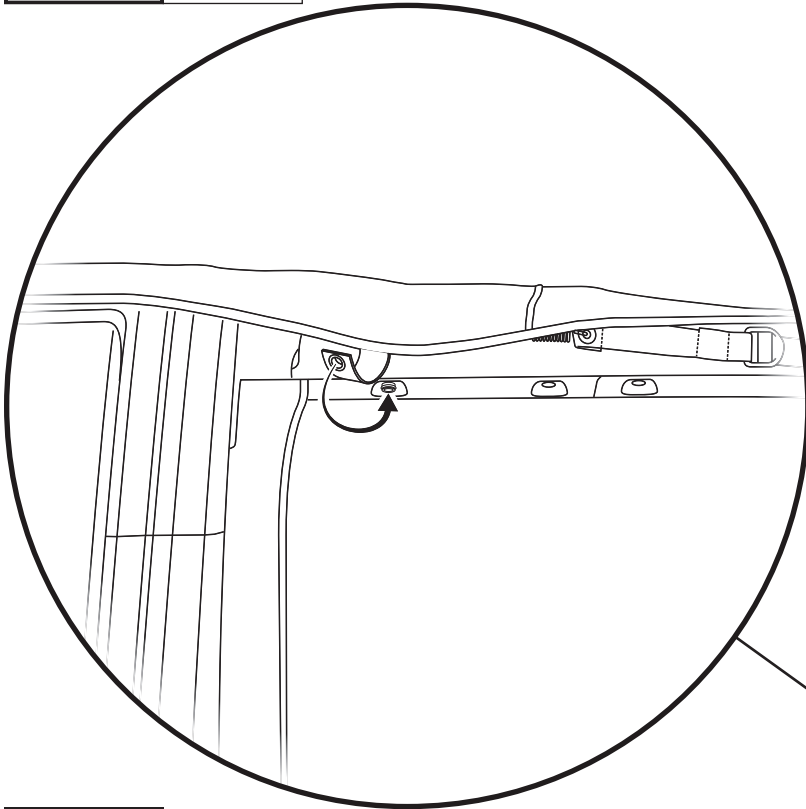

Step 1

Remove the Screws from the Sports Bar, attach the Grommet Strap and Screw to the underside of the Sport Bar just behind the door.

Repeat on both sides of the Jeep.





Warranty Information Cable Bikini Top

Vehicle Application:
Jeep® Wrangler JL 2018-Current
Part Number 52607

WHAT BESTOP WARRANTS

Subject to the terms and conditions of sale, including any terms and conditions set forth by Bestop, Inc. (“Bestop” or “us” or “we”) in our then-current terms of sale on our website (collectively, the “Terms”), Bestop represents and warrants that: the covered products listed in the “Covered Products and Warranty Periods” section (a “Product”) will substantially be free from defects in materials and workmanship for the specified warranty periods set forth in that section.

THE WARRANTY IS LIMITED AND CONDITIONAL

This warranty applies to the original purchaser of the Product only. The warranty is valid only as long as the original retail purchaser owns the vehicle upon which the Product is installed. The warranty expires should the Product be removed from the original vehicle or if the original vehicle is transferred to another owner.

This warranty is not transferable or assignable. The warranty does not apply to Product bought from auction-style or price-bid websites.

THE LIMITED WARRANTY AND STATED REMEDIES ARE SOLE AND EXCLUSIVE AND IN LIEU OF ALL OTHER WARRANTIES AND REMEDIES, AND COMPANY EXPRESSLY DISCLAIMS ALL IMPLIED OR STATUTORY OR OTHER WARRANTIES, INCLUDING WITHOUT LIMITATIONS WARRANTIES OF MERCHANTABILITY, NON-INFRINGEMENT OR FITNESS FOR A PARTICULAR PURPOSE. IN NO EVENT WILL COMPANY BE LIABLE FOR ANY SPECIAL, INCIDENTAL, CONSEQUENTIAL, PUNITIVE, INDIRECT OR EXEMPLARY DAMAGES OF ANY KIND, INCLUDING LOST PROFITS OR REVENUE, HOWEVER CAUSED, WHETHER FOR BREACH OR REPUDIATION OF CONTRACT, TORT, BREACH OF WARRANTY, NEGLIGENCE, OR OTHERWISE, WHETHER OR NOT COMPANY WAS ADVISED OF THE POSSIBILITY OF SUCH LOSS OR DAMAGES.

Some states do not allow exclusion or limitation, so this may not apply to you. This warranty gives you specific legal rights, and you may have other rights which vary from state to state.

EXCLUSIONS TO THE WARRANTY

The Limited Warranty excludes, and Bestop is not liable in any way for any warranty claims, damages, or defects related to:

- Misuse, abuse, accidents, vandalism, negligence, fire, or improper installation or modification, or improper or inadequate maintenance;
- Failure to comply with any Product documentation, Bestop instructions, or applicable law or regulations; use in extreme conditions
- Force Majeure including but not limited to, earthquake, hurricane, tornado, flooding, or other disasters natural or man-made, civil unrest, strikes, declared or undeclared war, or lack of performance by, or discontinued product of, supply chain partners whose products, software, operations or management is beyond the control of Bestop;
- Damage resulting in breakage (including without limitation, spontaneous breakage, accidental breakage or breakage by any other means) of a Product or any component part;
- Damage to vinyl windows due to misuse, or cracking due to varying weather conditions.

YOUR SOLE REMEDY

During the applicable warranty period, Bestop shall, at its option, either repair or replace any Product that it confirms, in its discretion, is non-compliant with the warranties herein. Bestop will not pay for labor charges associated with installation or removal of the Product. Should a specific Product be discontinued, Bestop may, at its option, replace the discontinued Product with a current product or like product.

Please retain your proof of purchase. Original proof of purchase for the Product must accompany any warranty claim. If you have a warranty claim, first you must email Bestop Customer Service at csbestop@bestop.com for instructions. All claims must be emailed to csbestop@bestop.com within 30 days of discovery of a defective Product, but in no event later than thirty days after the end of the applicable Warranty Period (the “Warranty Notice Period”). Warranty claims made after the Warranty Notice Period are null and void and Bestop shall have no responsibility with respect to such claims.

THIS SECTION SETS FORTH BESTOP’S SOLE OBLIGATION & YOUR SOLE REMEDY WITH RESPECT TO ANY DEFECTS OR OTHER PRODUCT ISSUE. ANY PRODUCTS REPLACED UNDER TERMS OF THIS WARRANTY WILL BE COVERED UNDER TERMS & BALANCE OF THE DURATION OF THE ORIGINAL LIMITED WARRANTY FOR SUCH PRODUCT.



Warranty Information Cable Bikini Top

Vehicle Application:
Jeep® Wrangler JL 2018-Current
Part Number 52607

COVERED PRODUCTS AND WARRANTY PERIODS: The warranty time periods are as follows for Products manufactured by Bestop:

BESTOP® LIMITED LIFETIME WARRANTY

Trektop® Pro Twill Fabric Top Sunrider® for Hardtop Twill Fabric Top
Trektop® NX Glide Twill Fabric Top Replace-a-Top™ Twill Fabric Top
Trektop® NX Twill Fabric Top Supertop® NX Twill Fabric Top
EZFold™ Soft Tonneaus Floor & Cargo Liners
ZipRail™ Soft Tonneaus Pet Barriers
EZRoll™ Soft Tonneaus

BESTOP® 5-YEAR LIMITED WARRANTY

Trektop® NX Glide™ Top (non-Twill) Sunrider® for Hardtop (non-Twill) Replace-a-Top™ Top (non-Twill) Trektop® NX Top (non-Twill)
Sailcloth Replace-a-Top™ Supertop® NX Top (non-Twill)
Tigertop™ and Halftop™ Supertop® Classic Soft Top Sunrider® Complete Soft Top Supertop® for Truck
EZ Fold Hard Tonneau

BESTOP® 3-YEAR/100K MILES LIMITED WARRANTY

Powerboard® & Powerboard® NX
Trekstep®, Side Mount
Trekstep®, Rear Mount

BESTOP® 3-YEAR LIMITED WARRANTY

Pavement Ends Sprint Top

BESTOP® 2-YEAR LIMITED WARRANTY

Trektop® Classic Soft Top
RoughRider™ Soft Storage

BESTOP® 1-YEAR LIMITED WARRANTY

All other Bestop® & Pavement Ends™ products not specified above.

For further information or request for warranty work, please contact:

Bestop Inc. Customer Service
Toll-Free: (800)845-3567
Main: (303)465-1755
E-mail: csbestop@Bestop.com
Website: www.Bestop.com