

Save this manual for future reference. Read and understand all instructions and safety precautions before use.



 **WARNING**

Improper installation or use of your Roof Top Tent may result in serious injury or death. Follow these installation instructions carefully to ensure proper installation on your vehicle and for safe use of your Roof Top Tent. Please contact your vehicle manufacturer for specified loading capacity of your roof rack. Not all factory roof racks, or aftermarket roof bars can safely accommodate tent models.

ANY ELEMENTS APPLIED ON THE VEHICLE ROOF CHANGES THE NORMAL VEHICLE HANDLING. THE MANUFACTURER DISCLAIMS ANY AND ALL RESPONSIBILITY IN THE CASE OF ACCIDENTS DUE TO IMPROPER USE, INCORRECT MAINTENANCE, OR NOT CHECKING THE TIGHTNESS OF THE FASTENING HARDWARE/ BRACKETS ON THE ROOF RACK SYSTEM

DO NOT CLIMB ON LADDER UNTIL CORRECT ANGLE IS ACHIEVED (approx. 60 degrees between ladder and ground).

NOTE: If the angle of the ladder is at 90 degrees and/or does not reach the ground, you will need a ladder extension or longer extendable ladder (sold separately, contact your distributor).

The wholesaler / manufacturer shall not be liable for special, indirect, incidental, or consequential damages including but not limited to lost profits.



WARNING

KEEP ALL FLAME AND HEAT SOURCES AWAY FROM THIS TENT. This tent is not fireproof. The fabric will burn if left in continuous contact with a flame source.

PRECAUTIONS

Do NOT use candles, matches or other open flames in or near a tent. Fuel-powered lanterns and appliances are NOT recommended for use in or near a tent. If fuel-powered lanterns or appliances such as wood stoves or electric heaters are used, **exercise extreme caution**. Keep them away from the tent walls.

Do NOT leave them unattended. Turn them off before going to sleep. Make sure the tent is well always ventilated to avoid suffocation. Build campfires downwind and several meters away from a tent. Extinguish campfires before leaving a campsite or going to sleep.

Do NOT fuel lamps, heaters, or stoves in a tent.

Do NOT smoke in a tent.

Do NOT store flammable liquids in a tent. Keep exits clear.

Do NOT apply any foreign substance to a tent. It may diminish the flame-resistant properties of tent material(s).



SKY RIDGE - 20011

ROOFTOP TENT

INSTALLATION INSTRUCTIONS



VERIFY YOUR VEHICLE'S ROOF STRENGTH

This Roof Top Tent weighs 147 Lbs. tent capacity of 800lbs

Check your vehicle owner's manual or with the vehicle manufacturer to determine the vehicle's maximum effective roof load.

The maximum load on the roof of the vehicle must be observed. Determination of the effective roof load:
weight of the roof bars + weight of the Roof Top Tent = effective roof load.







DO NOT transport additional items inside, attached to, or on top of the Roof Top Tent.

INSPECTION

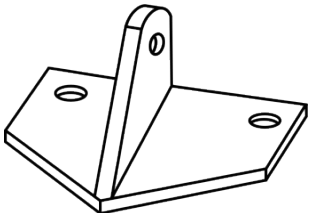
Prior to beginning any trip with the Roof Top Tent installed on your vehicle, ensure that all nuts and bolts that attach the Roof Top Tent are tight and in good repair.

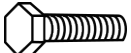
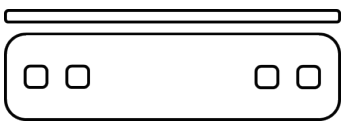
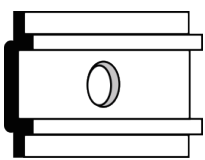
During the trip, regularly check that all fasteners continue to be tight and have not become loose.

ROOF TOP TENT HARDWARE IDENTIFICATION CHART

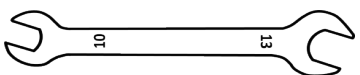
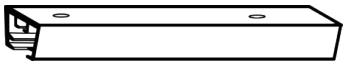
Item	Description	Qty	
1	Ladder Mounting Bracket	2	
2	55mm Stainless Steel M8 Bolt	8	
3	40mm Stainless Steel M6 Bolt	10	
4	16mm Stainless Steel M6 Bolt	2	
5	Stainless Steel Mounting Plate	4	
6	Aluminum Slide Plate	8	
7	Rubber Washer (for Ladder)	4	
8	M8 Self-Locking Nut	8	
9	M6 Self-Locking Nut	10	
10	Stainless Steel Washer	26	
11	Metric Wrench 10/13 mm	2	
12	Mounting Channel	2	

Attaching the Mounting Rails to the Roof Top Tent

Direction of Opening

Before you fit your Roof Top Tent to your vehicle, you will need to decide whether you wish to have the tent open to the back or to the side of the vehicle. Most will open the tent from the side whether it is driver or passenger.

A. Opening to the Back

- The mounting channels will need to be cut off at both ends prior to being fitted to the base of the rooftop tent.

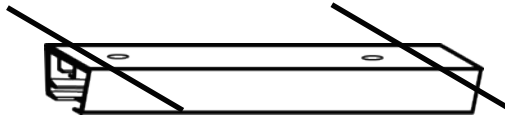

- The mounting channels are then bolted to the base of the tent at right angles to the roof rack or roof bars, in the direction of opening (along the length of the tent base).

B. Opening to the Side

- The mounting channels bolt to the base of the tent at right angles to the roof rack or roof bars (across the width of the tent base).



Opening to the side



SKY RIDGE - 20011

ROOFTOP TENT

INSTALLATION INSTRUCTIONS



Attach the Mounting Channels to the Base of the Roof Top Tent

(Numbers in parenthesis refer to the Roof top tent hardware identification chart)

1. Remove the Roof Top Tent from the carton and place it on a clean surface. Observe the top surface. If it has four holes in the center area of the base, then this is the channel mounting surface. Otherwise, you are viewing the side that will receive the ladder. Open the tent and remove the hardware from the inside.

The contents consist of the following items:

Ladder	1 pc
PVC Cover	1 pc
Window Rod	6 pc

Mounting Channel	2 pc
Mounting Accessories	1 bag

2. Close the Roof Top Tent so the channel mounting surface as described above is facing upward, then remove the plugs that are covering the holes.

3. Place a stainless-steel washer (Item 10) on each of four 40 mm Stainless Steel M6 Bolts (Item 3). Use your hand to slide between the base and the mattress and insert a bolt with washer into each hole so that the bolt head is inside the tent below the mattress.

4. Place the Mounting Channels (Item 12) onto the protruding bolt threads. As discussed previously, if your orientation is to be Opening to the Back, ensure the Mounting Channels are parallel to the tent hinge. (Note: when mounting the channels for Opening to the Back orientation, the channels will need to be trimmed. Mark

the channel ends and cut so it is flush with the base.) Otherwise, if your orientation is to be Opening to the Side, ensure the Mounting Channels are perpendicular to the tent hinge.

5. Individually slide an M6 Self-Locking Nut (Item 9) into the inner slot at the center of the Mounting Channel with the flat part of the nut towards the tent base. Align the nut with the protruding bolt thread and use the 10mm Metric Wrench (Item 11) to tighten firmly.

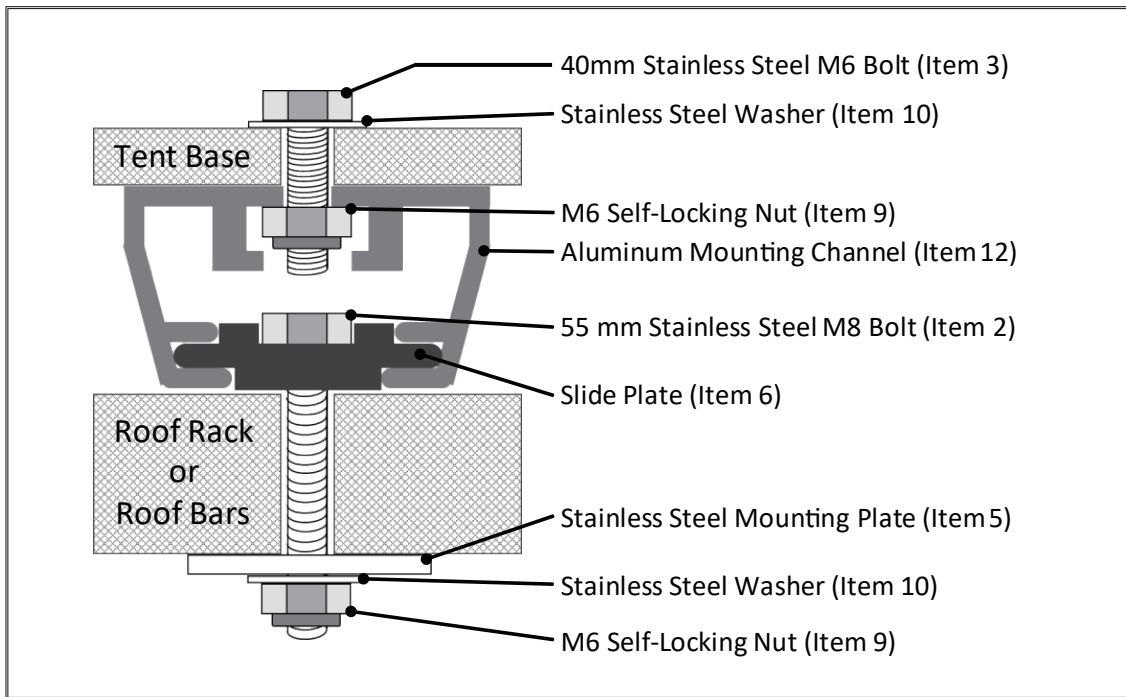

Mounting Diagram

Attach the Ladder to the Base of the Roof Top Tent

(Numbers in parenthesis refer to the Roof top tent hardware identification chart) C

1. Once the Mounting Channels have been installed, and with the tent folded, turn the tent over so the Mounting Channels are underneath, take care not to damage to the Mounting Channels.

2. Locate the pre-drilled holes at the edge of the base, opposite the hinge, and use four 40 mm Stainless Steel M6 Bolts (Item 3) to attach the Ladder Mounting Brackets. Place a washer on the protruding bolt threads then install an M6 Self-Locking Nut (Item 9). Secure the brackets in place by tightening the bolt and nut using the Wrenches (Item 11).

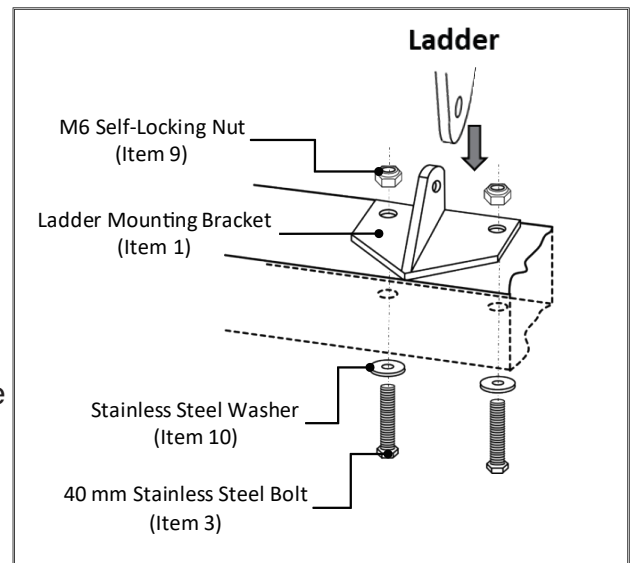

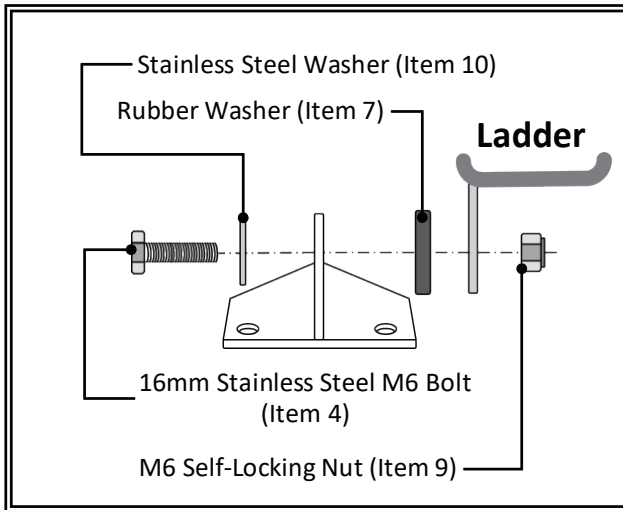

* Ladder capacity 350lbs

3. Once the Ladder Mounting Brackets are secured in place, lay the ladder on the base of the tent, and align the holes on the tabs of the ladder to the holes in the tabs on the Ladder Mounting Bracket.

4. Put a Rubber Washer (Item 7) between each set of tabs, then place a stainless-steel washer (Item 10) on each of two 16mm Stainless Steel M6 Bolts (Item 4) and insert the bolt through the tab holes.

5. Place a M6 Self-Locking Nut on the bolt threads and use the Wrenches (Item 11) to tighten.

6. Test that the ladder can pivot on the tabs. If it is too tight, loosen the nut by 1/8 to 1/4 turn.

Installing the Roof Top Tent onto your Roof Rack or Roof Bars

(Numbers in parenthesis refer to the Roof top tent hardware identification chart)

1. Ensure the vehicle is parked in a safe, flat spot. Use a minimum of two people, or a mechanical advantage system, to lift the Roof Top Tent and place onto the vehicle's roof rack or roof bars.

2. Insert a 55 mm Stainless Steel M8 Bolt (Item 2) into each of the eight Aluminum Slide Plates. Slide two slide plates into each of the Mounting Channels on one side of the vehicle, lift the roof top tent and slide them so the two plates and bolts are on the inside edge of the roof rack or roof bars.

Repeat this for the other side. Then slide two more plates into each of the Mounting Channels so these two plates and bolts are on the outside edge of the roof rack or roof bars. Repeat this for the other side. Refer to the Mounting

Diagram and ensure the slide plates are inserted correctly.

3. Check that the position of the Roof Top Tent is centered on the roof rack and that it is positioned to open on the desired side. Adjust the position as necessary.

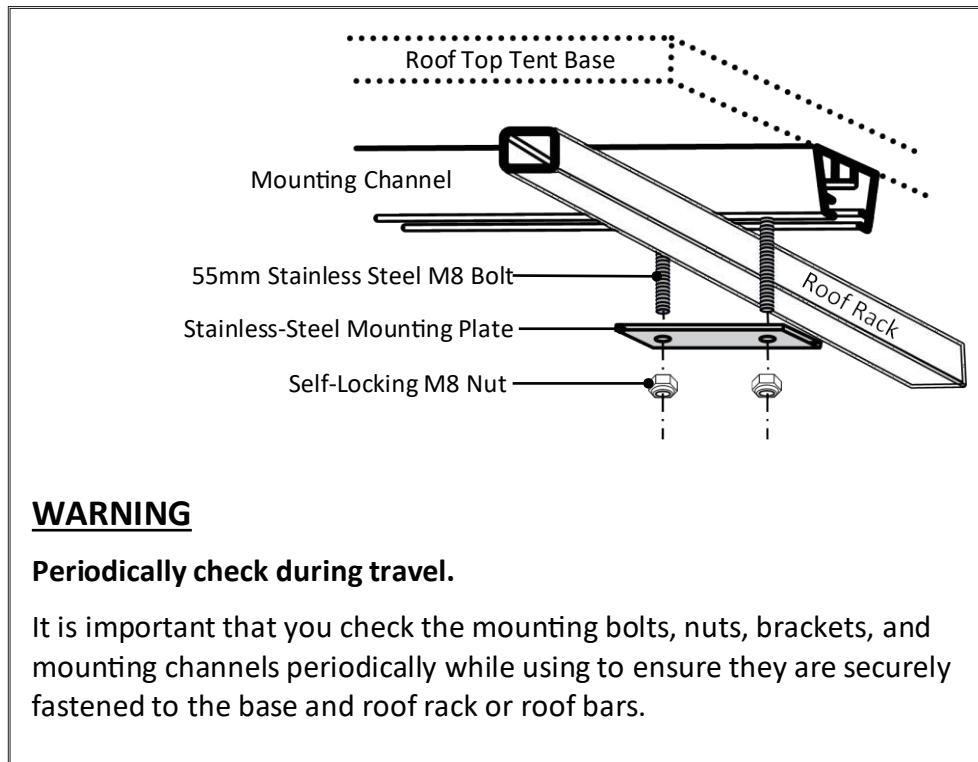

4. Attach the Roof Top Tent to your roof rack at the four points where the rack and Mounting Channels cross. Place a Stainless-Steel Mounting Plate (Item 5) onto the protruding 55mm Stainless Steel M8 Bolts (Item 2) then place a M8 Self-Locking Nut (Item 8) onto the threads of each bolt. Use a Wrench (Item 11) to tighten all eight nuts, but do not over-tighten.

5. After ensuring the Roof Top Tent is positioned correctly, and all eight nuts are tightened, insert the rubber end caps into the ends of the mounting channel (this may require light tapping using a mallet).

WARNING

Do Not Use the ladder at the incorrect angle.

The Ladder on the Roof Top Tent is designed to act as a brace and provide some support to the suspended base of the tent with an angle of approximately 60° relative to the ground. For your safety, DO NOT climb on the ladder if it is at 90° or at an angle less than approximately 60°. If the angle of the ladder is 90° and/or does not reach the ground, a ladder extension (not included) will be necessary. If the angle is too low, the ladder may need to be shortened by drilling additional holes above the existing locking pin holes. NEVER ADD HOLES BELOW THE EXISTING LOCKING HOLES. This will weaken the ladder and it will fail.

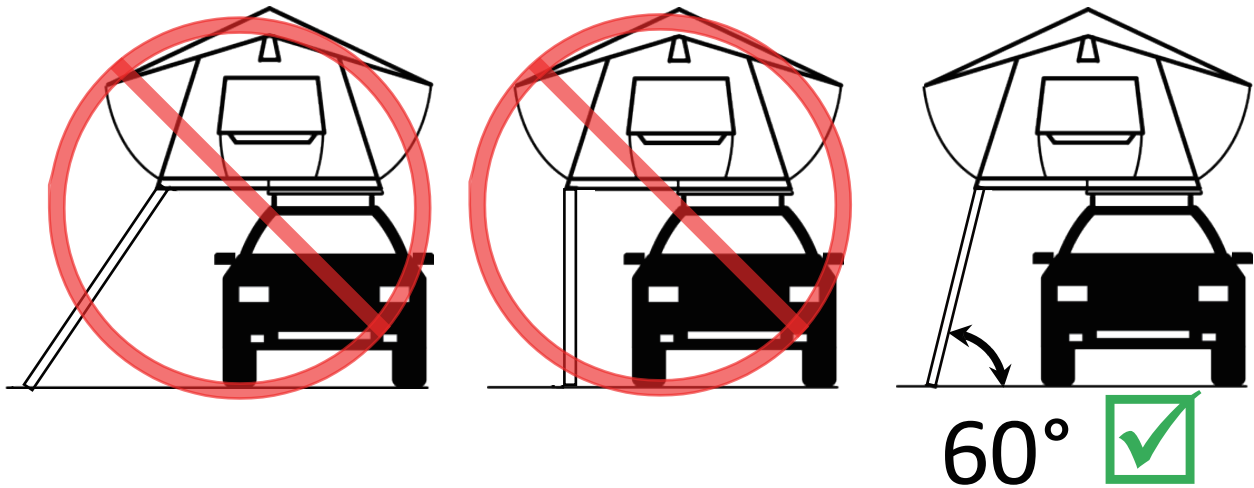



WARNING

Drive with Caution.

Any weight carried on the vehicle will adversely affect its handling particularly in cornering or in a cross wind and the vehicle should therefore be driven with increased caution.



WARNING

Do Not transport additional items inside the Roof Top Tent.

Additional items may shift or place excessive strain on the tent hinge which will cause damage. Properly store only original items that are used in your tent.

Set Up the Roof Top Tent

1. Park the vehicle on level ground and set the parking brake.
2. Remove the cover from the tent.
3. Release the hold down straps on the sides.
4. Slide the ladder out until the locking pins engage, then use the ladder as a lever to assist in opening the tent.
5. Adjust the ladder length so it is touching the ground and at an acceptable angle (approximately 60° relative to the ground). If the angle is too vertical, or if the ladder does not touch the ground, a ladder extension (not included) will be needed. Contact your distributor. If the angle is too small, shorten the ladder by changing to a different locking pin hole. If there is not a locking pin hole for the height needed, adjust the ladder to the correct angle, mark then drill new locking pin holes. **NEVER ADD HOLES BELOW THE EXISTING LOCKING HOLES.** This will weaken the ladder and it will fail.

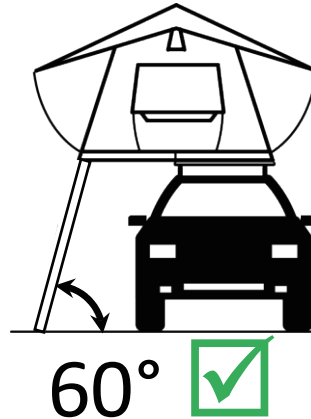

6. Install the rain fly by inserting the rain fly poles into the pockets on the sides of the tent, then tighten the straps on the rainfly.

7. Install the window rods on the rain fly and window shades. The window rods are designed to have tension and will have a "bow" when installed.

8. Unzip and roll up the screens and cover as desired. Use the hasps to hold them up.

Packing the Rooftop Tent

Follow the above steps in reverse order.



WARNING

The maximum capacity of this tent is 300kg (660lbs).

The tent will support up to 300kg after the vehicle is stopped, placed in park mode, with the parking brake set and with the tent properly set up. Overloading may cause injury or damage to the tent or vehicle.



WARNING

Always properly stow the tent prior to driving.

Never drive with a set up tent. Properly stow the tent and ensure the cover is fastened securely in place prior to driving.



WARNING

Always assist children and the infirm when using the ladder.

Do not let children use the ladder without supervision. A fall from small heights may result in serious injury. Use the straps to assist when entering the tent.

Additional Precautions for the Roof Top Tent

- When stowing the tent, it is unnecessary to use excessive force on the side retaining straps. These straps are only used to hold the tent base together and if excessive force is used to PULL the base together with these straps, they may fail.
- Try to avoid stowing the tent when wet. If you must stow the tent when wet, zip all doors and windows closed to try and prevent the inside of the tent from becoming wet. As soon as possible, and in a dry area, open the tent and allow it to thoroughly dry out to prevent mold and deterioration. Always ensure the tent is completely dry prior to any extended period of stowage.
- With a properly installed and stowed Roof Top Tent on a vehicle, the overall height of the vehicle is increased. Make note of the vehicle height and use caution when driving in areas with low overhangs.

Off-Vehicle Long Term Storage

- When storing off-vehicle, always ensure the tent is completely dry and stored in a dry area.
- Do not drag the stowed tent on the ground, doing so may damage the base or top.
- Avoid storing the stowed tent directly on the ground or concrete. If necessary, use wood blocks underneath the stowed tent to keep it from direct contact.



SKY RIDGE - 20011

ROOFTOP TENT

INSTALLATION INSTRUCTIONS



Care Instructions

- Clean only with cold water and a soft brush. Do not use soap, detergents, or bleach.
- Do not expose the tent to fuel, oil, or solvents.
- A new tent may experience weeping through the seams or fabric. This is normal and will stop after the fabric cures.
- The tent fabric may wear and lose its waterproofing over time. Re-proofing with a suitable waterproofing solution is recommended.

Tent Storage

If storing the tent off the vehicle, ensure the tent is packed away completely dry.

Be careful not to drag the tent on the ground. This will damage the cover and allow potential water ingress the next time you use your roof top tent

Do not store directly on concrete floor.

Tent Care

Do not expose to petrol, oil, or solvents.

New poly/cotton fabric will initially experience some weeping through the seams. This will reduce over time as the fabric cures.

Well-worn products may be re-proofed using a good quality waterproofing solution. This is highly recommended. Dry your products thoroughly before closing them. We recommend you air dry it in between adventures to prevent mildew and mold growth. These can lead to discoloration, foul odor and your tent material to degrade. Mold and mildew are not covered under warranty.

Periodically lubricate zipper teeth with non-scented bees wax. Make sure to keep them free from dust



SKY RIDGE - 20011

ROOFTOP TENT

INSTALLATION INSTRUCTIONS



and dirt. This will prolong the life of your zippers.

Ladder should be wiped free of any dust or dirt prior to collapse. Periodically spray the side rails with any silicone spray. DO NOT spray the ladder tread which can lead to slipping.

To clean your mattress cover, remove cover and machine wash using gentle cycle with delicate washing detergent. Hang Dry Only! DO NOT tumble dry.

To clean your fabric, use a mild detergent and warm water gently applied with a sponge. Rinse with a clean wet sponge and allow to completely air dry before storing.

Avoid excess sun exposure to prolong the life of your product UV rays can degrade fabric and waterproof coatings. If your product begins to break down, we suggest washing the fabric with a mild detergent and water solution followed by a treatment of a water repellent designed for tents. Consult your local outdoor retailer for other tent fabric care products and use as directed.