

Category: Jeep Accessories

Document Number: 5010067A

Date: 2/21/2017

Description: **Fridge / Freezer (FF31) Slide Installation**

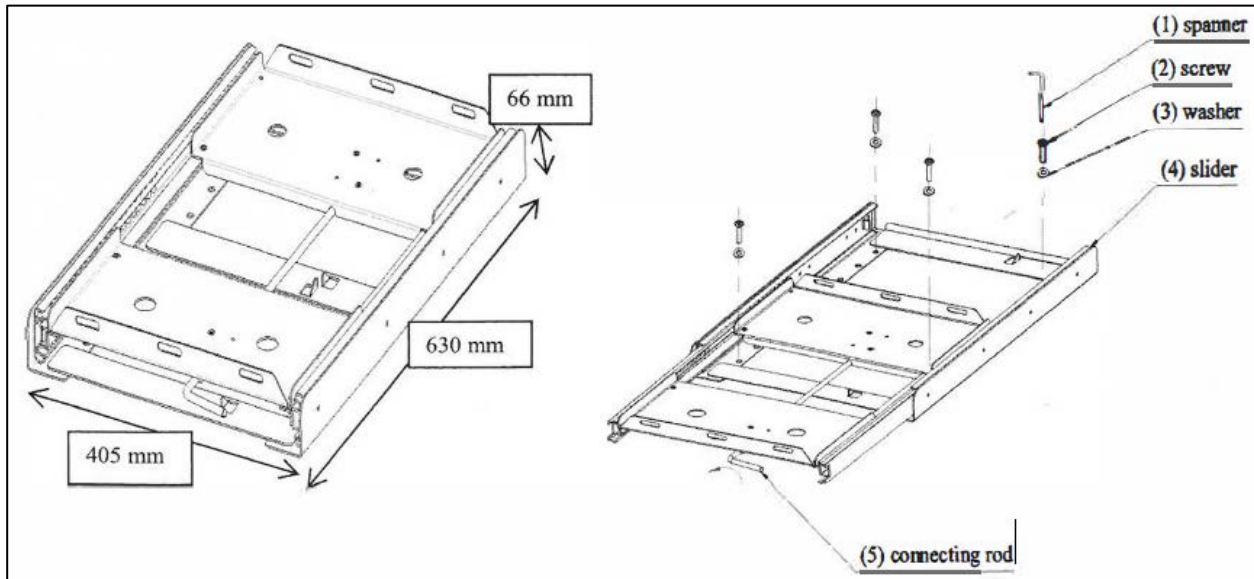

INSTALLATION INSTRUCTIONS

The slide assembly must be secured with a minimum of 6 equally spaced mounting bolts across the base frame. Depending on the mounting surface, the slide can be secured using self-tapping screws or nuts and bolts through the mounting holes located along the base frame.

IMPORTANT

Install the fridge only after the slide has been secured into position.

Steps:

- Place the slide assembly into the mounting position with the release handle facing outward or towards the opening position.
- Extend the slide assembly slowly by rotating the release handle in a counter-clockwise direction until tray is released.
- Commence installing the fasteners starting from the rear and moving forward using the 6 retaining holes.
- If the slide tray does not move smoothly, ensure the mounting surface is flat and all mounting hardware is tightening equally.
- When all fasteners are in place, slide installation is complete.

OPERATION

Rotate the handle counter-clockwise and pull to open.

WARNING

Secure the Frig / Freezer to the slide assembly before slide tray use. The slide assembly maximum load is 220 lbs. (100 Kg.)

If you have any questions, contact our technical support team at (800) 860-7866 or via email at: info-us@webasto.com.