



OMIX-ADA, Inc.

Part # 12107.10

460 HORIZON DR. SUITE 400 | SUWANEE, GA 30024 | PHONE: 770-614-6101 | FAX: 770-614-6069 | www.omix-ada.com

Wall Mount Door Holder

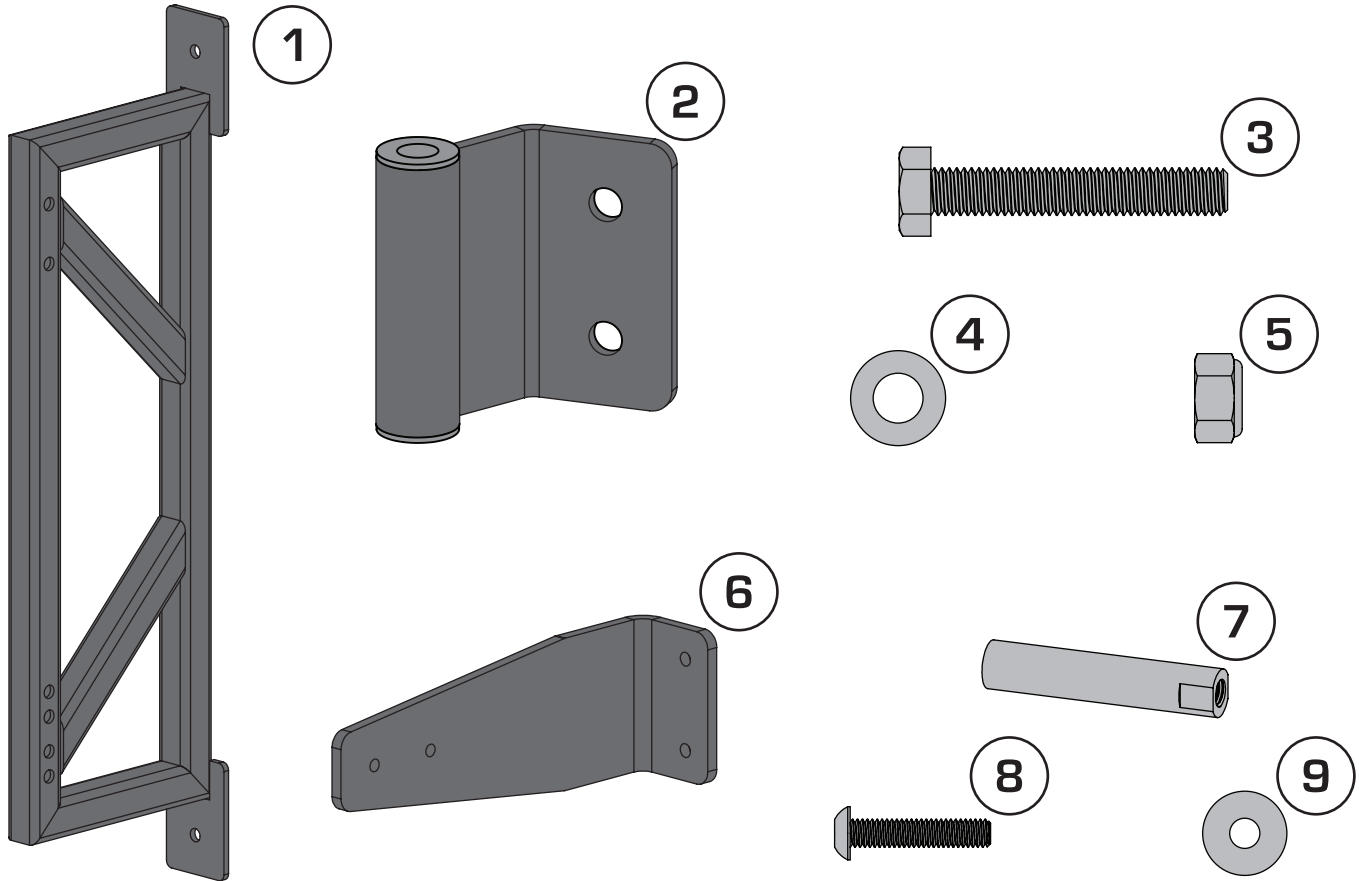

CAUTION

This product is designed to be mounted to a wall with wooden stud construction. Due to differences in building materials, mounting hardware is not supplied. **Failure to secure product to studs can result in damage to product, property, or serious injury.**

Components

- | | | | |
|----------------|-----|------------------|-----|
| 1. Door Holder | (1) | 6. Striker Plate | (2) |
| 2. Hinge | (4) | 7. Striker Bar | (2) |
| 3. M8 Bolt | (4) | 8. M4 Bolt | (2) |
| 4. M8 Washer | (8) | 9. M4 Washer | (4) |
| 5. M8 Nut | (4) | | |

OMIX-ADA® TECHNICAL SUPPORT

PHONE: M-F 8am - 5pm EST 1-800-449-6649 | TICKET: www.omixsupport.com

FOR WARRANTY INFORMATION VISIT: www.Omix-Ada.com



OMIX-ADA, Inc.

460 HORIZON DR. SUITE 400 | SUWANEE, GA 30024 | PHONE: 770-614-6101 | FAX: 770-614-6069 | www.omix-ada.com

Wall Mount Door Holder

1. Using a stud finder, locate wall stud and determine appropriate mounting position for Door Holder. Bottom of Door Holder must be at least 12" from floor.

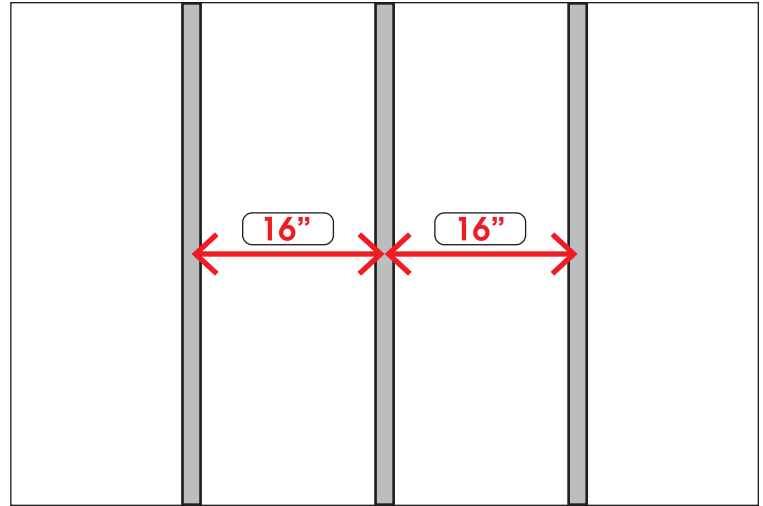

2. Using Door Holder for reference, mark and drill one 1/4" pilot hole in the center of each mounting hole. Pilot hole must go 2" into stud.

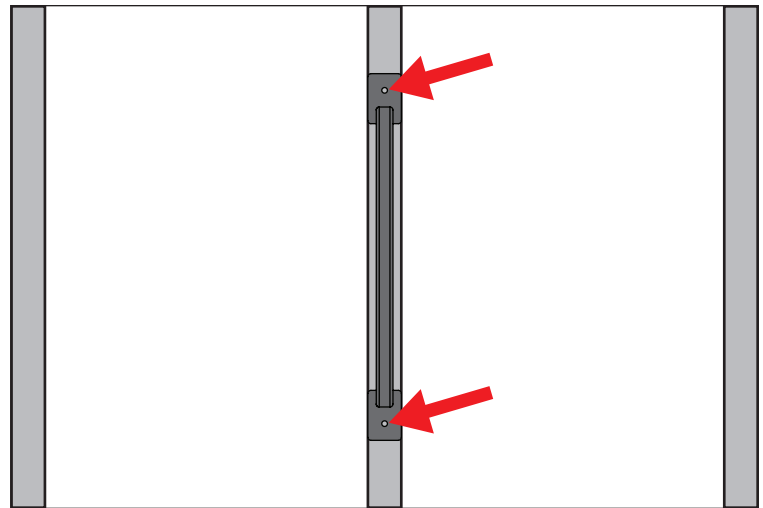

3. Determine proper length of 5/16" lag bolts for your application. Bolts must go 2" into stud.

4. Using 5/16" lag bolt and 5/16" flat washer, attach Door Holder to wall.

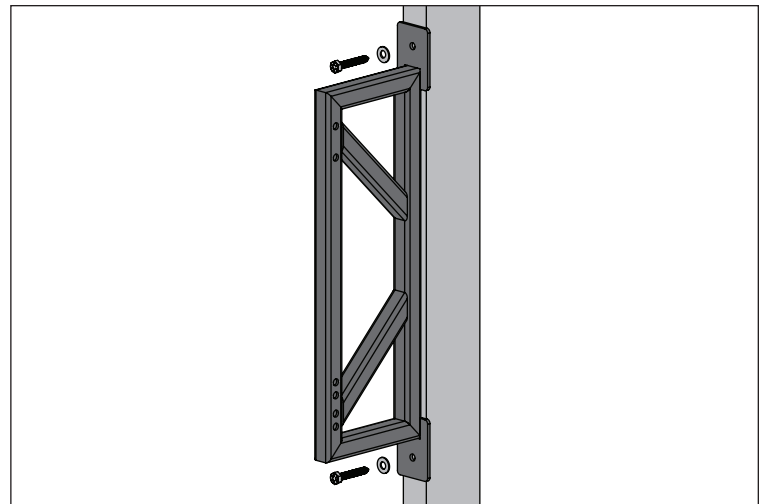



OMIX-ADA, Inc.

460 HORIZON DR. SUITE 400 | SUWANEE, GA 30024 | PHONE: 770-614-6101 | FAX: 770-614-6069 | www.omix-ada.com

Wall Mount Door Holder

5. Determine correct orientation of Hinge. For JK doors, bushing with larger opening should face upward. For non-JK doors, bushing with smaller opening should face upward.

6. Test for correct bushing by sliding hinge on door pin before installing. Bushing should slide on door pin with slight push in fitment.

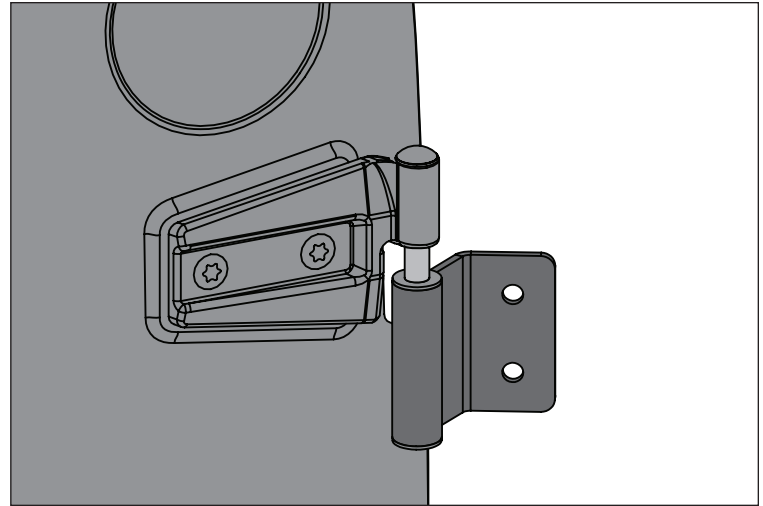

7. FOR JK DOORS:

Install Hinges on Door Holder using supplied M8 hardware. Install lower hinge in upper mounting position.

FOR NON-JK DOORS:

Install Hinges on Door Holder using supplied M8 hardware. Install lower hinge in lower mounting position.

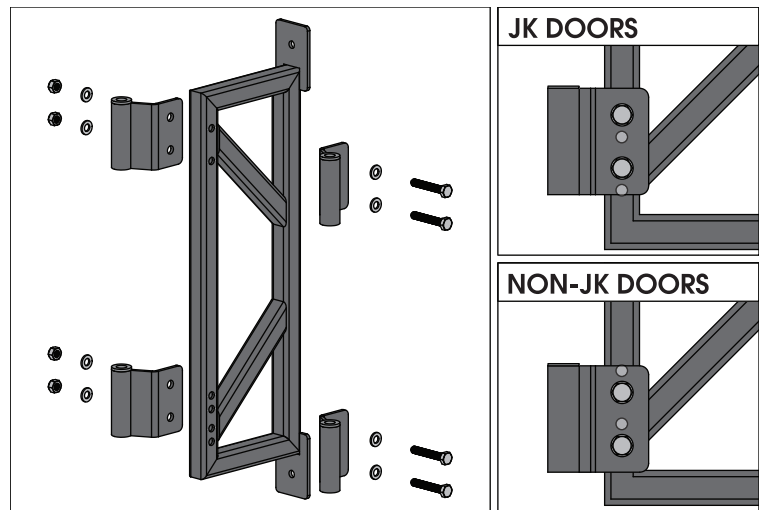

8. Install doors on Wall Mount Door Holder and rest doors against wall.

NOTICE

May need assistance from another person to remove/install doors.

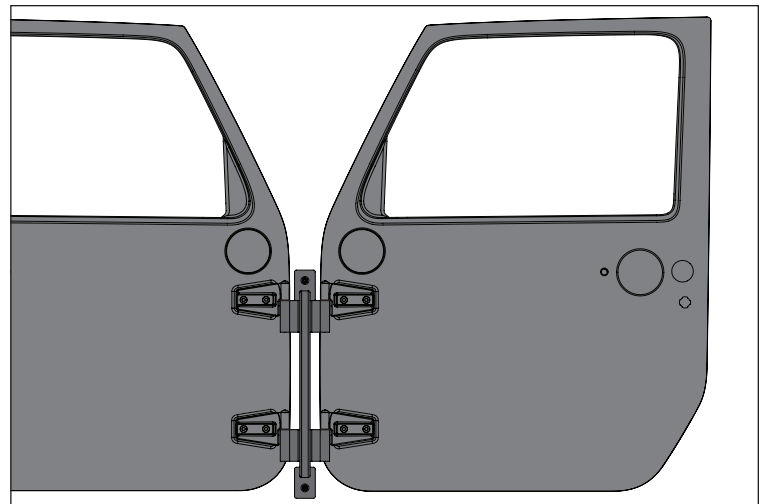



OMIX-ADA, Inc.



460 HORIZON DR. SUITE 400 | SUWANEE, GA 30024 | PHONE: 770-614-6101 | FAX: 770-614-6069 | www.omix-ada.com

Wall Mount Door Holder

9. FOR JK/TJ DOORS:

Fasten Striker Bar to Striker Plate in hole 1 using supplied M4 Hardware.

FOR YJ/CJ DOORS:

Fasten Striker Bar to Striker Plate in hole 2 using supplied M4 Hardware.

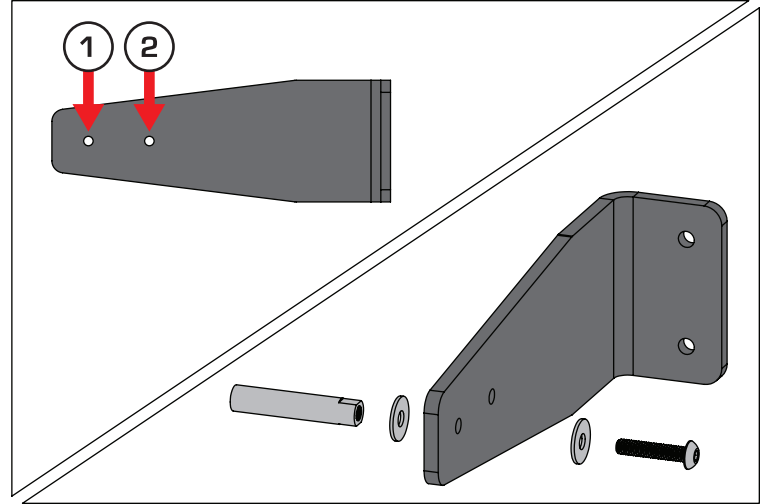

10. Determine correct Striker Plate mounting position. Place Striker Bar in door latch, with mounting flange flush against wall, and fasten to wall using proper fastener for your wall application.

