

Rusty's 2018 and Later JL Tire Carrier JBXL6767

INSTALLATION INSTRUCTIONS

Last Revised: 1/31/2019

Introduction:

Rusty's recommends that this installation be performed by a certified automotive technician or a person with professional mechanical knowledge. Installing this kit without this expertise may jeopardize the handling and safety of the vehicle.

Read instructions several times before starting. Be sure you have all the needed parts and know where they install. Read each step completely as you go. Exhaust modifications may be necessary. Prior to drilling or cutting, check behind the surface being worked on for any wires, lines, or hoses that could be damaged. After any drilling or cutting, remove burrs and grind smooth any surfaces. An inclinometer or similar tool may be needed to measure driveshaft angles before and after the installation.

Warning:

- It is the owners' responsibility to inspect all Rusty's products for proper torque specs to prevent loosening of components.
- Seat belts and shoulder harnesses should be worn at all times.
- Re-check all bolts and nuts after the first 100 miles and after any off-road usage during the first 300 miles.
- Although all of our products are made from the highest quality materials possible, they are not a substitute for Safe and Careful driving. In other words, have good safe on-road / off-road sense. Know the terrain, the speed limitations, and any obstacles that may lie ahead. Please remember to preserve our right to enjoy public land through the proper use of off-road vehicles.

Before Starting Installation:

1. Carefully Read all warnings and instructions completely before beginning.
2. Verify all parts have been received in this kit by checking the parts list on page#2 of this document.
3. Only install this kit on the vehicle for which it is specified.
4. Park the vehicle on a clean, dry, flat, level surface and block the tires so the vehicle cannot roll in either direction.
5. Be certain the vehicle is safely secured on jack stands or a vehicle lift prior to working around or under a vehicle. Never rely on a jack alone to support a vehicle's weight; use appropriately rated stands to support the vehicle's frame and any other heavy components.

Parts List:

Note: Please be sure that you have all the provided parts listed below before continuing with the installation.

Part #	DESCRIPTION:	Quantity
JBJL6767	Rusty's 2018 and Later JL Tire Carrier	1
RA-TC1-JL	Rusty's JL HD Adjustable Tire Mounting Bracket #1	1
RA-TC2-JL	Rusty's JL HD Adjustable Tire Mounting Bracket #2	1
RA-TC3-JL	Rusty's JL HD Hinge Mounts	2
RA-TC4567-JL	Rusty's JL HD Tire Carrier Assembly	1
RA-TCHSB-JL	Hinge Support Brace	1
RA-TCUHS-JL	Upper Hinge Shims 0.60" Thickness	2
AL-SPACER	1" O.D. x 1/2" I.D. x 0.450" Width Aluminum Spacer	2
RA-3BLM-JL	3rd Brake Light Mounting Bracket	1
RA-LTS-JL-SHORT	Short L Shaped Spare Tire Support	2
RA-LTS-JL-LONG	Long L Shaped Spare Tire Support	1
RH-338-HE	Rubber 3-3/8" Hinge Edge Protectors	2
MC-30645T861-JL	Tailgate Tether 1/8" Diameter x 12" Length	1
MC-FF621-01B	Oilite Bearings (1/2" I.D. x 3/4" O.D.) Flange (1" O.D. x 1/8" Thickness)	4
88628169	1/2" x 3" Shoulder Bolt (Stainless Steel)	2
F-37264	3/8"-16 Zinc Finish Steel Top Lock Nut	2
MC-9750K22	7/8" Head Diameter Plastic Round Plug (Fits 1/2" I.D.)	2
74454919	1/2"-13 x 1-1/2" Length Grade 8 Hex Head Cap Screw	9
05724646	1/2" SAE Flat Washer	18
67488965	1/2"-13 Grade 8 Hex Lock Nut	9
67563080	1/4"-20 x 3/4" Length Button Head Cap Screw	7
08411266	1/4"-20 Knurled Threaded Nut Insert	5
09331745	1/4"-20 UNC Manual Threaded Insert Installation Tool	1
List Continued on Page 3		

Parts List:

Note: Please be sure that you have all the provided parts listed below before continuing with the installation.

Part #	DESCRIPTION:	Quantity
52593571	1/4"- 20 Grade 8 Hex Lock Nut	2
67490409	1/4" SAE Flat Washer	4
05725072	1/4"-20 x 3/4" Length Hex Head Cap Screw	2
09889072	M10 x 1.50mm x 40mm Length Hex Head Cap Screw	6
67486001	M10 x 1.50mm Grade 8 Hex Lock Nut	6
67746602	3/8" x 13/32" O.D. SAE Flat Washer	14
66459959	M8 x 1.25mm x 40mm Length Hex Head Flange Bolts	6
67476648	M8 x 1.25mm Hex Nut	14
MC-92125A242	M6 x 1mm x 25mm Length Stainless Steel Hex Drive Flat Head Screw	2

Installation Instructions

Note: Save all factory components and hardware for reuse, unless noted.

1. Park the vehicle on a level surface before starting the installation process.
2. Remove the rear passenger side tail light assembly. (Refer to Owner's Manual Section 7– Page 383)
3. Remove the rear passenger side interior panel.
 - A. Remove the seat belt retainer trim from the rear passenger side interior panel.
 - B. Carefully pry the trim panel out of place, by starting at the front of the vehicle. The position of the panel snaps may vary in some models.

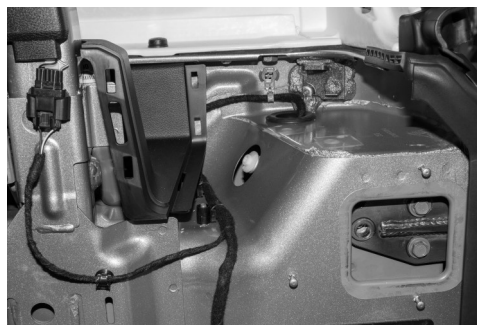

4. Locate and remove the stickers (Qty:2) that cover the tailgate hinge bolts
5. Remove the rear tailgate interior panel.



6. Open the rear window and close the tailgate door. This done so that you may gain access to as needed with out having to open the rear tailgate door.

******DO NOT OPEN THE TAIL GATE DOOR UNTIL INSTRUCTED TO OPEN.******

7. Remove the spare tire from the factory tire carrier mount. (**Note:** Have an assistant help you lift the tire off of the carrier.)

Installation Instructions (Continued)

Note: Save all factory components and hardware for reuse, unless noted.

- Loosen the (Qty:8) 13mm bolts marked in the image below. Do not fully remove hardware at this time to ensure that the factory tire carrier is still held into position.



- Remove the rear spare tire mount 3rd brake light bracket cover by removing the (Qty:7) T25 Torx bolts marked in the image below. Then remove the (Qty:4) T25 Torx bolts that secure the 3rd brake light mounting bracket to the spare tire carrier mount.

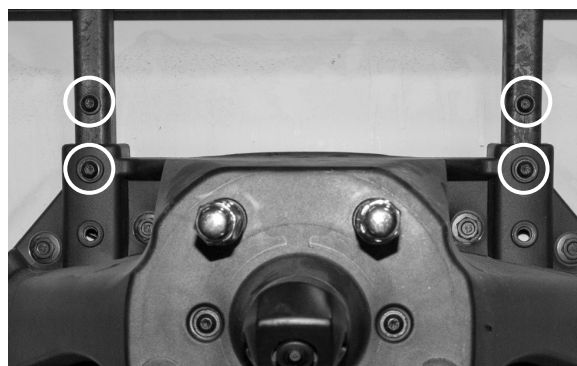

- Carefully remove the 3rd brake light wiring harness from the inside of the 3rd brake light mounting bracket assembly. (**Note:** Be careful not to damage this wiring harness or connector so that it can be reused in the reassembly.)
- Remove the 3rd brake light from the mount by removing the (Qty:2) T25 Torx bolts then disconnect the wiring harness from the 3rd bracket light connector. (**Note:** Retain hard ware to be reused.)

Installation Instructions (Continued)

Note: Save all factory components and hardware for reuse, unless noted.

12. Remove the (Qty:8) 13mm bolts loosened in step#8 at this time to remove the entire factory spare tire carrier from the tailgate assembly. (**Note:** Retain hard ware to be reused.)
13. With the help from an assistant have them hold the factory spare tire mount and remove (Qty:2) T25 Torx bolts shown in the image below. Press against the lug nut studs to remove the lug nut plate/back up camera mount from the spare tire mount.



14. Remove the back up camera from the lug nut plate/back up camera mount by removing the (Qty:3) T8 Torx bolts as shown in the image below. Once the camera is unbolted disconnect wire by unplugging the connector on the back side of the camera. (**Note:** Retain hardware to be reused.)

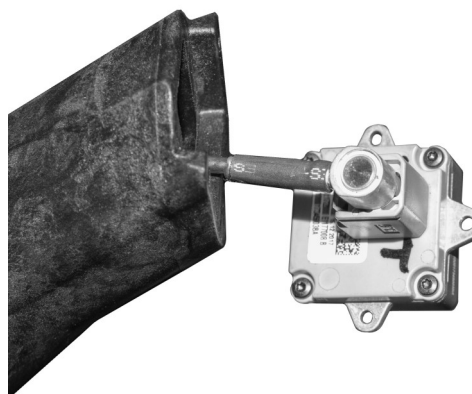
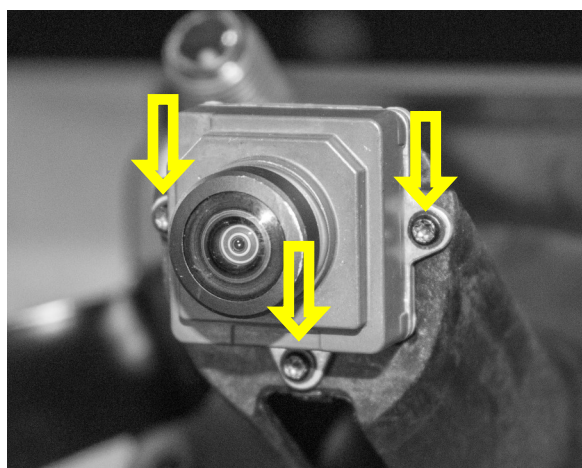

15. Pull the back up camera wire from the back side of the lug nut plate/back up camera mount and set aside the lug nut plate/back up camera mount for reuse. (**Note:** Be careful not to damage this wiring harness or connector so that it can be reused in the reassembly.)

Installation Instructions (Continued)

Note: Save all factory components and hardware for reuse, unless noted.

16. Clean all of the exposed surfaces that will be covered by the new tire carrier assembly.
17. Apply masking tape horizontally across the opening of the rear tail gate door in 3 locations. Make sure to apply tape to both the driver and passenger side of the rear tailgate. (**Note:** This step is needed in order to ensure that the door is located properly back into the original location.)



18. Shim the rear tailgate to prevent movement when installing the new tire carrier in the upcoming steps. (**Note:** It is a good idea to use a spacer or small wood wedge to support the tailgate during the following steps to prevent movement.)
19. Remove the factory tailgate hinge assemblies (Qty:2) by completing the steps below.
 - A. Make sure that the tailgate is closed completely!
 - B. Remove the (Qty: 4) (Qty:2 Per Hinge) T55 Torx bolts located on the outside of the hinges to remove the factory hinge assemblies from the tailgate with the use of a T55 Torx Driver.
 - C. Remove the (Qty:6) (Qty:3 Per Hinge) factory 13mm bolts located on the inside of the rear cargo area. (**Note:** Do not open the rear tailgate to access. Reach over the tailgate or access by crawling into the cargo area from one of the passenger doors.)

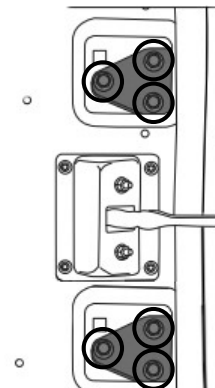
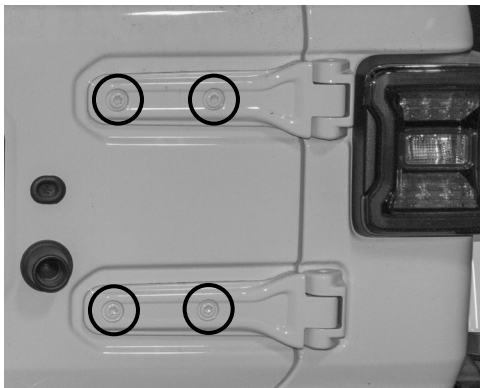

Installation Instructions (Continued)

Note: Save all factory components and hardware for reuse, unless noted.

20. Install the supplied (Qty:2) Rusty's JL HD Hinge Mounts to the Rusty's JL HD Tire Carrier Assembly.
- Rotate and insert the supplied (Qty:2) Rusty's JL HD Hinge Mounts to the Rusty's JL HD Tire Carrier as shown in the images below.
 - Align and install the (Qty:2) 1/2" x 3" Shoulder Bolts. (**Note:** Apply a small amount of anti-seize to each bushing on the inside and outside prior to installation.)
 - Start the (Qty:2) 3/8"-16 Zinc Finish Steel Top Lock Nuts on the tire carrier shoulder bolts. Snug, but do not tighten at this time.



21. Install the supplied (Qty:2) 3-3/8" Rubber Hinge Edge Protectors to the outside opening of the body where the factory hinges were removed from as shown in the image below. (**Note:** It maybe helpful use a light amount of soapy water to slide the edge protectors into position.)



Installation Instructions (Continued)

Note: Save all factory components and hardware for reuse, unless noted.

22. Refer to the chart below and install the supplied **upper** hinge shim(s) if needed for your application. (**Note:** The lower hinge will not require the use of a shim.) Align the holes of the supplied upper hinge shim(s) to the upper hinge holes. Use masking tape to secure the shim(s) to the hinge to make the installation of the hinge to the vehicle much easier. (**Note:** Please note that the number of shims could potentially vary as the weight of your spare wheel and tire combination may require more or less shims, this should be treated as a starting point and adjust if needed.)

(**Note:** Please note that the number of shims could potentially vary as the weight of your spare wheel and tire combination may require more or less shims, this should be treated as a starting point and adjust if needed.)

	33" Tire	35" Tire	Heavy 35" Tire	37-39" Tire	40" or Larger
No Shim					X
1 Shim			X	X	
2 Shims	X	X			



Installation Instructions

Note: Save all factory components and hardware for reuse, unless noted.

23. With the help of an assistant install the Rusty's JL HD Tire Carrier Assembly by inserting and aligning the upper and lower hinges to the factory hinge mounting points. Start the supplied (Qty:6) M8 x 1.25mm x 40mm Length Hex Head Flange Bolts (3 Bolts Per Hinge) to fasten the hinges to the vehicle. (**Note:** To install the hinge mounts you will need to access the rear cargo area to install the hardware. You can either reach over the rear tailgate door or open one of the rear passenger doors and crawl into the rear cargo area.)



24. Rotate the Rusty's JL HD Tire Carrier Assembly and align the hole locations of the factory rear tailgate with the hole locations in the Tire Carrier Assembly. It may be necessary to loosen the hinge mounting hardware slightly to allow for proper alignment. Retighten hinge hardware to prevent movement. (**Note:** Take your time to ensure that the alignment is correct before continuing. Do not fully tighten the (Qty:6) M8 x 1.25mm x 40mm Length Hex Head Flange Bolts (3 Bolts Per Hinge) so that you can allow for a slight amount of movement if needed.)

25. Remove the factory spare tire bumper pads from the tailgate

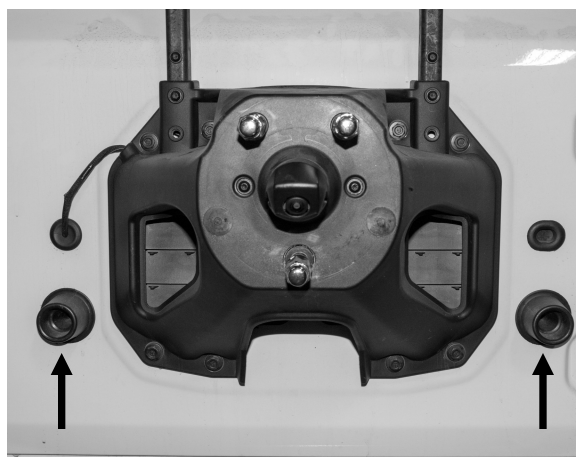

26. Install the supplied 7/8" Head Diameter Plastic Round Plug (Fits 1/2" I.D.) (Qty:2) in to the hole locations in the tailgate where the factory spare tire bumper pads were removed in the previous step.

Installation Instructions

Note: Save all factory components and hardware for reuse, unless noted.

27. Rotate the Rusty's JL HD Tire Carrier Assembly to the factory rear tailgate door to align the factory mounting hole in the tailgate with the hole locations of the tire carrier assembly. Apply a small amount of anti-seize and install the (Qty:8) Factory 13mm bolts removed during step 12 to the marked hole locations in diagram below. Do not fully tighten until instructed! (**Note:** Before installing the factory 13mm bolts remove each of the plastic washers from the threads and discard.)

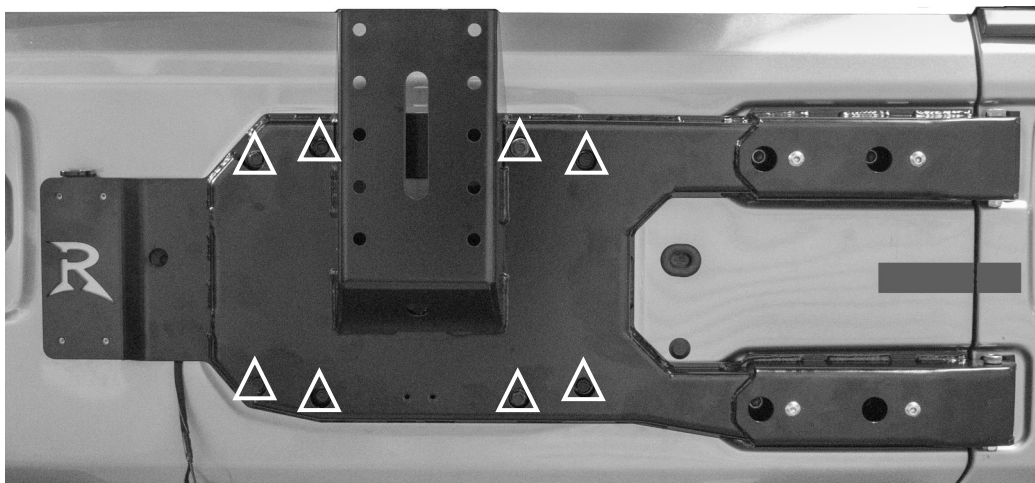

28. Apply a small amount of anti-seize and install the supplied (Qty:4) M10 x 1.50mm x 40mm Length Hex Head Cap Screw (Qty:4) 3/8" SAE Flat Washers to the marked hole locations in diagram below. Do not fully tighten until instructed!

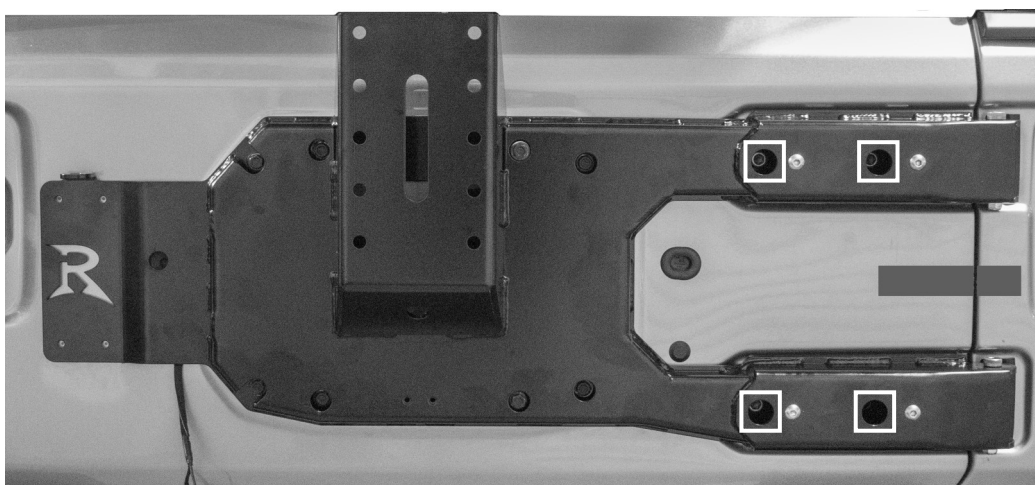

29. With all the hardware from steps 27-28 installed tighten all the hardware so that the tire carrier is seated against the tailgate completely and can not move. You do not have to torque hardware completely at this time since it will need to be removed in the following steps.

Installation Instructions

Note: Save all factory components and hardware for reuse, unless noted.

30. Mark and drill the hole locations for the Tailgate Strengthenener/Antenna Mount.

- A. Mark and center punch the four hole locations shown in the image below.
- B. Remove the hardware that was installed in steps 27 and 28 to swing the Rusty's JL HD Tire Carrier Assembly out of the way before continuing.
- C. Drill the four hole locations to 25/64" (.3906") marked in step 30-A. Take precautions to make sure you do not drill the holes too large. Using the correct drill bit is critical for this step.
- D. Install the supplied 1/4"-20 Knurled Threaded Nut Inserts (Qty:4) in the hole locations drilled to 25/64" (.3906") Follow the instructions provided with the included 1/4"-20 UNC Manual Threaded Insert Installation Tool.



31. Route the factory wiring harness through the Rusty's JL HD Tire Carrier Assembly as shown in the images below. Carefully pull the wiring slowly while pushing the Rusty's JL HD Tire Carrier Assembly against the factory tailgate.

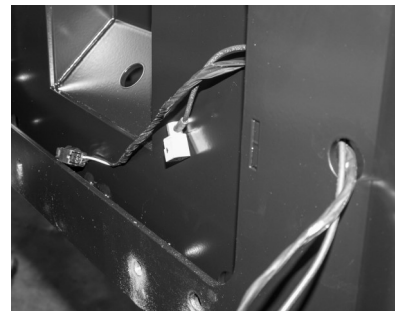
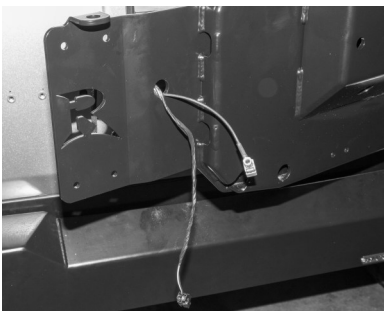

Installation Instructions

Note: Save all factory components and hardware for reuse, unless noted.

32. Apply a small amount of anti-seize and install the hardware marked below to install the Rusty's JL HD Tire Carrier Assembly to the factory rear tailgate door. Start all hardware first then work in a cross pattern until all hardware has been tightened to the correct torque values.

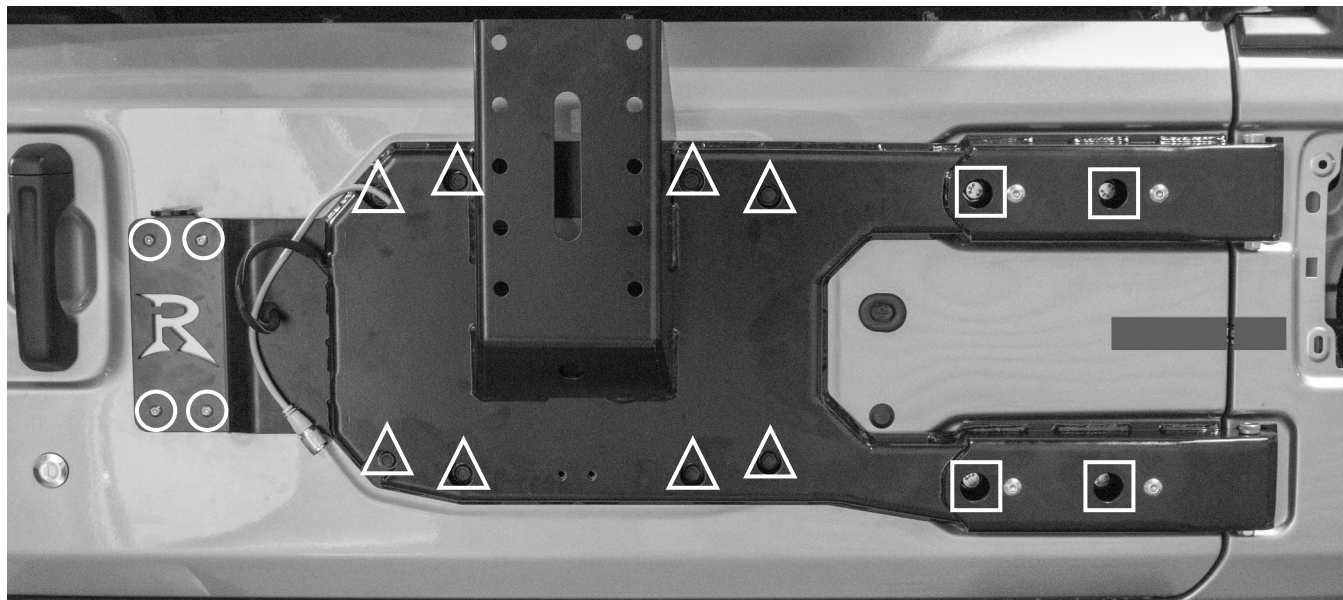

Symbol	Hardware	Torque
○	1/4"-20 x 3/4" Length Button Head Cap Screw	11 in.-lbs.
△	13mm Factory Bolts	22 ft.-lbs.
□	M10 x 1.50mm x 40mm Length Hex Head Cap Screw	40 ft.-lbs.

Installation Instructions

Note: Save all factory components and hardware for reuse, unless noted.

33. Install the supplied (Qty:8) M8 x 1.25mm Hex Nuts to the exposed threads of the factory 8mm bolts installed in step 27 as shown in the images below.

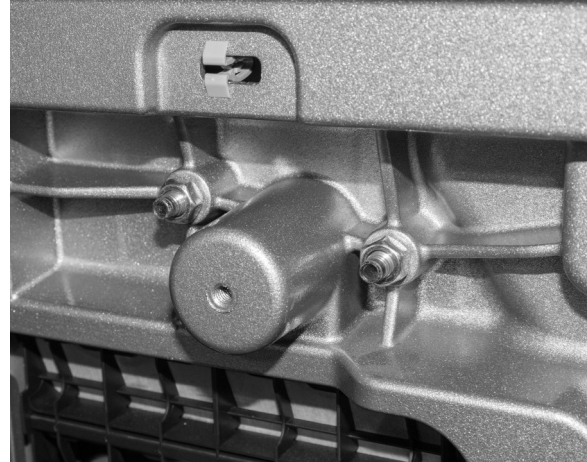
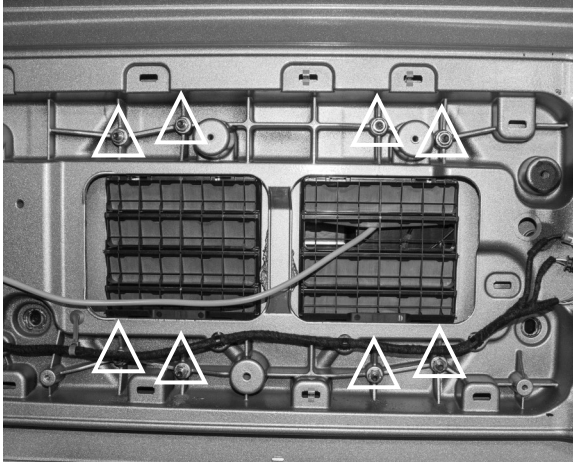

34. Install the supplied (Qty:4) M10 x 1.50mm Grade 8 Hex Lock Nut to the exposed threads of the factory 8mm bolts installed in step 28 as shown in the images below.

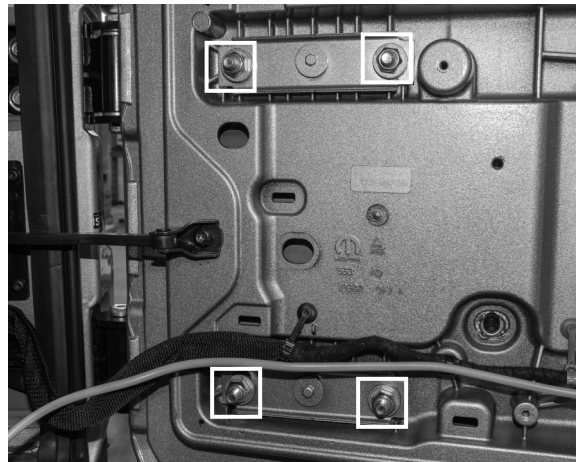

35. Route any additional wiring for antennas or other devices at this time if needed. Reinstall the factory plastic trim for the tailgate at this time or wait until the installation is completed if preferred.

Installation Instructions

Note: Save all factory components and hardware for reuse, unless noted.

36. Fasten the factory 3rd brake light to the supplied (Qty:1) 3rd Brake Light Mounting Bracket as shown in the image below using the (Qty:2) T25 Torx bolts. The orientation of the 3rd brake light can be installed in either direction, but with some wheel sizes it will need to be mounted to the supplied bracket as shown in the image below on the right.

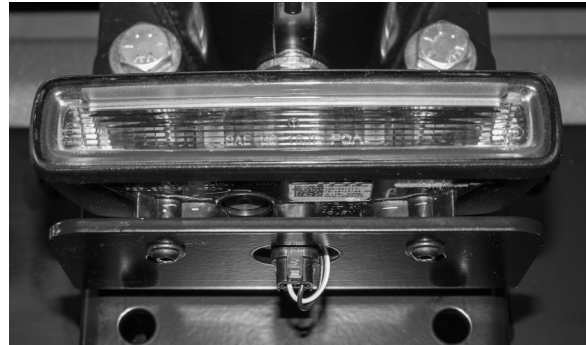

37. Locate the Rusty's JL HD Adjustable Tire Mounting Bracket #2. Note there are several possible mounting holes to attach this bracket to the tailgate assembly. The size of the spare tire and the bumper design will determine which hole locations on the tailgate bracket will be the best for your application. Secure the bracket to the tailgate using the supplied hardware: in the top two holes ONLY :(Qty:2) 1/2"-13 x 1-1/2" Length Grade 8 Hex Head Cap Screw, (Qty:4) 1/2" SAE Flat Washer, & (Qty:2) 1/2"-13 Grade 8 Hex Lock Nut. Do not tighten at this time.

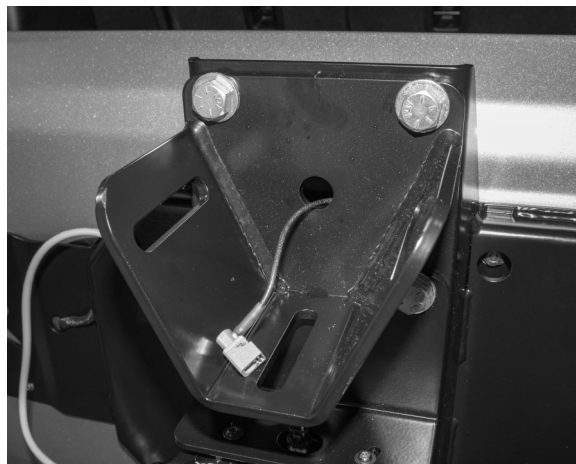

Installation Instructions

Note: Save all factory components and hardware for reuse, unless noted.

38. Install the 3rd brake light assembly assembled in step 36.

- A. Loosely install the 3rd brake light assembly to the bottom two hole locations of the Rusty's JL HD Adjustable Tire Mounting Bracket #2 using the supplied hardware: (Qty:2) 1/2"-13 x 1-1/2" Length Grade 8 Hex Head Cap Screw, (Qty:4) 1/2" SAE Flat Washer, & (Qty:2) 1/2"-13 Grade 8 Hex Lock. (Image 38-A)
- B. Route the 3rd brake wiring harness through the center slot of the Rusty's JL HD Tire Carrier Assembly and the hole in the 3rd brake light assembly. (Image 38-B)
- C. Attach the wiring harness to the 3rd brake light. (Image 38-C)

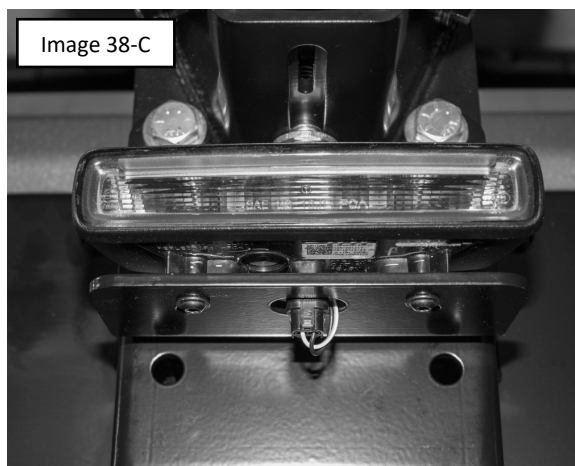
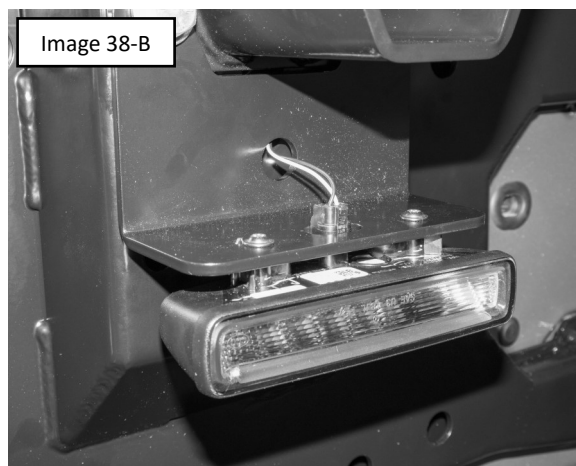
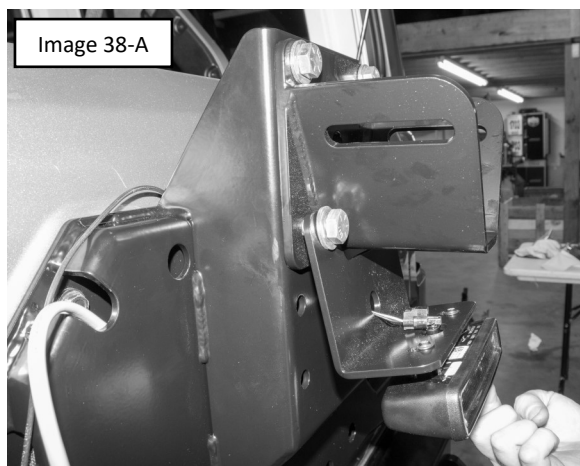

Installation Instructions

Note: Save all factory components and hardware for reuse, unless noted.

39. Tighten the 1/2" hardware installed in steps 28-29 to 80 ft.-lbs.

40. Prepare the lug nut plate/back up camera mount and backup camera to be installed by completing the following steps.

- A. Route the backup camera wiring harness through the hole in the center of Rusty's JL HD Adjustable Tire Mounting Bracket #2 (Image 40-A)
- B. Route the wiring harness through the center of the lug nut plate/back up camera mount (Image 40-B)
- C. Reconnect the factory backup camera to the factory wiring harness. (Image 40-C)
- D. Secure the backup camera to the lug nut plate/back up camera mount using the factory hardware (Qty:3) T8 Torx bolts (Image 40-D)

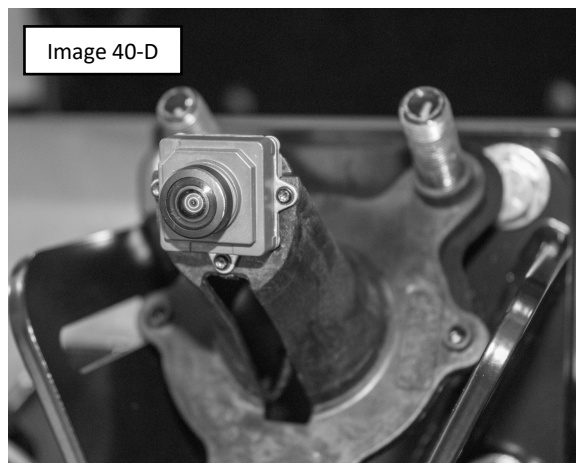
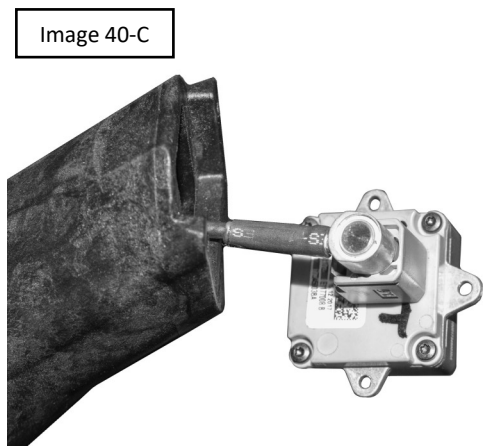
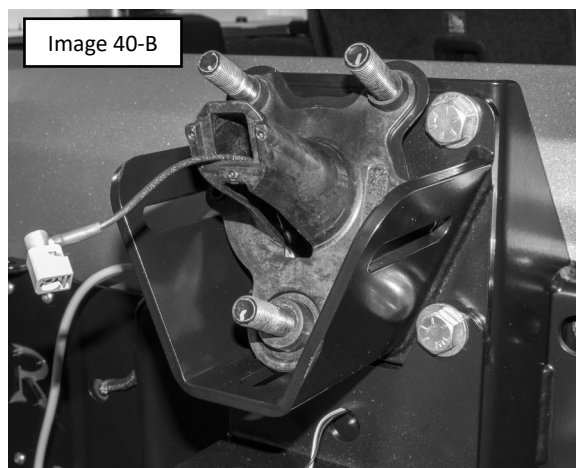
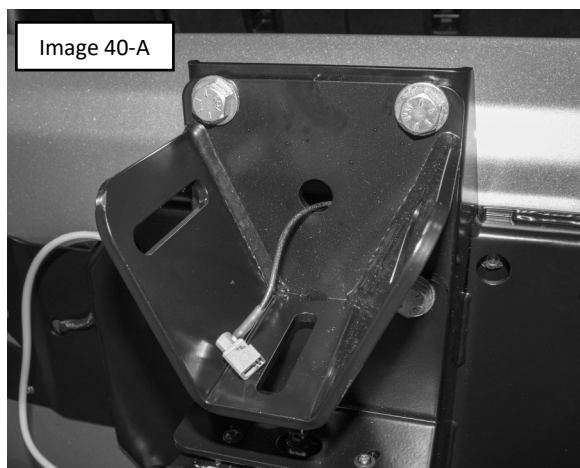

Installation Instructions

Note: Save all factory components and hardware for reuse, unless noted.

41. Install the Rusty's JL HD Adjustable Tire Mounting Bracket #1 by completing the following steps.
- A. Align the slots on the Rusty's JL HD Adjustable Tire Mounting Brackets #1 & #2.
 - B. Install the supplied (Qty:5) 1/2"-13 x 1-1/2" Long Grade 8 Hex Head Cap Screws, (Qty:10) 1/2" SAE Flat Washers, & (Qty:5) 1/2"-13 Grade 8 Hex Lock Nuts to hold the two brackets to one another. Do not fully tighten the hardware at this time to allow for adjustment if needed. (Image 41-B)
 - C. Pull the Rusty's JL HD Adjustable Tire Mounting Bracket #1 rearward and align and insert the lug nut plate/back up camera mount to the Rusty's JL HD Adjustable Tire Mounting Bracket #2.
 - D. Install the supplied (Qty:2) M6 x 1mm x 25mm Length Stainless Steel Hex Drive Flat Head Screws (Image 41-D)

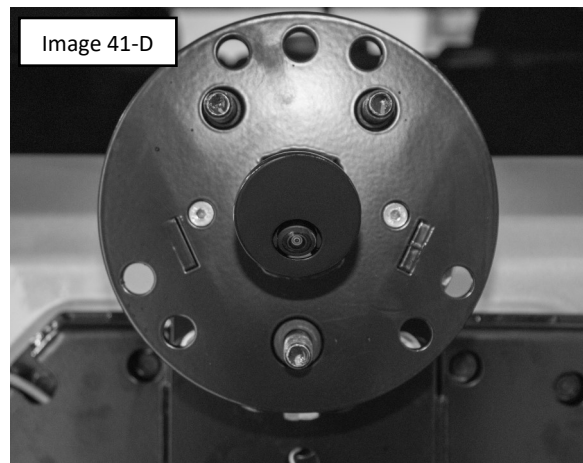
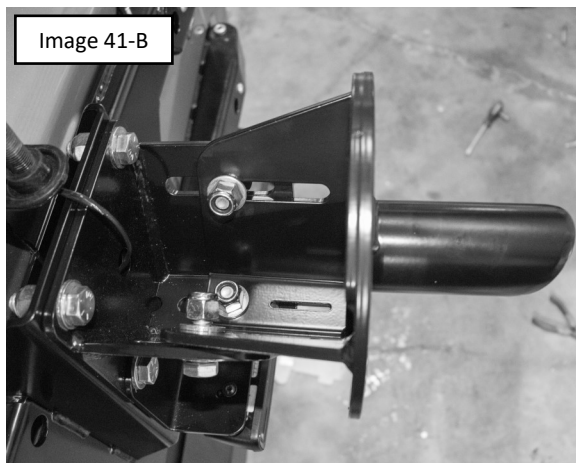

This tire carrier can also be used with ? Bolt patterns if desired in the event that you have upgraded to different axles. You will need to source and install the correct wheel studs for your application and remove the factory wheel studs from the factory lug nut plate/back up camera mount .

42. Double check all of the hardware used to install the hinge and Rusty's JL HD Tire Carrier Assembly from steps 23 and 32 before continuing.

Installation Instructions

Note: Save all factory components and hardware for reuse, unless noted.

43. Install the supplied Hinge Support Brace by completing the following steps.
- Insert the supplied (Qty:2) M10 x 1.50mm x 40mm Length Hex Head Cap Screws and 3/8" SAE Flat Washers through the unused hole locations of upper and lower hinges. (Image 43-A)
 - Slide the supplied (Qty:2) 1" O.D. x 1/2" I.D. x 0.450" Width Aluminum Spacer as shown in the image below. (Image 43-B)
 - Install the supplied Hinge Support Brace by aligning with upper and lower hinge hardware and sliding over the threads. (Image 43-C)
 - Make sure the tape lines are correct on driver and passenger side of the tailgate, Adjust if needed, pull on the passenger side of the tailgate rearward/forward to correctly align the tail gate with the body.
 - Tighten the (Qty:6) M8 x 1.25mm x 40mm Length Hex Head Flange Bolts to secure the position of the tire carrier. (Image 43-A)
 - Loosely Install the supplied (Qty:2) M10 x 1.50mm Grade 8 Hex Lock Nut and (Qty:6) M8 x 1.25mm Hex Nut. (Image 43-D)
 - Tighten nuts install in the step 43-D once all have been installed.

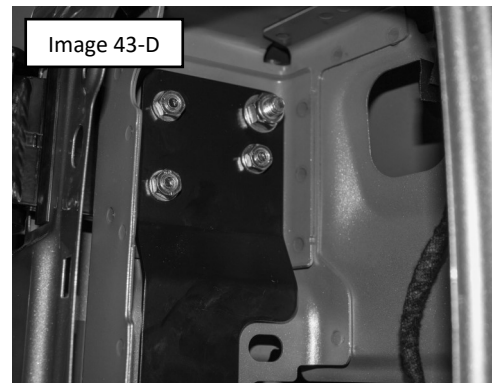
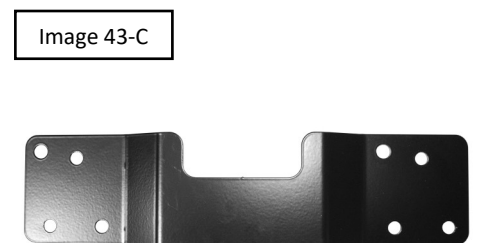
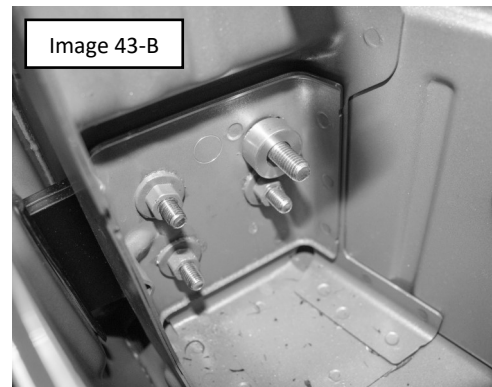
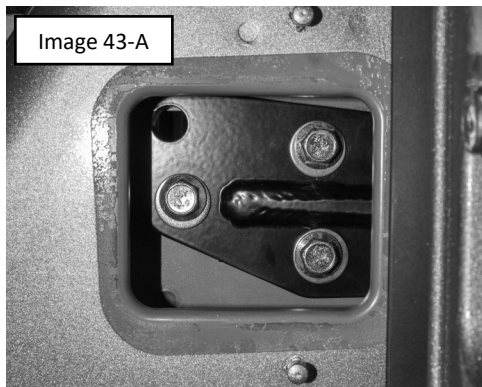

Installation Instructions

Note: Save all factory components and hardware for reuse, unless noted.

44. Tighten the two (Qty:2) 1/2" x 3" Shoulder Bolts and (Qty:2) 3/8"-16 Zinc Finish Steel Top Lock Nuts installed in the hinge assemblies to adjust the resistance of the tailgate when opening. Do not over tighten.
45. Carefully open and close the tailgate at this time to check for any binding or alignment issues by referencing the masking tape lines applied in step 17. (**Note:** Do not open the tailgate past the factory limit point.) If the tailgate needs to be adjusted, do not remove any hardware installed on the tire carrier itself, you will only make adjustments where the hinges plates attach to the vehicle. When the adjustments needed are very small you can likely loosen the hinge hardware and rotate or lift the tailgate door until and re-tighten the hardware once alignment is achieved. In the event that the alignment can not be achieved in this manner you will likely need to either add or remove a shim(s) behind the upper hinge, then realign the tape lines. If the driver side of the tailgate is high in adjustment you will need to install another of the supplied shims to the upper hinge. If the driver side of tailgate is low in adjustment you will need to remove a shim.

(**Note:** Please note that the number of shims could potentially vary as the weight of your spare wheel and tire combination may require more or less shims, this should be treated as a starting point and adjust if needed.)

	33" Tire	35" Tire	Heavy 35" Tire	37-39" Tire	40" or Larger
No Shim					X
1 Shim			X	X	
2 Shims	X	X			



Installation Instructions

Note: Save all factory components and hardware for reuse, unless noted.

47. Install the supplied 2007-2011 JL Wrangler Tailgate Tether by completing the following steps.

- A. Remove the T?? Torx Bolt and slide flat end of the supplied 2007-2011 JL Wrangler Tailgate Tether beneath the factory door limiting arm.
- B. Pull the tether straight ahead and mark the hole location of the bent end of the supplied 2007-2011 JL Wrangler Tailgate Tether. (Note: The Rear tailgate should be opened to about 90 degrees from the closed position. You want the tether to be timed to match closely to the factory tailgate limits. This will typically be about 1/2" from the edge of the stamped metal cover of the existing tailgate door limiter.)
- C. Drill the hole location to 25/64" (.3906") marked in step 24-A. Take precautions to make sure you do not drill the holes too large. Using the correct drill bit is critical for this step.
- D. Install the supplied 1/4"-20 Knurled Threaded Nut Insert (Qty:1) in the hole location drilled to 25/64" (.3906") Follow the instructions provided with the included 1/4"-20 UNC Manual Threaded Insert Installation Tool.
- E. Attach the bent end of the tether using the supplied 1/4"-20 x 3/4" Length Button Head Cap Screw (Qty:1) to the installed Threaded Nut Insert.

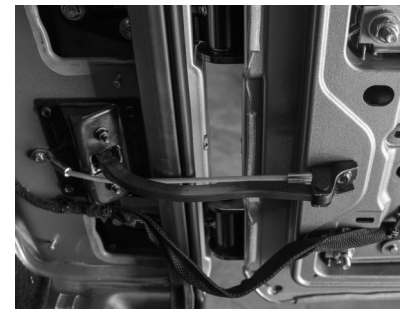
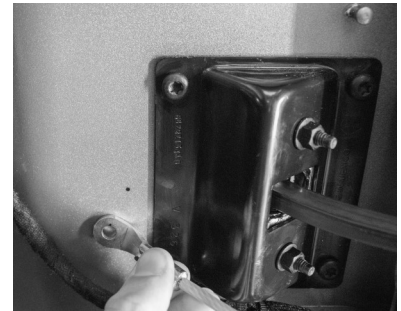

Installation Instructions

Note: Save all factory components and hardware for reuse, unless noted.

48. With the help of an assistant, temporarily mount the spare tire to the tire carrier assembly and install a lug nut to hold the tire in place.
49. Adjust the tire mounting bracket to get the tire as close to the tire carrier as possible. Once you have determined the best location for your spare tire, tighten the hardware. If necessary, tighten one or two bolts and then remove the spare tire to provide easier access to the remaining hardware. Important **Note:** It is strongly recommended that the tire is mounted as close to the tailgate as possible.
50. Tighten all of the hardware to secure the tire mounting brackets. Torque the 1/2" hardware to 80 ft.-lbs.

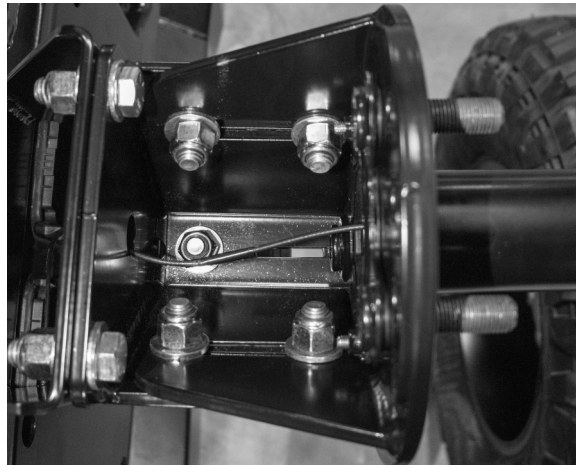

51. Open and close the tailgate to verify proper alignment and operation of the tailgate hinges. If opening or closing the tailgate requires excessive force, something is misaligned and must be addressed before the vehicle can be driven. Make adjustments as necessary until the tailgate operates smoothly. **Note:** The tire carrier can accommodate up to a 40" diameter tire with most common wheel offsets.
52. Reinstall the spare tire and fully tighten the lugs nuts.
53. Check the resistance of the tire carrier by opening and closing it with the weight of the spare tire installed and adjust the hardware referenced in step 44.

Installation Instructions

Note: Save all factory components and hardware for reuse, unless noted.

54. Install the supplied Spare Tire Support to the tire carrier assembly by completing the following steps.
- Locate the two 1/4" threaded hole locations in the tire carrier assembly directly below the center where the spare tire mounting brackets are located to find the two hole locations to mount the spare tire support brackets
 - Attach the supplied (Qty:1) Short L Shaped Spare Tire Support to the tire carrier assembly with the use of (Qty:2) 1/4"-20 x 3/4" Length Button Head Cap Screws. (Image 54-B)
 - Attach either (Qty:1) Short L Shaped Spare Tire Support or (Qty:1) Long L Shaped Spare Tire Support to the support installed in step 54-B with the use of (Qty:2) 1/4"-20 x 3/4" Length Button Head Cap Screws, (Qty:4) 1/4" SAE Flat Washer, and (Qty:2) 1/4"- 20 Grade 8 Hex Lock Nut. Tighten until the brackets are seated against one another but still can be moved back and forward. (**Note:** The backspacing and width of the wheel and tire will determine what bracket is needed to support the spare tire. (Image 54-C)
 - Press the Spare Tire Support firmly against the spare tire and tighten the hardware installed in step 54-C.

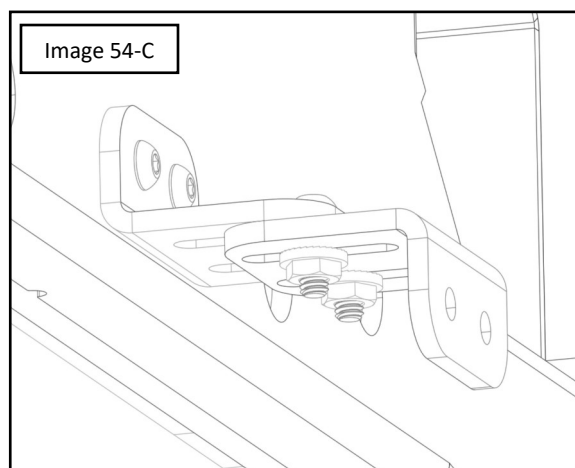
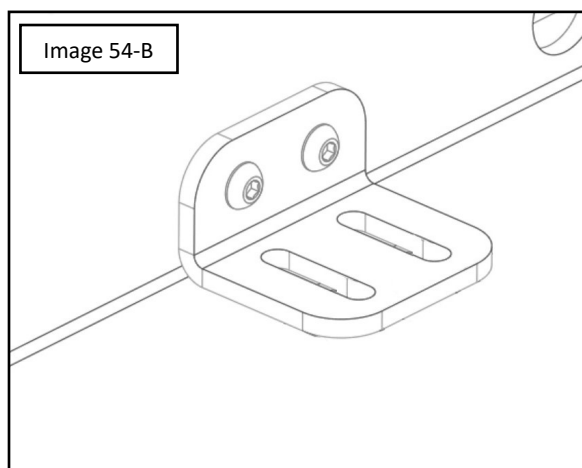

55. The installation is now complete!

Installation Instructions

WARNING

It is the owners' responsibility to inspect all Rusty's products for proper torque specs to prevent loosening of components. Seat belts and shoulder harnesses should be worn at all times. Re-check all bolts and nuts after the first 300 miles and after any off-road usage during the first 300 miles. Although all of our products are made from the highest quality materials possible, they are not a substitute for Safe and Careful driving. In other words, have good safe on-road / off-road sense. Know the terrain, the speed limitations, and any obstacles that may lie ahead. Please remember to preserve our right to enjoy public land through the proper use of off-road vehicles. Thank you for choosing Rusty's Off Road Products.