



300 HUEY LENARD LOOP | WEST MONROE | LA 71292
 OFFICE: 318-397-3000 | FAX: 318-397-3040
 SERVICE & TECH SUPPORT: 800-551-4955
 SUPERLIFT.COM



2018-2019 JEEP WRANGLER 2.5 Inch Lift Kits INSTALLATION INSTRUCTIONS

Engineered for 4WD Models.

- Fits:** 2018-2019 Jeep Wrangler JL Sport 2-Door 4WD
 2018-2019 Jeep Wrangler JL Sport S 2-Door 4WD
 2018-2019 Jeep Wrangler JL Rubicon 2-Door 4WD
 2018-2019 Jeep Wrangler JL Unlimited Sport 4-Door 4WD
 2018-2019 Jeep Wrangler JL Unlimited Sport S 4-Door 4WD
 2018-2019 Jeep Wrangler JL Unlimited Sahara 4-Door 4WD
 2018-2019 Jeep Wrangler JL Unlimited Rubicon 4-Door 4WD
 2019 Jeep Wrangler JL Unlimited Moab 4-Door 4WD



CAUTION: MAKE SURE YOU HAVE THE CORRECT LIFT FOR YOUR VEHICLE:

Double check the Year, Make, Model, Lift Height and KIT Part Numbers.

NOTE: Prior to beginning the installation, OPEN the Boxes and CHECK the Included Components Compared to the Parts Breakdown. Check all parts and hardware in the box with the parts list below. Be sure you have all needed parts and know where they install.

IF you find a packaging error, contact SUPERLIFT directly. Do not contact the dealer where the system was originally purchased. You will need the control number from each box when calling; this number is located at the bottom of the part number label and to the right of the bar code.

- ① Coil Spring, Rear, PA Side
- ② Coil Spring, Rear DR Side
- ③ Bump Stops, Rear, DR & PA Side
- ④ Sway Bar Links, Rear, DR & PA Side
- ⑤ Coil Spring, Front, PA Side
- ⑥ Sway Bar Links, Front, DR & PA Side
- ⑦ Coil Spring, Front, DR Side
- ⑧ Shock Spacers, Rear, DR & PA Side
- ⑨ Bump Stops, Front, DR & PA Side
- ⑩ Shock Spacers, Front, DR & PA Side

NOTE: K185 | 2.5 Inch Lift with Dual Rate Coils & Shock Spacers Shown

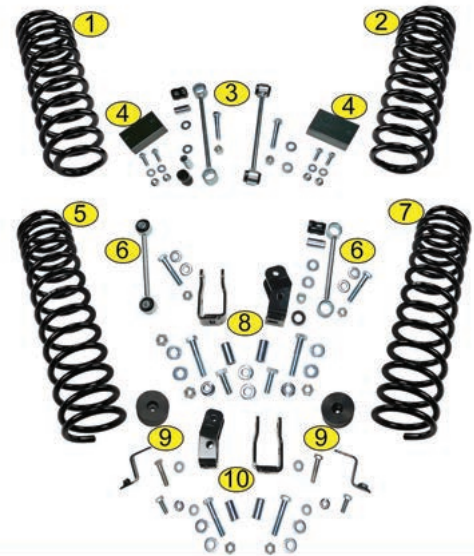

- ① Coil Spring, Rear, PA Side
- ② Coil Spring, Rear DR Side
- ③ Bump Stops, Rear, DR & PA Side
- ④ Sway Bar Links, Rear, DR & PA Side
- ⑤ Coil Spring, Front, PA Side
- ⑥ Sway Bar Links, Front, DR & PA Side
- ⑦ Coil Spring, Front, DR Side
- ⑧ Bump Stops, Front, DR & PA Side
- ⑨ FOX Shocks, Rear, DR & PA Side
- ⑩ FOX Shocks, Front, DR & PA Side

NOTE: K185F | 2.5 Inch Lift with Dual Rate Coils & FOX Shocks Shown



| HARDWARE BAG BREAKDOWN | | | | | |
|-------------------------|------|--|--------------------------|------|--------------------------------------|
| Kit Part Number 77-5800 | | | Kit Part Number 77-5801A | | |
| Part Number | Qty. | Part Description | Part Number | Qty. | Part Description |
| 12C5FN | 2 | 1/2" Nut, Flange Coarse Thread | 12MNN | 4 | 12mm Nut, Nyloc Coarse Thread |
| 12C5NN | 4 | 1/2" Nut, Nyloc Coarse Thread | 12MFW | 8 | 12mm Flat Washer |
| 12SW | 10 | 1/2" Washer, SAE | 12MX1.75X70CS | 2 | 12mm x 70mm Bolt, 1.75 Coarse Thread |
| 12X112C8CS | 2 | 1/2" x 1-1/2" Bolt, Coarse Thread | 12MX1.75X80CS | 2 | 12mm x 80mm Bolt, 1.75 Coarse Thread |
| 12X312C8CS | 4 | 1/2" x 3-1/2" Bolt, Coarse Thread | | | |
| 24-5704 | 4 | Sleeve, 0.75" OD x 0.50" ID x 1.50" Long | Kit Part Number 77-5802 | | |
| 38C5FN | 2 | 3/8" Flange Nut, Coarse Thread | Part Number | Qty. | Part Description |
| 38SW | 2 | 3/8" Washer, SAE | 38C5FN | 4 | 3/8" Flange Nut, Coarse Thread |
| 38X114C8CS | 2 | 3/8" x 1-1/4" bolt, Coarse Thread | 38SW | 6 | 3/8" Washer, SAE |
| | | | 38X134C8CS | 6 | 3/8" x 1-3/4" Bolt, Coarse Thread |
| | | | 55-08-5800 | 2 | 3/8" Nut, Tab |
| Kit Part Number 77-5801 | | | | | |
| Part Number | Qty. | Part Description | | | |
| 01-60418 | 8 | Bushing, Hourglass | | | |
| 24-5704 | 8 | Sleeve, 0.75" OD x 0.50" ID x 1.50" Long | | | |

INTRODUCTION BEFORE INSTALLATION...

Installation requires a professional mechanic. In addition to these instructions, professional knowledge of disassembly / reassembly procedures and post installation checks must be known.

PRIOR to beginning, inspect the vehicles steering, driveline, and brake systems, paying close attention to the suspension link arms and bushings, sway bars and bushings, tie rod ends, pitman arm, idler arm, ball joints and wheel bearings. Also check the steering sector-to-frame and all suspension-to-frame attaching points for stress cracks. The overall vehicle must be in excellent working condition; repair or replace all worn parts.

Read instructions several times before starting.

Read each step completely as you go.

Be sure you have all needed parts and know where they install.

NOTES:

- Front end alignment is necessary.
- Tool and Wrench/Socket size is given in brackets [] after each appropriate step.
- A foot-pound torque reading is given in parenthesis () after each appropriate fastener.
- Always wear safety glasses when using power tools.
- Prior to attaching components, be sure all mating surfaces are free of grit, grease, excessive undercoating, etc.
- Do not fabricate any components to gain additional suspension height.
- A factory service manual should be on hand for reference.
- Due to payload options and initial ride height variances, the amount of lift is a 'base figure'. Final ride height dimensions may vary in accordance to original vehicle stance.

BEFORE YOU DRIVE...

Check all fasteners for proper torque. Check to ensure for adequate clearance between all rotating, mobile, fixed, and heated members. Verify clearance between exhaust and brake lines, fuel lines, fuel tank, floor boards and wiring harness. Check steering components for clearance.

Test and inspect brake system. Perform steering sweep to ensure front brake hoses have adequate slack and do not contact any rotating, mobile or heated members. Inspect rear brake hoses at full extension for adequate slack. Failure to perform hose check/replacement may result in component failure.

Perform head light check and adjustment.

 WARNING: It is the ultimate buyer's responsibility to have all bolts / nuts checked for tightness after the first 100 miles and then every 1000 miles. The steering, suspension and driveline systems, plus wheel alignment should be inspected by a qualified professional mechanic at least every 3000 miles.

TIRES & WHEELS...

Larger rim and tire combinations may increase leverage on suspension, steering, and related components. When selecting combinations larger than OE, consider the additional stress you could be inducing on the OE and related components.

NOTE: Stock 17", 18" and 20" Wheels Will Fit back on the vehicle once this suspension system is installed.

WARNING: ANY larger or wider tire & wheel combination other than listed Will Require Vehicle Trimming.

IMPORTANT DISCLAIMER: The provided tire/wheel fitments are approximate. Actual dimensions of a given tire size can vary considerably from one brand to another. Manufacturers' wheel offset and backspacing measurement points are not always consistent. Backspacing greatly impacts tire-to-fender clearance when turning. Wheel width and backspacing influence whether the tires protrude past the fenders, and to what extent. Considering these important factors, we recommend that you fit-check your tire/wheel selection prior to purchasing.

| 2.5 Inch - TIRE SIZE SPECIFICATIONS | | | |
|-------------------------------------|--------|--------------------|---------------|
| Tire Size | Wheel | Backspacing (INCH) | Offset (MM) |
| 33 x 12.50 R17 | 17 x 9 | 4.00 - 4.75 | -24mm -12mm |
| 305/65 R17 | 17 x 9 | 4.00 - 4.75 | -24mm -12mm |
| 33 x 12.50 R18 | 18 x 9 | 4.00 - 4.75 | -24mm -12mm |
| 325/60 R18 | 18 x 9 | 4.00 - 4.75 | -24mm -12mm |
| 33 x 12.50 R20 | 20 x 9 | 4.00 - 4.75 | -24mm -12mm |
| 305/55 R20 | 20 x 9 | 4.00 - 4.75 | -24mm -12mm |

Maximum BS/Offset Listed

| RUBICON ONLY 2.5 Inch - TIRE SIZE SPECIFICATIONS | | | |
|--|--------|--------------------|---------------|
| Tire Size | Wheel | Backspacing (INCH) | Offset (MM) |
| 35x12.50 R17 | 17 x 9 | 4.00 - 4.75 | -24mm -12mm |
| 315/70R17 | 17 x 9 | 4.00 - 4.75 | -24mm -12mm |
| 35x12.50 R18 | 18 x 9 | 4.00 - 4.75 | -24mm -12mm |
| 315/70R18 | 18 x 9 | 4.00 - 4.75 | -24mm -12mm |
| 35x12.50 R20 | 20 x 9 | 4.00 - 4.75 | -24mm -12mm |
| 315/60 R20 | 20 x 9 | 4.00 - 4.75 | -24mm -12mm |

Maximum BS/Offset Listed

TOOLS & TECH...

The chart is a listing of the main tools need to install this lift kit system.

We have also included a **Tech Tip** noted by this icon  **TECH TIP** to help if we have found a quicker or easier way to accomplish a task in the steps.

| Tools | | | |
|-------------------------------|----------------|-----------------------|-----------|
| Miscellaneous Tools | | Wrench / Socket Sizes | |
| Floor Jacks | Jack Stands | Standard | Metric |
| Adjustable Pliers | | 9/16" | 8mm 19mm |
| Torque Wrench | | 5/8" | 13mm 21mm |
| Flathead Screwdriver | | 3/4" | 15mm 22mm |
| Ball Peen Hammer | | 13/16" | 18mm 24mm |
| Drill | 1/2" Drill Bit | 7/8" | |
| Plastic Fastener Removal Tool | | | |
| Tie Rod Puller Tool | | | 6mm Allen |

| TORQUE SPECIFICATIONS | | | | | |
|-----------------------|-------------|-------------|--------|-------------|-------------|
| STANDARD | | | METRIC | | |
| Size | Grade 5 | Grade 8 | Size | Grade 8.8 | Grade 10.9 |
| 5/16" | 15 ft/lbs. | 20 ft/lbs. | 6mm | 5 ft/lbs. | 9 ft/lbs. |
| 3/8" | 30 ft/lbs. | 35 ft/lbs. | 8mm | 18 ft/lbs. | 23 ft/lbs. |
| 7/16" | 45 ft/lbs. | 60 ft/lbs. | 10mm | 32 ft/lbs. | 45 ft/lbs. |
| 1/2" | 65 ft/lbs. | 90 ft/lbs. | 12mm | 55 ft/lbs. | 75 ft/lbs. |
| 9/16" | 95 ft/lbs. | 130 ft/lbs. | 14mm | 85 ft/lbs. | 12 ft/lbs. |
| 5/8" | 135 ft/lbs. | 175 ft/lbs. | 16mm | 130 ft/lbs. | 165 ft/lbs. |
| 3/4" | 185 ft/lbs. | 280 ft/lbs. | 18mm | 170 ft/lbs. | 240 ft/lbs. |

| STEP | PART NUMBER | QTY. PER KIT | DESCRIPTION | NEW ATTACHING HARDWARE | QTY. PER BRACKET | HARDWARE BAG NUMBER |
|-----------|-------------|--------------|--|--|------------------|---------------------|
| 13 | 55-17-5825 | 2 | Bump Stop, Front | 3/8" x 1-1/4" Bolt, Coarse Thread | 1 | 77-5802 |
| | | | | 55-08-5800 - 3/8" Nut, Tab | 1 | |
| | | | | 3/8" Washer, SAE | 1 | |
| 13 | 01-585 | 1 | 2.5" Coil Spring, Front Driver Side | | | |
| | 02-585 | 1 | 2.5" Coil Spring, Front Passenger Side | | | |
| OR | | | | | | |
| 13 | 01-587 | 1 | 2.5" Dual Rate Coil Spring, Front Driver Side | | | |
| | 02-587 | 1 | 2.5" Dual Rate Coil Spring, Front Passenger Side | | | |
| OR | | | | | | |
| 13 | 01-589 | 1 | 2.5" Dual Rate Coil Spring, Front Driver Side | | | |
| | 02-589 | 1 | 2.5" Dual Rate Coil Spring, Front Passenger Side | | | |
| 15 | 55-13-5825 | 2 | Shock Spacer, Front | 24-5704 Sleeve, 0.75" OD x 0.50" ID x 1.50" Long | 1 | 77-5800 |
| | | | | 3/8" x 1" Bolt, Coarse Thread | 1 | |
| | | | | 1/2" x 3-1/2" Bolt, Coarse Thread | 1 | |
| | | | | 1/2" Washer, SAE | 2 | |
| | | | | 3/8" Flange Nut, Coarse Thread | 1 | |
| | | | | 1/2" Nut, Nyloc Coarse Thread | 1 | |
| | | | | 3/8" Washer, SAE | 1 | |
| OR | | | | | | |
| 16 | 985-24-177 | 2 | FOX Shocks, Front | | | |
| 22 | 55-16-5825 | 2 | Sway Bar Link, Front | 01-60418 - Bushing, Hourglass | 2 | 77-5801 |
| | | | | 24-5704 - Sleeve, 0.75" OD x 0.50" ID x 1.50" Long | 2 | |
| | | | | 12mm x 80mm Bolt, 1.75 Coarse Thread | 1 | 77-5801A |
| | | | | 12mm Flat Washer | 2 | |
| | | | | 12mm Nut, Nyloc Coarse Thread | 1 | |
| 36 | 55-07-5825 | 2 | Bump Stop, Rear | 3/8" x 1-3/4" Bolt, Coarse Thread | 2 | 77-5802 |
| | | | | 3/8" Washer, SAE | 4 | |
| | | | | 3/8" Flange Nut, Coarse Thread | 2 | |
| 37 | 01-593 | 1 | 2" Coil Spring, Rear Driver Side | | | |
| | 02-593 | 1 | 2" Coil Spring, Rear Passenger Side | | | |
| OR | | | | | | |
| 37 | 01-596 | 1 | 2" Dual Rate Coil Spring, Rear Driver Side | | | |
| | 02-596 | 1 | 2" Dual Rate Coil Spring, Rear Passenger Side | | | |
| OR | | | | | | |
| 37 | 01-591 | 1 | 2" Dual Rate Coil Spring, Rear Driver Side | | | |
| | 02-591 | 1 | 2" Dual Rate Coil Spring, Rear Passenger Side | | | |
| 38 | 55-14-5825 | 2 | Shock Spacer, Rear | 24-5704 - Sleeve, 0.75" OD x 0.50" ID x 1.50" Long | 1 | 77-5800 |
| | | | | 1/2" x 1-1/2" Bolt, Coarse Thread | 1 | |
| | | | | 1/2" Washer, SAE | 3 | |
| | | | | 1/2" Nut, Flange Coarse Thread | 1 | |
| | | | | 1/2" x 3-1/2" Bolt, Coarse Thread | 1 | |
| | | | | 1/2" Nut, Nyloc Coarse Thread | 1 | |
| OR | | | | | | |
| 39 | 985-24-178 | 2 | FOX Shocks, Rear | | | |
| 40 | 44-17-5050 | 2 | Sway Bar link, Rear | 01-60418 - Bushing, Hourglass | 2 | 77-5801 |
| | | | | 24-5704 - Sleeve, 0.75" OD x 0.50" ID x 1.50" Long | 2 | |
| | | | | 12mm x 70mm Bolt, 1.75 Coarse Thread | 1 | 77-5801A |
| | | | | 12mm Flat Washer | 2 | |
| | | | | 12mm Nut, Nyloc Coarse Thread | 1 | |

NOTE: Use the check-off box found at each step to help you keep your place. Two denotes that one check-off box is for the Driver Side (Left) and one is for the Passenger Side (Right). Unless otherwise noted, always start with the Driver Side.

FRONT DISASSEMBLY

NOTE: Save ALL factory components and hardware for reuse, unless noted.

TECH TIP As you uninstall OEM parts, Place the Factory Hardware Back into the Factory Location. This will save you time and make the install easier to complete.

PREPARE VEHICLE FOR FRONT...

- Disconnect the battery.
- Chock rear tires and place transmission in neutral. Raise the front of vehicle with a jack and secure a jack stand beneath each frame rail. Ease the frame down onto the stands, place transmission in Low Gear for Manual Transmission or Park for Automatic. Remove the front wheels & tires. [Lug Nuts 22mm Deep Well Socket]

REMOVE SWAY BAR LINKS...

- [Illustration 1] Remove the factory hardware from the lower sway bar link mount at the axle mount. [Bolt: 18mm, Nut: 18mm] Retain factory hardware.
- [Illustration 1] Remove the factory hardware from the upper sway bar link at the sway bar. [6mm Allen and an 18mm wrench]

DISCONNECT TRACK BAR AT AXLE MOUNT...

- [Illustration 2] Remove the factory bolt and tab nut from the track bar at the lower axle mount. [21mm] Retain the factory hardware.

RUBICONS: DISCONNECT FRONT LOCKER...

- [Illustration 3] **RUBICON Models:** The front locker must be disconnected so the wiring connectors are not over-extended.

On the Driver Side located on the 'inner' frame rail above the axle, Unplug the harness plug. Unclip the wiring harness clips from the frame. [Plastic Fastener Removal Tool]

Illustration 2



Illustration 1

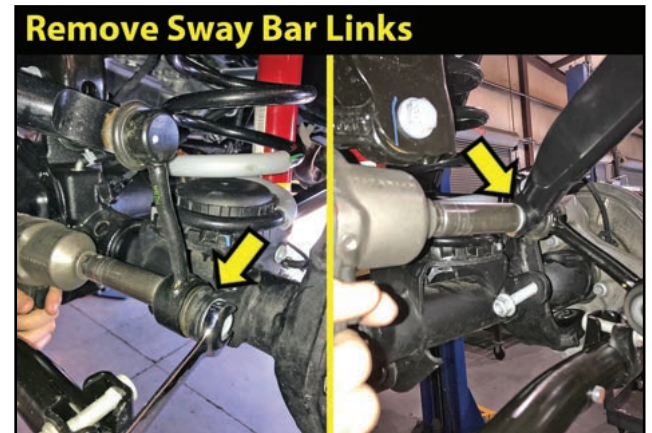

Illustration 3



UNCLIP CENTER AXLE DISCONNECT (CAD)...

5. [Illustration 4] The Center Axle Disconnect or otherwise known as the CAD, must be disconnected so the wiring connectors are not over-extended.

On the Passenger Side located on the 'inner' frame rail above the axle, remove the zip tie from the wiring harness. Unclip the wiring harness clips from the frame. [Plastic Fastener Removal Tool]

At the Passenger Side axle, unplug the CAD harness. Unclip wiring clips from front axle. [Plastic Fastener Removal Tool] **NOTE:** Make sure there is adequate slack on all wires.

Illustration 4**REMOVE BRAKE LINE BRACKET...**

6. [Illustration 5] On the Driver Side & Passenger Side, remove the brake line bracket from the lower control arm. [15mm]

DISCONNECT FRONT DRIVESHAFT...

7. [Illustration 6] Make an alignment mark on the front driveshaft and front differential input yoke.

Remove the four bolts from the yoke. [15mm] Save the driveshaft hardware.

Remove the front driveshaft from the differential. Secure the driveshaft safely up and out of the way with a bungee, mechanic's wire or other method.

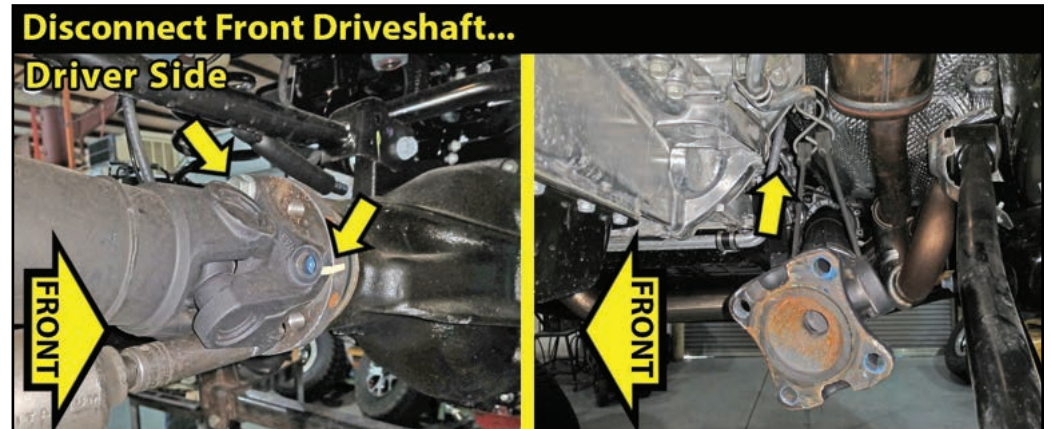
Illustration 5**Illustration 6****DISCONNECT FRONT AXLE VENT TUBE...**

8. [Illustration 7] Locate the brake line bracket attached on the Driver Side frame to the rear of the shock tower. [Plastic Fastener Removal Tool] Unclip the axle vent hose clip from the brake line bracket. Follow the vent tube up and unclip the frame attachment. [Plastic Fastener Removal Tool] Continue to follow the vent tube up and unclip from the shock tower that is behind the wheel well plastic. [Plastic Fastener Removal Tool]

Illustration 7

Disconnect Front Axle Vent Tube...

Driver Side

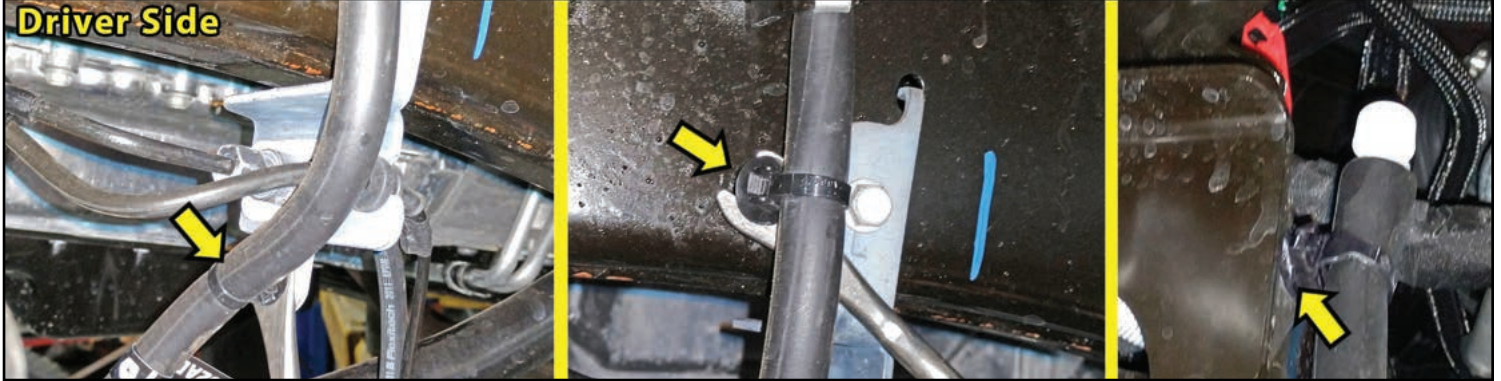

REMOVE FRONT SHOCKS...

9. □□ [Illustration 8]

⚠️ NOTE: If you are installing the Shock Spacer Kit, disconnect the Lower Shock Mount ONLY.

Disconnect the shock from the upper shock tower mount. [18mm socket]

Disconnect the shock from the lower mount at the axle. [18mm wrench \ 18mm socket]

Remove shocks. Retain the shocks and shock mount hardware.

Illustration 8

Remove Front Shocks...

Driver Side

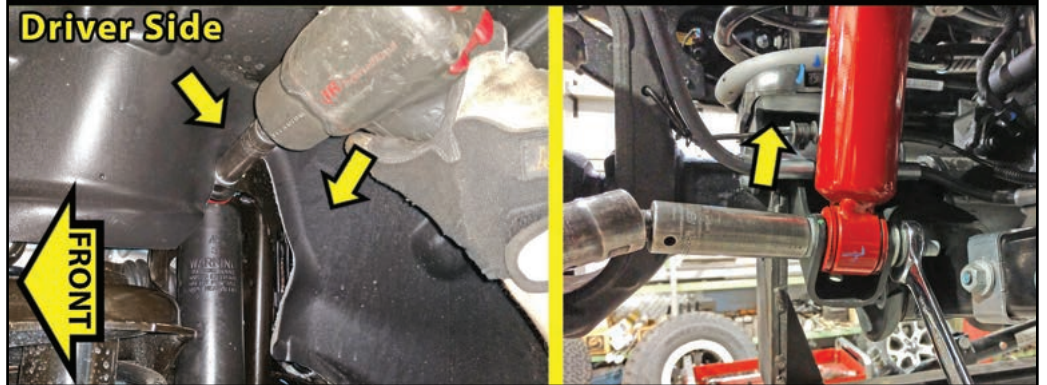

REMOVE FRONT COIL SPRINGS...

10. □□ [Illustration 9] Lower the axle enough to facilitate removing the front coil springs. Remove the coil springs.

REMOVE OEM LOWER CONTROL ARMS...

11. □□ [Illustration 10] Disconnect lower control arms from the front factory mounts. [21mm & 24mm] Remove OEM lower control arms.

DISCONNECT BRAKE LINE...

12. □□ [Illustration 11] Disconnect factory brake line bracket from axle coil spring seat. [10mm] Pull bracket rearward to allow clearance. **⚠️ NOTE:** Do not over extend brake lines or ABS lines.

Illustration 9

Remove Front Coils...

Driver Side



Illustration 10

Remove OEM Lower Control Arms...



Illustration 11

Disconnect Brake Bracket...

Driver Side



FRONT ASSEMBLY

INSTALL FRONT BUMP STOP EXTENSIONS & COIL SPRINGS...

13. □□ [Illustration 12] Locate the (2) SUPERLIFT front bump stops (#55-17-5800).

Locate Hardware Bag #77-5802. Hardware PER Side: (1) 3/8" x 1-1/4" Bolt, Coarse Thread, (1) 3/8" SAE Washer & (1) #55-08-5800 - 3/8" Nut, Tab

Insert the washer onto the 1-1/4" bolt. Insert the bolt into the top of the bump stop noted by the recessed hole.

Locate the (2) SUPERLIFT front coil springs. They are Driver and Passenger side specific.

Place the bump stop inside of the side specific coil spring. Install the front coil spring with the bump stop inside. Insert the coil spring into the upper tower first. Be sure that the coils are indexed so they seat properly then raise the axle enough to hold the coil springs in place. **TECH TIP** If the front axle cannot be lowered enough to allow the coil spring to be installed, carefully rotate the pinion up to provide more clearance for the coil installation.

The lower coil spring mount pad has a factory hole in the center. Align the bump stop bolt into the hole.

Reach under the spring mount pad and above the axle tube to start the #55-08-5800 - 3/8" tab nut onto the bump stop bolt. Tighten bump stop into place. [9/16" socket] (25)

TECH TIP On the Passenger Side, it may be necessary to remove the ABS bracket to install the tab nut. At the rear of the axle above the shock mount, remove the ABS mounting bracket. [10mm]

Once bump stop spacer is tight, reinstall ABS line mounting bracket onto axle. [10mm]

Illustration 12

Install Front Bump Stop & Coil Springs...

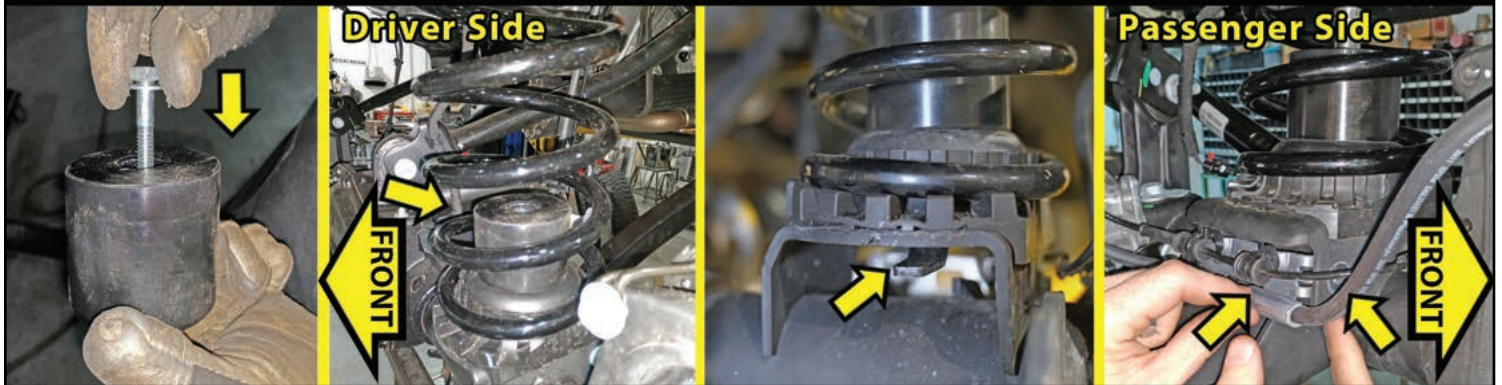

RECONNECT BRAKE LINE...

14. □□ [Illustration 13] Reconnect factory brake line bracket from axle coil spring seat. [10mm]

Illustration 13



INSTALL FRONT SHOCK SPACER INSTALL...

NOTE: IF you are installing the FOX front shocks, Proceed to Step 16.

15. □□ [Illustration 14] Locate the (2) SUPERLIFT front shock spacers (#55-13-5825). They are not side specific. Locate Hardware Bag #77-5800. Hardware PER Side: (1) #24-5704 Sleeve, 0.75" OD x 0.50" ID x 1.50" Long, (1) 3/8" x 1-1/4" Bolt, Coarse Thread, (1) 3/8" SAE Washer, (1) 3/8" Flange Nut, Coarse Thread (1) 1/2" x 3-1/2" Bolt, Coarse Thread, (1) 1/2" SAE Washer & (1) 1/2" Nyloc Nut, Coarse Thread.

Swing the shock rearward and up out of the way. Place the SUPERLIFT front shock spacer on the factory shock mount with pointing rearward and up. Insert the 3/8" SAE washer onto the 3/8" x 1-1/4" bolt. Insert the bolt/washer up through the bottom hole of the bracket/factory mount. Install 3/8" flange nut. [9/16 wrench / 9/16 socket]

TECH TIP The bottom hole of the factory shock mount may have to be deburred before the bolt is installed easily. Use a 3/8" drill bit to deburr the hole if needed.

Attach 1/2" SAE Washer onto the 1/2" x 3-1/2" bolt. Insert the bolt pointing inward into the shock spacer/factory shock mount. Attach #24-5704 sleeve. Continue bolt through spacer/shock mount, then attach 1/2" SAE washer & 1/2" Nyloc nut. Snug tighten only. [3/4" wrench / 3/4" socket]

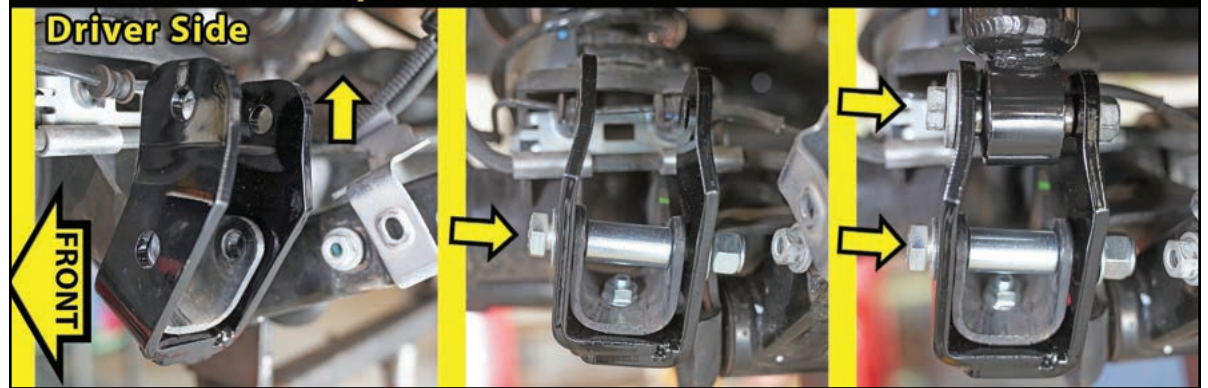
Illustration 14**Install Front Shock Spacer...**

Swing factory shock into place and align with the upper hole of the spacer. Install shock with factory hardware with the bolt pointing inward. Snug tighten only. [18mm wrench \ 18mm socket]

Shocks will be tightened completely when the vehicle is set on the ground.

FOX SHOCK INSTALL...

16. □□ [Illustration 15] Locate the #985-24-177 FOX Shocks. Install the FOX front shocks using the factory hardware at the upper shock tower mount. Tighten the upper hardware until bushings swell slightly. [18mm socket]

NOTE: The upper shock mount has a factory fixed nut in place on the frame. Be careful not to dislodge nor over tighten this nut.

Attach the shock at the lower mount at the axle using the factory hardware. [18mm wrench \ 18mm socket]

Snug tighten only. Shocks will be tightened completely when the vehicle is set on the ground.

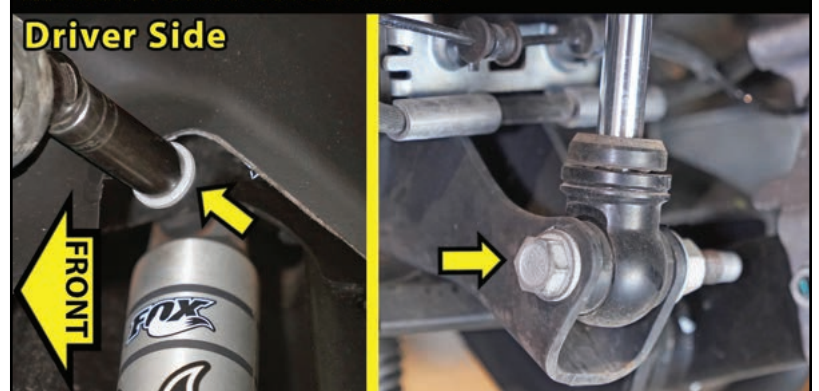
Illustration 15**Install Front FOX Shocks...**

ATTACH BRAKE LINE BRACKET TO LOWER CONTROL ARM...

17. □ □ [Illustration 16] On the Driver Side & Passenger Side, attach the brake line bracket to the lower control arm using the factory flange nut. [15mm]

REATTACH FRONT AXLE VENT TUBE...

18. □ [Illustration 17] Locate the brake line bracket attached on the Driver Side frame to the rear of the shock tower. Re-clip the axle vent hose clip to the brake line bracket. Follow the vent tube up and re-clip to the frame attachment. Continue to follow the vent tube up and re-clip to hole on the shock tower.

Illustration 16



Illustration 17

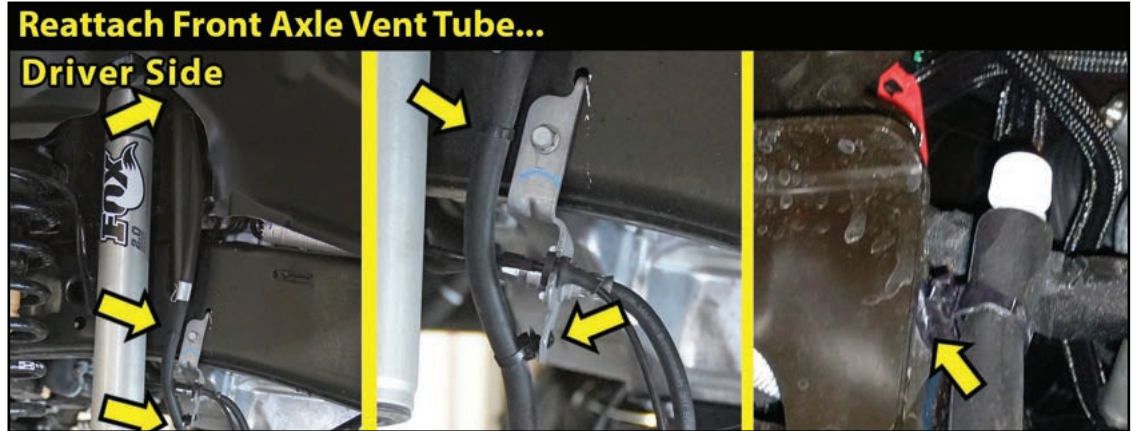

REATTACH FRONT DRIVESHAFT...

19. □ [Illustration 18] Locate the front driveshaft factory bolts. Apply thread locking compound to the factory bolt threads before installation. Align mark on the front driveshaft and front differential input yoke, reconnect the front driveshaft to the front differential. [15mm] (81)

TECH TIP With the bolts in place, use a pry bar to keep the driveshaft from turning while you tighten & torque into place.

RUBICONS: RECONNECT FRONT LOCKER...

20. □ [Illustration 19] **RUBICON Models:** On the Driver Side located on the 'inner' frame rail above the axle, re-clip the plug wiring harness together & re-clip back to the frame. Reconnect so the wiring connectors are not over-extended.

Illustration 18

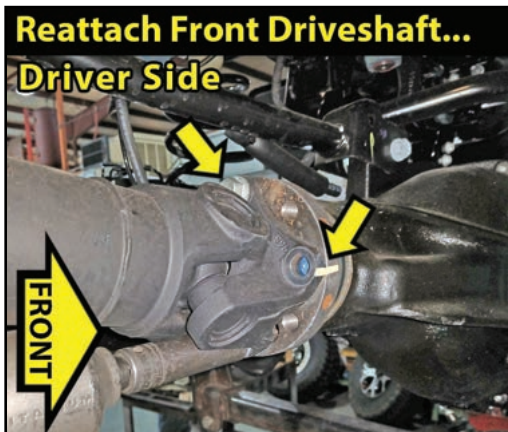
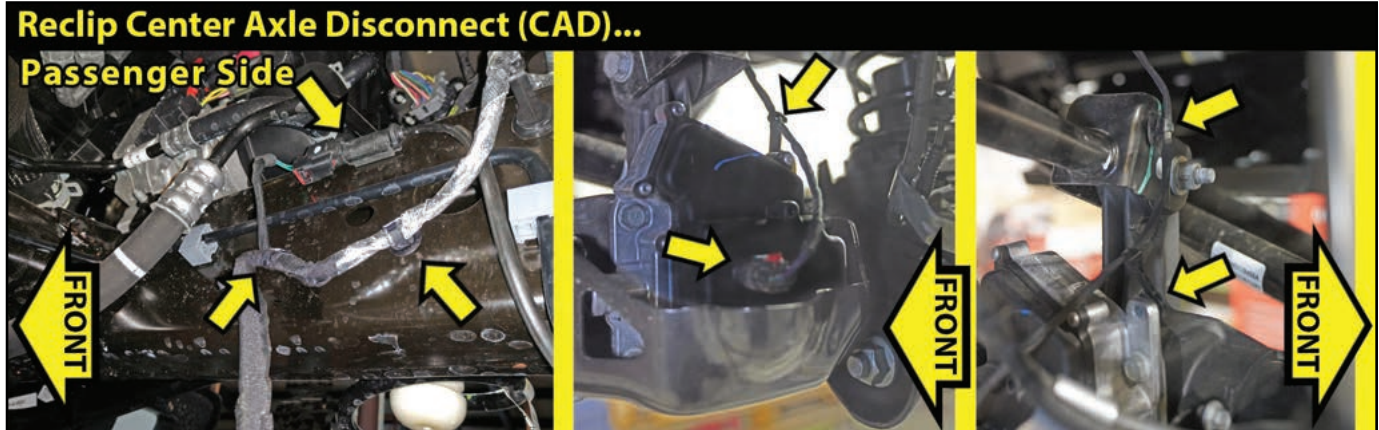

Illustration 19



RECLIP CENTER AXLE DISCONNECT (CAD)...

21. □ [Illustration 20] At the Passenger Side axle, re-plug the CAD harness. On the Passenger Side on the 'inner' frame rail above the axle, re-clip the plug wiring harness together & re-clip back to the frame. Reconnect so the wiring connectors are not over-extended.

Illustration 20**INSTALL FRONT SWAY BAR LINKS...**

22. □□ [Illustration 21] Locate the (2) SUPERLIFT front sway bar links (#55-16-5825). **NOTE:** These supplied front sway bar links are shorter than the supplied rear sway bar links.

Locate Hardware Bag #77-5801 & #77-5801A. Hardware PER Side: (2) 01-60418 - Bushing, Hourglass, (2) #24-5704 - Sleeve, 0.75" OD x 0.50" ID x 1.50" Long, (1) 12mm x 80mm Bolt, Coarse Thread, (2) 12mm Washer & (1) 12mm Nut, Nyloc Coarse Thread.

Lightly grease and install/press the hourglass shaped bushing and 0.50" ID sleeve into each end of the sway bar link end. **NOTE:** ONLY attach the upper sway bar link mount to the sway bar at this time. The lower mount will be attached to the new track bar bracket.

Attach 12mm Washer onto the 12mm x 80mm bolt. Insert the bolt pointing inward into the new sway bar link.

Continue bolt through sway bar, then attach 12mm washer & 12mm Nyloc nut. Snug tighten only. [19mm wrench / 19mm socket]

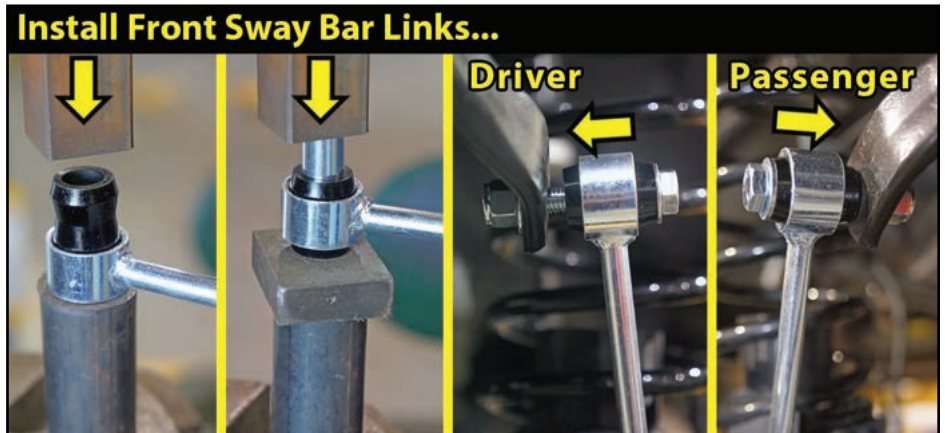
Illustration 21**FRONT TIRES / WHEELS...**

23. □□ [Illustration 22] Install the front tires & wheels. [Lug Nuts 22mm] (140) Lower the vehicle to the ground.

WARNING: When the tires / wheels are installed, always check for and remove any corrosion, dirt, or foreign material on the wheel mounting surface, or anything that contacts the wheel mounting surface (hub, rotor, etc.). Installing wheels without the proper metal-to-metal contact at the wheel mounting surfaces can cause the lug nuts to loosen and the wheel to come off while the vehicle is in motion.

□ Reconnect the battery.

Illustration 22

Lug Nut Torque Sequence...
Follow the Sequence Below to Torque the Lug Nuts

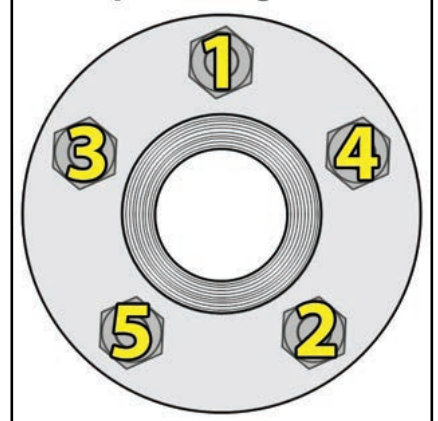

INITIAL FRONT CLEARANCE CHECK...

24. ☐☐ With the vehicle on the ground, cycle the steering lock-to-lock and check all components for proper operation and clearances. Pay special attention to the clearance between the tires / wheels and control arms, brake hoses, ABS wiring, etc.

☐☐ Raise the vehicle back onto jack stands and secure as per **Step 1**. With the suspension 'hanging' at full extension travel, cycle the steering lock-to-lock and check all components for proper operation and clearances. Pay special attention to the clearance between the tires / wheels and control arms, brake hoses, ABS wiring, driveshaft-to-crossmember, etc.

Lower vehicle to the floor. Final tightening and adjustments to the front suspension installation will take place once rear lift is completed.

REAR INSTALLATION **⚠ NOTE:** Save ALL factory components and hardware for reuse, unless noted.

PREPARE VEHICLE FOR REAR...

25. ☐☐ Chock front tires and place transmission in neutral. Raise the rear of vehicle with a jack and secure a jack stand beneath each frame rail. Ease the frame down onto the stands, place transmission in Low Gear for Manual Transmission or Park for Automatic. Remove the rear wheels & tires. [Lug Nuts 22mm Deep Well Socket]

☐ Support the rear axle with a hydraulic jack. Leave plenty of room to lower the rear axle.

REMOVE BRAKE LINE BRACKET...

26. ☐☐ [Illustration 23] On the Driver Side & Passenger Side, remove the brake line bracket from the upper control arm bracket at the axle. [13mm]

RUBICONS: DISCONNECT REAR LOCKER...

27. ☐ [Illustration 24] **RUBICON Models:** The rear locker must be disconnected so the wiring connectors are not over-extended.

On the rear axle, unplug the locker wiring harness from the differential. Follow the wiring harness up and unclip the wiring harness clips from emergency brake cable.

Continue up the wiring harness and unclip the (2) wiring harness clips from the frame mount on the Driver Side located on the 'inner' frame rail above the axle. [Plastic Fastener Removal Tool]

Illustration 23**Illustration 24****Disconnect Rear Locker...****DISCONNECT E-BRAKE FROM AXLE HOUSING & BRAKE ASSEMBLY...**

28. ☐☐ [Illustration 25] Locate the emergency brake cable on the front of the rear axle. It runs from the center of the axle out to the brake housing. Pinch the ears of the aluminum fitting to release it from the axle mount. [Pliers] Disconnect the hook-end from the ring on the brake housing.

Illustration 25

Disconnect E-Brake Cable from Axle & Brake Assembly...

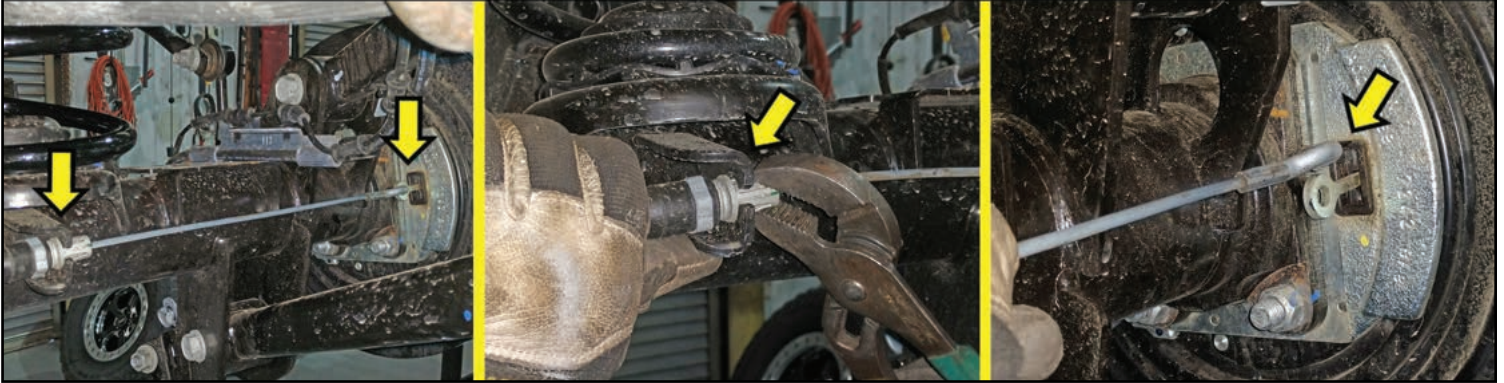

DISCONNECT REAR TRACK BAR AT THE FRAME...

29. □ [Illustration 26] Disconnect the rear track bar at the Driver Side axle mount. [21mm socket]

NOTE: There is a tab nut on the back of the bolt.

TECH TIP It may be necessary to raise or lower the axle to take the pressure off of the track bar bolt.

DISCONNECT REAR SWAY BAR LINK AT AXLE...

30. □□ [Illustration 27] Disconnect the sway bar link at the axle mount. [18mm socket / 18mm wrench]

Illustration 26



Illustration 27



DISCONNECT REAR SHOCKS AT AXLE MOUNT...

31. □□ [Illustration 28] **NOTE:** If you are installing the Shock Spacer Kit, disconnect the Lower Shock Mount ONLY. Use a 18mm wrench and 18mm socket to remove the lower shock hardware. Retain hardware.

DISCONNECT REAR SWAY BAR LINK AT SWAY BAR...

32. □□ [Illustration 29] Remove the factory hardware from the upper sway bar link at the sway bar. [6mm Allen and an 18mm wrench]

Illustration 28



Illustration 29



REMOVE REAR BUMPER INNER FENDER...

33. □□ [Illustration 30] **NOTE:** If you are installing the Shock Spacer Kit, Proceed to Step 34.

At the back of the rear fender, remove the (3) bolts retaining the rear bumper inner fender liner. [8mm socket] Retain hardware & inner liner.

DISCONNECT REAR SHOCKS AT FRAME MOUNT...

34. □□ [Illustration 31] **NOTE:** If you are installing the Shock Spacer Kit, disconnect the lower shock mount ONLY.

The upper shock mount has the nut attached to the shock mount. Disconnect the upper shock mount. [18mm]. Remove the rear shocks. Retain factory hardware.

REMOVE REAR COIL SPRINGS...

35. □□ [Illustration 32] Lower the axle enough to facilitate removing the rear coil springs. Remove the coil springs. Retain the upper factory coil spring isolator. **NOTE:** The factory upper spring isolator are Side Specific to properly align with the frame holes. MARK isolators: Driver & Passenger.

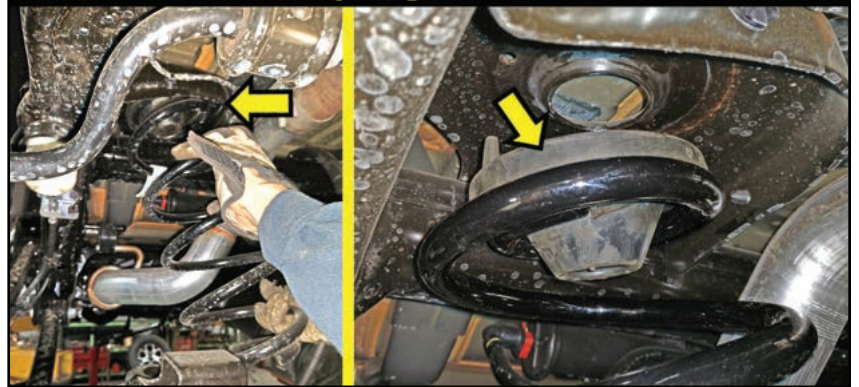
Illustration 30**Remove Rear Bumper Inner Fender... Driver Side****Illustration 31****Disconnect Rear Shock at Frame... Driver Side****Illustration 32****Remove Rear Coil Springs...****INSTALL REAR BUMP STOP SPACERS...**

36. □□ [Illustration 33] Locate the (2) SUPERLIFT rear bump stop spacers (#55-07-5800). They are not side specific. Locate Hardware Bag #77-5802. Hardware PER Side: (2) 3/8" x 1-3/4" Bolt, Coarse Thread, (2) 3/8" SAE Washers & (2) 3/8" Flange Nut, Coarse Thread.

Place the SUPERLIFT rear bump stop spacer onto the bump stop mount pad at the axle next to the coil spring mount. Insert the 3/8" SAE washer onto the 3/8" x 1-1/4" bolt. Insert the bolt/washer down through the spacer and into the factory mount. Reach under the bump stop mount pad and above the axle tube to install 3/8" flange nut at the bottom. [9/16 wrench / 9/16 socket] Tighten & torque. [30]

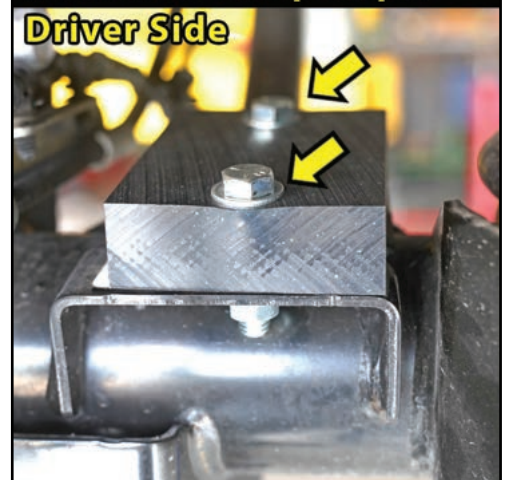
Illustration 33**Install Rear Bump Stop... Driver Side**

INSTALL REAR COIL SPRINGS...

37. ☐☐ [Illustration 34] Lower the axle enough to facilitate installing the new, taller rear coil springs. Locate the (2) SUPERLIFT rear coil springs.

Place the factory spring isolator of the side specific coil spring. **⚠ NOTE:** The factory upper spring isolator are Side Specific.

Insert the coil spring and isolator up and into the upper factory mount. Be sure that the coils are indexed so they seat properly then raise the axle enough to hold the coil springs in place.

Rotate the coils so that they seat properly in the coil buckets then raise the axle enough to seat the springs.

Illustration 34**INSTALL REAR SHOCK SPACER INSTALL...**

⚠ NOTE: IF you are installing the FOX rear shocks, Proceed to Step 39.

38. ☐☐ [Illustration 35] Locate the (2) SUPERLIFT rear shock spacers (#55-14-5825). They are not side specific. Locate Hardware Bag #77-5800. Hardware PER Side: (1) #24-5704 Sleeve, 0.75" OD x 0.50" ID x 1.50" Long, (1) 1/2" x 1-1/2" Bolt, Coarse Thread, (1) 1/2" SAE Washer, (1) 1/2" Flange Nut, Coarse Thread (1) 1/2" x 3-1/2" Bolt, Coarse Thread, (1) 1/2" SAE Washer & (1) 1/2" Nyloc Nut, Coarse Thread.

Place the SUPERLIFT rear shock spacer on the factory shock mount pointing rearward and up. Insert the 1/2" SAE washer onto the 1/2" x 1-1/2" bolt. Insert the bolt/washer up through the bottom hole of the bracket/factory mount. Install 3/8" flange nut. [3/4 wrench / 3/4 socket]

Attach 1/2" SAE Washer onto the 1/2" x 3-1/2" bolt. Insert the bolt pointing inward into the shock spacer/factory shock mount. Attach #24-5704 sleeve. Continue bolt through spacer/shock mount, then attach 1/2" SAE washer & 1/2" Nyloc nut. Snug tighten only. [3/4" wrench / 3/4" socket]

Swing factory shock into place and align with the upper hole of the spacer. Install shock with factory hardware with the bolt pointing inward. Snug tighten only. [18mm wrench \ 18mm socket]

Shocks will be tightened completely when the vehicle is set on the ground.

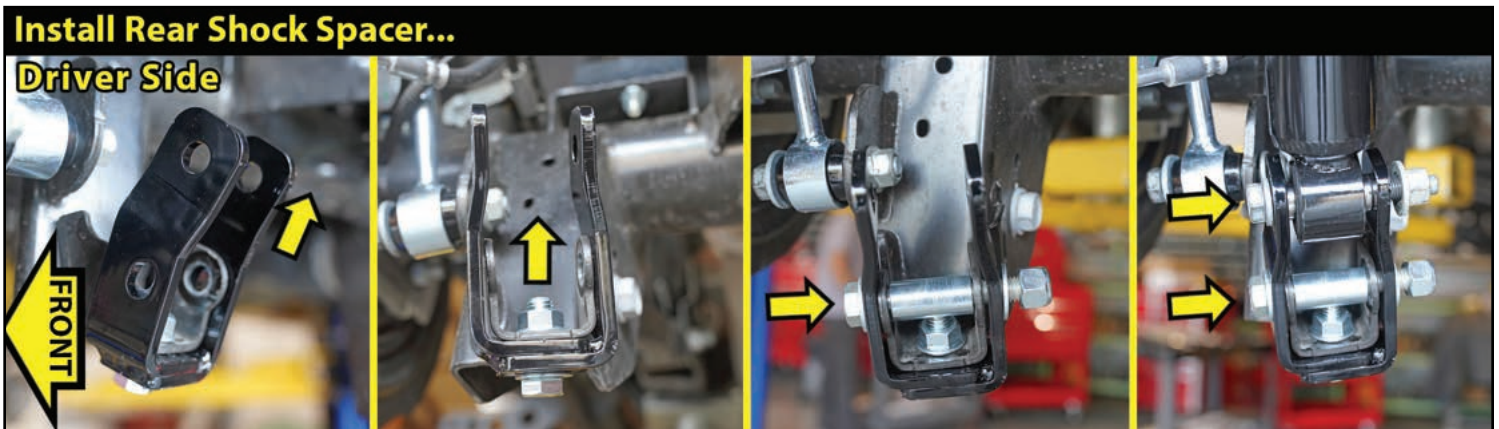
Illustration 35

INSTALL FOX SHOCK & INNER FENDER LINER...

39. ☐☐ [Illustration 36] Locate the #985-24-178 FOX Shocks.

Install the FOX shocks using the factory hardware at the upper frame mount. [18mm socket]

Install the FOX shock at the lower mount at the axle using the factory hardware with the bolt pointing inward. Snug tighten only. [18mm wrench \ 18mm socket]

Reattach the rear bumper inner fender liner using the (3) factory retaining bolts. [8mm socket]

Illustration 36**INSTALL REAR SWAY BAR LINKS...**

⚠ WARNING: Due to your selection of tire & wheel combination, SUPERLIFT has two (2) options for installing the supplied sway bar links. IF you are running factory wheels or aftermarket 17" or 18" wheels with the same width and offset/backspacing, install the sway bar links in the factory position OUTSIDE the sway bar. Aftermarket 20" or larger diameter wheels and RUBICON models should allow you to run in the factory OUTSIDE position also.

IF you have selected an aftermarket 17" or 18" wheel that is wider and/or has a more Positive offset where the wheel is closer to the sway bar, install the links as shown in the INSIDE position.

⚠ NOTE: Always check the wheel/tire clearance to the sway bar links and install per your application.

40. Locate the (2) SUPERLIFT rear sway bar links (#44-17-5050). **⚠ NOTE:** These supplied front sway bar links are longer than the supplied front sway bar links.

Locate Hardware Bag #77-5801 & #77-5801A. Hardware PER Side: (2) 01-60418 - Bushing, Hourglass, (2) #24-5704 - Sleeve, 0.75" OD x 0.50" ID x 1.50" Long, (1) 12mm x 70mm Bolt, Coarse Thread, (2) 12mm Washer & (1) 12mm Nut, Nyloc Coarse Thread.

☐☐ [Illustration 37] Lightly grease and install/press the hourglass shaped bushing and 0.50" ID sleeve into each end of the sway bar link end.

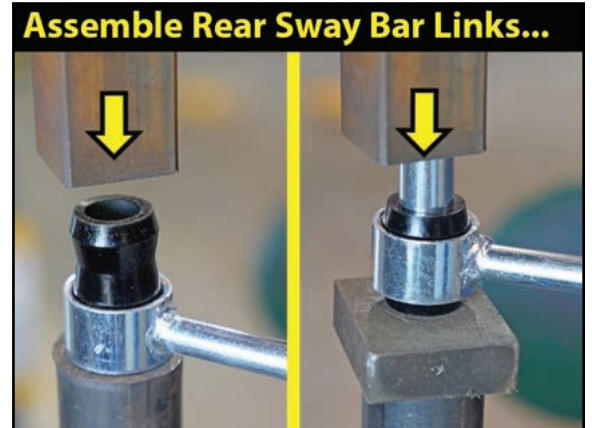
Illustration 37

To install in the factory OUTSIDE Position: Illustration 38

□□ [Illustration 38] Use the factory hardware to attach the lower sway bar link mount at the axle mount. Install bolt pointing inward. [Bolt: 18mm, Nut: 18mm]

Attach 12mm Washer onto the 12mm x 70mm bolt. Insert the bolt pointing inward into the new sway bar link. Continue bolt through sway bar, then attach 12mm washer & 12mm Nyloc nut. Snug tighten only. [19mm wrench / 19mm socket]

To install in the INSIDE Position:

□□ [Illustration 39] Use the factory hardware to attach the lower sway bar link mount at the axle mount on the inside of the mount. Install bolt pointing outward. [Bolt: 18mm, Nut: 18mm]

Attach 12mm Washer onto the 12mm x 70mm bolt. Insert the bolt pointing outward into the sway bar. Continue bolt through sway bar link, then attach 12mm washer & 12mm Nyloc nut. Snug tighten only. [19mm wrench / 19mm socket]

REATTACH BRAKE LINE BRACKET...

41. □□ [Illustration 40] Reattach the brake line bracket to the upper control arm bracket at the axle. [13mm] **NOTE:** IF you installed the sway bar links in the INSIDE position, make sure the brake lines have adequate clearance and do not chaff against the sway bar link. You should bend the factory brake line bracket slightly to gain clearance.

RUBICONS: RECONNECT REAR LOCKER...

42. □ [Illustration 41] **RUBICON Models:** On the rear axle, plug the locker wiring harness back into the differential. Follow the wiring harness up and reclip the wiring harness clips to emergency brake cable. Continue up the wiring harness and reclip the (2) wiring harness clips back to the frame mount on the Driver Side located on the 'inner' frame rail above the axle.

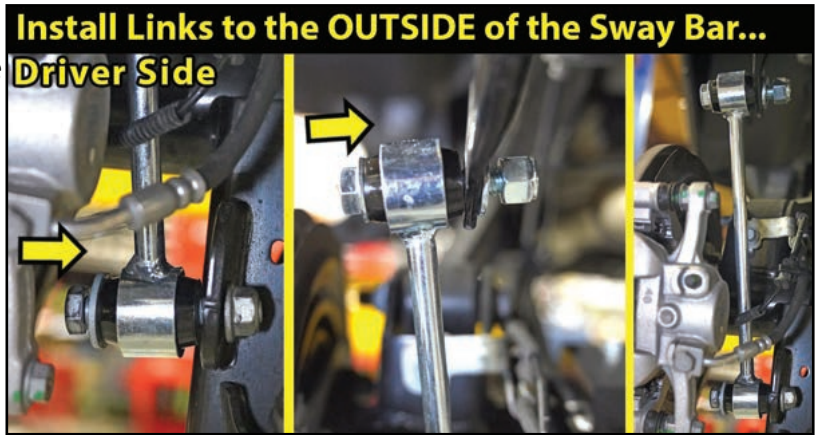
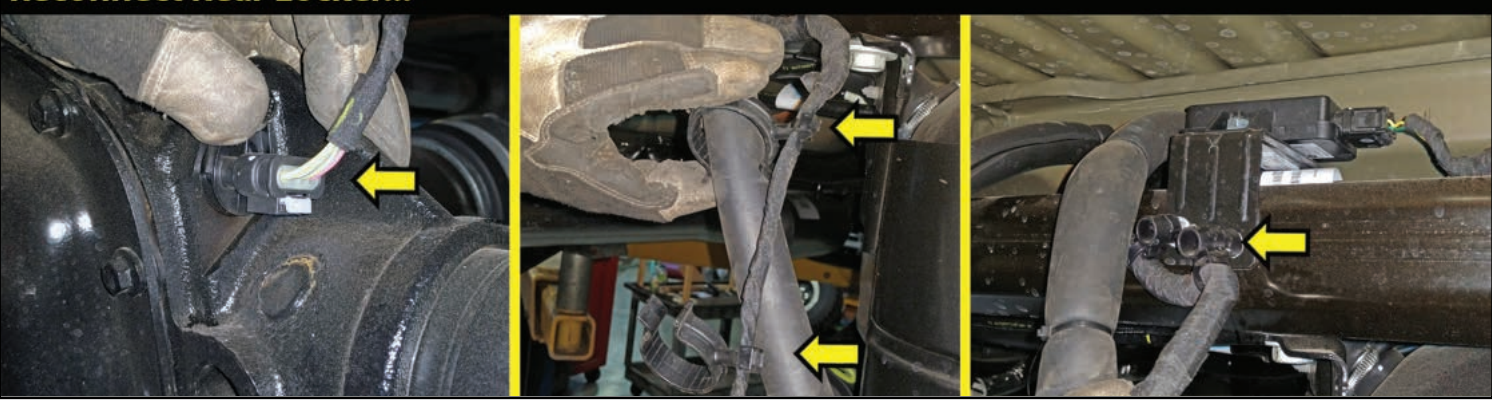
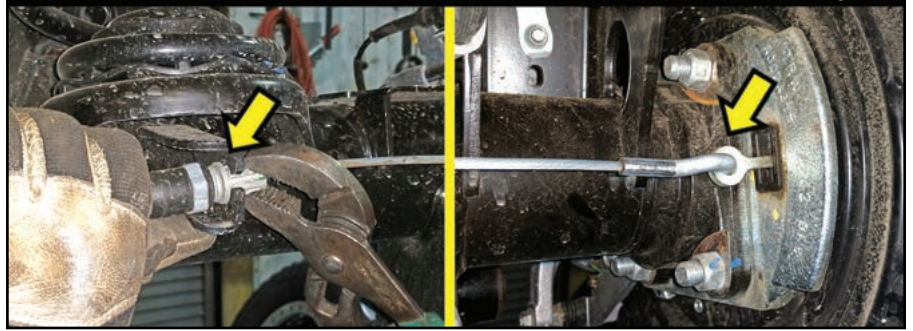

Illustration 41 Reconnect Rear Locker...



RECONNECT E-BRAKE TO AXLE HOUSING & BRAKE ASSEMBLY...

43. □□ [Illustration 42] Locate the emergency brake cable on the front of the rear axle. Pinch the ears of the aluminum fitting to clip it back into place the axle mount. [Pliers] Reconnect the hook-end to the ring on the brake housing.

Illustration 42**Reconnect E-Brake Cable to Axle & Brake Assembly...****INSTALL REAR TRACK BAR RELOCATION BRACKET...**

⚠ NOTE: 2.5" Lifts Do Not Include #5824 Rear Track Bar Relocation Bracket.

IF you the rear ends feels loose as you drive or experience tire wear at the inner or outer edges, you need to add the Optional #5824 Rear Track Bar Relocation Bracket.

44. □ [Illustration 43] Reconnect the rear track bar at the Driver Side axle mount with factory bolt and tab nut. [21mm socket]

🔧 TECH TIP A ratchet strap will help position the track bar. Attach the ratchet strap to the track bar upper frame mount & to the lower axle mount. Ratchet the strap to align the track bar with the mount hole.

Illustration 43**Reconnect Rear Track Bar at Axle...****Driver Side****Illustration 44****Lug Nut Torque Sequence...**

Follow the Sequence Below to Torque the Lug Nuts

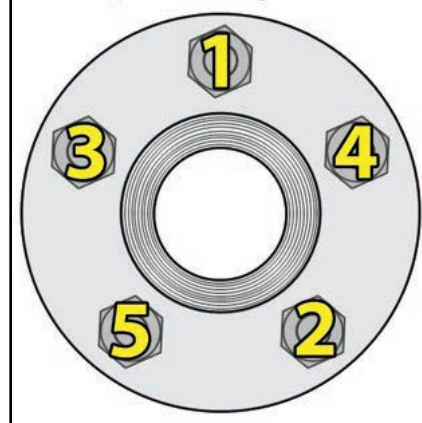
**REAR TIRES / WHEELS...**

45. □□ [Illustration 44] Install the rear tires & wheels. [Lug Nuts 22mm] (140)

⚠ WARNING: When the tires / wheels are installed, always check for and remove any corrosion, dirt, or foreign material on the wheel mounting surface, or anything that contacts the wheel mounting surface (hub, rotor, etc.). Installing wheels without the proper metal-to-metal contact at the wheel mounting surfaces can cause the lug nuts to loosen and the wheel to come off while the vehicle is in motion.

⚠ WARNING: Retighten lug nuts at 500 miles after any wheel change, or anytime the lug nuts are loosened. Failure to do so could cause wheels to come off while vehicle is in motion.

FINAL CHECKS

With the vehicle still on jack stands, and the suspension “hanging” at full extension travel, check all components for proper operation and clearances. Pay special attention to clearance between the tires / wheels and brake hoses, ABS wires, locker wiring harness, driveshaft, etc.

Lower the vehicle to the ground.

HARDWARE TIGHTENING SEQUENCE...

- 46. Front track bar bracket & track bar at axle end (125).
- Front shock spacer bracket at factory shock (55).
- Front shock spacer bracket at shock mount (55).
- Front shock spacer bracket at bottom (65).
- Front FOX shock absorber eyes (55).
- Front sway bar links, at frame and at sway bar (75).
- Rear track bar at axle end (125).
- Rear shock spacer bracket at factory shock (55).
- Rear shock spacer bracket at shock mount (55).
- Rear shock spacer bracket at bottom (65).
- Rear FOX shock absorber eyes (55).
- Rear sway bar links, at frame and at sway bar (75).

CLEARANCE CHECK...

- 47. Check all hardware for proper torque specifications.

With the vehicle on the ground, check all components for proper operation and clearances. Pay special attention to the clearance between the tires / wheels, brake hoses, wiring, etc. Check tire/wheel clearance with the fenders/bumper as well as with the steering knuckle.

WHEEL ALIGNMENT...

- 48. Realign vehicle to factory OEM specifications. It is necessary to have a proper and professional wheel alignment performed by a certified alignment technician. Align the vehicle to factory specifications. It is recommended that your vehicle alignment be checked after any off-road driving.

HEADLIGHTS...

- 49. Re-adjust headlights to proper setting. In addition to your vehicle alignment, for your safety and others, it is necessary to check and adjust your vehicle head lamps for proper aim and alignment.

FOUR WHEEL DRIVE...

- 50. Activate the four wheel drive system and check for proper engagement.

SUPERLIFT WARNING DECAL...

- 51. **⚠️ WARNING:** Install the WARNING TO DRIVER decal on the inside of the windshield, or on the dash, within Driver's view.

IMPORTANT MAINTENANCE INFORMATION

⚠️ WARNING: It is the ultimate buyer's responsibility to have all bolts / nuts checked for tightness after the first 100 miles and then every 1000 miles. The steering, suspension and driveline systems, plus wheel alignment should be inspected by a qualified professional mechanic at least every 3000 miles.

LIMITED LIFETIME WARRANTY / WARNINGS

Your SUPERLIFT® product is covered by the Limited Warranty explained below that gives you specific legal rights. This limited warranty is the only warranty SUPERLIFT® makes in connection with your product purchase. SUPERLIFT® neither assumes nor authorizes any retailer or other person or entity to assume for it any other obligation or liability in connection with this product or limited warranty.

SUPERLIFT, LLC, LIMITED LIFETIME WARRANTY

What is covered? Subject to the terms below, SUPERLIFT® will repair or replace its products found defective in materials or workmanship for so long as the original purchaser owns the vehicle on which the product was originally installed. Your warranter is SUPERLIFT, LLC, doing business as SUPERLIFT® Suspension Systems ("SUPERLIFT®").

What is not covered? Your SUPERLIFT® Limited Warranty does not cover products SUPERLIFT® determines to have been damaged by or subjected to:

- Alteration, modification or failure to maintain.
- Normal wear and tear (bushings, rod ends, etc.). Scratches or defects in product finishes (powder coating, plating, etc.).
- Damage to, or resulting from, the vehicle's electronic stability system, related components or other vehicle systems.
- Racing or other vehicle competitions or contests. Accidents, impact by rocks, trees, obstacles or other aspects of the environment.
- Theft, vandalism or other intentional damage.

Remedy Limited to Repair or Replacement. The exclusive remedy provided hereunder shall, upon SUPERLIFT's inspection and at SUPERLIFT's option, be either repair or replacement of the product covered under this Limited Warranty. Customers requesting warranty consideration should contact SUPERLIFT® by phone (1-800-551-4955) to obtain a Returned Goods Authorization number. All removal, shipping and installation costs are customer's responsibility.

If a replacement part is needed before the SUPERLIFT® part in question can be returned, you must first purchase the replacement part. Then, if the part in question is deemed warrant-able, you will be credited / refunded.

OTHER LIMITATIONS - EXCLUSION OF DAMAGES - YOUR RIGHTS UNDER STATE LAW

- Neither SUPERLIFT® nor your independent SUPERLIFT® dealer are responsible for any time loss, rental costs, or for any incidental, consequential or other damages you may have.
- This Limited Warranty gives you specific rights, and this is the only warranty SUPERLIFT® makes in connection with your product purchase. You may also have other rights that vary from state to state. For example, while all implied warranties are disclaimed herein, any implied warranty required by law is limited to the terms of our Limited Lifetime Warranty as described above. Some states do not allow limitations of how long an implied warranty lasts and / or do not allow the exclusion or limitation of incidental or consequential damages, so the limitations and exclusions herein may not apply to you. SUPERLIFT® neither assumes nor authorizes any retailer or other person or entity to assume for it any other obligation or liability in connection with this product or Limited Warranty.

IMPORTANT PRODUCT USE AND SAFETY INFORMATION / WARNINGS

⚠ WARNING: As a general rule, the taller a vehicle is, the easier it will roll over. Offset, as much as possible, what is lost in rollover resistance by increasing tire track width. In other words, go "wide" as you go "tall"; always use as wide a tire and wheel combination as feasible to enhance vehicle stability. We strongly recommend, because of rollover possibility, that the vehicle be equipped with a functional roll bar and cage system. Seat belts and shoulder harnesses should be worn at all times. Avoid situations where a side rollover may occur.

Generally, braking performance and capabilities are decreased when significantly larger / heavier tires and wheels are used. Take this into consideration while driving. Also, changing axle gear ratios or using tires that are taller or shorter than factory height will cause an erroneous speedometer reading. On vehicles equipped

with an electronic speedometer, the speed signal impacts other important functions as well. Speedometer recalibration for both mechanical and electronic types is highly recommended.

Do not add, alter, or fabricate any factory or aftermarket parts to increase vehicle height over the intended height of the SUPERLIFT® product purchased. Mixing component brands is not recommended.

WE WANT TO SEE YOUR RIDE...

Grab photos of your SUPERLIFT Equipped truck in various poses and in action.

Email pictures to us at sales@superlift.com

Tag us on **Facebook: @superlift suspension systems**

Tag us on **Instagram: #superlift, #superliftsuspension, #superliftequipped**

THANKS For Choosing SUPERLIFT...

For questions, technical support and warranty issues relating to this SUPERLIFT products, please contact SUPERLIFT directly.

**SUPERLIFT SUSPENSION
300 Huey Lenard Loop Rd.
West Monroe, Louisiana 71292
Phone: (318) 397-3000
Sales / Tech: (800) 551-4955
Fax: (318) 397-3040
SUPERLIFT.COM**